



# HEIDENHAIN



Product Information

**LC 1x3**

**LC 4x3**

Absolute Linear Encoders

November 2012

# LC 100 series

- Absolute linear encoders for measuring steps to 0.1 µm (resolution to 0.005 µm)
- High vibration rating
- Horizontal mounting possible
- Up to two additional scanning units are possible

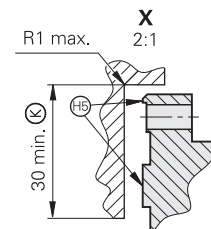
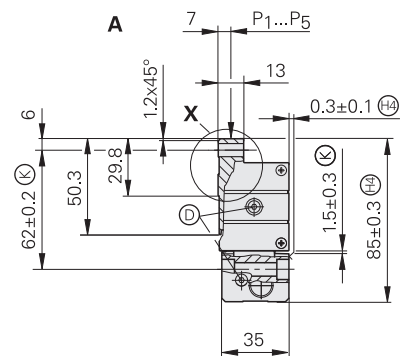
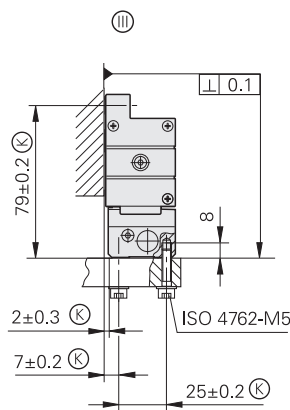
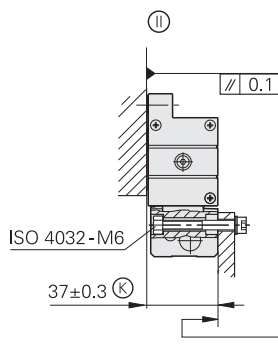
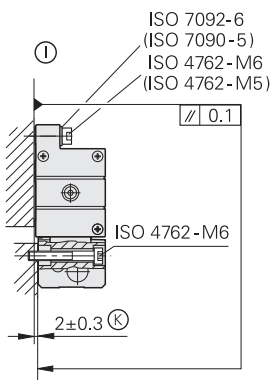
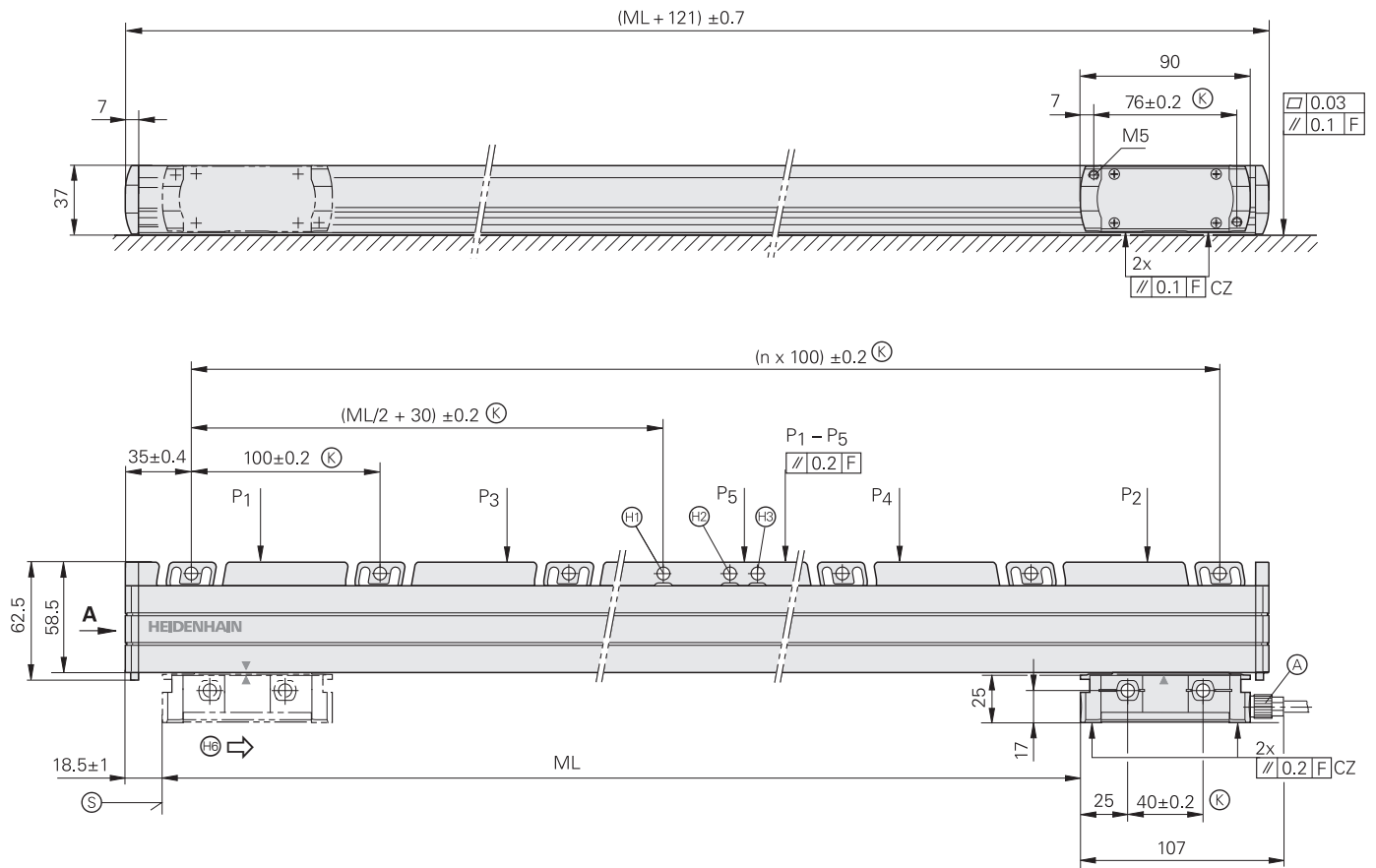

mm  
  
 Tolerancing ISO 8015  
 ISO 2768 - m H  
 < 6 mm: ±0.2 mm

- ⓪, Ⓛ, Ⓜ = Mounting options
- F = Machine guideway
- P = Gauging points for alignment
- Ⓐ = Cable connection usable at either end
- Ⓚ = Required mating dimensions
- Ⓛ = Compressed air inlet usable at either end
- Ⓜ = Beginning of measuring length ML (20 mm absolute)
- Ⓝ = Mechanical fixed point (to be preferred)
- Ⓞ = Mechanical fixed point, compatible to predecessor model
- Ⓟ = Mechanical fixed point (coincides with the spacing interval of 100 mm)
- Ⓠ = Alternative mating dimensions
- Ⓡ = Mating surfaces
- Ⓢ = Direction of scanning unit motion for output signals in accordance with interface description



Specifications	LC 183	LC 193 F	LC 193 M
<b>Measuring standard</b> Coefficient of linear expansion	DIADUR glass scale with absolute track and incremental track $\alpha_{\text{therm}} \approx 8 \times 10^{-6} \text{ K}^{-1}$		
<b>Accuracy grade*</b>	$\pm 3 \mu\text{m}$ (up to measuring length 3040); $\pm 5 \mu\text{m}$		
<b>Measuring length ML*</b> in mm	140 1540 4040	240 1640 4240	340 440 540 640 740 840 940 1040 1140 1240 1340 1440 1740 1840 2040 2240 2440 2640 2840 3040 3240 3440 3640 3840
<b>Absolute position values*</b>	EnDat 2.2 <i>Ordering designation</i> EnDat 02	Fanuc 02 serial interface	Mitsubishi high speed serial interface, Mit 02-4 or Mitsu 01
Resolution <i>Accuracy <math>\pm 3 \mu\text{m}</math></i> <i>Accuracy <math>\pm 5 \mu\text{m}</math></i>	0.005 $\mu\text{m}$ 0.01 $\mu\text{m}$	0.01 $\mu\text{m}$ 0.05 $\mu\text{m}$	
Calculation time $t_{\text{cal}}$ <i>EnDat 2.1 command set</i> <i>EnDat 2.2 command set</i>	< 1 ms $\leq 5 \mu\text{s}$	– –	
<b>Incremental signals</b>	$\sim 1 V_{\text{PP}}^{1)}$	–	
Grating period/signal period	20 $\mu\text{m}$	–	
Cutoff frequency –3dB	$\geq 150 \text{ kHz}$	–	
<b>Power supply</b> Without load	3.6 to 5.25 V / < 300 mA		
<b>Electrical connection</b>	Separate adapter cable (1 m/3 m/6 m/9 m) connectable on both sides to mounting block		
<b>Cable length</b> <sup>2)</sup>	$\leq 150 \text{ m}$ ; depending on the interface and subsequent electronics	$\leq 30 \text{ m}$	$\leq 20 \text{ m}$
<b>Traversing speed</b>	$\leq 180 \text{ m/min}$		
<b>Required moving force</b>	$\leq 4 \text{ N}$		
<b>Vibration</b> 55 to 2000 Hz <b>Shock</b> 11 ms <b>Acceleration</b>	$\leq 200 \text{ m/s}^2$ (EN 60068-2-6) $\leq 300 \text{ m/s}^2$ (EN 60068-2-27) $\leq 100 \text{ m/s}^2$ in measuring direction		
<b>Operating temperature</b>	0 to 50 °C (as of ML 3240, the storage temperature range is restricted to –10 °C to +50 °C)		
<b>Protection</b> EN 60529	IP 53 when mounted according to the instructions and mounting information IP 64 if compressed air is connected via DA 400		
<b>Weight</b>	0.4 kg + 3.3 kg/m measuring length		

\* Please select when ordering

<sup>1)</sup> Depending on the adapter cable

<sup>2)</sup> With HEIDENHAIN cable

# LC 400 series

- Absolute linear encoders for measuring steps to 0.1 μm (resolution to 0.005 μm)
- For limited installation space
- Up to two additional scanning units are possible

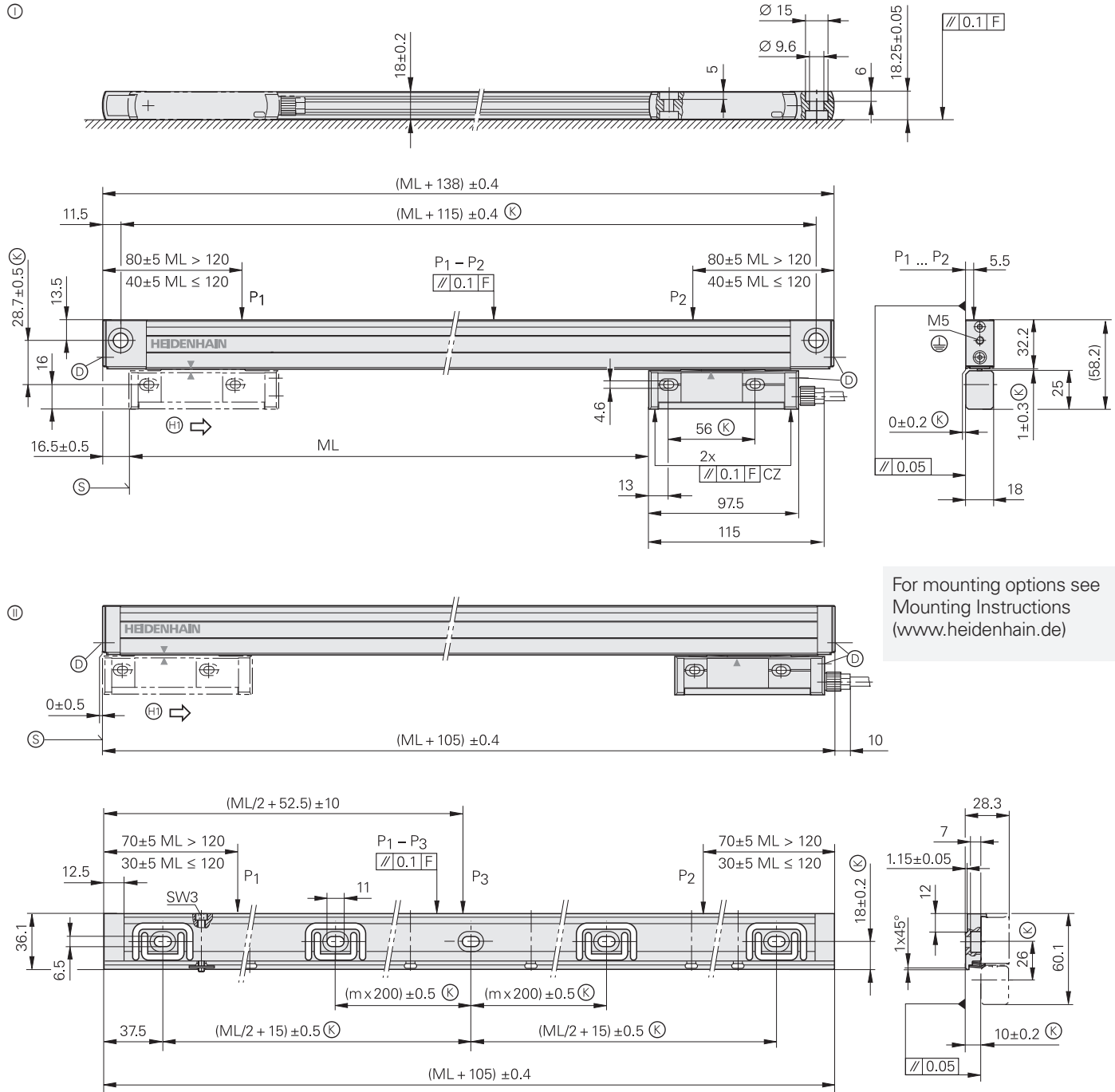

For mounting options see  
Mounting Instructions  
([www.heidenhain.de](http://www.heidenhain.de))

mm  
  
 Tolerancing ISO 8015  
 ISO 2768 - m H  
 < 6 mm: ±0.2 mm

- ⊖ = Without mounting spar (with M8 screws)
- ⊕ = Mounting with mounting spar (LC 483 with short end pieces shown; LC with normal end pieces can also be mounted)
- F = Machine guideway
- P = Gauging points for alignment  
 ML ≤ 820 P<sub>1</sub> - P<sub>2</sub>  
 ML > 820 P<sub>1</sub> - P<sub>3</sub>
- ⊙ = Required mating dimensions
- ⊗ = Compressed air inlet
- ⊙ = Beginning of measuring length (ML) at 20 mm
- ⊕ = Direction of scanning unit motion for output signals in accordance with interface description

### Mounting spar

ML	m
70 ... 520	0
570 ... 920	1
1020 ... 1340	2
1440 ... 1740	3
1840 ... 2040	4

LC 483 without mounting spar



LC 483 with mounting spar

Specifications	LC 483	LC 493F	LC 493M
<b>Measuring standard</b> Coefficient of linear expansion	DIADUR glass scale with absolute track and incremental track $\alpha_{\text{therm}} \approx 8 \times 10^{-6} \text{ K}^{-1}$ (mounting type ①); <i>with mounting spar</i> : $\alpha_{\text{therm}} \approx 9 \times 10^{-6} \text{ K}^{-1}$ (mounting type ②)		
<b>Accuracy grade*</b>	$\pm 3 \mu\text{m}$ ; $\pm 5 \mu\text{m}$		
<b>Measuring length ML*</b> in mm	Mounting spar* or clamping elements* optional 70 120 170 220 270 320 370 420 470 520 570 620 670 720 770 820 870 920 1020 1140 1240  Mounting spar* or clamping elements* required 1340 1440 1540 1640 1740 1840 2040		
<b>Absolute position values*</b>	EnDat 2.2 <i>Ordering designation</i> EnDat 02	Fanuc 02 serial interface	Mitsubishi high speed serial interface, Mit 02-4 or Mitsu 01
Resolution <i>Accuracy <math>\pm 3 \mu\text{m}</math></i> <i>Accuracy <math>\pm 5 \mu\text{m}</math></i>	0.005 $\mu\text{m}$ 0.01 $\mu\text{m}$	0.01 $\mu\text{m}$ 0.05 $\mu\text{m}$	
Calculation time $t_{\text{cal}}$ <i>EnDat 2.1 command set</i> <i>EnDat 2.2 command set</i>	< 1 ms $\leq 5 \mu\text{s}$	– –	
<b>Incremental signals</b>	$\sim 1 \text{ V}_{\text{PP}}^{1)}$	–	
Grating period/signal period	20 $\mu\text{m}$	–	
Cutoff frequency –3dB	$\geq 150 \text{ kHz}$	–	
<b>Power supply</b> Without load	3.6 to 5.25 V/< 300 mA		
<b>Electrical connection</b>	Separate adapter cable (1 m/3 m/6 m/9 m) connectable to mounting block		
<b>Cable length</b> <sup>2)</sup>	$\leq 150 \text{ m}$ ; depending on the interface and subsequent electronics	$\leq 30 \text{ m}$	$\leq 20 \text{ m}$
<b>Traversing speed</b>	$\leq 180 \text{ m/min}$		
<b>Required moving force</b>	$\leq 5 \text{ N}$		
<b>Vibration</b> 55 to 2000 Hz <b>Shock</b> 11 ms <b>Acceleration</b>	<i>Without mounting spar</i> : $\leq 100 \text{ m/s}^2$ (EN 60068-2-6) <i>With mounting spar and cable outlet at right/left</i> : $\leq 200 \text{ m/s}^2/100 \text{ m/s}^2$ (EN 60068-2-6) $\leq 300 \text{ m/s}^2$ (EN 60068-2-27) $\leq 100 \text{ m/s}^2$ in measuring direction		
<b>Operating temperature</b>	0 °C to 50 °C		
<b>Protection</b> EN 60529	IP 53 when mounted according to the instructions and mounting information IP 64 if compressed air is connected via DA 400		
<b>Weight</b>	<i>Encoder</i> : 0.2 kg + 0.5 kg/m measuring length, <i>mounting spar</i> : 0.9 kg/m		





\* Please select when ordering

<sup>1)</sup> Depending on the adapter cable



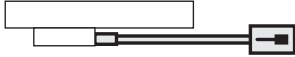

<sup>2)</sup> With HEIDENHAIN cable





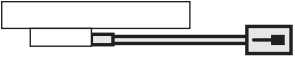
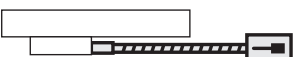

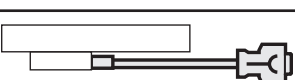
# Electrical connection

## Adapter cables

For absolute linear encoders – EnDat		Cable Ø	LC 183 LC 483 With incremental signals	LC 183 LC 483 Without incremental signals
Adapter cable with M23 coupling (male), 17-pin		6 mm	533631-xx	–
Adapter cable in metal armor with M23 coupling (male), 17-pin		10 mm	558362-xx	–
Adapter cable with D-sub connector, 15-pin		6 mm	558714-xx	–
Adapter cable with M12 coupling (male), 8-pin		4.5 mm	–	533661-xx
Adapter cable in metal armor with M12 coupling (male), 8-pin		10 mm	–	550678-xx

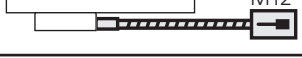
Available cable lengths: 1 m/3 m/6 m/9 m

For absolute linear encoders – Fanuc		Cable Ø	LC 193 F LC 493 F
Adapter cable with M23 coupling (male), 17-pin		4.5 mm	547300-xx
Adapter cable in metal armor with M23 coupling (male), 17-pin		10 mm	555541-xx
Adapter cable with M12 coupling (male), 8-pin		4.5 mm	533661-xx
Adapter cable in metal armor with M12 coupling (male), 8-pin		10 mm	550678-xx
Adapter cable with Fanuc connector, 20-pin		4.5 mm	545547-xx
Adapter cable in metal armor with Fanuc connector, 20-pin		10 mm	551027-xx

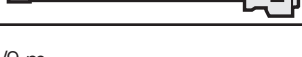
<b>For absolute linear encoders – Mitsubishi</b>		<b>Cable Ø</b>	<b>LC 193M LC 493M</b>
<b>Adapter cable with M23 coupling (male), 17-pin</b>		4.5 mm	547300-xx
<b>Adapter cable in metal armor with M23 coupling (male), 17-pin</b>		10 mm	555541-xx
<b>Adapter cable with M12 coupling (male), 8-pin</b>		4.5 mm	533661-xx
<b>Adapter cable in metal armor with M12 coupling (male), 8-pin</b>		10 mm	550678-xx
<b>Adapter cable with Mitsubishi connector, 10-pin</b>		4.5 mm	640915-xx
<b>Adapter cable with Mitsubishi connector, 20-pin</b>		4.5 mm	599685-xx
<b>Adapter cable in metal armor with Mitsubishi connector, 10-pin</b>		10 mm	640916-xx
<b>Adapter cable in metal armor with Mitsubishi connector, 20-pin</b>		10 mm	599688-xx

Available cable lengths: 1 m/3 m/6 m/9 m





# Electrical connection

## EnDat connecting cables

17-pin  
M23





8-pin  
M12



For EnDat with incremental signals	For EnDat without incremental signals
------------------------------------	---------------------------------------

PUR connecting cables		8-pin: [(4 × 0.14 mm <sup>2</sup> ) + (4 × 0.34 mm <sup>2</sup> )] 17-pin: [(4 × 0.14 mm <sup>2</sup> ) + 4(2 × 0.14 mm <sup>2</sup> ) + (4 × 0.5 mm <sup>2</sup> )]	Ø 6 mm Ø 8 mm
<b>Complete</b> with connector (female) and coupling (male)		323897-xx	368330-xx
<b>Complete</b> with connector (female) and D-sub connector (female) for IK 220		332115-xx	533627-xx
<b>Complete</b> with connector (female) and D-sub connector (male) for IK 115/IK 215		324544-xx	524599-xx
With <b>one</b> connector (female)		309778-xx	559346-xx
<b>Cable without connectors</b> , Ø 8 mm		266306-01	–







# Connecting cables Fanuc Mitsubishi





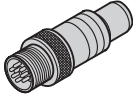

		Cable	Fanuc	Mitsubishi
<b>PUR connecting cable for M23 connecting elements</b>				
<b>Complete</b> with 17-pin M23 connector (female) and Fanuc connector [[2 x 2 x 0.14 mm <sup>2</sup> ) + (4 x 1 mm <sup>2</sup> )]	 Fanuc	Ø 8 mm	534855-xx	–
<b>Complete</b> with 17-pin M23 connector (female) and 20-pin Mitsubishi connector [[2 x 2 x 0.14 mm <sup>2</sup> ) + (4 x 0.5 mm <sup>2</sup> )]	 Mitsubishi 20-pin	Ø 6 mm	–	367958-xx
<b>Complete</b> with 17-pin M23 connector (female) and 10-pin Mitsubishi connector [[2 x 2 x 0.14 mm <sup>2</sup> ) + (4 x 1 mm <sup>2</sup> )]	 Mitsubishi 10-pin	Ø 8 mm	–	573661-xx
<b>Cable only</b> [[2 x 2 x 0.14 mm <sup>2</sup> ) + (4 x 1 mm <sup>2</sup> )]		Ø 8 mm	354608-01	

		Cable	Fanuc	Mitsubishi
<b>PUR connecting cable for M12 connecting elements</b>				
<b>Complete</b> with 8-pin M12 connector (female) and Fanuc connector [[1 x 4 x 0.14 mm <sup>2</sup> ) + (4 x 0.34 mm <sup>2</sup> )]	 Fanuc	Ø 6 mm	646807-xx	–
<b>Complete</b> with 8-pin M12 connector (female) and 20-pin Mitsubishi connector [[1 x 4 x 0.14 mm <sup>2</sup> ) + (4 x 0.34 mm <sup>2</sup> )]	 Mitsubishi 20-pin	Ø 6 mm	–	646806-xx
<b>Complete</b> with 8-pin M12 connector (female) and 10-pin Mitsubishi connector [[1 x 4 x 0.14 mm <sup>2</sup> ) + (4 x 0.34 mm <sup>2</sup> )]	 Mitsubishi 10-pin	Ø 6 mm	–	647314-xx

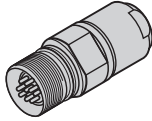
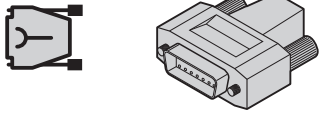
# Pin layout

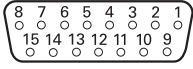
## EnDat

8-pin coupling, M12								
								
	Power supply				Absolute position values			
	<b>8</b>	<b>2</b>	<b>5</b>	<b>1</b>	<b>3</b>	<b>4</b>	<b>7</b>	<b>6</b>
	<b>U<sub>P</sub></b>	<b>Sensor U<sub>P</sub></b>	<b>0V</b>	<b>Sensor 0V</b>	<b>DATA</b>	<b>DATA</b>	<b>CLOCK</b>	<b>CLOCK</b>
	Brown/Green	Blue	White/Green	White	Gray	Pink	Violet	Yellow

17-pin coupling, M23						15-pin D-sub connector For HEIDENHAIN controls and IK 220							
													
													
	Power supply					Incremental signals <sup>1)</sup>				Absolute position values			
	<b>7</b>	<b>1</b>	<b>10</b>	<b>4</b>	<b>11</b>	<b>15</b>	<b>16</b>	<b>12</b>	<b>13</b>	<b>14</b>	<b>17</b>	<b>8</b>	<b>9</b>
	<b>1</b>	<b>9</b>	<b>2</b>	<b>11</b>	<b>13</b>	<b>3</b>	<b>4</b>	<b>6</b>	<b>7</b>	<b>5</b>	<b>8</b>	<b>14</b>	<b>15</b>
	<b>U<sub>P</sub></b>	<b>Sensor U<sub>P</sub></b>	<b>0V</b>	<b>Sensor 0V</b>	<b>Internal shield</b>	<b>A+</b>	<b>A-</b>	<b>B+</b>	<b>B-</b>	<b>DATA</b>	<b>DATA</b>	<b>CLOCK</b>	<b>CLOCK</b>
	Brown/ Green	Blue	White/ Green	White	/	Green/ Black	Yellow/ Black	Blue/ Black	Red/ Black	Gray	Pink	Violet	Yellow







**Cable shield** connected to housing; **U<sub>P</sub>** = Power supply voltage

**Sensor:** The sensor line is connected in the encoder with the corresponding power line.

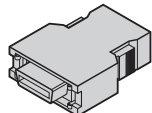
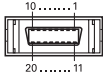
Vacant pins or wires must not be used!

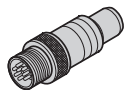
<sup>1)</sup> Only with ordering designations EnDat 01 and EnDat 02









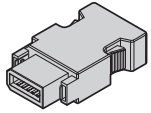

# Fanuc and Mitsubishi

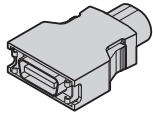
20-pin Fanuc connector					8-pin coupling, M12				
									
	Power supply					Absolute position values			
	9	18/20	12	14	16	1	2	5	6
	8	2	5	1	–	3	4	7	6
	U <sub>P</sub>	Sensor U <sub>P</sub>	0V	Sensor 0V	Shield	Serial Data	Serial Data	Request	Request
	Brown/Green	Blue	White/Green	White	–	Gray	Pink	Violet	Yellow

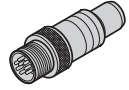
**Cable shield** connected to housing; **U<sub>P</sub>** = power supply voltage

**Sensor:** The sensor line is connected in the encoder with the corresponding power line.

Vacant pins or wires must not be used!

10-pin Mitsubishi connector				20-pin Mitsubishi connector				8-pin coupling, M12						
														
	Power supply					Absolute position values								
	10-pin	1	–	2	–	7	8	3	4					
	20-pin	20	19	1	11	6	16	7	17					
		8	2	5	1	3	4	7	6					
		U <sub>P</sub>	Sensor U <sub>P</sub>	0V	Sensor 0V	Serial Data	Serial Data	Request Frame	Request Frame					
		Brown/Green	Blue	White/Green	White	Gray	Pink	Violet	Yellow					

**Cable shield** connected to housing; **U<sub>P</sub>** = power supply voltage

**Sensor:** The sensor line is connected in the encoder with the corresponding power line.

Vacant pins or wires must not be used!

---

# HEIDENHAIN

**DR. JOHANNES HEIDENHAIN GmbH**

Dr.-Johannes-Heidenhain-Straße 5

**83301 Traunreut, Germany**

☎ +49 8669 31-0

FAX +49 8669 5061

E-mail: [info@heidenhain.de](mailto:info@heidenhain.de)

---

**[www.heidenhain.de](http://www.heidenhain.de)**

**For more information:**

- Catalog: *Linear Encoders for Numerically Controlled Machine Tools*