

MEGA
Electronics



PCB tank production at Mega.



Stores at Mega House.

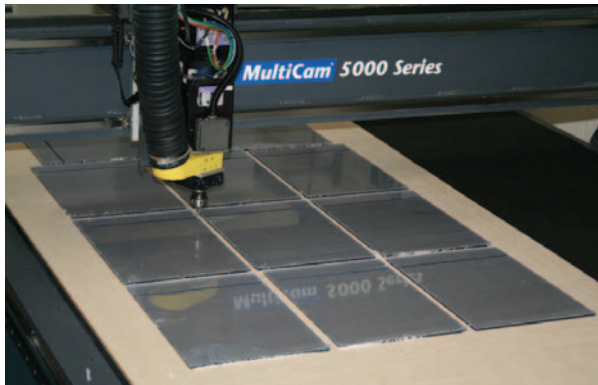

Fabrication of plastics for equipment production on 2m x 3m CNC Machine.

Mega Electronics, the leading European manufacturing company of production equipment for prototype or low volume production quantities of printed circuit boards, front panels, labels and signs.

Mega has been manufacturing PCB production equipment, such as Bubble Etch Tanks and UV Exposure units, since 1977.

To accompany the in-house manufactured items the company distributes a comprehensive range of consumables specifically selected for the engineer and educationalist.

As well as being able to supply everything required for the design and production of PCBs, there are also four systems available for the production of labels, front panels or signs and a system for metal etching of panels.

COMPREHENSIVE PRODUCT RANGE

A complete range of products for the design and manufacture of 'in-house' Printed Circuit Boards, Labels, Front Panels and Signs.

LOW CARRIAGE CHARGES

Carriage charged at cost.

SAME DAY DESPATCH

All orders normally despatched the same day as receipt.

NEXT DAY DELIVERY

A next day delivery to most UK locations, on request, typical cost £6.50 to 25Kg.

ACCOUNT TERMS

All UK schools, colleges and government departments have automatic account facilities. Applications for credit terms are welcome from other organisations or individuals. See inside back cover for further details.

SIMPLE ORDERING

By telephone (please quote your account number), in writing, via www or by fax. Written confirmations are not required. £15 minimum order.



Visit our Website at
www.megauk.com

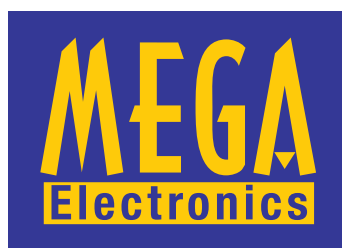

MEGA HOUSE
GRIP INDUSTRIAL ESTATE
LINTON, CAMBRIDGE CB1 6NR

TEL: 01223 893900
FAX: 01223 893894

email: sales@megauk.com

<i>Description</i>	<i>Page</i>	<i>Description</i>	<i>Page</i>	<i>Description</i>	<i>Page</i>
A					
ABC Copper Plating	18	Gedakop	37-39	Plating Line	18
Applicator Pads	39	Gedakop, Consumables	38-39	Plating Powders, tin	32
Applicators, Seno	31	Gedalu	39	Plotting Systems	5
Artwork Aids	2-3	Gedaseal	39	Power Safety Cut-out	47
B					
Bench Line	14	Glass Etching / Engraving	46	Processing Dishes	48
Board Dryer	24	Gloves, Protective	47	PTH Kits	21
Brush Cleaning Machine	24	Guillotine Blades	48	Q	
Bubble Etch Tank	10	Guillotines	25	Quick-Laser	42-43
C					
Canopies	22	H		Quick-Mark	40-41
Carbide Drill Bits & Routers	30	High Speed Drilling Machines	26-27	Quikmask Glass Etching	46
CNC Production Centre	28-29	I			
Chemistry PCB	31-33	Immerse Tin Plating	32	R	
Chip Breaker Routers	30	Ink Jet Artwork Film, JetStar	3	Raster Photoplotter	5
Colour Dyes, Gedakop	38	Ink Mixing Cup	36	Resist Stripper	33
Colour Swatch, Gedakop	38	Inks, Screen Printing	35	Roller Tinning Machines	24
Conveyorised Processors	17	Ionex Water Treatment	19	Rota-Spray Base Unit	15
Corner Rounder	26	J			
Coveralls	47	JET 34D Spray Processor	14	Rota-Spray Processor	15
D					
Dalo Etch Resist Pens	2	JetStar Artwork Film	3	Router bits	30
Developer Pads, HB104	39	L			
Developers, Photoresist	31	Label Production	40-43	Routing Machine	27
Disposable Gloves	47	Laboratory Coat	47	S	
Double Sided Adhesive Sheets	39	Laboratory Ovens	20	Safety Products	47
Double Sided UV Units	9	Labstations, PCB	13	Sand Blasting	46
Drafting Film	3	Laminators, Dry Film	23	Screen Printing	34
Drill Bits	30	Laser Labels	42-43	Scrub Block	33
Drill Collars	30	LaserStar Artwork Film	3	Sealing Consumables	39
Drill entry / Exit Board	6 & 28	Light Boxes	4	Sealing Tanks	39
Drill Stand	26	M			
Drilling Machines	26-27	Metal Cleaner	33	Seno Applicators	31
Drilling Station	26	Metal Etching Kit	45	Shears	25
Dry Film Laminators	23	Microtrak	7	Signing Systems	38-45
Dry Film Photoresist	23	Microtrak Chemistry	33	Solder Resist Ink	35
Dry Film Soldermask Roll	23	Mino Ovens	20	Solvent Universal	33
Drying Machine, PCB	24	Multilayer Press	20	Spares	48
Dyes, Gedakop	38	N			
E					
Economy PCB Laminates	7	Negative Artwork Film	3	T	
Etch Resist Inks, Screen Printing	35	O			
Etch Resist Pen	2	Ovens	20	Tanks, PCB Processing	10-11
Etch Resist Transfers	2	P			
Etchants	32	Palette Knife	36	Thermostat, Tank	48
Exposure Units, UV	8-9	PCB Board Dryer	24	Through Hole Plating, chemical	18
Extraction Canopies	22	PCB Chemicals	31-33	Through Hole Plating, mechanical	19
Extraction Systems	22	PCB Copper Clad Board	6-7	Tin Plating Solutions	32
Eye Protection Products	47	PCB Drilling Machines	26-27	Touch-Up Pens	2
F					
Favorit Through Hole Plating	19	PCB Kits	12	Transfers	2
Ferric Chloride Pellets	32	PCB Labstations	13	Trays	48
Ferric Chloride Solution	32	PCB Laminates	6	U	
Ferric Chloride Stain Remover	33	PCB Processing Tanks	10-11	Uncoated PCB Laminates	6
Fine Etch Crystals	32	PCB Production Lines	14	Universal PCB Holder	48
Five Star Film	34	PCB Starter Kits	12	Universal Processing Tank	11
Fotoboard	6	Peeling Boards	41	Universal Solvent	33
Front Panel Production	37-41	Photoimagable Inks	35	UV Exposure Units	8-9
Fume Extraction	22	Photoplotter	5	UV Exposure Units (spares)	48
G					
H					
I					
J					
K					
L					
M					
N					
O					
P					
Q					
R					
S					
T					
U					
V					
W					
X					
Y					
Z					

ARTWORK AIDS

A range of the highest quality etch resist transfers for preparing PCB layouts. Circuits are prepared by rubbing down the transfers onto drafting film. The etch resist nature of the transfers means they may also be rubbed down directly onto copper clad boards. Sheet size 255 x 90mm.

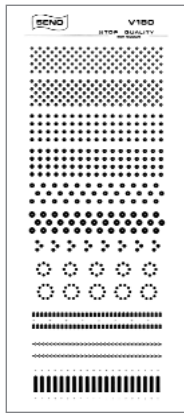

V180

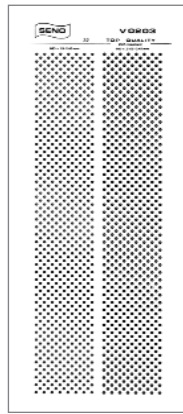

V0203

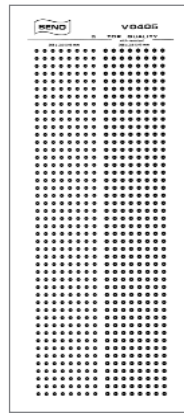

V0405

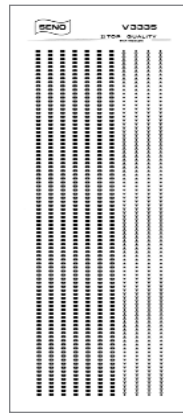

V3335

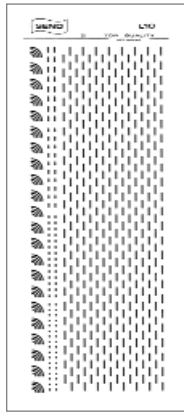

L10

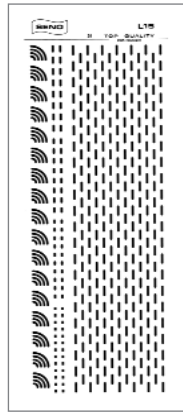

L15

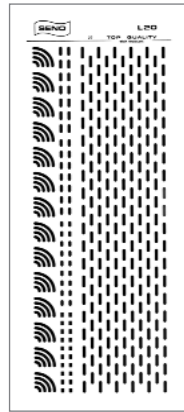

L20

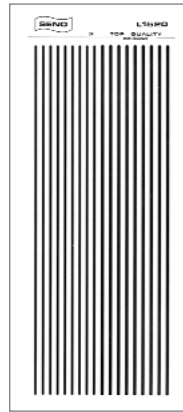

L1520

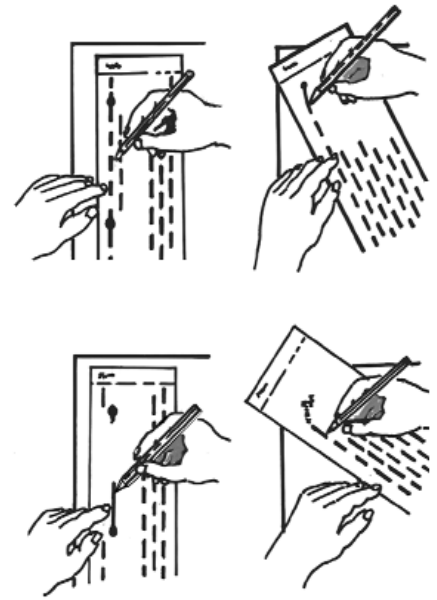

Diagrams above:

The easy method to add unbroken tracks and curves using the L05, L10, L15 and L20 transfers.

Order Code		Price 1+	Price 10+
100-001	V180 Assorted Pads	£2.20	£1.90
100-002	V0203 Round Pads 1.9/0.45mm, 2.1/0.45mm	£2.20	£1.90
100-003	V0405 Round Pads 2.5/0.45mm, 2.8/0.45mm	£2.20	£1.90
100-004	V3335 DIL Pads	£2.20	£1.90
100-005	L0510 Straight Tracks 0.5/1.0mm (not shown)	£2.20	£1.90
100-006	L1520 Straight Tracks 1.5/2.0mm	£2.20	£1.90
100-007	L05 Tracks and Curves 0.5mm (not shown)	£2.20	£1.90
100-008	L10 Tracks and Curves 1.0mm	£2.20	£1.90
100-009	L15 Tracks and Curves 1.5mm	£2.20	£1.90
100-010	L20 Tracks and Curves 2.0mm	£2.20	£1.90

Artwork
Touch-Up and
Etch Resist Pens

Touch-Up Pens

Three high quality artwork touch-up pens containing UV opaque ink.



RA613 - Fine Nib
RA614 - Medium Nib
RA615 - Ult. Fine Nib

Order Code		Price 1+	Price 10+
100-032	RA613 Fine Nib 1mm	£6.95	£6.25
100-033	RA614 Med. Nib 3mm	£8.05	£7.25
100-031	RA615 Ult. Fine Nib 0.5mm	£6.95	£6.25

Dalo Etch Resist Pen (PC 33)

A superior quality etch resist pen offering a high degree of resistance to etchants.



Order Code		Price 1+	Price 10+
100-052	Dalo Etch Resist Pen	£2.40	£2.20

Economy Etch Resist Pen

A pen containing etch resist ink for marking directly onto copper clad boards.

Order Code		Price 1+	Price 10+
100-034	Etch Resist Pen	£0.95	£0.90

LaserStar

A specially formulated translucent film for the production of high resolution PCB artworks directly from any Laser printer. LaserStar has a 75 micron base with a special coating for high resolution keying and fixing of toner enabling crisp dense artworks to be produced. The film will also accept copier toner enabling usable artworks to be produced from pre-printed originals.

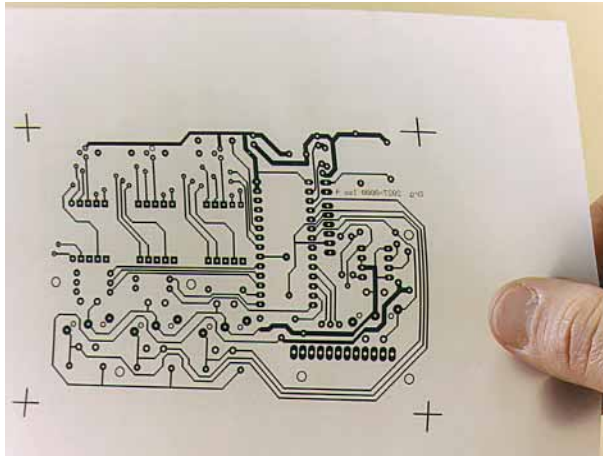

Order Code		Price
100-062	LaserStar A 4 sheets pack of 10	£5.10
100-063	LaserStar A 4 sheets pack of 100	£45.50
100-065	LaserStar A 3 sheets pack of 10	£10.15
100-064	LaserStar A 3 sheets pack of 100	£91.85

Negative Film

Orange Dry Peel Negative Film



A UV opaque orange artwork reversal film. After exposure the film is applied to the adhesive peeling board which must be purchased separately. The board has a low tack adhesive on the surface which aids separation during the peeling process. The top layer of the film which is peeled away will be an exact reversal of the original artwork. The orange emulsion is UV opaque.

Order Code		Price
	Neg. to Pos.	
800-310	10" x 12" (10)	£25.50
800-320	12" x 20" (5)	£25.50
800-301	Peeling Board 10" x 12"	£8.50
800-300	Peeling Board 12" x 20"	£12.25

JetStar Inkjet Film

Inkjet Film for artwork production

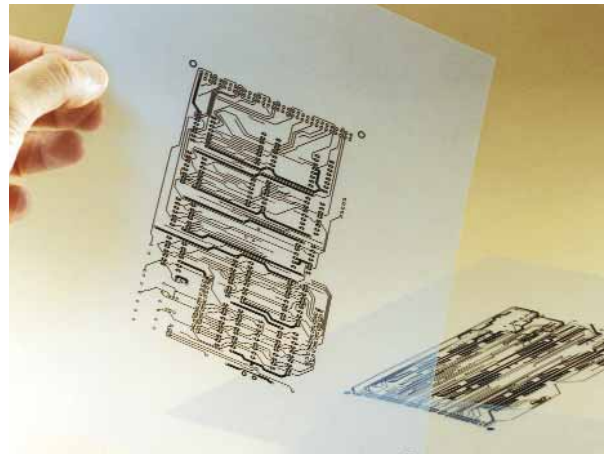

JetStar Standard

A specially formulated, inkjet film for the production of artwork photo tools for graphics and PCB production. The coating on the film allows dense image to be produced without the ink bleeding. The film is designed for use with ink jet printers using dye-based ink. Pigments based inks, used for long lasting digital photograph prints, may not be suitable for JetStar. Available in A4 size in 10 or 100 sheet packs.

Order Code		Price
100-070	JetStar A4 (10 Sheets)	£5.10
100-071	JetStar A4 (100 Sheets)	£45.50
100-072	JetStar A3 (10 Sheets)	£10.15
100-073	JetStar A3 (100 Sheets)	£91.85

JetStar Premium

Featuring a superior coating to JetStar Standard this inkjet film should be used for the ultimate quality artwork production for graphics and PCB production. The extra fast drying coating on the film allows extremely dense, high resolution images to be printed. This film is designed for use with ink jet printers using either dye-based or modern pigment based inks. Available in A4 size in 10 or 100 sheet packs.

Order Code		Price
100-075	JetStar Premium A4 (10 Sheets)	£10.50
100-076	JetStar Premium A4 (100 Sheets)	£102.40
100-077	JetStar Premium A3 (10 Sheets)	£20.50
100-078	JetStar Premium A3 (100 Sheets)	£202.00

Artwork Drafting Film

Packs of ten sheets of matt .003" polyester drafting film which will stand up to constant handling.

Order Code		Pack Price
100-027	A4	£3.95
100-053	A3	£7.85

UV Filter Film

Polyester film coated with a yellow ultra violet light filter. Suitable for masking windows etc. Supplied in full rolls 10 metres x 59" wide or by the running metre.

Order Code		Price
06-14062	59" x 10M roll	£245.00
06-14061	59" per metre	£26.00

ARTWORK AIDS

Film Products

Films for positive and negative artwork production.

LIGHT BOXES

High Quality Light Boxes to aid artwork production.

Artwork Light Boxes - an invaluable aid to any artwork preparation



Two Artwork Light Boxes, nominally 12" square and 18" x 24", manufactured from white steel with flush fitting opal Perspex lid. The larger unit has an exact illuminated working area of 458mm x 610mm and the smaller 300mm x 300mm. Both have a front mounted on/off rocker switch fitted and are fitted with non slip rubber feet. Power is introduced via a fitted IEC and supplied 2m mains lead with moulded 13 amp plug.

Viewing Area	Perspex	Tubes	Weight (approx)
300 x 300mm	5mm	2 x 8w 12"	4kg
458 x 610mm	5mm	2 x 20w 24"	8kg

Order Code		Price
200-020	Small Artwork Light Box 300mm x 300mm	£105.00
200-021	Large Artwork Light Box 458mm x 610mm	£225.00

High Quality A3 Artwork Light box Model LB410

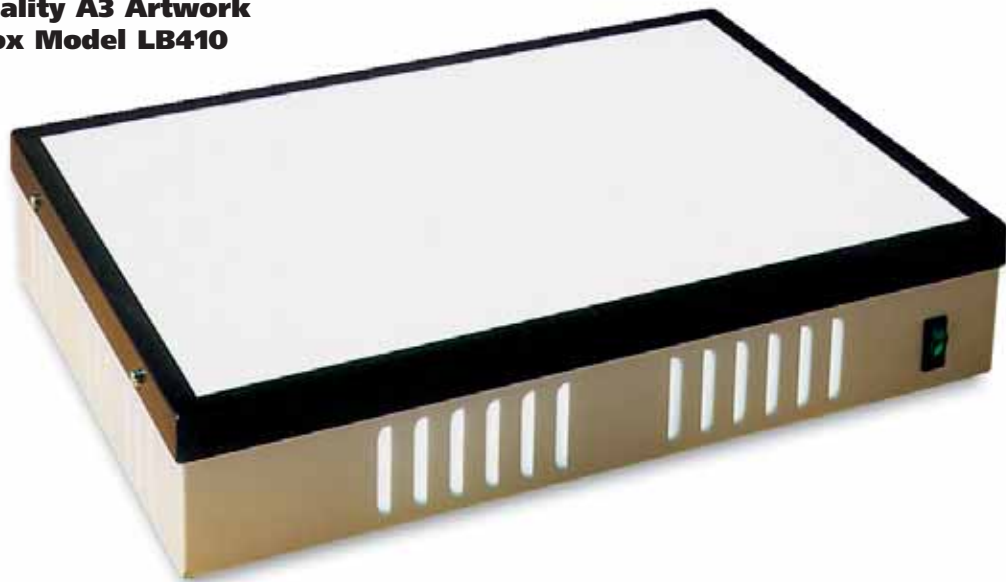

A high quality case is constructed from 18 gauge steel featuring air vents in four sides and is completed using sheets of 050 opal Perspex and glass which is secured by a black lid surround. This ensures both even temperature and illumination. The glass top means that a scalpel may be used to trim artworks directly on the illuminated surface. The A3 nominal size is achieved with a viewing area of 304mm x 454mm. A combined neon indicator ON /OFF switch is front mounted and all are supplied with fused IEC socket, 2 metres of mains lead and moulded 13 Amp plug. Please enquire as to the availability of other sizes.

Viewing Area	Perspex	Glass	Tubes	Weight (approx)
304 x 454mm	3mm	3mm	2 x 15W x 18"	6.6kg

Order Code		Price
200-002	Light Box LB410 Plain A3	£170.00

Raster photoplotter



The FP8000 (8000 dpi) Raster photoplotter is a highly accurate machine for creating dense phototools. The machine draws the image on a piece of light sensitive film with a laser. The film is attached to the outer surface of a rotating drum and the laser moves step by step along the rotating drum. A supplied external universal power unit is used to supply required power (110-240V/24V). The photoplotter software allows you to read input files and to set output resolution and type of image (reverse, mirror, etc.) drawn on the film. When working with Gerber files, it is possible to check and modify used apertures (D-codes) and make simple film panelization for Gerber data and corresponding drill data. Viewing of Gerber files and conversion of various types of aperture files is possible in freeware program ViewMate (made by Pentalogix).

Photoplotter software is supplied on CD or one diskette with installation program. Requires Pentium computer with USB port and Windows 95-98 or higher, 100 MB HD space minimum for software and output files. The computer speed has influence on plotting time. Various types of films may be used for this photoplotter, but all of them must be sensitive to light wave length of 670 nm (red light). A suitable film and chemistry is offered below. Full darkroom conditions are needed to load and process the film. A green safe light fluorescent bulb is available for use in a darkroom in three different lengths.

Technical Specifications

Maximum film size:	370 × 340 mm (width × height)
Maximum photoplotting area:	370 × 320 mm
Plot resolution:	508 × 8000 dpi, 1016 × 8000 dpi, 1355 × 8000 dpi, 1625 × 8000 dpi, 2032 × 8000 dpi, 2710 × 8000 dpi, 4064 × 8000 dpi, 8192 × 8000 dpi
Plotting speed:	13 mm of film width/minute for 1016 dpi
Source of light:	Laser diode 670 nm (red)
Reads in:	Gerber (RS 274D, RS 274X), BMP, Postscript (option)
Photoplotter overall size:	700 (length) × 370 (width) × 230 (height) mm
Photoplotter weight approx:	28 kg (56 lbs)
Power:	An external power supply unit (110V-240V/24V)

Order Code		Price
57-61605	Raster Photoplotter FP8000 (USB)	£3795.00
57-61615-1	Postscript option for 57-61605	£575.00
57-61716	Photoplot Film 310 × 380mm 50 sheet pack	£95.00
57-61711	Photoplot Film 310mm × 60M	£249.00
57-61706	Developer for Photoplot (5 ltr)	£18.50
57-61707	Fixer for Photoplot (5 ltr)	£20.50
45-3807	305mm × 410mm Processing dish	£11.50
57-61625	Green Safe Light 600mm 18W	£44.00
57-61626	Green Safe Light 900mm 30W	£55.50
57-61627	Green Safe Light 1200mm 36W	£58.80

PLOTTING SYSTEMS

Photoplot
Imaging System

Plots to
320 × 370 mm

Accurate
Phototools

Conventional
Laser
Photoplotter

PCB LAMINATES

Uncoated laminates and 'Pre-sensitised' laminates coated with a Positive working resist.

Fotoboard Pre-sensitised 'FR4' Copper Board

The first choice for the production of quality printed circuit boards.

Fotoboard is a positive working, Photoresist coated, glass fibre printed circuit laminate to BS4584 and MILSPEC MIL-P-13949GE GRN. The resist is applied 5 microns thick using a specially developed roller coating process which ensures a particularly even layer. The resist is high temperature cured which, combined with its tough plastic film laminate covering, results in a durable board which can be handled, guillotined and processed with a high degree of safety. Inspection at the development stage is simplified by use of a green dye in the Photoresist. Fotoboard is 1/16" thick, 1 oz copper. It has a minimum shelf life of one year and is available as both single and double sided. 2 oz and other thickness' are available on request.

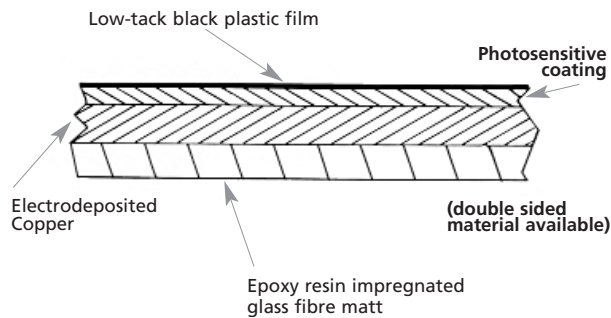

Thickness	1/16" (1.6mm)
Copper per square foot	1oz (35 microns)
Water Absorption	0.12%
Dielectric Constant (1 MHz)	4.55
Dissipation Factor	0.0175
Flexural strength, Lengthways (N/mm ²)	530.00
Flexural strength, Crosswise (N/mm ²)	425.50
Peel Strength (N/mm ²)	1.95

Order Code		Price (Each Sheet)			
		1+	5+	10+	25+
Single Sided					
400-002-1	4" x 6"	£1.95	£1.75	£1.60	£1.40
400-007-1	6" x 12"	£5.60	£5.15	£4.65	£4.20
400-009-1	9" x 12"	£8.40	£7.70	£7.00	£6.30
400-010-1	10" x 12"	£10.75	£9.85	£9.00	£8.10
400-011-1	12" x 12"	£11.00	£10.10	£9.15	£8.25
400-012-1	12" x 18"	£15.20	£13.95	£12.70	£11.60
400-013-1	12" x 24"	£20.70	£19.00	£17.25	£15.55
400-014-1	18" x 24"	£30.00	£27.70	£25.50	£22.50
Double Sided					
400-016-1	4" x 6"	£2.15	£2.00	£1.80	£1.60
400-021-1	6" x 12"	£6.20	£5.65	£5.20	£4.65
400-023-1	9" x 12"	£9.35	£8.55	£7.85	£7.05
400-024-1	10" x 12"	£11.80	£10.85	£9.90	£8.90
400-025-1	12" x 12"	£12.30	£11.25	£10.25	£9.20
400-026-1	12" x 18"	£17.80	£16.80	£15.50	£13.75
400-027-1	12" x 24"	£23.30	£21.35	£19.40	£17.45
400-028-1	18" x 24"	£35.00	£32.00	£29.00	£26.50

Order Code		Price (Each Sheet)			
		1+	5+	10+	25+
Single Sided					
400-029-11	100 x 160mm	£2.25	£2.05	£1.90	£1.80
400-030-1	203 x 114mm	£3.10	£2.85	£2.65	£2.50
400-031-1	220 x 100mm	£3.05	£2.80	£2.60	£2.45
400-032-1	233.4 x 220mm	£6.70	£6.10	£5.65	£4.90
400-033-1	233.4 x 160mm	£4.85	£4.45	£4.10	£3.45
Double Sided					
400-034-1	100 x 160mm	£2.65	£2.45	£2.20	£2.00
400-035-1	203 x 114mm	£3.35	£3.10	£2.85	£2.60
400-036-1	220 x 100mm	£3.65	£3.40	£3.05	£2.80
400-037-1	233.4 x 220mm	£7.70	£7.10	£6.45	£5.80
400-038-1	233.4 x 160mm	£5.30	£4.85	£4.45	£4.00

Fotoboard, 0.8mm, 1.0mm 35 and 70 micron copper

Order Code	12" x 18" Sheets	Price Each	
		1+	5+
400-236	1oz (35 Micron) 0.8mm Single Sided	£17.95	£17.05
400-221	1oz (35 Micron) 0.8mm Double Sided	£20.15	£19.15
400-237	1oz (35 Micron) 1.0mm Single Sided	£20.15	£19.15
400-273	1oz (35 Micron) 1.0mm Double Sided	£22.20	£21.10
400-223	2oz (70 Micron) 1.6mm Single Sided	£20.15	£19.15
400-233-1	2oz (70 Micron) 1.6mm Double Sided	£22.80	£21.65

Order Code	18" x 24" Sheets	Price Each	
		1+	5+
400-235	1oz (35 Micron) 0.8mm Single Sided	£35.20	£33.45
400-253	1oz (35 Micron) 0.8mm Double Sided	£39.20	£37.25
400-246	1oz (35 Micron) 1.0mm Single Sided	£39.20	£37.25
400-254	1oz (35 Micron) 1.0mm Double Sided	£43.45	£41.30
400-252	2oz (70 Micron) 1.6mm Single Sided	£39.20	£37.25
400-272	2oz (70 Micron) 1.6mm Double Sided	£44.50	£42.30

Flexible Polyester Laminate

A flexible laminate made from a 50µ polyester base with a 35µ copper coating and our photosensitive resist on one side. This laminate is ideal for prototyping. It is supplied in a light proof sealed bag and is not covered in a protective film.

Order Code		Price
400-105	Resist Coated Flex. Polyester Single Sided 305 x 500mm per sheet	£18.45

Uncoated PCB Laminates

A selection of the same high quality FR4 laminate used for our other laminates without a Photoresist coating. It is ideal for use with dip coating machines, dry film laminators, screen printed resists and direct imaging via etch resist transfer or ink pen. All sizes are supplied as single sheets.

Order Code		Price (Each Sheet)			
		1+	5+	10+	25+
Single Sided					
16-21003	48" x 36"	£46.75	£45.15	£43.60	£41.50
16-21016	24" x 18"	£13.10	£12.60	£12.30	£11.80
16-21018	18" x 12"	£6.85	£6.60	£6.35	£6.15
Double Sided					
16-21004	48" x 36"	£47.80	£46.50	£44.60	£43.00
16-21017	24" x 18"	£13.55	£13.10	£12.60	£12.10
16-21019	18" x 12"	£7.10	£6.85	£6.60	£6.40

Drill Entry/Exit Board 12" x 18"

High quality drill entry and exit boards for precision drilling with a CNC drilling machine (see pages 28 and 29).

Order Code		Price (Each Sheet)			
		1+	5+	10+	25+
400-265	0.8 mm entry	£0.75	£0.70	£0.68	£0.65
400-266	1.5 mm exit	£1.35	£1.28	£1.20	£1.10

FPC 16 Pre-sensitised Economy Board

A fibre glass and paper composite laminate manufactured to the same high quality standards as Fotoboard but giving certain price and weight advantages. FPC-16 consists of two fibre glass outer layers with a paper composite in between. The 1 oz copper thickness and high quality Photoresist are the same as Fotoboard. The construction of FPC-16 makes it light, easy to cut and drill. It also costs less to manufacture making it cheaper than Fotoboard. Various single and double sided options are available all supplied as single sheets.

Order Code		Price (Each Sheet)			
		1+	5+	10+	25+
Single Sided					
400-040-1	4" x 6"	£1.50	£1.35	£1.25	£1.10
400-045-1	6" x 12"	£4.20	£3.85	£3.45	£3.15
400-047-1	9" x 12"	£6.25	£5.75	£5.25	£4.75
400-048-1	10" x 12"	£8.20	£7.50	£6.80	£6.15
400-049-1	12" x 12"	£8.25	£7.55	£6.85	£6.20
400-050-1	12" x 18"	£11.80	£10.85	£9.85	£8.85
400-051-1	12" x 24"	£15.55	£14.25	£12.95	£11.65
400-052-1	18" x 24"	£23.10	£21.20	£19.25	£17.35
Double Sided					
400-054-1	4" x 6"	£1.80	£1.65	£1.50	£1.40
400-059-1	6" x 12"	£5.10	£4.65	£4.20	£3.80
400-061-1	9" x 12"	£7.65	£7.05	£6.35	£5.80
400-062-1	10" x 12"	£9.95	£9.15	£8.35	£7.50
400-063-1	12" x 12"	£10.05	£9.25	£8.40	£7.55
400-064-1	12" x 18"	£14.50	£13.30	£12.10	£10.85
400-065-1	12" x 24"	£18.95	£17.40	£15.80	£14.25
400-066-1	18" x 24"	£28.40	£26.00	£23.70	£21.35

Order Code		Price (Each Sheet)			
		1+	5+	10+	25+
Single Sided					
400-067-1	100 x 160mm	£1.70	£1.56	£1.45	£1.35
400-068-1	203 x 114mm	£2.15	£1.98	£1.85	£1.70
400-069-1	220 x 100mm	£2.10	£2.00	£1.80	£1.65
400-070-1	233.4 x 220mm	£4.80	£4.40	£4.00	£3.60
400-071-1	233.4 x 160mm	£4.00	£3.65	£3.35	£3.00
Double Sided					
400-072-1	100 x 160mm	£2.10	£1.93	£1.80	£1.65
400-073-1	203 x 114mm	£2.60	£2.51	£2.30	£2.05
400-074-1	220 x 100mm	£2.50	£2.36	£2.15	£1.95
400-075-1	233.4 x 220mm	£5.80	£5.35	£4.85	£4.40
400-076-1	233.4 x 160mm	£4.85	£4.45	£4.05	£3.65

Microtrak Resist Coated Laminates

Microtrak laminates were previously supplied by Instagraphics Products Ltd.

The FR4 epoxy glass laminate is dip coated with a high resolution positive working Photoresist. The Photoresist contains a dye which gives a good contrast against the copper, allowing boards to be easily inspected at the developing stage. Panels are protected by a specially designed light-proof blue film which allows panels to be guillotined without the risk of fracturing the Photoresist. Microtrak processing chemistry can be found on page 33.

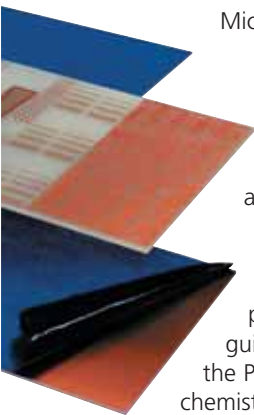

Specifications

Thickness:	1.6mm or 0.8mm
Copper foil:	35 micron or 70 micron
Dielectric Breakdown:	Spec. 40kV Typical Value 60Kv
Permittivity:	Spec. 5.4 @ 1MHz Typical Value 4.8 @ 1MHz Typical Value 4.5 @ 1GHz
Solderbath resistance:	(260°C) 20 secs
Resist thickness:	5 microns
Spectral response:	350-450nm
Shelf life:	1 year at 15-20°C
Developer:	CPD5
Etchant:	Ferric Chloride Pellets or liquid and Fine Etch Crystals

Sizes available:

510 x 1150mm (20" x 45.2")
 575 x 510mm (22.6" x 20.1")
 233.4" x 160mm (9.2" x 6.3")
 100 x 160mm (3.9" x 6.3")
 457 x 305mm (18" x 12")
 305 x 254mm (12" x 10")
 305 x 203mm (12" x 8")
 254 x 203mm (10" x 8")

Ordering Information			Copper 1 Side 35 Micron			
Thickness mm	Panel Size mm	Part No.	Price (Each Sheet)			
			1+	5+	10+	25+
1.6	510 x 1150	03-5185	£55.75	£51.33	£46.85	£41.80
1.6	575 x 510	03-5141-1	£27.40	£25.20	£23.00	£20.55
1.6	233.4 x 160	03-5144-1	£4.85	£4.45	£4.05	£3.65
1.6	100 x 160	03-5108-1	£2.20	£2.02	£1.85	£1.70
1.6	457 x 305	03-5142	£15.20	£13.95	£12.70	£11.40
1.6	305 x 254	03-5103-1	£10.76	£9.90	£9.05	£8.05
1.6	305 x 203	03-5104-1	£9.45	£8.69	£7.95	£7.10
1.6	254 x 203	03-5105-1	£6.75	£6.20	£5.65	£5.05
0.8	510 x 1150	03-5183	£51.15	£47.00	£43.00	£38.35

Ordering Information			Copper 1 Side 70 Micron			
Thickness mm	Panel Size mm	Part No.	Price (Each Sheet)			
			1+	5+	10+	25+
1.6	510 x 1150	03-5187	£66.00	£60.70	£55.45	£49.50

Ordering Information			Copper 2 Sides 35 Micron			
Thickness mm	Panel Size mm	Part No.	Price (Each Sheet)			
			1+	5+	10+	25+
1.6	510 x 1150	03-5186	£63.10	£58.00	£53.00	£47.30
1.6	575 x 510	03-5150-1	£32.50	£29.90	£27.30	£24.40
1.6	233.4 x 160	03-5153-1	£5.25	£4.85	£4.40	£3.95
1.6	100 x 160	03-5128-1	£2.60	£2.40	£2.10	£1.95
1.6	457 x 305	03-5151	£17.80	£16.40	£14.95	£13.35
1.6	305 x 254	03-5123-1	£11.80	£10.86	£9.90	£8.85
1.6	305 x 203	03-5124-1	£8.95	£8.25	£7.50	£6.70
1.6	254 x 203	03-5125-1	£7.45	£6.85	£6.25	£5.60
0.8	510 x 1150	03-5184	£59.65	£54.90	£50.10	£44.75

Ordering Information			Copper 2 Sides 70 Micron			
Thickness mm	Panel Size mm	Part No.	Price (Each Sheet)			
			1+	5+	10+	25+
1.6	510 x 1150	03-5188	£78.45	£72.15	£65.90	£58.85

PCB LAMINATES

Positive working 'Pre-sensitised laminates.

Economy Board

Microtrak Board

For processing chemistry see pages 31 - 33.

UV EXPOSURE UNITS

Low Cost 'LV' UV Units

Low Cost UV Units

The steel cased LV models are the most cost effective UV units offered. The tubes are in the base which means the artwork has to be registered on the UV sensitive area and then placed face down onto the exposure area. Coloured black, each unit has a hinged lid containing a pressure pad which, when the lid is held closed by the two retaining clips, acts to force the artwork and sensitive material firmly together on the UV illuminated area. All controls are conveniently front mounted. The LV202-E has a six minute mechanical timer which also acts as the mains switch. When the control knob is rotated to the required time the power is turned on and the exposure commences. The timer clicks off as soon as the exposure is completed. The LV204 controls consist of a 0-500 second digital timer that is set with touch keys. The set time counts down during exposure and then flashes to indicate the exposure is complete. Both UVs come complete with IEC socket and moulded 13 amp plug.



Model	Working Area	Timer	UV Output	Dimensions	Weight
LV202-E	9 x 6.25" 229 x 159 mm	6 mins.	2 x 8W	420 x 175 x 90mm	4.0 KG
LV204	14 x 10.25" 356 x 260 mm	0-500 secs.	4 x 15W	515 x 400 x 120mm	14.0 KG

Order Code		Price 1+	Price 3+	Price 5+
300-001	LV202-E (229 x 159mm)	£99.00	£84.00	£79.90
300-002	LV204 (330 x 260mm)	£210.00	£185.00	£175.75

PLUVEX 1410

Pressure Line UV Exposure unit PLUVEX 1410

The new Pluvex 1410 UV is a high quality pressure contact UV exposure unit featuring UV tubes in the lid to aid artwork registration. To perform an exposure, the artwork and UV sensitive material being exposed are placed on the precision exposure foam pressure pad (fig1). The separate hinged frame containing 4mm glass is then lowered onto this foam pad. It hinges from the rear of the unit and induces a progressive contact line across the face of the foam pad aiding the expulsion of air between the artwork and UV sensitive material (fig 2). The frame is secured with the two front mounting catches to achieve the necessary pressure for the required artwork contact. When the frame is secured the final position and registration of the artwork is checked (fig 3) before lowering the exposure head and commencing the exposure (fig 4). Exposure is controlled by a 0-500 second digital timer that is set via touch keys. The set time counts down during exposure and flashes to indicate the exposure is complete. The tubes in the exposure head are screened with a special membrane which protects the operative from the potential hazards of live electrical parts. The foam exposure pad sits in a tray and can be easily removed for cleaning or quick installation of exposure trays for non-contact curing. The Pluvex is supplied with an IEC socket and moulded 13 amp socket.



1. Artwork and material are placed on foam pad.



2. Hinged pressure frame is lowered and fastened.



3. Position of artwork is checked.



4. Exposure lid is lowered and exposure commenced.

Model	Foam Pad Exposure Area	Timer	UV Output	Dimensions	Weight
PLUVEX 1410	355 x 254mm, 14" x 10"	0-500 secs	4 x 15W	500 x 440 x 150mm	11.5 KG

Order Code		Price 1+	Price 3+	Price 5+
300-250	PLUVEX 1410	£345.00	£325.00	£310.00

Vacuum UV Units

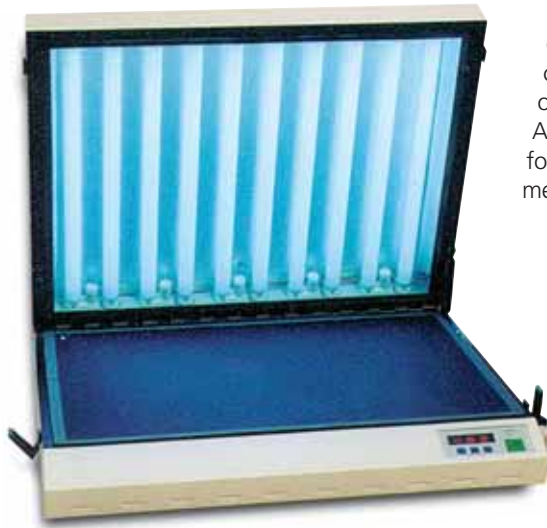

For the ultimate in reproduction definition, a vacuum unit has to be the choice. Unlike the pressure pad units the AY series use a vacuum to ensure the artwork and material to be exposed are held in perfect contact. When fine tracks are required on a PCB or detailed definition on a graphic reproduction, an AY vacuum unit should be chosen. All the AY units now feature the latest rubber blanket and glass vacuum system for the ultimate exposure resolution. The time is then set via the touch membrane control panel and the start button pressed. This activates the

integral vacuum pump which removes the air from the chamber ensuring perfect contact between artwork and material to be exposed. Only when a vacuum has been achieved will the tubes activate and the exposure

commence. When completed the vacuum pump is turned off and a valve automatically releases the vacuum allowing the lid to be raised. All units come complete with an IEC socket and moulded 13 amp plug.

Model	Working Area*	Timer	UV Output	Dimensions	Weight
AY315	13" x 14" (330 x 355mm)	0 - 999 Seconds	6 x 15W	550 x 485 x 170mm	16.0 kg
AY321	13.8" x 21" (350 x 535mm)	0 - 999 Seconds	6 x 20W	720 x 580 x 170mm	22.0 kg
AY360	22.6" x 26.8" (575 x 680mm)	0 - 999 Seconds	10 x 20W	765 x 730 x 178mm	34.0 kg
†AY380	20.4" x 36.5" (520 x 927mm)	0 - 999 Seconds	12 x 20W	890 x 1031 x 215mm	90.0 kg

* vacuum pipe is 25mm diagonally in from top left corner of the exposure area. † AY380 uses 'mylar' to create a vacuum - not rubber and glass.

Order Code		Price 1+	Price 3+	Price 5+
300-100	AY315	£610.00	£580.00	£550.00
300-145	AY321	£685.00	£650.00	£615.00
300-165	AY360	£915.00	£870.00	£825.00
300-046	AY380	£1800.00	£1710.00	£1620.00

AZ Double Sided Vacuum UV Units

A double sided vacuum UV is an essential tool for the production of double sided PCBs. The ability to expose both sides of the board at once eliminates the immense problem of artwork registration for two separate exposures on a single sided unit. The AZ units are similar to the AY range except that they have flexible mylar film in front of the tubes in the lid which closes onto a glass base beneath which is located another set of UV tubes. The units feature a switch to enable the bottom set of tubes to be turned off for single sided exposures. All three units are supplied complete with an IEC socket and moulded 13 amp plug.



Model	Working Area*	Timer	UV Output	Dimensions	Weight
AZ210	10.2" x 14" 260 x 355mm	0 - 999 Seconds	8 x 15W	550 x 485 x 170mm	16.0 kg
AZ220	13.8" x 21" 350 x 535mm	0 - 999 Seconds	12 x 20W	720 x 580 x 170mm	25.0 kg
AZ326	20.4" x 36.5" 520 x 927mm	0 - 999 Seconds	24 x 20W	890 x 1031 x 215mm	60.0 kg

* vacuum pip is 25mm diagonally in from top left corner of the exposure area.

Order Code		Price 1+	Price 3+	Price 5+
300-030	AZ210	£660.00	£625.00	£595.00
300-150	AZ220	£825.00	£785.00	£745.00
300-045	AZ326	£1895.00	£1795.00	£1695.00

UV EXPOSURE UNITS

AY Vacuum UV Units

Low profile design
Touch membrane control
0-999 second electronic timer
Vacuum for ultimate reproduction

AZ Units
Double sided vacuum exposure
Simultaneous exposure = no registration problems.

PCB PROCESSING EQUIPMENT

Bench top PCB processing tanks. Injection moulded as one piece - no risk of leaks from welded seams.

Spray Wash

Bubble Etch

PCB Processing Tanks

Mega is the leading manufacturer of small PCB processing tanks which are used with great success in both Industry and Education. The successful proven design features self contained units each of which are free standing and will accept boards up to 320 x 260mm (12.6" x 10.23"). Each unit is formed in two parts, the high density polypropylene inside tank being injection moulded as a single piece. This method of construction has proved to be far more efficient than the old method of welding together several vacuum formed parts which by design gives inherent danger of leaks from joins. This one piece design is an important safety feature which should be considered when choosing PCB tanks. This inside tank has an integral top surround, which secures over the second of the two parts, a rigid rotationally moulded polyethylene outer case. A splash proof lid with full length board holder mesh covers a working area of 5 litre capacity. The board holders feature yellow side clips which can be secured to close the sides of the mesh when very small boards are being processed.

For added safety the inside tank is bolted to the outer case at the bottom of the unit. This must be removed before access to electrical components. Where applicable, the specially developed 500 watt heater with protective silica sheath is externally mounted in the tank, as is the thermostat sensor. The heater is fitted with an internal re-settable safety device to protect the tank if it is inadvertently turned on without any liquid in. All splash proof electrical controls including a variable thermostat setting are located in a recessed panel on the case front, which prevents liquid getting in contact with the electrics.

For ultimate convenience of use we recommend all our PA processing tanks are used in conjunction with the Process Tank Workstation Tray featured on page 16. We also recommend that all tanks are used with a RCD power break device such as the unit featured on page 47.

All the PA series tanks are designed to be modular, the following being an ideal processing sequence:

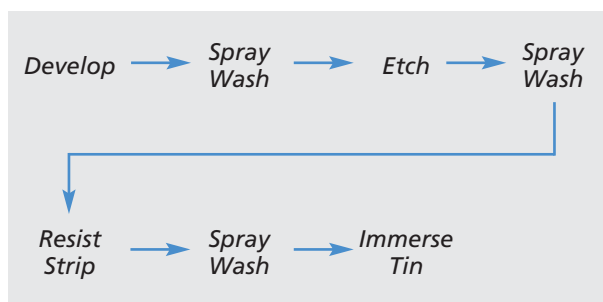

PA103 Spray Wash



This tank contains two spray wash bars at the top, driven from a single mains water inlet, between which the developed, etched stripped or tinned board can be suspended to be rinsed. A bottom tube permits used water to be run off to waste. Width 180mm, Depth 525mm, Height 380mm.

Order Code		PRICE (EACH)		
		1+	3+	5+
500-002	PA103 Spray Wash	£130.00	£119.00	£112.50

PA104 Bubble Etch



This, the most popular of single tanks, includes the heater and thermostat sensor as described above and has a pump fitted which forces air through two bubble bars to provide efficient and even etching. Illuminated switches control mains power and the pump whilst a neon indicates heater operation. The switches and neon have splash proof covers. The temperature is set by adjusting the variable thermostat control knob. (Optimum temperature for Ferric Chloride 45 °C). The tank is supplied with a syphon, IEC socket and 2 metres mains lead with moulded 13 amp plug. Width 180mm, Depth 525mm, Height 380mm.

Order Code		PRICE (EACH)		
		1+	3+	5+
500-003	PA104 Bubble Etch	£209.00	£189.00	£179.00

PA107 Universal - Develop, Strip or Tin



Complete with thermostatically controlled heater to cover PCB chemical temperature range of 10°C to 55°C. The tank can be thus selected for DEVELOP (25°C), RESIST STRIP (45°C) or IMMERSE TIN (21°C). Neons indicate when the mains heater is operative. Supplied complete with a syphon, IEC socket and 2 metre mains cable with moulded 13 amp plug. Width 180mm, Depth 525mm, Height 380mm.

Order Code		PRICE (EACH)		
		1+	3+	5+
500-004	PA107 Universal Tank	£170.00	£154.00	£146.00

PA210 Two-Tank Unit - Etch and Wash



An improvement over a standard Bubble Etch Tank. This unit is the same as the PA104 Bubble Etch Tank with the addition of an integral spray wash tank. The spray wash is solenoid operated and all electrical controls are on the front panel. Connections are provided at the rear for drain and cold water requirements. The integral spray wash tank offers safer and more efficient etching of boards than a standard bubble etch tank and being wider also gives greater stability. Complete with an IEC socket and supplied with 2 metres mains cable with moulded 13 amp plug and a syphon. Width 275mm, Depth 525mm, Height 380mm.

Order Code		PRICE (EACH)		
		1+	3+	5+
500-005	PA210 Etch/Wash Two-Tank	£265.00	£243.00	£230.00

PA310 Tri-Tank Unit - Develop, Wash and Etch



Our best selling and most popular PCB processing unit. A self-contained triple process unit with built-in DEVELOP / SPRAY WASH / BUBBLE ETCH functions providing a convenient bench standing system. The PA310 eliminates the normal untidiness associated with producing PCBs to the solderable-etched stage.

A RESIST STRIP / SPRAY WASH / IMMERSER TIN combination can be added to provide a full PCB processing run. Function tanks and splash proof controls are as standard, with all electrics brought together on the recessed front panel. The connections are provided at the rear for drain and cold water requirements. Complete with IEC socket, 2 metre mains cable with moulded 13 amp plug and two syphons. Width 400mm, Depth 525mm, Height 380mm.

Order Code		PRICE (EACH)		
		1+	3+	5+
500-006	PA310 Tri-Tank	£435.00	£395.00	£375.00

PA318 Tri-Tank 12" x 18" - Develop, Wash & Etch



For those requiring a larger three tank unit the PA318 is available. Featuring a larger fabricated outer and larger inner tanks, panels to 12" x 18" can be processed. The same processing sequence as the PA310 is offered, namely develop/wash/etch.

Order Code		PRICE
500-081	PA318 18" x 12" Tri-Tank Dev/Wash/Etch	£625.00

PCB PROCESSING EQUIPMENT

Bench top PCB processing tanks. Injection moulded as one piece - no risk of leaks from welded seams.

Universal Process

Etch/Wash

Develop/Wash/Etch

PCB 500S Labstation

A very popular multi-purpose PCB processing unit specifically developed to satisfy demands from both the educational and industrial sectors.

The unit features all the advantages of our normal 5 tank processing units with the added benefit of an integral sink with hot and cold water to keep PCB processing clean and efficient.

Possible processing sequences are: Develop / Wash / Etch / Wash / Resist Strip

OR Develop / Wash / Etch / Wash / Immerse Tin.

It is recommended that the last tank be used for tinning and the Photoresist is stripped in the sink with a SN120 strip applicator.



PCB PROCESSING EQUIPMENT

The most popular free standing processing unit which features the added benefit of a Hot and Cold water sink.

Features of this unit include :

- Choice of Tank sizes
- One piece polypropylene moulded top incorporating a sink and hot/cold mixer tap.
- Three chemical process tanks separated by two integral spray wash tanks.
- 10" x 12" tanks moulded as 'one piece', - eliminates the risk of splits from welds or seams.
- Protected control panel conveniently mounted in the front of the unit which controls heaters, air pumps and spray wash tanks.
- RCD current trip socket supplied as standard.
- Standard single phase 240/50Hz 13 amp supply required.
- Hot and cold water inlets are through standard washing machine hoses provided, draining from standard 32mm push fittings also provided.
- The cabinet itself is of steel construction clad with polypropylene sheeting and incorporates a lockable storage facility. Doors are manufactured from PVC.

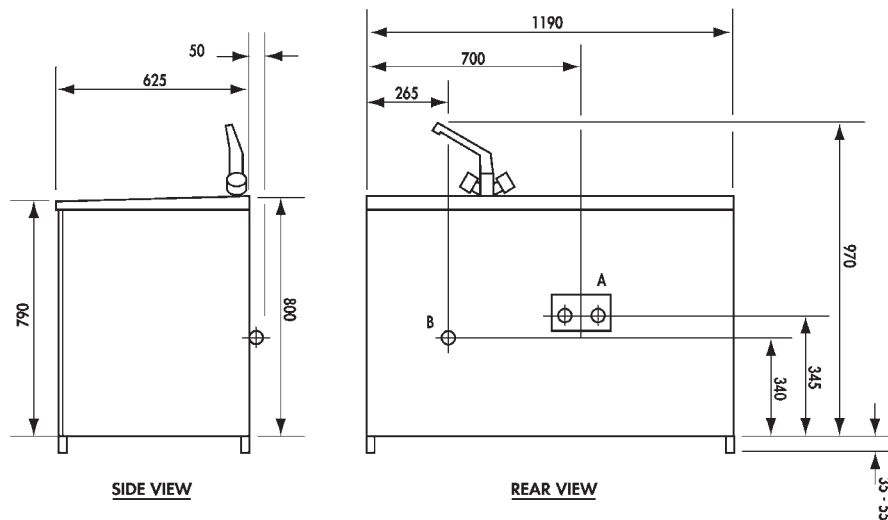

SERVICES

- A WATER SUPPLY INLET HOT & COLD
- B WASTE WATER OUTLET

Each Labstation can be purchased with or without a chemical starter kit. Purchasing the chemicals in this way offers a saving of over 25% of their normal purchase price. This basic kit for the PCB500S consists of one of each of the following: 4006V05 developer; 2.5kg Ferric etchant; PC168 tin; SN120 Photoresist strip applicator and a PC182 scrub block.

As the PCB520S has larger tanks double quantities of developer, etchant and tin are supplied. Chemical starter kits are not available separately.

Order Code		Price 1+	Price 3+
500-007	PCB 500S Labstation (10" x 12")	£1,250.00	£1,185.00
500-040	PCB 500S with Chemical Starter Kit	£1,290.00	£1,225.00
500-008	PCB 520S Labstation (12" x 18")	£1,360.00	£1,295.00
500-041	PCB 520S with Chemical Starter Kit	£1,450.00	£1,375.00

PCB PROCESSING EQUIPMENT

The most popular free standing processing unit which features the added benefit of a Hot and Cold water sink.

Jet 34d Static Spray Processor. Panels to 300 x 500mm

PCB Production Lines

Complete 7 Tank Processing Lines.

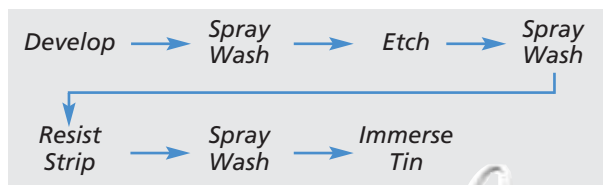

- 10" x 12" or 12" x 18" board capacity
- Processed and tinned PCBs in under 20 minutes
- Easy emptying of tanks from bottom drain, no syphoning
- RCD current trip socket supplied as standard

These units are very similar to the Labstations shown opposite but they include an extra spray wash and process tank. This enables the complete processing sequence to be undertaken in one compact free standing unit. Each tank is moulded from polypropylene. The 10" x 12" tanks from a single injection moulding and the larger 12" x 18" from two injection moulded tanks welded together and reinforced. All tanks have bottom drains so no syphoning is needed when the tanks are emptied. The cabinet itself is of a steel construction clad with polypropylene sheeting and incorporates a lockable storage facility. Doors are manufactured from 6mm thick black PVC. Both the PB710 for 10" x 12" boards and the PB720 12" x 18" boards are available with or without a sink fitted. The above illustration features a unit with a sink. A chemical starter kit is available which offers a saving on chemicals purchased separately. Order 2 kits for a 12" x 18" unit.

Dimensions

PB710/720 835mm (W) x 578mm (D) x 900mm (H).

PB710S/720S 1185mm (W) x 578mm (D) x 900mm (H).

Order Code		Price Each 1+	Price Each 3+
500-009	PB 710 Bench Line (10" x 12")	£1,370.00	£1,300.00
500-010	PB 720 Bench Line (12" x 18")	£1,460.00	£1,385.00
500-048	PCB710S Bench Line with Sink (10" x 12")	£1,520.00	£1,275.00
500-049	PCB720S Bench Line with sink (12" x 18")	£1,620.00	£1,540.00
600-041	Bench Line chemical starter kit for 10" x 12" unit (order 2 for 12" x 18" unit)	£59.00	£56.50

Jet 34d Spray Etching Machine



The Jet 34d is a low cost rotary etching machine ideally suited to the manufacture of prototype and small batch quantities of PCBs. As well as etching the unit can also be used for spray developing and spray resist stripping. The machine is of a sturdy PVC construction and is mounted on a stand which places the machine at a convenient working height. Etching solution is contained in a tank at the base of the machine. It is heated by a powerful quartz heater which assures a short warm up time and constant temperature which is controlled electronically. Boards up to 300 x 500mm can be etched although several smaller boards can be placed in the special board carrier, the handle of which protrudes out of the machine eliminating operator contact with the etchant.

The machine etches one side at a time and so for double sided PCBs the board holder is rotated 180° before the second etching cycle. In front of the etching chamber is a built in overflow wash tank for the rinsing of the etched boards. The triangular form of the body of the machine makes it ideal to place in a corner of a room. The efficiency of this spray etcher has been proven by line resolution of better than 0.1mm and etching speed of only 90 seconds with fresh ferric chloride.

Maximum Panel Size:	300 x 500mm
Sump Capacity:	30 litres
Dimensions:	Width 650 x Depth 690mm
Electrics:	220-240V/50Hz 1ph.

Order Code		Price
35-16046	JET 34d	£1,595.00

ROTA-SPRAY The Rota-Spray Processor has many advanced features making an ideal upgrade from a Bubble Etch Tank.

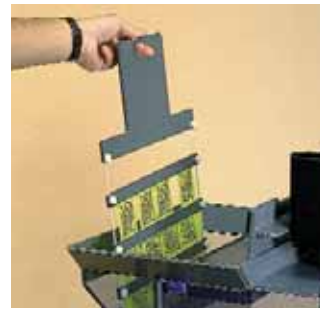
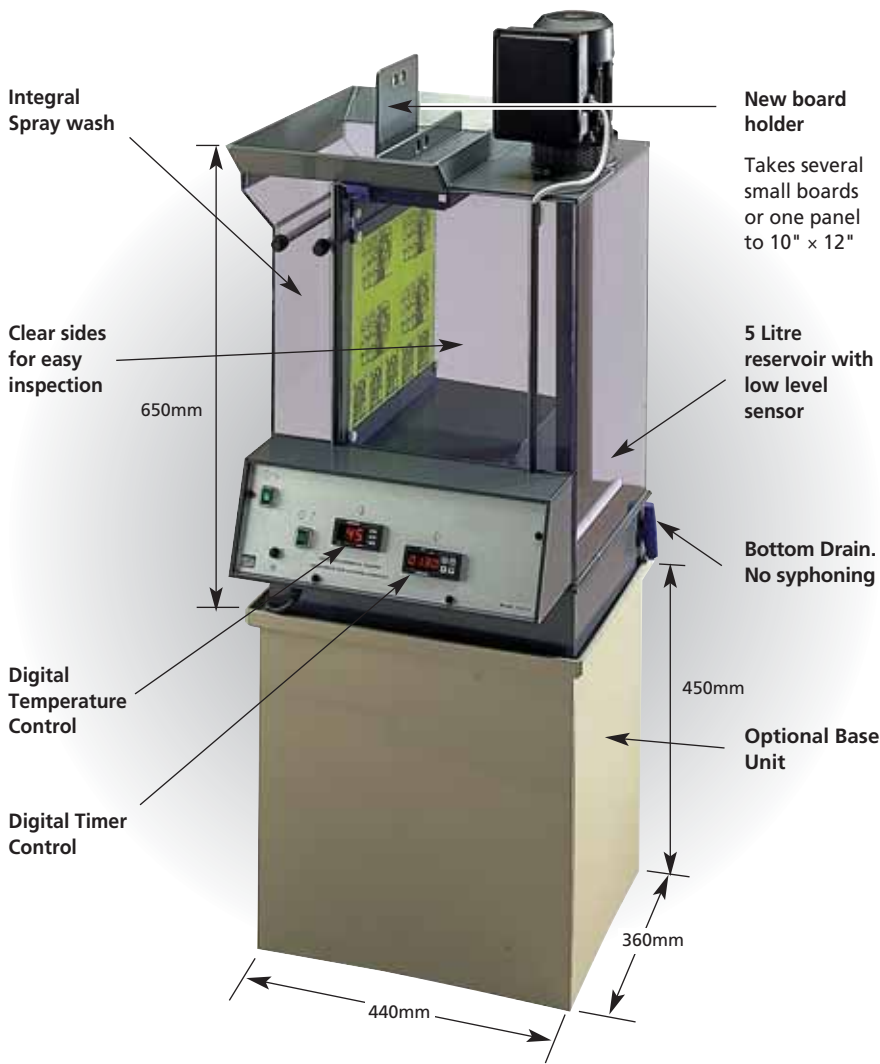

PCB PROCESSING EQUIPMENT ROTA-SPRAY

Fast and efficient etching and developing with the Rota-Spray Processor

The Rota-Spray etches 1oz (35 μ m) PCBs with Ferric Chloride in less than 90 seconds which is 3-4 times faster than a Bubble Etch Tank. The motor rotates a hollow column up which the etching solution is drawn, before being sprayed out at the panel via a number of predrilled holes in the column. The unit will spray one side of a panel at a time. The board holder can then be rotated 180° to process the second side. The Rota-Spray has a 10" x 12" (254 x 305 mm) board capacity and the new board holder will take a number of multiple small boards, or one large board. The low profile design of the board holder means less processing chemical collects on it keeping processing cleaner. The Rota-Spray features a digital timer which controls the processing time. Another benefit is that as the board is not immersed in liquid, there is no over-processing after completion, this makes over-etching very difficult. Another digital control module sets the temperature accurately. The Rota-Spray has a transparent case design which means panels can be examined after processing without the operator having to remove them. Next to the etch chamber is an integral spray wash tank, fitted with adjustable spray bars, that washes the entire board holder to keep the whole etching process clean. As well as an etching unit the Rota-Spray can be used to develop photoresists. The etch chamber has a bottom drain with secure fastening so no syphoning is necessary when the etching solution needs replacing. At the top of the unit there is a splash hopper which helps to contain chemistry to aid clean processing and a safety cut-out on lid cuts off the motor if lid is raised during etching. An optional Base Unit is available which places the top of the processing tank at an efficient working height of 110cm.

Liquid Ferric Chloride is recommend for use with the Rota-Spray. See 600-015 on page 32.

Order Code		Price
500-702	Rota-Spray Processor Model	£835.00
500-707	Rota-Spray Base Unit	£71.00

Testimonials from customers of the Rota-Spray

After years of using the etch tanks, we bought a Rota-Spray. The Rota-Spray has brought etching into the 21st century. It's quicker, cleaner and more efficient, producing an industry standard result without spending a lot of time or money.

The Rota-Spray etch/developer system is a major, low-cost breakthrough for the production of PCBs in schools. It is quick, clean and produces excellent quality PCBs. The temperature and processing times can be set accurately through digital controllers, which greatly improves quality control. Being able to examine the PCBs without removing them from the Rota-Spray is an added bonus. It is one of the best pieces of equipment the school has purchased for many years.

The Rota-Spray we recently purchased from Mega Electronics has resulted in the manufacture of high quality PCBs in a much faster time than we were previously able to achieve. It's simple and safe and easy to use by students and has drastically reduced the amount of mess made during manufacturing PCBs. A great investment for any department manufacturing PCBs.

PCB PROCESSING EQUIPMENT

'Splash' Double Sided Spray Etcher. PCBs to 210mm x 300mm.

Splash

A professional PCB double sided spray etching machine which can also be used for spray developing. The Splash Etcher will process boards to 210mm x 300mm. As with most vertical spray processors of this type this machine will etch 1oz (35 µm) copper boards in approximately 90 seconds.

The unit features a magnetic driven spray pump and 1000W heater. The liquid temperature is thermostatically controlled and there is inbuilt over-heat protection and a safety switch on the lid. The digital timer counts down the time during operation and features an auto-reset facility and an audible buzzer.

A special titanium board holder is included to enable both sides of the board to be etched simultaneously and the machine has an integral rinse tank.

Max board size:

210mm x 300mm

Power supply:

230 V~, 50 Hz approx. 1150VA

Dimensions (L x W x H):

60 x 66 x 20cm

Tank capacity:

25 ltr

Weight:

30 kg



Order Code		Price
35-16047	Splash Double Sided Spray Etcher	£2,190.00

'Splash Centre' Double Sided Spray Processing Station. PCBs to 210mm x 300mm.

Splash Centre

The Splash Centre features Splash Etcher with integral static tanks system with four process tanks, a squeegee drying unit and a spillage tray.

The four tanks from (left to right) are normally used for:

- Static pre rinse
- Static plus fresh water spray rinse (including foot-switch)
- Tank with basket and liquid movement via an integral pump, for resist stripping or developing.
- Spare tank, which can be used for chemical tinning

Max board size:

210mm x 300mm

Power supply:

230 V~, 50 Hz approx. 1150VA

Dimensions (L x W x H):

100 x 67 x 121cm

Weight:

46 kg



Order Code		Price
35-16048	Splash Centre	£3,480.00

Conveyorised Spray Processing Equipment

A range of Conveyorised Processing Modules consisting of high quality double sided units for developing, stripping and etching various materials to 500mm wide. These machines offer the ultimate in efficiency for either PCB or metal etch sign applications. The conveyor takes the material through the process chamber and a rinse chamber so completely clean panels exit the machine. 500mm modules should be ordered with a stand but the 300mm modules can be bench mounted.

Features include:

- 500mm or 300mm conveyor widths
- Modular construction
- Variable Spray Pressure
- Full safety features
- Digital temperature control
- Low maintenance
- Double filtration of the chemistry
- Low voltage control circuits.

Accessories available for the processor include a stand, link inspection modules, catch trays and cooling systems.



Illustrated model
DL500DS with stand

Description	Chemical spray processor including mains water rinse
Process chamber	460mm all models
Mains water rinse chamber	380mm for CP500, 295mm for CP300
Spray bars - top	4 process chamber, 1 rinse chamber
Spray bars - bottom	4 process chamber, 1 rinse chamber
Nozzle type	Poly v-jet
Nozzles per tube	5 + 6 for CP500, 3 + 4 for CP300
Pressure indication	Optional extra
Pressure control	Adjustable over full operating range
Re-circulating pump	CP500 - 0.75kW magnetic drive centrifugal pump, 0.5kW for CP300
Conveyor drive	Worm and wheel
Speed range	Variable speed d.c. shunt wound motor
Speed direction	0-2 metres/minute
Temperature range	Ambient to 50°C ± 1°C
Controller	Digital (standard)
Cooling	Factory build optional extra
Sump capacity max.	CP500 - 90 litres. CP300 - 30 litres
Sump capacity min.	CP500 - 50 litres. CP300 - 25 litres
Liquid low level and shut down	Warning lamp
Construction materials	P.V.C. Titanium, Hyperlon, PE1000, Vinylester, H.M.P., P.V.D.F.
Lids	Glass inner and outer with P.V.C. seals
Covers	P.V.C.
Safety switches	Reed magnetic on outer lids and rear cover
Voltage	220/240v 50Hz (13A plug)
Dimensions	Height CP500 - 810mm. CP300 - 655mm Width CP500 - 1000mm. CP300 - 795mm Length CP500 - 1120mm. CP300 - 1050mm
Mounting Frame	Polypropylene box section (Optional extra)
Heater	2Kw Hair Pin Titanium



Order Code	CP500DS Model 500mm	Price
500-202	CP500DS Conveyorised Processor 500mm wide D/S	£7,085.00
500-202-1	Stand for CP500DS Conveyorised Processors	£300.00
500-202-2	Catch tray for CP500DS Conveyorised Processors	£260.00
500-202-3	Cooling system CP500DS Conveyorised Processors	£560.00
500-205	300mm extension for CP500DS Conveyorised Processors	£380.00
500-202-P	Packing crate for CP500DS	£207.00

Order Code	CP300DS Model 300mm	Price
500-400	CP300DS Conveyorised Bench Processor 300mm wide D/S	£5,375.00
500-400-1	Stand for CP300DS Conveyorised Bench Processors	£300.00
500-400-2	300mm Catch tray for CP300DS Conveyorised Bench Processors	£260.00
500-400-3	Cooling system CP300DS Conveyorised Bench Processors	£560.00
500-400-4	Optional extraction spigot for CP300DS Bench Processors, standard on CP500DS	£90.00

PCB PROCESSING EQUIPMENT

Spray Processing Modules

300mm wide
500mm wide
Double Sided Processing

Accessories

Stand

Link/Inspection modules

Cooling Systems

Catch Trays

Through Hole
Plating

ABC Copper
Plating for
simple, efficient
and consistent
PTH boards

Will plate
standard copper
laminates plus
PTFE and
Polyimide

**ABC Copper Plate System, Simplicity
Itself Using The PL903/4 units**



MAIN FEATURES

- Only 4 Process Functions, plus plating.
- Wide window of operation.
- Specially developed ABC Chemistry already being used by European PCB Manufacturers.
- None of the nasty chemicals associated with other plating systems, (e.g. no Formaldehyde).
- Line time less than one hour - half that of other systems. Stable chemistry even when used irregularly.
- Minimum analysis - mostly done by replenishment (no specialist operator required).
- Very compact equipment - ideal for use where space is limited.
- Solid state controls, dual current output - plating timer - re-settable amp/hour counter.

Mega's ABC Plating Lines are for the production of high quality Prototype and Production quantities of Plated Through Hole boards. The process has none of the complexities of older style methods of production which are both time consuming and require expensive monitoring of processes on a daily basis. The heart of the system is our patented chemistry which has only four processes to prepare a panel to be electrolytically plated. Analysis of the chemistry is minimal, and so simple is the chemistry, we call it ABC. The Plating Lines feature electrolytic plating power supplies with controllers with membrane touch pad and digital read out meters to set volts, current, plating time and amp hours.

The exact method of producing a Through Hole Plated Board is via PANEL PLATING and this is described in detail on our web site. In essence it involves drilling a blank PCB laminate, plating the holes with Copper and using Dry Film Laminate image the circuit and cover the holes to protect them from the etchant. A Dry Film Laminator and CNC drill are essential pieces of equipment for this process.



Processing Sequence

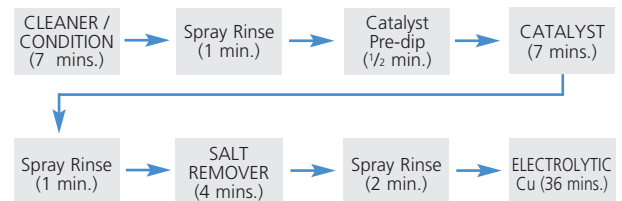

	PL903S	PL904S
Max. Panel Size:	12" x 10" (305 x 254mm)	18" x 12" (457 x 305mm)
Max. finished PCB:	11.5" x 9" (292 x 228mm)	18" x 11" (457 x 280mm)
Tank capacity:	Process 5L, Plating 25L	Process 10L, Plating 50L
Rectifiers:	PL903S 1 x 50A,	PL904S 1 x 100A,
Agitation:	Mechanical to all process stages & air to plating	

	All units
Dimensions:	1500 x 620 x 910mm.
Electrics:	Single phase 220/240V 50Hz or 110/120V 60Hz.
Heaters:	500W Silica sheath.
Water in:	Standard washing machine hose fittings supplied.
Water out:	32mm push fit polypropylene drain.

**Power Supply Features -
common to all copper plating units.**

1. Independent Anode set current with digital meters
2. Set plating current time 0-99 minutes, digital.
3. Pause facility - disconnects plating current at any period - pressing run allows process to continue until plating time is completed.
4. 0-9999 Digital Re-settable Amp hour meters.
5. Sealed Membrane Front Panel Overlay with touch panel controls.



Order Code		Price
500-085	PL903S 'ABC' Copper Plating Line 10" x 12" for Panel Plating 1 x 50A	£4,765.00
500-086	PL904S 'ABC' Copper Plating Line 12" x 18" for Panel Plating 1 x 100A	£5,945.00
500-159-2	'ABC' Copper Plating Line Chemical Starter Kit for 10" x 12" (order 2 kits for 12" x 18" line)	£350.00
500-160-1	'ABC' Copper Plating Line Replenishment Kit (for 10" x 12" line - order 2 kits for 12" x 18" line)	£129.00
400-260	18 micron double sided copper laminate 12" x 18" sheet	£4.95
400-261	18 micron double sided copper laminate 12" x 24" sheet	£6.95

Favorit Press – Mechanical Through Hole Plating

Hand-operated machine, especially for mechanical through-hole-plating purposes. Professional through-hole-plating by individual tools for each rivet diameter. Optimal contacts, even without soldering. Favorit offers high quality results at a low cost level.



- Adjustable depth limiter
- Maximum board size 400mm, throat depth 200mm
- Each press supplied with 1000 rivets and tools
- Different tools and rivet sizes available
- Size: W 95mm x H 210mm x D 300mm
- Weight: 4 kg

Rivets	Technical Data		Standard Tubular rivets according to DIN 7340, Form A		
	Inner dia mm	Outer dia ±0.03mm	Length ± 0.10mm	Head dia ± 0.15mm	Wall thickness ± 10%
	0.4	0.6	2.2	0.9	0.1
	0.6	0.8	2.2	1.3	0.1
	0.8	1.0	2.2	1.6	0.1
	1.0	1.4	2.5	2.2	0.2
	1.2	1.6	2.6	2.6	0.2
	1.5	1.9	2.7	3.1	0.2

NOTE: When drilling on CNC machines, the drill diameter should be 0.1mm larger than the above outer diameter

Order Code		Price
700-025	Favorit with 0.6mm Tool & 1000 Rivets	£255.00
700-027	Favorit with 0.8mm Tool & 1000 Rivets	£255.00
700-028	Favorit with 1.0mm Tool & 1000 Rivets	£255.00
700-029	Favorit with 1.2mm Tool & 1000 Rivets	£255.00
700-030	Favorit with 1.5mm Tool & 1000 Rivets	£255.00
700-031	Favorit Tool Set 0.4mm	£63.00
700-025-1	Favorit Tool Set 0.8mm	£63.00
700-028-1	Favorit Tool Set 1.0mm	£63.00
700-029-1	Favorit Tool Set 1.2mm	£63.00
700-030-1	Favorit Tool Set 1.5mm	£63.00
700-025-4	Rivets 0.4mm (1000 Per Pack)	£15.25
700-025-3	Rivets 0.6mm (1000 Per Pack)	£15.25
700-025-2	Rivets 0.8mm (1000 Per Pack)	£15.25
700-028-2	Rivets 1.0mm (1000 Per Pack)	£15.25
700-029-2	Rivets 1.2mm (1000 Per Pack)	£15.25
700-030-2	Rivets 1.5mm (1000 Per Pack)	£15.25

IONEX

The name IONEX stands for IONEXchanger, which is the very heart of this modern wastewater treatment system. In total it consists of a two-stage filtration, two ion exchange and one PH-levelling unit.

IONEX is ideally suited for all wastewater-cleaning processes in modern PCB prototype laboratories. The units exist in four variants with different sump capacities and ion exchange capacities. A separate spray pump/reservoir module is included with the closed loop K systems, (not shown on dimensions below).

This consists of a secondary reservoir and pump to enable the treated water to be introduced at pressure to the water inlet of the spray wash system being used.

- Removal of solids and all heavy metals
- Decrease of chemical oxygen demand
- Easy handling and operation
- IONEX A and B perform additional PH neutralization and discharge to the drain
- IONEX K types offer additional Kation capture for full rinse water recycling
- Polyethylene filter candle, 10 µm
- Lower and upper sump level control switch
- Storage sump for 110 (IONEX A) or 220 litres (IONEX B) of waste water



	IONEX A (KA)	IONEX B (KB)
Size (H x D x L):	1400 x 425 x 600mm	1400 x 850 x 600mm
Weight:	30 kg	60 kg
Tank capacity:	110 l	220 l
Cleaning capacity:	10 l/hour	20 l/hour
Power supply:	230 V~, 50 Hz, 50 W	230 V~, 50 Hz, 100 W

Order Code		Price
500-042	Ionex A Rinse Water Treatment Unit to drain 10l/h	£2,850.00
500-250	Ionex B Rinse Water Treatment Unit to drain 20l/h	£3,495.00
500-255	Ionex KA Rinse Water Treatment Unit Closed loop 10l/h	£3,925.00
500-260	Ionex KB Rinse Water Treatment Unit Closed loop 20l/h	£4,540.00
500-132	Replacement Filter candle for Ionex	£11.50
500-134	Replacement mineral granules for Ionex 5KG	£81.50

PCB PROCESSING EQUIPMENT

Favorit Mechanical PTH

IONEX Water Treatment

Mega 210 Multilayer Press



This high performance multilayer press was designed for PCB labs. to enable quick prototyping of multilayer PCBs of up to 6 or 8 layers according to industry standards. A compact and floor standing aluminium rack contains all parts of the unit including pressure supply, press plates and heaters. The large loading door that allows quick and easy access to the pressure part is of course security switch protected. A compressor, which is integral part of the Mega 210 press is stored in the back of the machine. In the front, you will find additional storage room for tools or boards (lower door). the unit is controlled by two digital and adjustable thermostats, one digital timer as well as a pressure valve with pressure meter. Double air ventilation is activated automatically during cooling cycle.

Features

Steps of multilayer production with the Mega 210 Press:

- boards are pinned and stack is inserted into press plates
- pressure is created
- heater is activated
- heating up procedure
- press procedure at preset temperature
- cooling down under pressure
- PCB stack is taken out of the machine

The sequence will take approx. 3 hours. Gross size of the PCBs is 250 x 350 mm which will result in PCB net size of 210 x 300 mm.

Order Code		Price
500-800	210 Multilayer Press	£10,800.00

For inner layers with large areas of copper a Black Oxide Line is recommended to ensure good bonding of the copper to the pre-peg. Further details on this line and associated chemistry can be found on our web site. Multilayer board packs are detailed on our web site.

Technical Data

Board size: 250 x 350mm gross	Cooling down: about 120 min.
Pressure: > 12 tons working	Machine size: W65 x D65 x H130 cm
Temperature: 175 °C (adjustable)	Power supply: 230V~, 50Hz, 16A
Heating up: about 30 min.	Warranty: 1 Year
Pressure time: about 60 min.	Technical details are subject to change without notice.
Weight: 130 kg net	

Mino General Purpose Ovens

- Temperature range 40°C to 250°C
- Easy clean powder coated
- Stainless steel interior
- Fan as an option



The exteriors of Mino ovens are constructed from sheet steel finished in an easy clean powder coat paint. The interior chamber is stainless steel. Each oven is fitted with fixed shelf runners and removable chrome plated wire grid shelves. The top vent is fitted with a clip to hold a mercury in glass thermometer. The ovens are heated by incoloy-sheathed elements. The control system comprises of a direct reading thermostat and overheat thermostat both with calibrated scales and tamper proof locks. The controls also include a mains switch and indicator and heat and overheat indicators.

Order Code		Price
500-193	MINO 30	£575.00
500-194	MINO 30 with fan	£730.00
500-195	MINO 50	£715.00
500-196	MINO 50 with fan	£845.00
500-197	MINO 150	£1,180.00
500-198	MINO 150 with fan	£1,305.00

Specifications		
MINO/30	MINO/50	MINO/150
Capacity: 30 Ltrs	Capacity: 50 Ltrs	Capacity: 150 Ltrs
Internal Dimensions H x W x D: 24 x 36 x 35 cms	Internal Dimensions H x W x D: 33 x 49 x 33 cms	Internal Dimensions H x W x D: 55 x 49 x 54 cms
External Dimensions H x W x D: Without Fan: 49 x 45 x 47 cms With Fan: 49 x 45 x 59 cms	External Dimensions H x W x D: Without Fan: 58 x 61 x 45 cms With Fan: 58 x 61 x 57 cms	External Dimensions H x W x D: Without Fan: 80 x 61 x 66 cms With Fan: 80 x 61 x 78 cms
No. of shelves: 2	No. of shelves: 2	No. of shelves: 3
No. of shelf positions: 2	No. of shelf positions: 3	No. of shelf positions: 5
Net Weight: 20 Kg	Net Weight: 26 Kg	Net Weight: 60 Kg

Complete Laboratory PTH Kits

PCB PROCESSING EQUIPMENT

Through Hole Plating Kits

10" × 12"

12" × 18"



Photoplot Artworks

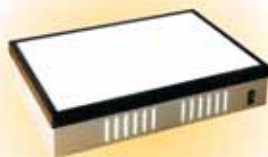

Check and Align Artworks



CNC Drill



Brush Clean



Through Hole Plate



Dry Film Laminate



UV Exposure



Spray Develop



Spray Etch



Resist Strip / Immerse Tin



Dry Panel



Cut to size

Kit Contents	10" × 12" Kit	12" × 18" Kit
Photoplot	FP8000	FP8000XL
Artwork Light Box	LB410 A3	LB410 A3
CNC Drill	CCD/2	CCD Auto tool change with compressor
Brush Cleaning Machine	500-110 Brush Cleaning Machine	500-110 Brush Cleaning Machine
ABC Through Hole Plating Line	PL903S	PL904S
Laminator	12" Roll Laminator	12" Roll Laminator
AZ U.V. Exposure Unit	AZ210	AZ220
2 × Spray Processors Develop/Etch	2 × Rota-Spray	2 × Jet 34d
Tri-Tank (Strip and Tin)	PA310	PA318
Board Dryer	27-22803 Board Dryer	27-22803 Board Dryer
Shear	Model 45 - 18" Shear	Model 45 - 18" Shear
Consumables	Full Set	Full Set

Order Code	Price
500-130 Kit 1 - Board Size to 10" × 12"	contact Mega
500-131 Kit 1 - Board Size to 12" × 18"	contact Mega

KITS TO MEET ALL BUDGETS ARE AVAILABLE ON REQUEST

Fume Extraction

Complete solutions from individual components - to custom designed, installed and commissioned systems

Fume Extraction



We constantly review our high quality product range to ensure that not only does it meet our customers current needs and offer excellent value for money but it is also safe to use. Safety could not be more prevalent in the selection of our PCB chemistry. For some years now we have not sold Sodium Hydroxide for use as a developer, the 4006 & 4007 developers do not contain this caustic chemical.

We are also often asked "Is fume extraction required for PCB processing?". Recently the services of an occupational hygienist from Thomson-MTS Limited were employed to carry out an analysis of our chemistry whilst it was being used to process PCBs. Mega tanks containing the following chemistry were used:

- Developer - 4006V05 (600-010)
- Etchant - Mega Ferric Chloride
- Etchant - Fine Etch Crystals (600-014)
- Resist Strip - PC 155 (600-019)
- Tin - PC 163/8 Immerse Tin (600-020/1)



The conclusion reached was that providing PCBs are produced in the same method and environment as the test conditions (i.e., using the above chemistry in Mega PCB tanks in a reasonably sized room) then **NO LOCAL EXHAUST VENTILATION IS REQUIRED.**

A full copy of the report is available, upon request.

For those using other PCB processing chemistry or techniques who would prefer a dedicated fume extraction system a range of canopies, stands, splash backs, fans and ducting are available from Mega. As every building is different it is impossible to specify a system to meet every individual's requirement without a site survey.

For those who are unable to arrange their own survey and installation we can arrange an initial survey (chargeable) and the fitting of a Mega extraction system which will be tested and the appropriate certification issued (requirement of law).

Canopies

6mm PVC canopies specifically designed to meet appropriate air flow requirements for local exhaust ventilation. The low level capture vents ensure approximately 80% of the fumes are removed at source, the remainder being caught by the higher level vent. Canopies are available in various widths up to 96". The 36" model being suitable for PB type benchlines and the 48" for Labstations and PL series plating lines.

Order Code		Price
305003	36" Extraction Canopy	£270.00
305014	36" Splash Back	£31.50
305004	48" Extraction Canopy	£295.00
305015	48" Splash Back	£40.50
prices of other sizes available upon request		

Where wall mounting is difficult and to enable the canopy to be located right over the PCB processing unit a steel mounting frame is available (not shown). Also available is an optional 760mm deep splash back which can be mounted between the bottom of the canopy and the top of the processing unit. Please ask for further details of frames, dampers ducting etc.

Corrosion Resistant Centrifugal Extraction Fans

A range of fans ideal for use with the above canopies. All are mounted on a rigid bracket and can be fitted in any orientation to alter the angle of discharge. Suitable for temperatures up to 49°C. They can be externally mounted for which protective weather proof cowls are available. Single phase - 240V, 3 phase also available.



Order Code		Price
305019	N15 - diameter 125mm	£515.00
305021	N20 - diameter 160mm	£560.00
305033	N25 - diameter 200mm	£675.00
305022	N30 - diameter 250mm	£970.00

A4 and A3 Dry Film Sheet Laminators



For smaller volume production these Hot Roll Laminators enable the user to apply Dry Film Photo-Resist sheets to a wide range of materials, such as Copper PCB Laminates, Stainless Steel and Brass etc. For 'one-off' or very small scale production they offer an economical alternative to the Roll Laminators opposite. One side is laminated at a time to a thickness of 3mm thick. All temperature and speed controls are microprocessor controlled with a pre-set condition which can be manually overridden. Temperature and speed number (1-6) are indicated on the LCD display. Cold lamination is also possible.

A4 Laminator - Max Lamination Width 235mm:
Dimensions (mm) 545W x 270D x 130H: Weight 11Kg

A3 Laminator Max Lamination Width 325mm:
Dimensions (mm) 545W x 270D x 130H: Weight 15Kg

Order Code		Price
27-22808	A3 Sheet Laminator	£695.00
27-22809	A4 Sheet Laminator	£570.00

Dry Film Solder Mask

Dry film solder mask, 75 micron thick. The green material is sheet laminated to a PCB. With an artwork, an exposure is made to UV and the unwanted areas developed away with Dry Film Developer before final curing. Data sheet available on our web site.

Order Code		Price
500-195-2	Dry Film Soldermask 12" x 5m	£35.00

Dry Film Photoresist and Developer

Negative working 40 micron dry film Photoresist for PCB and metal etching. Film supplied in packs of two rolls. Rolls can be used directly on roll laminators or cut to sheets for sheet laminators.

Order Code		Price Per pack of 2
500-024	12" Dry film x 30m	£86.50
500-021	12" Dry film x 150m	£280.00
500-055	18" Dry film x 150m	£420.00
500-057	24" Dry film x 150m	£560.00

Dry film Photoresist Developer is a special formulation specifically for the above dry film resist. Developer used at 30°C.

Order Code		Price
500-164	1 Litre to make 25 Litres	£10.50
500-162	5 Litres to make 125 Litres	£41.50

Dry Film Roll Laminators

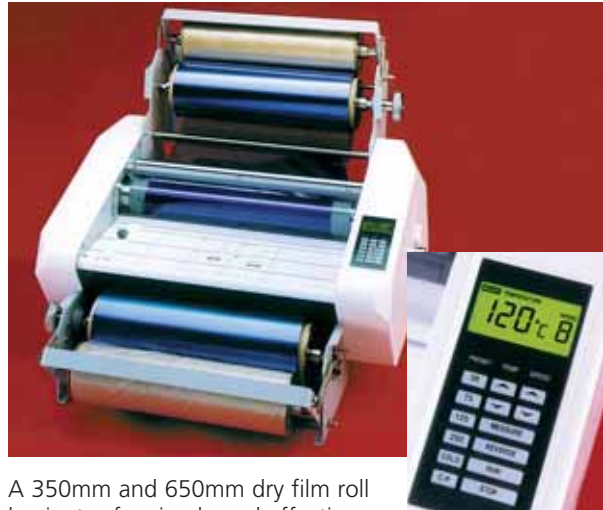

A 350mm and 650mm dry film roll laminator for simple and effective laminating of rolls of Dry Film Photoresist to various substrates. The units are particularly useful for both printed circuit board production and the lamination of dry film to brass, steel etc for metal etching applications. Both sides of the substrate are simultaneously laminated. The machines use accurate controlled temperature and feed and automatically remove the polyofin separator sheet of the dry film.

Main features include:

- Exclusive pre-set temperature and speed setting programs for a variety of applications just by Pressing a button on the digital display panel.
- Adjustable override controls for both temperature and speed to compensate for variations in material or conditions.
- Heater roller and pressure roller construction in silicon rubber allows roller gap adjustment ensuring correct pressure for panels up to 4 mm thick.
- Function button displays actual roller temperature during operation.
- Instant switch from Centigrade to Fahrenheit
- Warm-up time only 10 minutes due to the Infrared heater design which gives better heat distribution and control.
- Ready and Wait visual and audible signals alert operator to laminator readiness thus reducing errors.
- 8 Bit microprocessor digital heat controller permits precise setting and guarantees fast response times.
- Reverse function button allows easy film clear from the machine.

Max working width: 27-22800 model 340mm
27-22802 model 640mm

Temperature range: 0 - 160°C

Lamination speeds: 0 - 1.6 metres/min variable in 10 stages

Power requirements: 220/240v 50/60Hz Single phase 12Amp

Shipping 27-22800 model 670W x 500H x 690L

dimensions (mm): 27-22802 model 670W x 500H x 1010L

Shipping weight: 27-22800 model 35 kilos
27-22802 model 49 kilos

Order Code		Price
27-22800	12" Laminator	£2,495.00
27-22802	24" Laminator	£3,695.00

Roller Tinning Machines



Bench mounting roller tinning machines with 12" or 18" roller width. The solder tank is constructed from high grade stainless steel, suspended from a linkage mechanism. This allows it to be lowered easily from the coating roller for access and general maintenance. The two 1200 watt heaters ensure a fast heat up time, while the electronic temperature control system ensures that operating temperatures are accurately maintained. The machines are fitted with stainless steel covers which provide complete protection for the operator but allow quick and easy access to the tank for replenishing salts and solder.

Roller Tin Consumables can be found on our website

Specifications	IGP-305	IGP-480
Max board width:	305mm (12")	480mm (18.9")
Max board thickness:	12mm	12mm
Solder bath capacity:	12kg	18Kg
Heat up time:	20 mins	45 mins
(ambient to 240°C)	(approx)	(approx)
temperature control:	+/- 2°C	+/- 2°C
Throughput speed:	0-10	0-10
	metres/min	metres/min
Dimensions (mm):	850L x 330D x 490H	1020L x 330D x 490H

Order Code		Price
27-18043	IGP-305 12" Roller Tinning Machine	£2,490.00
27-18200	IGP-480 18" Roller Tinning Machine	£2,945.00

Brush Cleaning Machine

A professional brushing machine designed for use in small series production and laboratories.



- Bench top machine, wet processing
- Single side action
- Aluminium, PVC, Stainless Steel construction
- Transport top lid with security switch

- Working width 300 mm
- Board thickness 0.3 - 3 mm
- Conveyor speed 0.2 - 2 m/min
- Adjustable brushing pressure and oscillation speed
- Oscillation length 10 mm
- Mechanical drying by squeezing rollers
- Additional built-in hot air dryer

Technical Data		
Power supply:	230 V~, 50 Hz	
Brush Width :	300mm	
Usable width:	300 mm	
Oscillation Stroke:	10mm	
Water consumption:	approx. 6.8 l/min	
Oscillation frequency:	10 – 110 st / min	
Water supply connection:	Ø 19 mm	
Material thickness:	0.3 –3mm	
Weight:	72 kg	
Feed rate:	0 – 2m/min	
External dimensions (mm):	760L x 590W x 415H	
Brush Size:	Ø 89 * 310mm	
Brush Speed:	1360 r.p.m.	
Plate Size minimum:	60 * 120mm	
Current consumption:	maximum 10 amp	
Weight with filter:	80 kilos	

Order Code		Price
500-110	Brush Cleaning Machine	£4,950.00

PCB Board Dryer



This stainless steel bench top PCB drying machine dries wet circuit boards through a series of squeegee towelling rollers and a heated air knife.

The unit consists of four pairs of squeegee towelling rollers, the first pair rotate in a shallow water tank with a water level detector, this helps to capillary water trapped in the drilled holes. The second and third pairs of rollers remove excess moisture before the circuit board enters the heat zone where the high output blower air knife removes moisture from both surfaces of the board and from inside the holes. The board then exits through the last pair of rollers completely dry.

The electronic control module allows the operator choice of two heat settings with variable feed rates, thus giving optimum drying rates. The unit has an automatic over-run switch which operates the wet squeegee rollers at maximum speed for approximately ten minutes, with the heaters on, to part dry the rollers for future use.

Maximum panel width:	610mm (24")
Motor speed:	0-5 metres/Min.

Order Code		Price
27-22803	Board Dryer	£2,850.00

DM 9000 and DM 9001



Two powerful, cost effective, shears which have the ability to accurately cut PCB laminates, plastics up to 2.00mm thick and aluminium up to 1.5mm. An important feature of these shears is safety. Free access to the cutting area is prevented by heavy Perspex shielding extending along both sides of the blade. A safety latch is fitted to the pivot to prevent operation without it first being released. For positional accuracy the cutting bed is fitted with a rule which is recessed to assist in securing the PCB or sheeting whilst cutting is in progress.

The DM9000 has a cutting capacity of 203mm (8") and is extremely compact with an overall height of only 575mm and a footprint of 335 x 140mm. It has a cutting bed of 110mm wide from the blade although wider material can be cut.

The larger DM9001 will cut materials up to 305mm (12") and has a height of 670mm and a footprint of 440 x 245mm. It has a larger cutting bed 225mm wide from the blade although once again wider material can be cut.

Order Code		Price
700-400	DM9000 8" Shear	£159.00
700-500	DM9001 12" Shear	£209.00

18" Shear



A bench top shear with an 18" (457mm) cutting capacity suitable for cutting printed circuit board laminates, thin metal sheet and aluminium (1.5/2.0mm) or plastic labels / front panel materials. On lowering the operating handle, a spring loaded clamp is activated which holds the material securely during cutting, thus enabling cuts to be made with a minimum of effort.

These shears are composed of an epoxy powder coated cast aluminium frame fitted with hardened and ground steel blades. The shear has a clear acrylic front safety guard to protect the operator, whilst at the same time making it possible to see the blades so that the material to be cut can be aligned accurately. On the bed are both imperial and metric edge scales and fully adjustable front stop is supplied for batch work.

Shipping dimensions: 65cm x 48cm x 35cm 22KG.

Order Code		Price
27-18032	Model 45 18" Shear	£410.00

25" Shear



Similar to the above shear but with an increased cutting capacity of 25" (610mm) cutting capacity suitable for cutting printed circuit board laminates, thin metal sheet and aluminium (1.5/2.0mm) or plastic labels / front panel materials. Similar in design and operation to the 18" model except that a fully adjustable front stop and back stop are supplied for batch work.

Shipping dimensions: 90cm x 50cm x 45cm 45KG.

Order Code		Price
700-274	DM 525 25" Shear	£750.00

Details on higher capacity shears on request.

SHEARS

8"
12"
18"
or 25"

CORNER ROUNDER



ES420 Corner Rounder

An inexpensive invaluable tool to meet the demand for a quick corner rounding facility for plastic/metal labels and front panels. The table is effectively split into two halves, each containing 90 degree stops, in the angle of each is a hardened radius of either 6mm or 4mm. The punch has been ground to simultaneously marry both of these rounds when driven down by the cam actioned handle. The material to be rounded is slid from the left or right hand side positively into the stops, to leave an overhang which is sheared through by the punch to leave a clean corner of either 6mm or 4mm radius.

It should be noted that material originally cut out of square will result in an unbalanced round being removed. The table support column is mounted on a 5" x 5" steel plate with screw holes for bench fixing, although this will probably be unnecessary for most users.

Overall height with handle upright 8" (205mm) and weight 1.2Kg.

Order Code		Price
700-007	ES420 Corner Rounder	£135.00

SMALL PCB DRILLING MACHINE

Economical
Drilling System



Dremel Drilling Station

DM403 - High Speed PCB Drill

A 240v AC drill ideal for drilling PCBs with a variable speed control for speeds between 10,000 - 33,000 rpm. It features a sturdy shatter proof nylon housing and a dependable sleeve bearing 125 Watt motor and ball bearing driven shaft. A 1/8th" collet is fitted. Weight 450g.

DM405D Drill Stand

A drill stand to fit the Dremel drill. It has a robust arm containing an adjustable aperture in which the drill is held vertically. The arm slides against springs on two pillars fixed rigidly to a base plate of 230 x 150mm. Drill pillars can be switched to offer right or left handed use.

DM410 Dremel Drilling Station

A complete drilling station consisting of a DM403 variable speed Dremel drill, a Dremel Drill Stand and three tungsten carbide drill bits.

Order Code		Price
700-014	DM403 Variable Speed Dremel	£73.95
700-305	DM405D Dremel Drill Stand	£52.95
700-307	DM410 Dremel Drilling Station	£125.00

Variodrill High Speed Drilling Machine

The Variodrill is a high speed machine which combines drilling accuracy with an increased level of operator comfort.

The spindle, which has a fixed speed of 30,000 rpm, is located below the work table. The drilling cycle is initiated by pressing a foot switch, thus leaving both hands free to position the printed circuit board. The feed rate is continuously adjustable by means of a potentiometer at the front of the machine. Sighting of the drill is achieved by positioning the PCB so that the pad to be drilled is located beneath a target in a perspex plate fixed above the work table. Accuracy is increased by viewing the target through a magnifier.

The machine rests on an adjustable base which allows the work table to be tilted towards the operator, thus reducing operator fatigue.

The Variodrill is supplied as standard with a dust extraction unit which connects to the rear of the machine for



the machine.

FX-5R PCB Routing Machine

A modified version of the FX-5 Drilling Machine also suitable for routing PCBs. The machine has a fence and depth stop and is fitted with special bearings, allowing it to withstand heavy side loadings. The router is ideal for making cut-outs in edge connectors, shaping complicated contours, removing unwanted tracks, or chamfering



Specification

Spindle speed:	30,000 rpm (fixed)
Dimensions (mm):	L340 × W240 × H175
Maximum board width:	230mm (9")

Order Code

Price

28-18060	Variodrill	£1,050.00
----------	------------	-----------

effective removal of drilling debris.

FX-5 High Speed Drilling Machine

The FX-5 is a compact, high speed printed circuit board drilling machine, designed primarily for the development engineer, PCB manufacturer, or model shop. Its high accuracy and ease of operation make it ideal for drilling prototypes and small batches of PCBs. The machine is of a robust steel construction and features an integral fan to assist swarf removal. A work illuminating lamp, spring plunger for stack drilling and an adjustable dead-stop attachment are also included. The FX-5 offers a choice of two fixed operating speeds : 14,000 rpm or 18,000 rpm, switchable by means of a toggle switch on top of

Specifications

Dimensions (mm) :	L336 × W110 × H400
Maximum board width :	300mm
Drill Sizes :	0.5-4.0mm
Height under chuck :	44mm
Electrics :	220-240V AC 50Hz 1ph

Specifications

Spindle Speeds:	14,000 rpm, 18,000 rpm
Dimensions (mm):	L420 × W200 × H400
Throat clearance:	150mm
Chuck capacity:	0.5-4mm
Height under chuck:	44mm
Electrics:	220-240V 50Hz 1ph

Order Code

Price

27-18093	FX-5	£395.00
----------	------	---------

Order Code

Price

27-18095	FX-5R	£495.00
----------	-------	---------

CCD2 CNC Production Centre

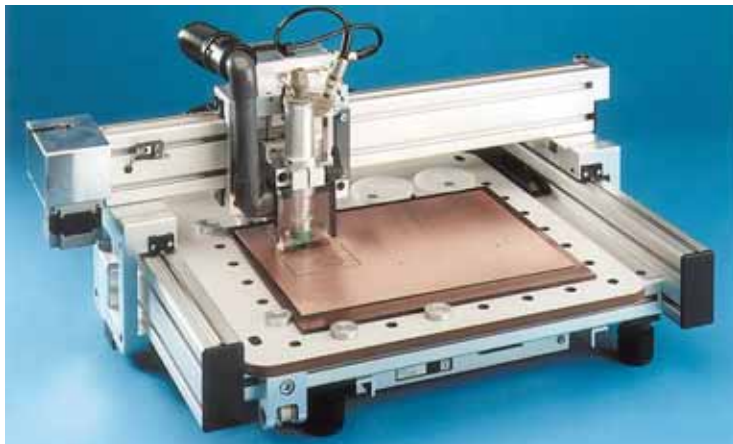

The CCD2 is the smallest in a range of CNC machines for drilling and routing of PCBs and other materials. All our CNC units can be used for 'Isolation Routing' where the unwanted copper to produce a PCB is removed mechanically rather than chemically etched. The CCD2 is the smallest and most affordable unit but it still has a processing area of 270mm x 320mm. All CNC machines are complete with drill and profile routing software. For Isolation Routing the IsoCam software is also needed but there is no need to buy the old separate 'Windows Black Box' as this is now supplied integrated in the CCD/2. With the supplied ROUTEPRO 2005 software tasks can be performed real time in Windows. All the CNC machines include a Kavo high frequency spindle (60,000 rpm) and software controlled Z-Axis for optimum processing. All machines accept industry standard tools. Floor standing or bench top enclosures are available with storage cabinet and lockable wheels.

Order Code		Price
700-001	CCD/2 CNC with intergrated 'Black Box' +RoutePro2005	contact Mega
700-002	IsoCam Isolation Routing Software	£650.00
700-005	CCD/2 Enclosure (Floor Standing)	£595.00
700-005-2	CCD/2 Enclosure (Bench Top)	£395.00

Special Features:

- Rigid and flat construction with low moving weights and high quality bearings for high-speed positioning.
- Machine bed with universal fixture system, suitable for both clamps and ref. Pins.
- KaVo high speed, 60,000rpm spindle motor, 150 W, including 1/8" (3.175 mm) chuck.
- Heavy duty stepper motor on Z-axis for true milling capability and correct tool speed.
- Standard travel area: 320 x 270 x 30 mm, Sizes (mechanics) approx:70 x 55 x 30 cm³ (W x D x H).
- Easy semi-automatic tool change, simultaneously 15 out of 99 tools per job.
- Smallest drill diameter: 0.3mm. Drill speed: 5 hits/s (=18,000 holes per hour).
- Integral depth limiting device for (isolation) milling and engraving on uneven surfaces.
- Driver software for Excellon, Sieb & Meyer or HP/GL data.
- All machine parameters software controlled and configurable, including Z axis.
- Step definition: 0.25 mil (= 0.00635 mm), precision +/- 1 step.
- Maximum speed per axis: 133 mm/s (=8 m/min).
- Sizes (mechanics) approx: 70 x 55 x 30 cm³ (W x D x H).
- Required desktop size: approx. 80 x 80 cm. Weight: approx. 23 kg.

Technical details are subject to change without notice

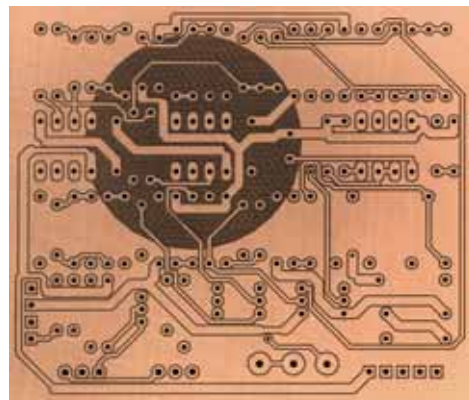

Accessories

Order Code		Price
13-111050	30° router for isolation routing and fine engraving	£9.15
700-013-8	60° router for isolation milling and rub out	£8.25

Drill Entry/Exit Board

High quality drill entry and exit board for precision drilling with a CNC drilling machine.

Order Code		Price			
		1+	5+	10+	25+
400-265	Melamine 0.8mm Drill Entry Board 12" x 18"	£0.75	£0.70	£0.68	£0.65
400-266	1.5mm Drill Exit Board 12" x 18"	£1.35	£1.28	£1.20	£1.10

CCD Production Centre

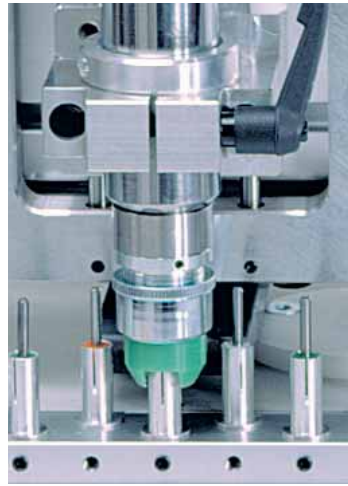
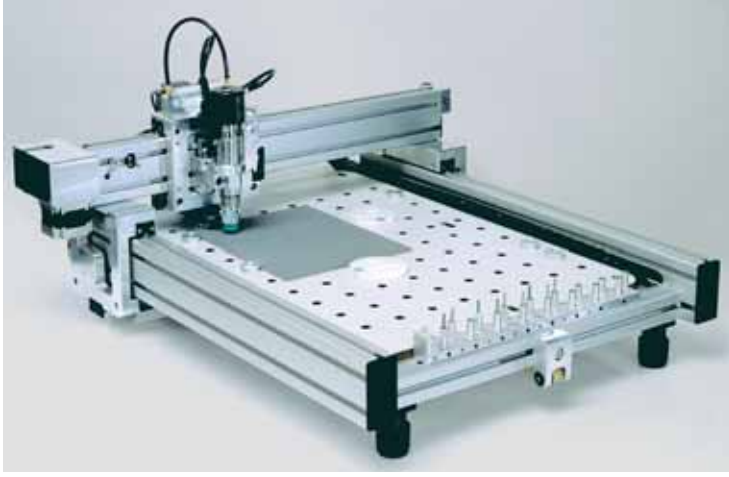

For a larger working area than the CCD2 the standard CCD is available in Manual or Automatic Tool Change versions. The maximum working area is approximately 324 x 495 mm. These high speed, accurate machines will drill PCBs, manufacture isolation routed prototype boards, and engrave a whole range of substrates including aluminium. For PCBs the machine will accept the drilling files created by most CAD software packages and will drill several boards in a stack. As with the CCD2 it is also possible to produce prototype PCBs without the use of etching chemicals, the method of production known as isolation routing.

A special piece of software is available, called IsoCam, which uses the data from the GERBER files to generate the corresponding outline shape. The whole operation can be performed 'real time' in Windows. The high speed and precision of these machines, together with a range of specifically designed sophisticated features (e.g. mechanical depth limitation) make this method of production highly accurate and efficient.

Order Code		Price
700-008	Auto Tool Cnc +Integrated Black Box +Routepro2005	Contact Mega
700-010-5	Compressor for Auto Tool change CNC Machine	Contact Mega
700-013	Manual Tool CNC +Integrated Blk Box +Routepro 2005	Contact Mega
700-002	IsoCam Isolation Routing Software	£650.00
700-013-4	Floor Standing Enclosure for Manual & Auto CNC	£695.00
13-111050	30° router for isolation routing and fine engraving	£9.15
700-013-8	60° router for isolation milling and rub out	£8.25

Special Features:

- Accuracy $\pm 0.001''$, Repeatability $\pm 0.0004''$.
- Machine bed with universal fixture system, suitable for both clamps and ref. pins.
- KaVo high speed spindle motor, 150 Watt, including 1/8" (3.175 mm) chuck.
- Software controlled spindle speed up to 60,000 rpm.
- Heavy duty stepper motor on Z-axis for true milling capability and correct tool speed.
- Standard travel area: 325 x 495 x 30 mm³ (max. available 500 x 600 x 45 mm³).
- Semi or fully automatic tool change (ATC) options available. Compressor required for ATC machine.
- Smallest drill diameter: 0.3 mm.
- Integral depth limiting device for (isolation) milling and engraving on uneven surfaces.
- Stand alone control unit (19" rack) connects to all standard PC's with 1 free serial port.
- Driver software for Excellon, Sieb&Meyer or HP/GL data.
- All machine parameters software controlled and configurable.
- Video and Screen Attachment (optional) available for inspection.
- Paste Dispenser (optional) available for solder paste and other dispensing applications.
- Enclosure (optional). A floor standing enclosure with storage facility and lockable wheels.
- IsoCam (optional) Isolation Routing software. A sophisticated software package which along with its many editing facilities enables Gerber files to be manipulated to a suitable format for 'Isolation Routing'.
- Step definition: 0.25 mil (=0.00635 mm), precision +/- 1 step.
- Maximum speed per axis: 133 mm/s (=8 m/min)
- Power supply: 220-240 V, 50 Hz, approx. 250 VA.
- Required desktop size: approx. 120 x 80 cm². Weight: approx. 32 kg.

Technical details are subject to change without prior notice.

CNC PRODUCTION CENTRE

CNC Drilling

Manual or Automatic Tool Change Machines

Working Area 324 x 495mm

Isolation Routing

Engraving

CARBIDE DRILL BITS

Over 50 sizes of Carbide Drill Bits in Straight or 1/8" Turbo Shank

Carbide Drill Bits

High grade solid carbide PCB drills available with 1/8th inch turbo shank. Solid carbide drills remain sharp for much longer than steel drills when drilling epoxy glass PCB laminates such as Fotoboard and Microtrak and should be used at high speed to produce good quality holes and avoid breakage. These drill bits can be fitted with drill collars for use with CNC drills.



1/8" Turbo Shank



Size (mm)	Part No.	Price			
		1 - 4	5 - 9	10 - 24	25+
0.50	13-111003-1	£2.30	£2.15	£1.99	£1.75
0.60	13-111005-1	£2.30	£2.15	£1.99	£1.75
0.65	13-111006-1	£2.30	£2.15	£1.99	£1.75
0.70	13-111007-1	£2.30	£2.15	£1.99	£1.75
0.75	13-111008-1	£2.30	£2.15	£1.99	£1.75
0.80	13-111009-1	£2.30	£2.15	£1.99	£1.75
0.85	13-111010-1	£2.30	£2.15	£1.99	£1.75
0.90	13-111011-1	£2.30	£2.15	£1.99	£1.75
0.95	13-111012-1	£2.30	£2.15	£1.99	£1.75
1.00	13-111013-1	£2.30	£2.15	£1.99	£1.75
1.05	13-111014-1	£2.30	£2.15	£1.99	£1.75
1.10	13-111015-1	£2.30	£2.15	£1.99	£1.75
1.15	13-111016-1	£2.30	£2.15	£1.99	£1.75
1.20	13-111017-1	£2.30	£2.15	£1.99	£1.75
1.25	13-111018-1	£2.30	£2.15	£1.99	£1.75
1.30	13-111019-1	£2.30	£2.15	£1.99	£1.75
1.40	13-111021-1	£2.30	£2.15	£1.99	£1.75
1.50	13-111023-1	£2.30	£2.15	£1.99	£1.75
1.55	13-111024-1	£2.30	£2.15	£1.99	£1.75
1.60	13-111025-1	£2.30	£2.15	£1.99	£1.75
1.65	13-111026-1	£2.30	£2.15	£1.99	£1.75
1.70	13-111027-1	£2.30	£2.15	£1.99	£1.75
1.75	13-111028-1	£2.30	£2.15	£1.99	£1.75
1.80	13-111029-1	£2.30	£2.15	£1.99	£1.75
1.90	13-111031-1	£2.30	£2.15	£1.99	£1.75
2.00	13-111033-1	£2.30	£2.15	£1.99	£1.75
2.05	13-111058	£2.30	£2.15	£1.99	£1.75
2.10	13-111034-1	£2.30	£2.15	£1.99	£1.75
2.20	13-111035-1	£2.30	£2.15	£1.99	£1.75
2.30	13-111036-1	£2.30	£2.15	£1.99	£1.75
2.40	13-111037-1	£2.30	£2.15	£1.99	£1.75
2.50	13-111038-1	£2.30	£2.15	£1.99	£1.75
2.60	13-111039-1	£2.30	£2.15	£1.99	£1.75
2.80	13-111041-1	£2.30	£2.15	£1.99	£1.75
2.90	13-111042-1	£2.30	£2.15	£1.99	£1.75
2.95	13-111067	£2.30	£2.15	£1.99	£1.75
3.00	13-111043-1	£2.30	£2.15	£1.99	£1.75
3.10	13-111069	£2.30	£2.15	£1.99	£1.75
3.15	13-111070	£2.30	£2.15	£1.99	£1.75
3.175	13-111057	£2.30	£2.15	£1.99	£1.75

Reground Carbide Drills

High quality pre-used tungsten carbide drill bits which have been reground to be as sharp as new. A considerable saving on new bit prices. All with 1/8" (3.175mm) shank. Supplied in packs of 10. Other sizes available in 0.05mm steps - ask for details. Drill collars below can also be fitted to these drills.

Order Code		Price		
		1+	3+	5+
68-1006	MM Carbide Drill 0.6mm PK of 10	£12.10	£11.50	£10.85
68-1007	MM Carbide Drill 0.7mm PK of 10	£12.10	£11.50	£10.85
68-1008	MM Carbide Drill 0.8mm PK of 10	£12.10	£11.50	£10.85
68-1085	MM Carbide Drill 0.85 mm PK of 10	£12.10	£11.50	£10.85
68-1009	MM Carbide Drill 0.9mm PK of 10	£12.10	£11.50	£10.85
68-1100	MM Carbide Drill 1.0mm PK of 10	£12.10	£11.50	£10.85
68-1105	MM Carbide Drill 1.05mm PK of 10	£12.10	£11.50	£10.85
68-1110	MM Carbide Drill 1.1mm PK of 10	£12.10	£11.50	£10.85
68-1115	MM Carbide Drill 1.15mm PK of 10	£12.10	£11.50	£10.85
68-1200	MM Carbide Drill 1.2mm PK of 10	£12.10	£11.50	£10.85
68-1300	MM Carbide Drill 1.3mm PK of 10	£12.10	£11.50	£10.85
68-1400	MM Carbide Drill 1.4mm PK of 10	£12.10	£11.50	£10.85
68-1500	MM Carbide Drill 1.5mm PK of 10	£12.10	£11.50	£10.85
68-1600	MM Carbide Drill 1.6mm PK of 10	£12.10	£11.50	£10.85

SC/FT Chip Breaker Routers

Tungsten Carbide printed circuit board routers with 1/8" (3.175mm) shank. The special geometry offers exceptional swarf removal, reduces radial load significantly and produces a very fine surface finish. Total length 38mm. Some popular sizes are offered below although other sizes from 0.8mm to 3.175mm are also available.

Order Code		Price
13-111160	SC/FT Chip Breaker Router 0.8mm	£3.40
13-111161	SC/FT Chip Breaker Router 1.0mm	£3.40
13-111162	SC/FT Chip Breaker Router 1.2mm	£3.40
13-111163	SC/FT Chip Breaker Router 1.5mm	£3.40
13-111164	SC/FT Chip Breaker Router 2.0mm	£3.40
13-111165	SC/FT Chip Breaker Router 2.5mm	£3.40
13-111166	SC/FT Chip Breaker Router 3.0mm	£3.40

RP Series Routers

Tungsten Carbide routers with 1/8" (3.175mm) shank for plastics and large rub outs of copper laminates. Total length 38mm.

Order Code		Price
13-111180	RP series Router 0.8mm	£4.65
13-111181	RP series Router 1.0mm	£4.65
13-111182	RP series Router 1.2mm	£4.65
13-111183	RP series Router 1.5mm	£4.65
13-111184	RP series Router 2.0mm	£4.65
13-111185	RP series Router 2.5mm	£4.65
13-111186	RP series Router 3.0mm	£4.65

1/8" Drill Collars

Order the appropriate number of collars at the same time as your B Series drills. These drill collars can be pre-fitted to any of the B Series or MM drills. They are essential when an automatic tool change CNC is used.

Order Code		Price
700-013-3	1/8" Drill Collar	£0.11

Seno Applicators



The Seno applicators offer a safe, clean and efficient alternative to processing in trays. Each applicator contains safe ready to use PCB chemistry. All work at room temperature, the chemistry being completely sealed in a container terminated by a sponge with a valve mechanism which dispenses precisely the right amount on each board. When not in use the sponge is protected by a cap. All applicators are waste free and when exhausted can be disposed of without the need for any special precautions. Each applicator contains safe to use chemistry and there is no need for special precautions when using them. The developers for instance being totally free from Sodium Hydroxide. Each applicator has a shelf life of at least two years. With the exception of etching the complete range of PCB processing sequence can be carried out with the applicators.

SN100 - Photoresist applicator. Easy to apply, very quick drying positive working Photoresist for applying to uncoated laminates.

SN110 - A universal developer applicator which develops all alkaline positive working resists.

SN111 - Soft developer. As SN110 but weaker in strength making it ideal for use with freshly applied resists such as that contained in the SN100.

SN120 - Resist strip applicator, quickly removes all remaining Photoresist from etched boards.

SN130 - De-Ox applicator, removes all oxidation from the etched copper circuit.

SN140 - A flux applicator which applies a protective lacquer to a clean etched circuit, preventing any further oxidation. Lacquer also acts as an excellent solder flux.

Order Code		Price Each 1+	Price Each 3+
600-001	SN100	£6.75	£6.10
600-003	SN110	£6.25	£5.60
600-002	SN111	£6.25	£5.60
600-004	SN120	£6.25	£5.60
600-005	SN130	£6.25	£5.60
600-006	SN140	£6.25	£5.60

Liquid Photoresists

Seno 1000 Photoresist

A professional ready-to-use positive working liquid Photoresist which shows a very strong contrast in developing and has very good adhesion and spreading properties - ideal for the finest circuit board application. The Photoresist can be applied to uncoated PCB laminate by spray, dip and spin coating machines.



Order Code		Price
600-031	Seno 1000 1 ltr	£75.00

A range of safe-to-use PCB chemicals which have been carefully selected not only for their unique processing properties and economical cost but also for their low hazardous content. As with any PCB processing we recommend that during handling and use appropriate protective clothing is used (see page 47). Details on fume extraction are given on page 22.

Photoresist Developers



Liquid Concentrate - Premium Developer

4006V05. The premium developer for processing our many types of Photoresist. Very safe and stable and contains no Sodium Hydroxide. The 1 litre concentrate will make 10-20 litres of working solution depending on the resist. Normal developing time only 30 seconds.

Order Code		Price Each 1+	Price Each 3+
600-010	1 ltr. conc.	£11.50	£10.35

Universal Powder

4007V00. A safe stable powder developer lasting 3-4 weeks in made up form. It develops boards in 30 seconds, with a 30 to 1 safety margin and contains no Sodium Hydroxide. Supplied either as a 50g pack to make 1 litre or a 500g pack to make 10-20 litres depending on the resist.

Order Code		Price Each 1+	Price Each 3+
600-008	50g (1 ltr.)	£1.15	£1.05
600-007	500g (10 ltrs)	£6.95	£6.25

Dry Film Photoresist Developer

A special formulation of developer specifically for negative working dry film Photoresist laminates, (page 23).

Order Code		Price
500-164	1 ltr to make 25 ltrs	£10.95
500-162	5 ltr to make 125 ltrs	£43.60

A complete range of PCB processing chemistry

Etchants

Tin Powder

Stripper

Etchants



Etch-in-the-bag kit

A unique etch-in-the-bag kit containing Ferric Chloride pellets in a dual chamber etching bag. Also included is a measuring tube for hot water, neutraliser for when the solution is exhausted and a storage box. Each kit will etch at least 12 Eurocards 100 x 160mm.

Order Code		Price Each 1+	Price Each 3+
600-017	Etch in Bag	£8.95	£7.95

Ferric Chloride Etchant

Ferric Chloride etchant in either dry pellet form or as a ready-to-use liquid.



Ferric Chloride Pellets

The pellets can be mixed with hot water to make etching solution. Supplied in convenient pellet form which reduces the high carriage charges normally associated with the despatch of liquid etchants.

- 250g - makes 0.5 litre of etching solution
- 500g - makes 1.0 litre of etching solution
- 2.5kg - makes 5.0 litres of etching solution

Order Code		Price Each 1+	Price Each 3+
600-011	250g	£1.70	£1.55
600-012	500g	£3.05	£2.75
600-013	2.5kg	£10.95	£9.85

Ferric Chloride Solution

A special formulation of Ferric Chloride to etch all types of copper circuit boards, as well as other metals such as stainless steel and brass etc. Supplied as full strength 45 Baumé - can be diluted by an additional 30% for use with copper. Available in 5 or 25 litre containers. Some additional shipping costs may apply.

Order Code		Price Each 1+	Price Each 3+
600-015	5 ltrs	£11.50	£10.35
600-016	25 ltrs.	£38.50	£34.75

Fine Etch Crystals



A much cleaner etchant than Ferric Chloride. Slightly longer etching times should be expected and a tank of made up solution will only last 3-4 weeks although the life can be extended by adding a little more powder to the solution. Supplied in powder form to make 5 litres.

Order Code		Price Each 1+	Price Each 3+
600-014	Fine Etch	£17.50	£15.75

Photoresist Strippers

A stripper to remove the Photoresist from the etched circuit.

PC155 - A 1 litre concentrate which makes 5 litres of working solution. Ideal for use in a resist strip tank.



Order Code		Price Each 1+	Price Each 3+
600-019	PC155 Conc.	£11.50	£10.50

Immerse Tin Plating

Seno Tin Powder

A unique stable immerse tin powder that although dissolved in water at 50°C, it actually plates at room temperature. The tin molecules deposited at room temperature are very small making the coating fine, hard and homogenous. Working solution has 6 months shelf life, unmixed powder has unlimited shelf life



Order Code		Price
600-020	90g for 1 Litre	£11.50
600-021	450g for 5 Litres	£34.60

Ferric Chloride Stain Remover

A unique powder which may be utilised in a variety of methods for the removal of Ferric Chloride stains from clothing, PCB tanks, work benches and other affected areas.

Concentration required will depend upon the nature of stain requiring removal but typical concentration in solution is between 100g/200ml and 100g/1000ml of water. The powder may also be used direct on badly affected areas. Supplied as a 1 Kg pack.



Order Code		Price Each 1+	Price Each 3+
600-039	Ferric Chloride Stain Remover	£12.95	£11.65

PC182 Scrub Block

An effective silicone block for cleaning and degreasing copper clad boards.



Order Code		Price Each 1+	Price Each 10+
900-009	Scrub Block	£1.90	£1.60

Scotchbrite Pads

A general purpose scouring pad ideal for cleaning PCBs. Supplied in packs of 10.

Order Code		Price
500-017	Scotchbrite Pads	£6.75

Universal Solvent

A general purpose non-toxic water miscible solvent. Removes unwanted solder flux from PCB, strips Photoresist from etched boards and removes protective seal from Gedakop.



Order Code		Price
600-024	50ml Universal Solvent	£2.70
600-025	1 Ltr Universal Solvent	£16.50

Microtrak PCB Chemicals

A range of PCB processing chemistry specifically for MICROTRAK Pre-coated PCB laminates (page 7).

Microtrak CPD5 Developer

High-resolution, positive-working developing solution suitable for use in a tank or processing tray. CPD5 is less aggressive than some other developers which contain Sodium Hydroxide and allows much greater control over the development process. It is also less affected by exposure to air and so has a much longer shelf life.

The solution is supplied in concentrate form and is mixed 4 parts water to 1 part developer. It should be used at room temperature (18-24°C). Available in 1 litre (makes 5 litres), and 5 litre (makes 25 litres)



Only for use with Microtrak.

Order Code		Price
12-15500	CPD5 1 Ltr	£14.40
12-15501	CPD5 5 Ltrs	£55.30

Microtrak CPS3 Resist Stripper

An alkaline stripping solution supplied as 1 ltr. to make 5 ltrs or 5 ltrs to make 25 ltrs. Solution is used at 55-60°C.

Order Code		Price
12-15061	CPS3 1 Ltr	£21.20
12-15062	CPS3 5 Ltrs	£88.50



1302 Metal Cleaner

1302 is an acid based cleaner for Copper, Brass or Stainless Steel. It is used in 10% - 20% dilution, hot or cold, to prepare metals prior to dry film lamination or immerse tinning. Supplied in 1 litre bottle.



Order Code		Price
500-172-2	1302 Metal Cleaner	£7.50

PCB CHEMICALS

A complete range of PCB processing chemistry

Stain Remover

PC Scrub Block

Microtrak Chemistry

SCREEN PRINTING

High quality, UK manufactured, screen Printing Equipment

A comprehensive range of screen printing consumables for all applications

Bench Top Screen Printing Unit



NEW Bench Top Screen Printing Unit which is ideal for circuit board and non circuit board applications. For circuit boards it can be used to screen print component identents and solder masks with either conventional silk screen stencils or photo-imagable inks. The height adjustment and registration aids also make it ideal for conventional screen printing on a whole host of materials including front panels, nameplates, solder pastes, etc. The Screen Printer allows different screen sizes from 230mm wide to a maximum external frame size of 508mm x 660mm (20" x 26") to be accommodated.

Frames are held by a unique clamp which can be adjusted for frame thicknesses from 46mm to 20mm. This new screen printer has many unique design features. For instance the fitted Silk Screen Frame pivots in a polymer hinge block which eliminates all unwanted 'play' to allow accurate stable screen printing. Stability during printing is further enhanced by height adjustable carriage having a four point single element clamp device mounted on two rigid columns. This height carriage allows the screen to be raised to allow the printing of materials to 75mm thick.

The actual printing bed or Base Board sits on a fine adjustment mechanism to aid registration which allows, from mid-point of adjusters, a 0 -15mm movement in both the X and Y directions as well as angular movement. This stable 19mm solvent resistant Base Board can be removed for easy cleaning or replaced using the four threaded fittings with a customers own base board or printing jig. For long term durability the complete unit is manufactured in a fabricated welded heavy steel construction with a durable powder coat finish.

Approx dimensions: 670mm x 655mm x 70mm
Approx weight: 23kg

Order Code		Price
41-3000	Bench Top Screen Printing Unit	£595.00

Five Star Photostencil Film Developer

For development of Five Star Photostencil Film. The Developer is supplied in powder form and mixed with water to form a working solution. Available in 100 gram or 750g pack sizes.

Order Code		Price
41-112064	Developer 100g	£4.50
41-112064-2	Developer 750g	£26.00

A1 and A2 Screen Printer Units



A1 and A2 screen printing units ideal for printing component ident and solder masks onto printed circuit boards, as well as printing front panels, nameplates etc. The two sizes are available to handle, nominally, A2 and A1 paper sizes. The maximum outside frame dimensions which can be mounted are larger than the screen bed area to allow for the frame thickness and surplus mesh surrounding the working area. The working surfaces are solvent resistant. Different screen sizes can be accommodate by the sliding screen mounting channels. The A1 is supplied with a stand and the A2 can be supplied with or without a stand. The screen frame is of substantial box section construction, epoxy powder coated and fitted with bronze brushed, hardened pivots. To accommodate differing thickness' substrates and adjust 'snap' the screen frame pivots and front stops provide a full 50mm (2") of vertical adjustment. An adjustable height stop limits lift and a counter balance weight can be adjusted to achieve precise balance for the majority of frame types.

Specification

Screen Printing units	A2	A1
Vacuum bed area (mm)	420 x 594	595 x 840
Vacuum bed area (in)	17 x 23	23 x 33
Max outside screen size (mm)	780 x 660	1040 x 725
Max outside screen size (in)	31 x 26	41 x 29
W x D x H (mm)	840 x 1070 x 900	1092 x 1200 x 900
W x D x H (in)	33 x 42 x 36	43 x 47 x 36
Weight (inc. Whisper Vac.Unit)	41kg	50kg

Order Code		Price
41-HMA1NV	A1 Screen Printer complete with stand, no vacuum	£1,610.00
41-HMA2NV	A2 Screen Printer complete with stand, no vacuum	£1,225.00
41-HMA2-1	A2 Bench Top Screen Printer, no vacuum	£1,110.00

Five Star Photostencil Film

Five Star is an indirect stencil film which combines high resolution with a tough and robust stencil, requiring a minimum of spotting out prior to printing. The film is quick and easy to process. Firstly it is exposed to UV light in contact with an artwork. It is then developed by immersion in Photostencil Film Developer, rinsed in warm water and applied wet to the screen mesh. New synthetic meshes should be abraded with Seriprep 101. Again all meshes should be degreased with Universal Mesh Prep prior to application of Five Star.

Order Code		Price
41-112025	104 x 500cm	£108.00
41-112026	104 x 1000cm	£199.00

A comprehensive range of screen printing consumables for all applications



Polyscreen Inks

Polyscreen inks are an ideal medium for printing component legend onto printed circuit boards, as well as for printing front panels, nameplates, schematics etc. The inks combine outstanding resistance to many chemicals and solvents with excellent adhesion to difficult surfaces. They also offer exceptional resistance to heat (including soldering).

Polyscreen inks are supplied in two parts (base and catalyst), packed separately. Catalyst is added to the base component in the ratio of 5 parts base to 1 part catalyst. The ink may be thinned using Polyscreen Thinner & Cleaner (air drying time 1-2 hours). Note that full chemical resistance and adhesion will not be achieved until about 4 days after printing. The drying time can be reduced to 5-8 minutes if the inks are dried using a convection oven operating at 150°C. Equipment can be cleaned down after printing using Thinner/Cleaner or UniversalScreen Wash.

1Kg containers stocked. Ask about non-stock 5Kg quantities.

Order Code		Price
41-PS001	Polyscreen Black Ink 1Kg	£65.80
41-PS021	Polyscreen White Ink 1Kg	£67.65
41-PS041	Polyscreen Yellow Ink 1Kg	£92.85
41-PS386-1	Polyscreen Catalyst 1Kg Tin	£52.80
41-ZE570-1	Polyscreen Thinner/Cleaner (1ltr)	£16.50
41-ZE570	Polyscreen Thinner/Cleaner (5ltr)	£56.95

520 Solder Resist Ink

A new advanced two-part screen printable solder resist with outstanding heat, chemical and solvent resistance. It possesses excellent adhesion to both copper and tin/lead tracks and has the highest possible electrical resistance properties. The base ink is mixed with the 525 catalyst which must be ordered separately. If required it can also be thinned with the OA Thinners. Note that the ink must be stove dried at 120-180°C in either a convection oven or an infra-red dryer to achieve complete curing.

Order Code		Price
41-SR765	520 Solder Resist Green 1kg (without catalyst)	£25.95
41-SR765-2	Catalyst 525 for Solder Resist 520 1KG	£25.95
41-ZE579	Thinner OA 1 Litre	£10.70

Screen Printable Etch Resist Inks

This high definition screen ink is specially formulated for use in the production of printed circuit boards. The ink resists common acid etching solutions such as ferric chloride and persulphate etchants and has good adhesion to all types of copper clad laminate. The resist can be removed in a dilute aqueous solution of Sodium Hydroxide.

Prints will air dry by solvent evaporation overnight or a convection stoving oven can be used. Infra-red conveyerised dryers may also be used. The inks can be thinned with the OA Thinner.

Order Code		Price
41-ER702	Etch Resist Ink 1KG for Screen Printing	£35.35
41-ER702-1	Etch Resist Ink 5KG for Screen Printing	£155.00
41-ZE579	Thinner OA 1 Litre	£10.70

Photo-imageable Soldermask / Idents

These photo-imageable inks are 'blanket' screened onto the PCB before curing in an oven and then exposing with an art-work to UV and processing in normal dry film laminate developer.

5600 - Two Part Solder Mask / Ident Ink

A two part preparation. Hardener is supplied with the pack and the appropriate amount needs to be mixed with the ink prior to use. The shelf life of the prepared ink will then only be 24 hours. Five colours available making it suitable as an ident ink and soldermask.

Order Code		Price
41-2001	Photoimageable Ident Ink White 1Kg	£49.00
41-2002	Photoimageable Ident Ink Black 1Kg	£49.00
41-2003	Photoimageable Ident InkYellow 1Kg	£49.00
41-2004	Photoimageable Matt Green Solder mask ink 5600 1Kg	£49.00
41-2005	Photoimageable Ident Ink Blue 1Kg	£49.00
41-ZE577	Thinner BC 1 Ltr	£6.75

Photo-Imageable Solder Masks

SCREEN PRINTING

A comprehensive range of screen printing consumables for all applications

Seristrip Stencil Remover

For rapid removal of all Stencil films, Seristrip can be used on all types of nylon, polyester and metal screens. It is supplied in powder form in 100g sachets and is mixed with either 10 or 5 litres of water to obtain either 1% or 2% strength solution. Any ink residues on the screen should be removed with Serisolve prior to application of Seristrip Stencil Remover.

Order Code		Price
41-SS-L02	Seristrip Stencil Remover 1 x 100gm	£21.30
41-SS-J41	Seristrip Stencil Remover 5 x 100gm	£99.50

Gelatine Stencil Remover

Gelatine Stencil Remover has been formulated for the rapid and effective removal of Five Star and other gelatine based indirect photostencils. It is a pale yellow liquid containing a proportion of solvents formulated to remove any traces of ink which may remain in the screen. Gelatine Stencil Remover can be used on all types of nylon, polyester and metal screens.

Order Code		Price
41-SS621-1	Gelatine Stencil Remover 5L	£30.65

Universal Screen Wash

A low cost general purpose cleaner used for cleaning inks from screens after printing and for cleaning down equipment. Note that Universal Screen Wash is not suitable for the removal of hardened inks.

Order Code		Price
41-ZT-639	Sericol 1Ltr Screenwash	£8.50
41-ZT-639-1	Seriwash Uni Screenwash (5Ltr.)	£29.00

Actisol Screen Spray

Actisol is a powerful solvent designed to reactivate inks after short breaks in printing runs or whenever dried films of ink clog the screen. It is suitable for use with all types of photo-stencil and solvent based inks.

Order Code		Price
41-AR-G13	Sericol Actisol 511G can	£7.75

Serifix Screen Adhesive

Serifix Screen Mounting Adhesive has been formulated to produce a strong, permanent bond between wood, steel or aluminium screen frames and polyester, nylon or metal screen fabrics. It is extremely easy and economical to use. Besides a long pot life, it has a fast cut-out time permitting a more effective utilisation of stretching equipment. Serifix is composed of two components, base and catalyst, packed separately.

Order Code		Price
41-SF-E06	SF-L93 Serifix2 Adhesive (prt 1) (1Kg)	£19.75

Palette Knife

Used for mixing ink, applying ink to and removing ink from screens. The flexible stainless steel blade, with integral rosewood handle, is rounded to avoid damage to screens.

Order Code		Price
41-112028	Sericol palette knife 6" (152mm)	£14.50

Ink Mixing Cups

Disposable paper cups for mixing inks and solvents. Supplied in packs of 80 cups.

Order Code		Price
41-112090	Sericol Ink mixing cups (pk of 80)	£7.50

Aluminium Squeegees

Aluminium handles with 'Everlast' polyurethane blades which offer excellent abrasion and solvent resistance. Everlast blades are precision cut and hold their edge far longer than natural rubber.

Order Code		Price
41-HEC88-ALM	8" Aluminium hand squeegee (200mm)	£42.50
41-HEC90-ALM	12" Aluminium hand squeegee (300mm)	£59.95

Aluminium Silk Screens



Mega can offer high quality aluminium silk screens to fit a whole host of machines. Each frame has the silk screen mesh applied. Mesh is measured as threads per centimetre, 77 being suitable for the printing of solder masks and 120 for idents and front panel work. Some popular sizes are listed below. All dimensions below are for the outside of the frame. The frames are 38mm wide, the printable area is normally 25mm in on the mesh, ie. 63mm from the outside frame dimension. Alternative size screens and mesh sizes are available upon request.

Order Code		Price
41-112105	Silk Screen 394 x 496mm OD with 77T mesh	£26.00
41-112106	Silk Screen 394 x 496mm OD with 120T mesh	£27.50
41-112102	Silk Screen 623 x 496mm OD with 77T mesh	£33.00
41-112101	Silk Screen 623 x 496mm OD with 120T mesh	£32.00
41-112107	Silk Screen 508 x 762mm OD with 77T mesh	£34.00
41-112108	Silk Screen 508 x 762mm OD with 120T mesh	£36.50



GEDAKOP is a simple system for producing your own single or multi-coloured anodised aluminium panels. The dye is added to the anodised layer of the aluminium and the finished panel sealed in hot water. This 'subsurface' imaging produces permanent scratch and solvent resistant aluminium panels. The **GEDAKOP** aluminium is available from stock in sizes up to 500 x 1000mm and thickness' from 0.2 to 3.00mm. It is ideal for 'one offs' or short production runs. For large quantities the screen printable **GEDALU** is available.

Standard **GEDAKOP** and **GEDALU** has a matt aluminium finish. 'Polished' finish material available on a non-stock basis for approximately 20% extra.

Nine simple steps - all that's needed to produce an anodised aluminium panel!

1. Produce an Artwork

Design the panel using dry transfers or CAD outputting to a pen plotter or laser. Any opaque image on a transparent or translucent carrier will suffice. Our LaserStar film on page 6 produces superb artworks.



2. Cut material

Select a piece of GEDAKOP and cut to size using one of Mega's shears.



3. Expose to U.V.

Place the positive artwork on top of the GEDAKOP panel and expose in a UV unit. For optimum results use a Mega AY vacuum UV unit.



4. Develop the image

Develop the exposed image by placing the panel under running water. Blot the panel with newspaper and dry with a hot air blower or hair dryer.



5. Dye the panel

Apply the appropriate colour dye or dyes to the panel. Remove excess dye and dry with a hot air blower or hair dryer.



6. Strip the Photoresist

Remove the Photoresist from the panel using the stripper.



7. Seal the panel

Place the stripped panel in a Mega Sealing Tank for 45 minutes minimum. This will offer excellent protection sealing the dye within the anodic layer itself.



8. Punch the panel

Add any required holes using a press.



9. Finish

Trim to final size using a Mega Shear and apply radius corners with a Corner Rounder.



SIGNING SYSTEMS

GEDAKOP- Affordable, In House, Anodised Aluminium Panel Production

17 micron Anodic Layer Aluminium

Use Gedakop and Gedalu for:

High quality aluminium Panels

Multi-coloured panels

Rigid panels to 3mm

Permanent panels

Self supporting panels

High quality signs

Gedakop

A convenient way of introducing yourself to Gedakop is by one of the following introductory kit:

GM916 Introductory Kit

Containing one each of the following 160 x 250mm Gedakop sheets 0.5, 1.0 and 1.5mm, 4 colour dyes 30ml each Black 12, Blue 44, Yellow 64, Red 74, 60ml touch-up, 60ml thinner, 500ml stripper (ready to use) 10 applicator pads, 4 sheets 160 x 250mm double sided adhesive sheets and instructions on use.

Order Code		Price
800-042	GM916 Starter Kit	£41.95

Gedakop Anodised Aluminium

GK132 sheet size 320mm x 500mm

Order Code		Price Each Pack	
		1+	3+
800-057	GK132 0.3mm 6 pack	£180.00	£162.00
800-006	GK132 0.5mm 6 pack	£135.00	£121.50
800-007	GK132 0.8mm 4 pack	£105.00	£94.50
800-008	GK132 1.0mm 4 pack	£112.00	£100.80
800-009	GK132 1.5mm 4 pack	£122.00	£109.80
800-010	GK132 2.0mm 2 pack	£75.00	£67.50
800-011	GK132 2.5mm 2 pack	£85.00	£76.50
800-012	GK132 3.0mm 2 pack	£98.00	£88.20

GK166 sheet size 500mm x 660mm

Order Code		Price Each Pack	
		1+	3+
800-013	GK166 0.5mm 4 pack	£183.00	£164.70
800-014	GK166 0.8mm 4 pack	£190.00	£171.00
800-015	GK166 1.0mm 4 pack	£205.00	£184.50
800-016	GK166 1.5mm 4 pack	£232.00	£208.80
800-017	GK166 2.0mm 2 pack	£143.00	£128.70
800-018	GK166 2.5mm 2 pack	£160.00	£144.00
800-019	GK166 3.0mm 2 pack	£179.00	£161.10

Gedakop Anodised Aluminium

GK150 sheet size 500mm x 1000mm

Order Code		Price Each Pack	
		1+	3+
800-020	GK150 0.5mm 4 pack	£237.00	£213.30
800-021	GK150 0.8mm 4 pack	£260.00	£234.00
800-022	GK150 1.0mm 4 pack	£290.00	£261.00
800-023	GK150 1.5mm 4 pack	£330.00	£297.00
800-024	GK150 2.0mm 4 pack	£385.00	£346.50
800-025	GK150 2.5mm 4 pack	£425.00	£382.50
800-026	GK150 3.0mm 4 pack	£490.00	£441.00

Gold Gedakop Anodised Aluminium

GL132 sheet size 320mm x 500mm

Order Code	Gold 320mm x 500mm	Price Each Pack	
		1+	3+
800-027	GL132 0.8mm 4 pack	£124.00	£111.60
800-028	GL132 2.0mm 2 pack	£89.00	£80.10

GL132 sheet size 500mm x 1000mm











Order Code	Gold 500mm x 1000mm	Price Each Pack	
		1+	3+
800-029	GL150 0.8mm 4 pack	£312.00	£280.80
800-030	GL150 2.0mm 4 pack	£465.00	£418.50

Gedakop Consumables**Colour Dyes**

A range of 29 colour dyes are available. Some of the more popular colours are listed below.

Order Code			Price Each Pack	
			1+	3+
800-044	GM100 Black 12	60ml	£9.00	£8.10
800-044-5	GM100 Dark Red 74	60ml	£9.00	£8.10
800-044-1	GM100 Dark Blue 44	60ml	£9.00	£8.10
800-044-2	GM100 Yellow 64	60ml	£9.00	£8.10
800-044-3	GM100 Green 52	60ml	£11.25	£10.15
800-044-4	GM100 Brown 22	60ml	£11.25	£10.15
800-044-6	GM100 Orange 68	60ml	£11.25	£10.15
800-044-7	GM100 Yellow 62	60ml	£9.00	£8.10
800-044-8	GM100 Light Blue 46	60ml	£11.25	£10.15
800-044-9	GM100 Light red 72	60ml	£9.00	£8.10
800-032	GM100 Black 12	500ml	£68.00	£61.20
800-032-0	GM100 Dark Red 74	500ml	£68.00	£61.20
800-032-2	GM100 Dark Blue 44	500ml	£68.00	£61.20
800-032-7	GM100 Yellow 64	500ml	£68.00	£61.20
800-032-4	GM100 Green 52	500ml	£90.00	£81.00
800-032-5	GM100 Green 54	500ml	£68.00	£61.20
800-032-1	GM100 Brown 22	500ml	£90.00	£81.00
800-032-8	GM100 Orange 68	500ml	£90.00	£81.00
800-032-9/1	GM100 Yellow 62	500ml	£68.00	£61.20
800-032-3	GM100 Light Blue 46	500ml	£90.00	£81.00
800-032-9	GM100 Light red 72	500ml	£68.00	£61.20

Gedakop Colours

			
Black 12	Dark Red 74	Dark Blue 44	Yellow 64
			
Green 52	Brown 22	Orange 68	Yellow 62
		<i>Due to the limitations of the printing process accurate colour reproduction can not be guaranteed. When accurate colour reproduction is required refer to a GM108 aluminium colour swatch.</i>	
Light Blue 46	Light Red 72		

GM108 Colour Swatch

An aluminium colour swatch of all 29 colour dyes.

Order Code		Price
800-034	GM108 Colour swatch	£28.50

GM110 Touch Up

60ml of liquid touch up fluid for 'filling in' any unwanted holes in the Photoresist after developing.

Order Code		Price
800-035	GM110 Touch up - 60ml	£6.90

GM120 Thinner

Can be mixed with the dyes to lighten colours, will also strip protective seal from a sealed panel.

Order Code		Price
800-036	GM120 Thinner 60ml	£2.50
800-037	GM120 Thinner 1 Ltr	£30.50

GM130 Stripper

Liquid stripper for removing Gedakop Photoresist, in ready to use or liquid concentrate form.

Order Code	Price
800-038 Gedakop GM130 Stripper 500ml	£5.50
800-039 Gedakop Stripper conc 250ml makes 5 ltrs	£28.50

HB104 Applicator Pads

A pack of 100 pads for applying dye to the developed panel.

Order Code	Price
800-049 HB104 Developing pads (pck of 100)	£8.25

Double Sided Adhesive Sheets

Used to apply a self adhesive backing to Gedakop or Gedalu panels.

Order Code	Price
800-054 Adhesive sheets 320 x 500mm (pck of 10)	£19.55

Stainless Steel Sealing Tanks

A completed Gedakop or Gedalu panel should be immersed in 90°C+ water for at least 45 minutes to seal the dye molecules in the surface of the aluminium, thus protecting the panel from scratching or by chemical attack from solvents etc. To carry out this process a range of sealing tanks are available, each consisting of a thermostatically controlled heated stainless steel inner tank which is thermally lagged and placed in a sturdy wrapper. Each tank is supplied with a number of baskets which hold several panels during sealing.



Order Code	Price
800-047 HB320 Sealing Tank 400 x 500mm	£435.00
800-048 HB324 Spare baskets fo HB320 Tank (pack of 5)	£25.50
800-043 HB660 Sealing Tank 540 x 665mm	£530.00
800-167 HB334 Spare HB660 Baskets (pack of 5)	£28.50

Larger Sealing Tanks available upon request

Sealing Consumables

Gedaseal solution needs to be added to the water used in the sealing tank. It helps seal the panels and prevents excessive ingress of dye into the sealing water. 'Seno' universal solvent is needed to remove the protective seal and clean the finished sealed panel. The solvent can also be used to thin the Gedalu screen printing pastes.

Order Code	Price
800-040-1 Gedaseal 5 Ltrs (Use 25ml/Ltr of water in tank)	£20.50
600-025 SN4010V01 1Ltr Universal Solvent	£16.50

Gedalu - anodised aluminium for screen printing

For larger runs of an identical panel or sign, screen printable Gedalu is strongly recommended. The same high quality aluminium is anodised and chemically protected but no Photoresist is applied. The image is added to the bare aluminium by the screen printing process. The aluminium has been anodised to 17 microns minimum to give excellent printed colour consistency. The sheets are chemically treated to keep it printable for one year after delivery and also to ensure it can be handled without any special precautions.



Like Gedakop - panels are sealed after printing.

Gedalu Aluminium

Order Code	500mm x 1000mm	Price Each Pack
800-064	GU150 0.5mm 10 pack	1+ £210.00 3+ £189.00

Order Code	1000mm x 2000mm	Price Each Pack
800-154	0.8mm 2 pack	1+ £195.00 3+ £175.50
800-155	1.0mm 2 pack	£215.00 £193.50
800-156	1.5mm 2 pack	£245.00 £220.50
800-157	2.0mm 2 pack	£320.00 £288.00
800-158	2.5mm 2 pack	£340.00 £306.00
800-159	3.0mm 2 pack	£390.00 £351.00
800-160	4.0mm 2 pack	£545.00 £490.50

Where possible the 1000 x 2000mm sheets are cut to a smaller size (eg 500 x 1000mm) for ease of shipping. All above material has a matt finish. 'Polished' finish material available on a non-stock basis for extra cost.

A full list of Gedalu products including a Starter Kit and Screen Printing Pastes can be found on our website

SIGNING SYSTEMS

Sealing Tanks

Gedalu

Screen printable anodised aluminium

For multi-colour and volume work

Use
QUICK-MARK®
for:
Self-adhesive
panels, signs,
plastic labels,
Aluminium
front panels

QUICK-MARK®

QUICK-MARK® is the established replacement product for 3M Dynamark. It is designed to produce durable self-adhesive labels, front panels and signs rapidly and efficiently 'in-house'.

The system uses a two-part, dry peel chemical-free process based on coloured polyester Imaging Film sheets and a double-sided adhesive-coated PVC vinyl or aluminium Base Sheets.



- **Metal or plastic**
- **High-tack adhesive**
- **Non-chemical processing**
- **Negative or positive results (you choose!)**
- **No over-lamination required**
- **Durable - up to 5 year external life**
- **Low cost with high quality**
- **Use computer generated originals**
- **Vast colour combinations**

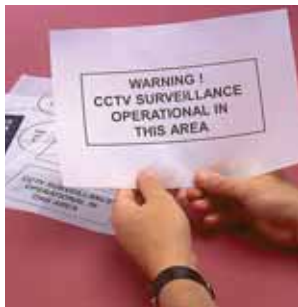

1. Artwork

Any opaque image on a translucent or transparent background will do. An image printed on LaserStar via a laser printer is ideal.



4. Laminate to Base Sheet

Choose either piece of peeled film to laminate to the Base Sheet of your choice. Using the piece of Imaging Film with the emulsion underside makes the label self laminating. Application Fluid helps with the positioning of the film on the adhesive covered Base Sheet.



2. UV Exposure

The Artwork and Imaging Film are exposed together in a UV exposure unit. No dark room required.



5. Trim

Trim the finished QUICK-MARK® label to the required size.



3. Peel

The exposed Imaging Film is placed on the adhesive covered Peeling Board. The two layers of the film are peeled apart. The top layer will be a reversal of the artwork and the bottom layer a positive duplicate.









6. Finished!

The self-adhesive QUICK-MARK® label is now ready to fix to its final location.

Use
QUICK-MARK®
for:
Self-adhesive
panels, signs,
plastic labels,
Aluminium
front panels

QUICK-MARK® Imaging Films 12" x 20" (305mm x 508mm) sheets, 5 per pack

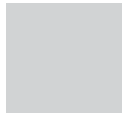









						
Black 12 800-400	Dark Blue 800-401	Red 800-402	Green 800-403	Light Blue 800-404	White 800-406	Grey/Silver 800-407

Due to the limitations of the printing process accurate colour reproduction can not be guaranteed. The translucent nature of the Imaging Films also the final label colour may vary depending on the Base Sheet selected.

QUICK-MARK® Imaging Films 12" x 20" (305mm x 508mm) sheets, 5 per pack

Order Code	Colour	Price	Order Code	Colour	Price
800-400	Black	£52.75	800-404	Light Blue	£52.75
800-401	Dark Blue	£52.75	800-406	White	£52.75
800-402	Red	£52.75	800-407	Grey/Silver	£52.75
800-403	Green	£52.75			

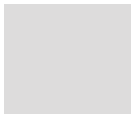
QUICK-MARK® Base Sheets 12" x 20" (305mm x 508mm) sheets, 5 per pack

						
White 800-500	Yellow 800-501	Silver 800-502	Transparent 800-503	Red 800-511	Gold 800-512	Orange 800-513
				<p>Due to the limitations of the printing process accurate colour reproduction can not be guaranteed.</p> <p>For accurate colour representation refer to 800-306 colour swatch.</p>		
Beige 800-514	Blue 800-515	Aluminium 800-504	Gold Aluminium 800-506			

QUICK-MARK® Base Sheets 12" x 20" (305mm x 508mm) sheets, 5 per pack

Order Code	Colour	Price	Order Code	Colour	Price
800-500	White	£29.95	800-502	Silver	£29.95
800-501	Yellow	£29.95	800-512	Gold (Plastic)	£28.95
800-511	Red	£30.95	800-503	Transparent	£29.95
800-513	Orange	£30.95	800-504	Aluminium	£30.95
800-514	Beige	£30.95	800-506	Gold Anodised Aluminium (Usable 11" x 20")	£88.50
800-515	Blue	£30.95			

**QUICK-MARK® Over Laminating Film
pack of 5 Sheets 12" x 20"**

Order Code	Colour	Price
800-600	Transparent	£24.25
800-601	Matt	£24.25
800-605	Lexan Polycarbonate	£24.25

**QUICK-MARK® Premium Adhesive
Base Sheet - pack of 5 Sheets 12" x 20"**

Order Code	Colour	Price
800-800	White	£45.25
800-804	Aluminium	£45.25

**QUICK-MARK®
Consumable Accessories**

Order Code	Colour	Price
800-300	Peeling Board 12" x 20"	£12.25
800-301	Peeling Board 10" x 12"	£8.50
800-305	Processing Tray	£10.50
800-143	PA1 Applicator	£1.95
800-049	HB104 Pads (100) to put over edge of PA1	£8.50
800-308	QUICK-MARK® Application Fluid 500ml makes 1 litre	£8.50
800-350	QUICK-MARK® Starter Kits	£40.95
800-306	QUICK-MARK® Swatch	£10.45

A FULL SPECIFICATION SHEET DETAILING PEEL STRENGTHS, CHEMICAL RESISTANCE,
UV RESISTANCE, SERVICE TEMPERATURE ETC. IS AVAILABLE ON REQUEST.

SIGNING SYSTEMS

Quick-Laser™ self-adhesive coloured laser printable polyesters

Quick-Laser™

Quick-Laser™ is a range of strong, durable self-adhesive polyester sheets. Supplied as A4 or die cut they can be printed on via any ordinary office laser printer. They are ideal for serial number labelling, various signing applications and front panel production. As well as the A4 sheets, which can be over-laminated for extra

protection, there are over 50 die cut label variants available. The material comes in a semi-clear colour, six further solid colours and a 'void' anti-tamper label stock.

White labels can be used with colour laser printers to produce full colour labels.



Quick-Laser™ - Laser printable polyester labels, front panels and signs.

- Print from any Laser Printer.
- Standard temperature range -40° – +150°C
- Strong Acrylic Adhesive
- A4 sheets, plain or die cut
- Silver, White, Yellow, Blue and Green available
- Void-anti-tamper labels available
- Over-lamination possible on A4 plain sheets

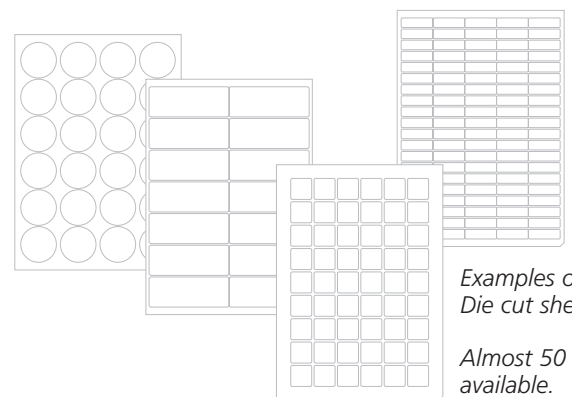

Examples of Die cut sheets.

Almost 50 available.

Over-lamination

Quick-Laser™ plain A4 sheets can be given extra protection by over-laminating with either Polyester or Polycarbonate. Application fluid is sprayed on the printed sheet to aid lamination.

Quick-Laser™ Specifications

Part number A4 plain	Part number A4 die cut	Type	Colour	Label + Adhesive	Liner	Temperature	Material	Adhesive
8L1-SA4	8L1-SD*	Type 1 Silver	Silver matt	0.09mm	0.08mm	-40°C - +150°C	Polyester	Modified Acrylic
8L2-WA4	8L2-WD*	Type 2 White	White	0.09mm	0.09mm	-40°C - +150°C	Polyester	Modified Acrylic
8L3-BA4 blue 8L3-GA4 green 8L3-RA4 red 8L3-YA4 yellow	8L3-BD* blue 8L3-GD* green 8L3-RD* red 8L3-YD* yellow	Type 3 Coloured	Red, blue, yellow, green	0.09mm	0.09mm	-40°C - +150°C	Polyester	Modified Acrylic
8L4-TA4	8L4-TD*	Type 4 Transparent	Transparent	0.09mm	0.8mm	-40°C - +150°C	Polyester	Modified Acrylic
8L5-KA5	N/A	Type 5 Rainbow pack	20 x Silver, 5 each white, trans., red, blue, yellow, green			-40°C - +150°C	Polyester	Modified Acrylic
8L6-VA4	8L6-VD*	Type 6 VOID	White	0.08mm	0.08mm	-40°C - +150°C	Polyester	Modified Acrylic

Over Lamination

Part number A4 sheets	Type	Colour	Label + Adhesive	Liner	Temperature	Material	Adhesive
8LL-7742	7742 Polyester Matt	Transparent Matt	0.05mm	0.06mm	-40°C - +125°C	Polyester	Modified Acrylic with UV stabiliser.
8LL-7741	7741 Polyester gloss	Transparent Gloss	0.05mm	0.06mm	-40°C - +125°C	Polyester	Modified Acrylic with UV stabiliser.
8LL-7737	7737 Polycarbonate	Transparent Polycarbonate	0.1mm	0.06mm	-40°C - +125°C	Polycarbonate	Modified Acrylic with UV stabiliser.

A4 PLAIN SHEETS	Sheets Per Pack	Colour	Part No A4 plain	Price 1 - 2	Price 3 - 4 (10% less)	Price 5 - 9 (15% less)	Price 10+ (20% less)
Type 1 Standard Silver	50	Silver matt	8L1-SA4	£68.25	£61.45	£58.00	£54.60
Type 2 Standard White	50	White	8L2-WA4	£68.25	£61.45	£58.00	£54.60
Type 3	50	Blue	8L3-BA4	£86.25	£77.65	£73.30	£69.00
Standard Coloured		Green	8L3-GA4	£86.25	£77.65	£73.30	£69.00
		Red	8L3-RA4	£86.25	£77.65	£73.30	£69.00
		Yellow	8L3-YA4	£84.50	£76.95	£72.70	£68.40
Type 4 Transparent	50	Transparent	8L4-TA4	£84.00	£75.60	£71.40	£67.20
Type 5 Rainbow pack	50	20 x Silver, 5 x white, yellow, blue, green, red, transparent	8L5-KA5	£78.75	£70.90	£66.95	£63.00
Type 6 VOID	50	White	8L6-VA4	£99.75	£89.80	£84.80	£79.80
7742 Over-laminate Matt	50	Transparent Matt	8LL-7742	£57.75	£51.95	£49.00	£46.20
7741 Over-laminate Gloss	50	Transparent Gloss	8LL-7741	£57.75	£51.95	£49.00	£46.20
7737 Over-laminate Matt	50	Polycarbonate Matt	8LL-7737	£99.75	£89.80	£84.80	£79.80

A4 DIE CUT	Sheets Per Pack	Colour	Part No A4 plain	Price 1 - 2	Price 3 - 4 (10% less)	Price 5 - 9 (15% less)	Price 10+ (20% less)
Type 1 Silver	50	Silver Matt	8L1-SD*	£125.00	£112.50	£106.25	£100.00
Type 2 White	50	White	8L2-WD*	£125.00	£112.50	£106.25	£100.00
Type 3	50	Blue	8L3-BD*	£163.00	£146.70	£138.55	£130.40
Standard Coloured		Green	8L3-GD*	£163.00	£146.70	£138.55	£130.40
		Red	8L3-RD*	£163.00	£146.70	£138.55	£130.40
		Yellow	8L3-YD*	£147.00	£132.30	£124.95	£117.60
Type 4 Transparent	50	Transparent	8L4-TD	£153.00	£137.70	£130.05	£122.40
Type 6 VOID	50	White	8L6-VD*	£179.00	£161.10	£152.15	£143.20

Die cut sheet part numbers - Replace the * with the die cut sheet part number e.g. 8L1-SD* becomes 8L1-SD01 for sheet design 1 and 8L1-D20 for sheet design 20. Die cut designs are detailed on separate Quick-Laser™ literature.

SIGNING SYSTEMS

Quick-Laser™
self-adhesive
coloured laser
printable
polyesters

Sublimation Printing System

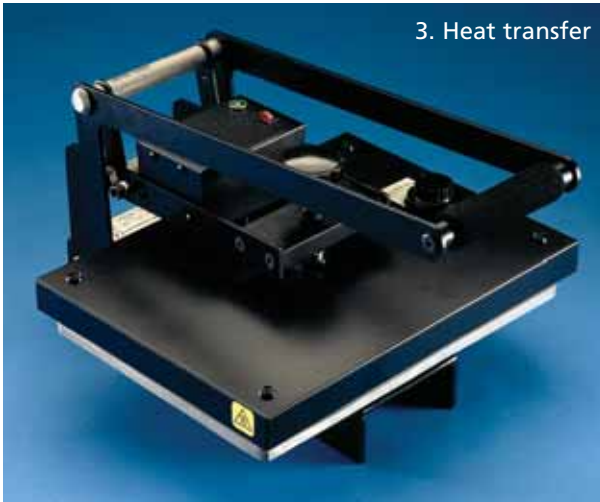
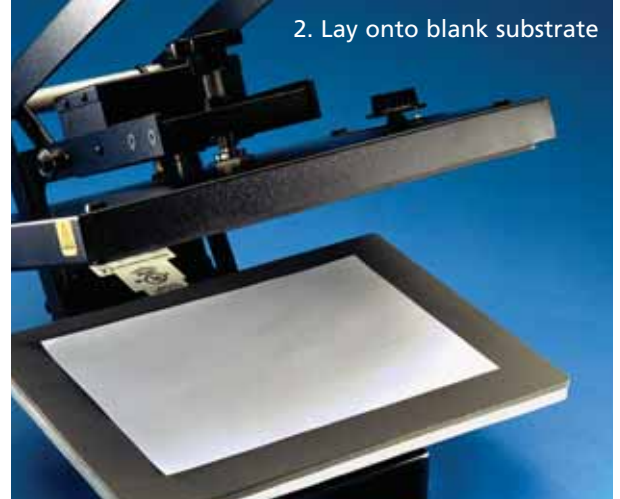

This simple cost effective system is ideal for the in-house manufacture of industrial signs, nameplates, labels and general signage on various substrates, in full colour. It is also ideal for promotional items and educational use for printing mouse mats, coasters, CNC laminates, vacuum forming plastics, Foamex and textiles.

Ideal for 'one-off' to small production quantities. The key to the process are special inks and substrates that enable your printed design to be heat transferred into the surface of the substrate material. With the image in the surface of the substrate - no over-lamination is necessary.

Right are samples of what can be achieved with our Sublimation System.



Contact us for a full colour brochure and price list together with our CD Video presentation, so that you see how user-friendly our system really is.

Or we can organise a demonstration for you to see and use first-hand.



Metal Etched Panels in Brass and Stainless

The same principal for the etching of Printed Circuit Boards can be employed to etch metal panels for sign making. Depending on panel size required and anticipated throughput a whole range of equipment can be selected. The following represents a possible kit to produce etched panels in brass or stainless steel in sizes up to 300mm x 500mm, 3mm thick.

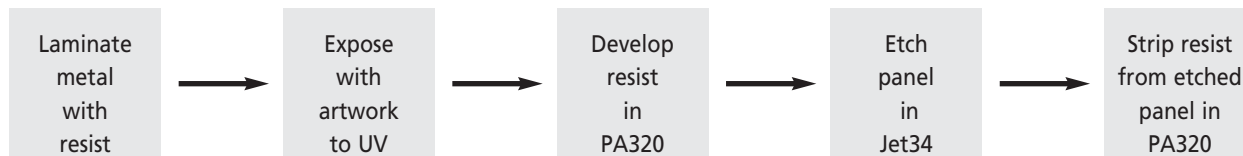

A Complete Metal Etching Kit



Sheet Dry Film Laminator A3



AY321 U.V. Exposure Unit



Jet 34d Spray Processing Machine



PA320 Processor (for developing and stripping)

Kit consists of:

- | | | | |
|--------------|----------------------------------------------|---------------|---------------------------------------------------|
| 1 x 300-145 | AY321 Vacuum Exposure Unit | 1 x 600-016 | 25 litres Ferric Chloride Solution |
| 1 x 27-22808 | A3 Sheet Laminator | 2 x 600-019 | 1 litres Photoresist stripper (concentrated) |
| 1 x 500-046 | PA320 Develop/Wash/Strip Processor | 1 x 500-025 | 12" wide roll x 30m Dry Film Photoresist (1 roll) |
| 1 x 35-16046 | Jet 34d Single Sided Spray Etcher | 1 x 500-172-1 | Acid Metal Cleaner 1 Litre Concentrate |
| 1 x 500-164 | 1 litre conc. Dry Film Photoresist Developer | | |

Order Code		Price
500-090	Metal Etching System	£3,200.00

A saving of almost £500.00 on individual items

As well as the above complete kit other relevant items can be found in the following sections of the catalogue:
 Artwork Aids - pages 2-3 • UV Exposure Units - pages 8-9 • Spray & Conveyorised Processing Units - page 17
 Laminators & Dry Film - page 23 • Shears & Corner Rounder - page 25-26 • Developers & Etchants - pages 31-32

Quikmask Photosensitive Mask Processor For Sandblasting

The popular method of producing etched or sandblasted designs on glass is to use a photo-imaged mask. A computer design is transferred to the mask film, which is then applied to the glass before sandblasting. The Quikmask system have been especially designed to produce in-house ultra-violet sensitive film mask simply, quickly and to a consistently high standard. The mask is then applied to the object to be sandblasted e.g. Glass, Marble etc., using a low tack spray adhesive allowing the original artwork pattern to be created on the object.



Quikmask Stencil Kit • No pressurised water needed • Low cost • Easy to use • User friendly procedure

Low cost processing for sandblast masks to 6" x 9" (152mm x 228mm).

Kit contains:

- 1 x LV202E Exposure Unit with inbuilt timer
- 1 x Quikmask A3 Low voltage Light Box
- 1 x Quikmask A3 Processing Tray
- 1 x Quikmask Film Dryer Cabinet
- 1 x set of Quikmask Consumables

(Sandblaster should be ordered seperately, see our web site)



UV Exposure Unit



Developing Quikmask film



Drying the Quikmask film

Order Code		Price
500-720	Quikmask Stencil Kit	£695.00
500-613-1	Quikmask Pro Red 75 micron film 21 x 30cm (10 pk)	£35.00
500-613-2	Quikmask Pro Red 75 micron film 21 x 30cm (25 pk)	£82.50
500-613-3	Quikmask Pro Red 75 micron film 21 x 30cm (50 pk)	£165.00
500-613-4	Quikmask Pro Red 75 micron film 0.31m x 7.5m	£112.00
500-613-5	Quikmask Pro Red 75 micron film 0.31m x 30m	£448.00
500-613-6	Quikmask Pro Red 75 micron film 0.31m x 3m	£95.00
500-613-7	Quikmask Pro Red 75 micron film 1.32m x 10m	£605.00
500-606	T-Fix Adhesive Spray	£10.95

Quikmask Stencil Kit Processing Sequence

1. Artwork production

A computer generated artwork is printed via an Epson inkjet printer on Jetstar or via a Laser printer on LaserStar.

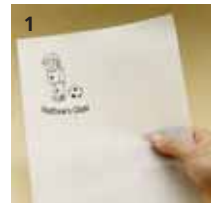

2. U.V. Exposure

The artwork and a piece of Quikmask film is exposed to U.V. light in the LV202-E exposure unit



3. Developing

The artwork is placed on the special low voltage illuminated light box. The angled processing tray with water reservoir is placed on top of the light box. The exposed Quikmask film is then developed with a sponge and water. With the original artwork under the tray accurate reproduction is easy.



4. Drying

The quickmask film is then placed in the drying cabinet.



5. Spraying with Adhesive

When completely dry the film is sprayed with an adhesive for positioning on the glass.



6. Mask positioned on the glass

With the mask in position on the glass, the top part of the film, the clear protective overlay, is removed



7. Masking Tape

The edges of the glass are then protected from inadvertent sandblasting with masking tape.



8. Sandblasting

The glass is then blasted with a sandblaster from Mega which is sold seperately to the film processing kit.



9. Finished Glass

After blasting the unwanted Quikmask film is removed with water and the finished glass cleaned.





Coverall

A lightweight coverall which is both extremely durable and tough. It combines the best qualities of film, fabric and paper, resulting in a garment which is both protective and comfortable to wear. This coverall suit is ideal for use in both clean and dirty areas, or where short term splash protection is required. The coverall is zip front fastening and is available in sizes small, medium, large and extra large.

Order Code		Price
10-SL001-1	Coverall (small)	£11.95
10-SL001-2	Coverall (med)	£11.95
10-SL001-3	Coverall (lge)	£11.95
10-SL001-4	Coverall (ext lge)	£11.95



Laboratory Coat

Protective coat made from durable material for use in laboratory, workshop, warehouse or factory.

Very comfortable to wear and protects against dust, dirt and chemical splashes. Features include collar, stud-fastened front and straight-cut cuffs. Sizes small, medium and large.

Order Code		Price
10-SL400-2	Lab coat (med)	£8.95
10-SL400-3	Lab coat (lge)	£8.95

Rubber Gloves



Black seamless rubber gauntlets conforming to BS1651. Natural rubber to provide maximum durability and give excellent protection against various chemicals. 17" long, medium weight.

Order Code		Price
10-71022/1	Size 8	£8.30
10-71022/2	Size 9	£8.30
10-71022/3	Size 10	£8.30
10-71022/4	Size 11	£8.30

Suretouch Vinyl Gloves



Disposable vinyl ambidextrous seamless gloves with high anti-tear properties. These gloves offer high sensitivity and good resistance to various chemicals, inks etc. Box of 100 gloves in four sizes.

Order Code		Price
10-V770N-1	Small	£7.95
10-V770N-2	Medium	£7.95
10-V770N-3	Large	£7.95
10-V770N-4	Extra Large	£7.95



Power Safety Cut-out (RCD)

A RCD power breaker device which constantly monitors the balance of current flow and will automatically switch off the current in the event of even a minute leakage to earth, thus greatly reducing the risk of fatal shock. British made to BS4293 and BS1363, type tested to BS7071:1992. We recommend the use of this unit with all our PCB processing tanks.

Order Code		Price
161053	RCD Device	£16.50

Squall Eyeshield

Single clear polycarbonate lens and frame offering all round protection with indirect ventilation. Kitemarked BS2092 Grade 2 impact.



Order Code		Price
900-015	Squall Eyeshield	£3.15

SUNDRIES AND ACCESSORIES

Trays

Syphon

PCB Racks

Spares

Processing Dishes



Rigid polystyrene trays suitable for processing copy or reversal films, or for developing or tinning PCBs. The trays, which have a spout to facilitate emptying, are available in three sizes.

Order Code		Price
45-3806	410mm x 500mm	£15.00
45-3807	305mm x 410mm	£10.50
45-3808	254mm x 305mm	£5.80

PCB Storage Rack

Polypropylene holders for storage, transportation and protection of PCBs during manufacture and assembly. The racks are resistant to most liquids used in production processes and withstand temperatures of up to 120°C. Each rack holds 25 boards of varying sizes.

Size 1 - D210 x W274 x H83mm,

Size 2 - D355 x W265 x H127mm.

Maximum board thickness: 2.5mm

Money and greater rigidity over the above vacuum formed alternatives.

Rack size 400mm x 77mm x 25mm.

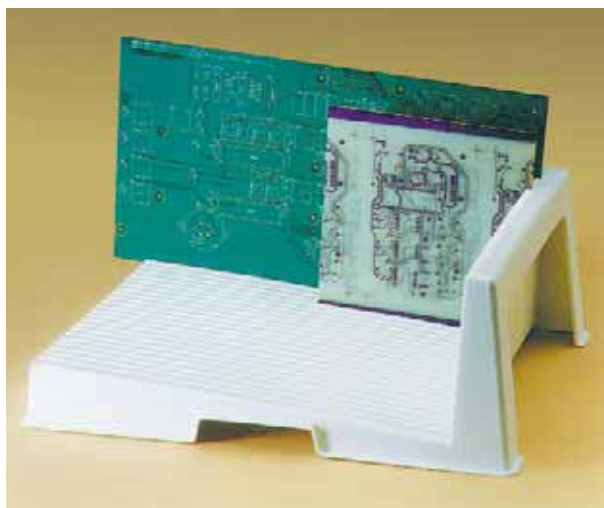

Order Code		Price
53-22013	Storage Rack Size 1	£5.10
53-22014	Storage Rack Size 2	£7.30

ABC Copper Plating Line Spares

Order Code		Price
250064	Anode for Plating Line 10" x 12"	£17.50
250056	Anode bag for Plating Line 10" x 12"	£5.30
250061	Anode for Plating Line 18" x 12"	£33.75
250057	Anode Bag for Plating Line 18" x 12"	£6.00
250058	Anode Hook for Plating Line Anodes	£ 4.65

PC 180 Syphon

For emptying tanks up to 350mm deep, (as supplied, with PA range.)

Order Code		Price Each Pack
		1+ 10+
191023	PC180 Syphon	£4.50 £4.05

Universal PCB Holder

The Universal PCB Holder represents a low budget board holder for up to 20 boards. Manufactured from polypropylene it is impervious to almost all PCB manufacturing chemicals and can be washed clean. Virtually indestructible this rack offers excellent value for money and greater rigidity over the above vacuum formed alternatives. Rack size 400mm x 77mm x 25mm.



Order Code		Price
53-22015	Universal PCB Holder	£4.90

PC190 Tray Polypropylene

Easily handled size 13" x 9" x 2" with carrying lips. May be used for some chemical processes e.g. PC163 immerse tin.

Order Code		Price
900-011	PC190 Tray	£2.25

Spares - UV Exposure Units

Order Code		Price
170011	UV tube 8W/05 12"	£3.99
170012	UV tube 15W/05 18"	£4.99
170002	UV tube 20W/05 24"	£6.05
170004	UV tube 40W/05 24"	£9.95
171001	Choke - 13W	£4.35
171003	Choke - 30W	£4.35
171004	Choke - 40W	£4.35
172016	Starters - series	£0.60

Guillotine Blades

Order Code		Price
27-18050	Guillotine Blades - for Model 45 18"	£80.00
900-043	Guillotine Blades - for DM525 25"	£85.00

PCB Processing Tanks/Lines

Order Code		Price
900-039	Lid & Basket 10" x 12"	£6.50
900-041	Lid & Basket 12" x 18"	£8.15
160032	Heater 500w	£29.95
160056	Thermostat	£11.50
291000	Bubble Bar Assembly	£6.25

Minimum Order

Due to the cost of processing small orders with have a minimum order of £15.

Quotations

Any written quotation issued will, unless otherwise stipulated, exclude carriage and VAT and will be firm for 30 days only.

Ordering - Approved Accounts

Orders are accepted by post, telephone or fax and normally despatched within 24 hours. All UK Colleges, Schools, and other Government bodies have automatic account facilities and orders will be accepted for immediate despatch.

Ordering - Non Account Customers

Orders can only be processed for non-account customers if full payment has been received. Orders placed by post with full payment enclosed (i.e. goods total plus carriage/packing and VAT) will be despatched forthwith. Alternatively we can accept MasterCard, Visa or Switch for immediate despatch.

Pro-forma Invoices

A pro-forma will be issued upon customer request. Goods will then be despatched on receipt of cleared funds in full.

To Open an Account

Any request to open a credit account will be considered from any organisation which does not enjoy automatic account facilities. Any such request should be accompanied by two trade references and bankers details. The account opening process normally takes up to two weeks. Payment in advance, in full, is normally also required for the first order.

Export Orders - Letter of Credit

If it is agreed a Letter of Credit is the best form of payment for an order the LC should be irrevocable, drawn on, or guaranteed by a UK bank and all charges pertaining to the LC should be to the purchasers account. An administration charge is levied for all LCs.

Prices

Prices shown are in pounds sterling. They are ex-works and exclusive of packing, carriage and VAT. We must reserve the right to amend prices without prior notice.

Carriage and Packing

The following can be used to estimate the carriage costs:
Post small packet £2.90
Parceline next day delivery up to 25Kg £6.50
Carriers of wet chemistry and parcels over 25Kg, at cost.

Certain pieces of equipment may require an additional specialist packing charge.

Speed of Despatch

All orders are normally despatched the same day of receipt. Should any item be out of stock then every effort will be made to despatch the order as soon as possible.

Next Day delivery

All items can be despatched for next day delivery, if required, please request this service when placing your order.

Collection from premises

By prior arrangement customers can collect goods from our Linton warehouse. 24 hours notice is normally required.

Return, loss and damage in transit

Goods properly delivered by us will not be accepted back unless we are advised beforehand and have agreed to accept them. Such goods returned as not wanted or incorrectly ordered must be sent back carriage paid and will be subject to a minimum 10% handling charge. Claims for damaged goods, non-receipt or shortages must be advised in writing within seven days of invoice date. Goods delivered by a carrier and signed for when delivered as 'received in good condition' will be unable to be returned as 'damaged in transit'.

Warranties and liability

All products manufactured by Mega have a 12 month warranty*. Any item found to be defective through faulty materials or workmanship will be replaced, repaired or at our discretion the purchase price refunded. Mega's liability will always be accountable to a maximum of the purchase price of any such product.

Improvement to specification

In line with our policy of continuous product improvement we reserve the right to make design or product alterations or to discontinue any item without prior notice.

Settlement terms

Settlement terms on all accounts are net cash and are due for payment within 30 days of the date of invoice. In the event of default Mega reserves the right to charge interest at two percent above the current Lloyds Bank Plc base rate at monthly intervals on the overdue portion of the account and immediately suspend or cancel any contract in respect of any undelivered goods.

**AT ALL TIMES GOODS SUPPLIED BY US
WILL REMAIN THE PROPERTY OF MEGA
UNTIL FULL PAYMENT IN THE FORM OF
CLEARED FUNDS HAS BEEN RECEIVED.**

*If sold within the EU.

Visit our Website at
www.megauk.com

Servicing Industry and Education



QUICK-MARK®



Hardware

CNC Production Systems

UV Exposure Units

Through Hole Plating

Front Panel Production

Label Production

PCB Prototyping Systems

PCB Processing Equipment

PCB Chemicals

PCB Laminates

Lightboxes

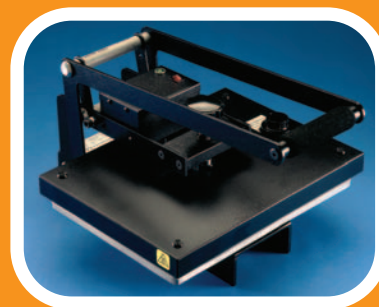

SUBLIMATION



MEGA

Electronics

MEGA HOUSE
GRIP INDUSTRIAL ESTATE
LINTON, CAMBRIDGE CB1 6NR

TEL: 01223 893900
FAX: 01223 893894

Email: sales@megauk.com

Web: www.megauk.com