

# HOLLOW SHAFT ACTUATORS

FHA Series

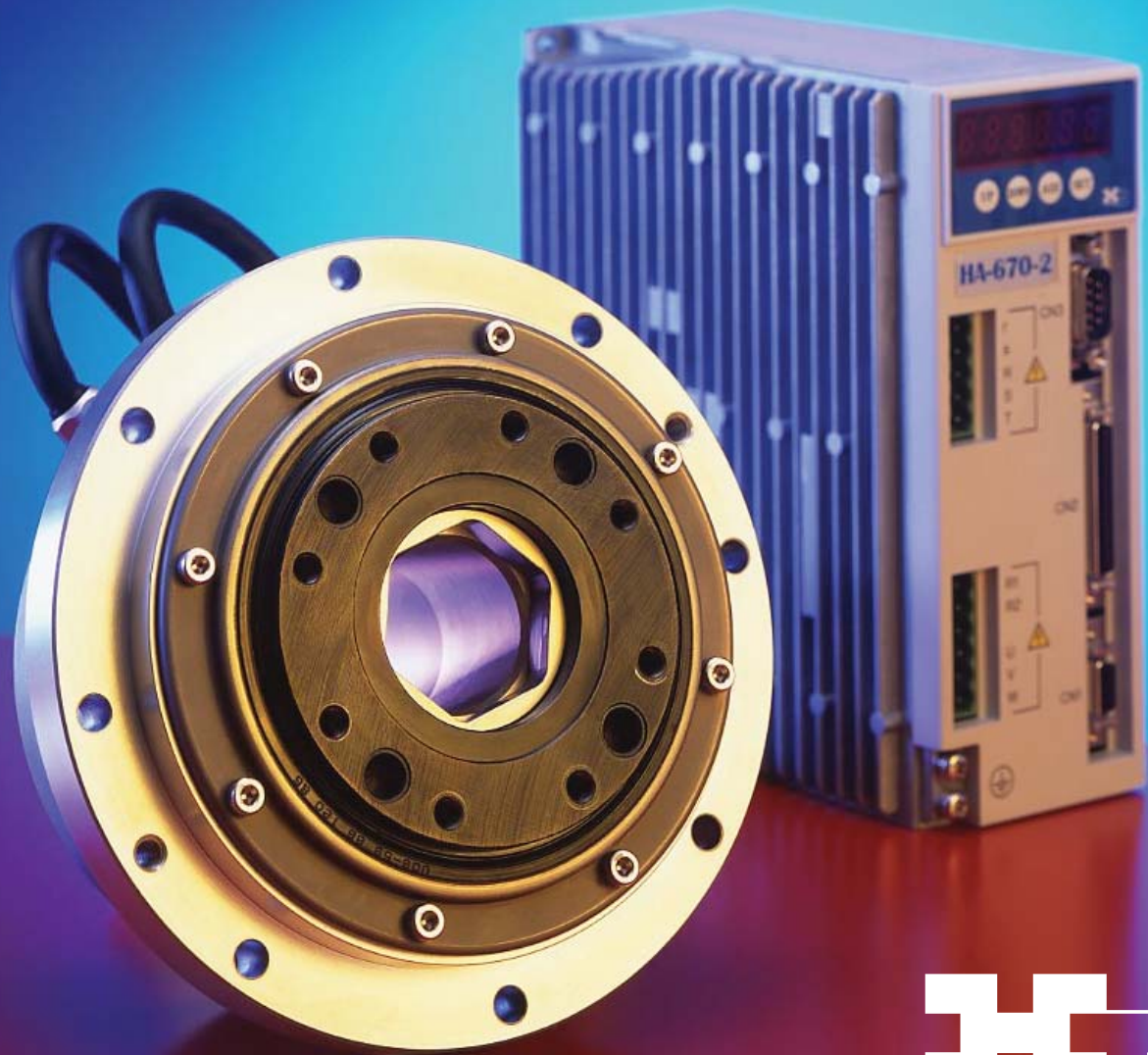

harmonic drive gearing

Precision Gearing & Motion Control



## CONTENTS

	Safety Guide	1
<b>Chapter 1</b>	Overview of the FHA-C series	3
1-1	Features	3
1-2	Ordering information	4
1-3	Combinations with drivers	4
1-4	Specifications of FHA-C actuators	5
1-4-1	For incremental positioning system	5
1-4-2	For absolute positioning system	6
1-5	External dimensions of FHA-C actuators	7
1-5-1	For incremental positioning system	7
1-5-2	For absolute positioning system	9
1-6	Mechanical accuracy of FHA-C actuators	11
1-7	One-way positioning accuracy	12
1-8	Encoder resolution	12
1-9	Torsional Stiffness of actuators	12
1-9-1	Moment stiffness	12
1-9-2	Torsional stiffness	13
1-10	Rotary direction	14
1-11	Impact resistance	14
1-12	Vibration resistance	14
1-13	Torque-speed characteristics	14
1-14	Cable specifications	17
1-15	Signal Waveforms	18
<b>Chapter 2</b>	Selection Guidelines	19
2-1	Allowable load inertia	19
2-2	Variable load inertia	19
2-3	Verifying loads	20
2-4	Duty cycles	24
2-4-1	Actuator speed	24
2-4-2	Load inertia	24
2-4-3	Load torque	24
2-4-4	Acceleration time and deceleration time	25
2-4-5	Calculating equivalent duty	26
2-4-6	Effective torque and average speed	29
2-4-7	Permissible overloaded time	30
2-4-8	Regeneration energy	30
<b>Chapter 3</b>	Installing the FHA actuator	31
3-1	Receiving Inspection	31
3-2	Notice on handling	32
3-3	Location and installation	32
3-3-1	Environment of location	32
3-3-2	Installation	33
<b>Chapter 4</b>	Options	34
4-1	AC100V power supply	34
4-2	Brake for motor	35
4-2-1	Specifications for incremental encoder system	35
4-2-2	Brake leads	35
4-3	Cable-end connectors	36
4-4	Clamp for output	36
4-5	5 meter cables	37
4-6	Cable outlets from back face	37
4-7	Rotary position sensor set	38
4-7-1	Specifications	38
4-7-2	Adjusting procedure for sensor locations	39
4-7-3	Movable range for each limit switch	40
4-8	Extension cables	41
4-9	Connectors	41
Appendix 1	Unit conversion	42
Appendix 2	Moment of inertia/Calculation of mass and moment of inertia	44
2	Inertia of cylinder	46
	Warranty and terms	47

# FHA-C Series

## AC SERVO ACTUATOR MANUAL

- Thank you very much for your purchasing our FHA-C series servo actuator.
- Be sure to use sufficient safety measures when installing and operating the equipment so as to prevent an accident resulting in a serious physical injury damaged by a malfunction or improper operation.
- Product specifications are subject to change without notice for improvement purposes.
- Keep this manual in a convenient location and refer to it whenever necessary in operating or maintaining the units.
- The end user of the actuator should have a copy of this manual.

## SAFETY GUIDE

- For actuators, motors, control units and drivers manufactured by Harmonic Drive LLC
- Read this manual thoroughly before designing the application, installation, maintenance or inspection of the actuator.
- **WARNING:** Indicates a potentially hazardous situation, which, if not avoided, could result in death or serious personal injury.
- **CAUTION:** Indicates a potentially hazardous situation, which, if not avoided, may result in minor or moderate personal injury and/or damage to the equipment.

## LIMITATION OF APPLICATIONS:

The equipment listed in this document may not be used for the following applications:

- Space equipment • Automobile, automotive parts
  - Aircraft, aeronautic equipment • Amusement equipment, sport equipment, game machines
  - Nuclear equipment • Machine or devices acting directly on the human body
  - Household apparatus •
  - Instruments or devices to transport or carry people
  - Vacuum equipment •
  - Apparatus or devices used in special environments
- Please consult us, if you intend to use our products in one of the areas mentioned above.

**Safety measures are essential to prevent accidents resulting in death, injury or damage of the equipment due to malfunction or faulty operation.**

## Precautions When Using An Actuator and/or Driver

### CAUTIONS FOR ACTUATORS IN APPLICATION DESIGN

The actuator must only be used indoors, where the following conditions are provided:

- Ambient temperature: 0°C to 40°C
- Ambient humidity: 20% to 80%RH (Non-condensating)
- Vibration: Max 24.5 m/S<sup>2</sup>
- No contamination by water, oil or foreign matters
- No corrosive, inflammable or explosive gas

Follow exactly the instructions in the relating manuals to install the actuator in the equipment.

- Ensure exact alignment of motor shaft center and corresponding center in the application.
- Failure to observe this caution may lead to vibration, resulting in damage of output elements.

## CAUTIONS FOR ACTUATORS IN OPERATIONS

### Do not exceed the allowable torque of the actuator.

- Be aware, that if a load arm attached to the output hits by accident an obstacle, the output shaft may become uncontrollable.

### Never connect cables directly to a power supply socket.

- An actuator must not be operated without a corresponding driver.
- Failure to observe this caution may lead to injury, fire or damage of the actuator.

### Protect the actuator from impact and shocks

- Do not use a hammer to position the actuator during installation
- Failure to observe this caution could damage the encoder and may cause uncontrollable operation.
- Avoid handling of the actuator by its cables.
- Failure to observe this caution may damage the wiring, causing uncontrollable or faulty operation.

## CAUTIONS FOR DRIVERS IN APPLICATION DESIGN

### Always use drivers under the following conditions:

- Mount in a vertical position keeping sufficient distance to other devices to let heat generated by the driver radiate freely.
- Ambient temperature: 0° to 50°
- Ambient humidity: less than 95% RH (Non condensation)
- No contamination by water, oil or foreign matters
- No corrosive, inflammable or explosive gas Use sufficient noise suppressing means and safe grounding.
- Keep signal and power leads separated.
- Keep leads as short as possible.
- Ground actuator and driver at one single point, minimum ground resistance class: D (less than 100 ohms)
- Do not use a power line filter in the motor circuit. Pay attention to negative torque by inverse load.  
–Inverse load may cause damages of drivers.
- Please consult our sales office, if you intent to apply products for inverse load. Use a fast-response type ground-fault detector designed for PWM inverters.
- Do not use a time-delay-type ground-fault detector.

## CAUTIONS FOR DRIVERS IN OPERATIONS

### Never change wiring while power is active:

- Make sure of power non-active before servicing the products.
- Failure to observe this caution may result in electric shock or personal injury.  
Do not touch terminals or inspect products at least 5 minutes after turning OFF power.
- Otherwise residual electric charges may result in electric shock.
- Make installation of products not easy to touch their inner electric components. Do not make a voltage resistance test.
- Failure to observe this caution may result in damage of the control unit.
- Please consult our sales office, if you intent to make a voltage resistance test.
- Do not operate control units by means of power ON/OFF switching.
- Start/stop operation should be performed via input signals.
- Failure to observe this caution may result in deterioration of electronic parts.

## DISPOSAL OF AN ACTUATOR, A MOTOR, A CONTROL UNIT AND/OR THEIR PARTS

- All products or parts have to be disposed of as industrial waste.
- Since the case or the box of drivers have a material indication, classify parts and dispose them separately.

## Chapter 1

### Overview of the FHA-C series

FHA series servo actuators provide high torque and high accuracy rotary motion. The actuators are comprised of Harmonic drive® component from No. 17 to No.40 for precise motion control and a super-flat AC servomotors.

The first feature of the FHA series actuators is their super-flat shape. The body width is less than half of our previous models. The second feature is a large through-hole in the center of the shaft, through which electric cables, air pipes, and even laser beams can be passed to supply power and signals to moving parts.

The HA-655 series and th HA-675 series are dedicated servo drivers for the FHA-C series actuator to control its position and speed. The small and intelligent driver controls the FHA-C series actuators with great accuracy and reliability.

FHA-C series actuators play an important role for driving various factory automation (FA) equipment; such as robot joints, alignment mechanisms for semiconductor and LCD equipment, ATC of machine tools, printing machine roller, etc.

### 1-1 Features

- **Super-flat configuration**

FHA-C series actuator is the union of Harmonic drive® gearing for precise motion control with a super-flat AC servomotor. The dimension from the coupling flange face to the actuator end is less than half the size of our previous models. The total thickness including the output flange is 30% flatter than our previous models. The compact size allows smaller machines to be designed.

- **Through-hole shaft**

The center through-hole shaft allows for the insertion of electric cables, air pipes, or laser beams through the actuator to supply power and signals to moving parts. This feature will simplify the driven machine.

- **High torque**

FHA-C series actuator outputs have a much higher torque per volume than direct drive motors owing to Harmonic drive® gearing. FHA-C series actuators have a higher rating than our previous models.

- **High positioning accuracy**

FHA-C series actuators provide superior positioning accuracy. The FHA-25C/-32C/-40C -160 actuators achieve positioning accuracy of 30 arc seconds (exceptionally, FHA-17C-160: 40arc seconds) as well as an encoder resolution of 1,600,000 pulses per output revolution..

- **High torsion stiffness**

FHA-C series actuators provide from 30% to 100% greater torsion stiffness when compared with the previous series. This feature shortens positioning time and decreases the vibration during servo-lock stop.

- **Optional absolute encoder**

FHA-C series actuators allows to select an encoder system from two kinds of encoders for detecting a position: the one is an incremental encoder for general applications and the other is an absolute encoder (optional) for keeping its current position data all the time, even in power failure. The complex cable for the incremental encoder saves its wires resulted in increased reliability and simplified wiring.

In this document, **INC** is attached for the descriptions for the incremental system only, and **ABS** is for the absolute system only.

## 1-2 Ordering Information for the FHA actuators

Model number of FHA-C series actuators are as follows:

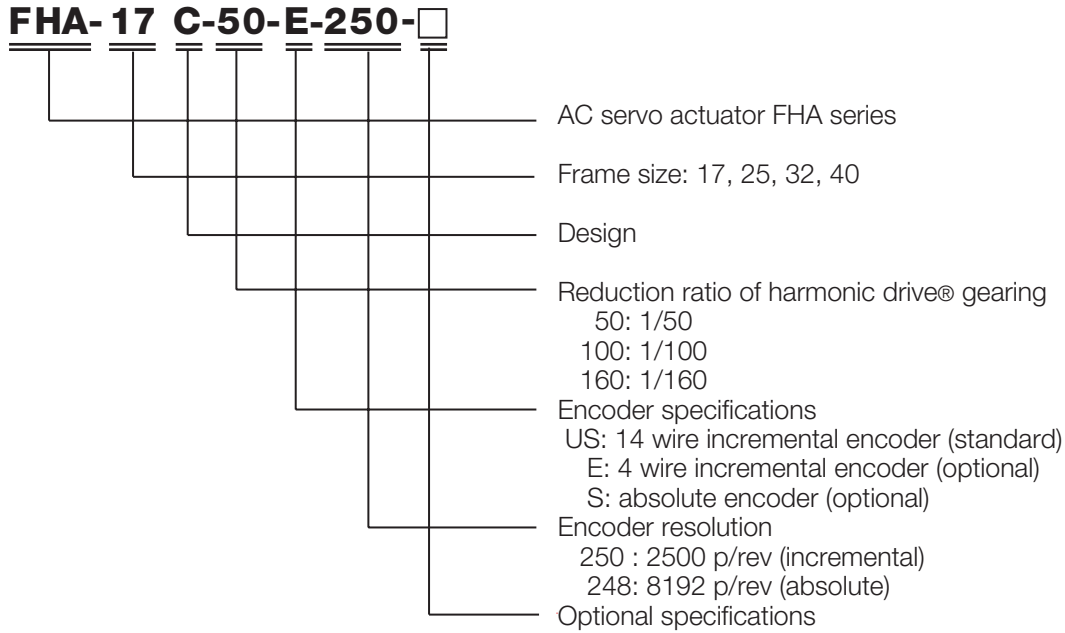

Details of the optional specifications are as follows:

Optional spec.	Details	Symbol
AC100V power supply	available for FHA-17C, -25C, -32C only	A
Brake for motor	for holding motor shaft	B
Position sensors	origin and end limits	L
Cable-end connectors	for motor cable (IP-20) & for encoder cable (IP-40)	C
Cable outlet on back face	from back bracket face	K
Protection	equivalent to IP-67(technical arrangement is required)	W
Clamp for output	by built-in hydraulic mechanism with position sensors	D
5 meter cables	5m for each motor cable and encoder cable	F5
24V	available for FHA-17C only	E

Note 1: For more details, refer to chapter 4.

Note 2: For requirement of two or more optional items, please contact to Harmonic Drive System, Inc. for availability and delivery date.

## 1-3 Combinations with drivers

Two series of HA-655 and HA-675 drivers are available for use with FHA-C actuators dealing with their nominal current and encoder systems. The correct actuator / driver combinations are as follows:

Volt	Incremental System <b>INC</b>				Absolute System <b>ABS</b>			
	FHA-17C -xx-US250	FHA-25C -xx-US250	FHA-32C -zz-US250	FHA-40C -XX-US250	FHA-17C -xx-S248	FHA-25C -xx-S248	FHA-32C -xx-S248	FHA-40C -xx-S248
200V	HA-655-2-200	HA-655-2-200	HA-655-4-200	HA-655-4-200	HA-655-2A-200	HA-655-2A-200	HA-655-4A-200	HA-655-4A-200
	HA-675-2-200	HA-675-2-200	HA-675-4-200	HA-675-4-200	HA-675-2A-200	HA-675-2A-200	HA-675-4A-200	HA-675-4A-200
100V	HA-655-2-100	HA-655-4-100	HA-655-4-100	-	HA-655-2A-100	HA-655-4A-100	HA-655-4A-100	-
	HA-675-2-100	HA-675-4-100	HA-675-4-100	-	HA-675-2A-100	HA-675-4A-100	HA-675-4A-100	-

## 1-4 Specifications of FHA-C actuators

### 1-4-1 INCREMENTAL SYSTEM **INC**

Specifications of FHA-C series actuators with the **14 Wire Incremental Encoder** are as follows:

Model			FHA-17C-xx-US250			FHA-25C-xx-US250			FHA-32C-xx-US250			FHA-40C-xx-US250		
			50	100	160	50	100	160	50	100	160	50	100	160
Maximum Torque	Note 2	N•m	39	57	64	150	230	260	281	398	453	500	690	820
Maximum Speed		r/min	96	48	27	90	45	28	80	40	25	70	35	22
Torque Constant <sup>1)</sup>	200V	N•m/A	21	42	67	22	45	72	27	54	86	31	64	102
	100V	N•m/A	11	21	33	11	2.2	36	13	27	43	15	32	51
Maximum Current Note 2	200V	A	2.1	1.6	1.1	7.3	5.6	4.0	11.4	8.0	5.9	17.3	11.8	9.0
	100V	A	4.2	3.2	2.2	15	11	8.0	23	16	12	35	24	18
EMF Voltage Constant	200V	V/(r/min)	2.3	4.7	7.5	2.5	5.1	8.1	3.0	5.9	9.5	3.6	7.2	11.4
	100V	V/(r/min)	1.2	2.4	3.8	1.3	2.6	4.1	1.5	3.0	4.8	1.8	3.6	5.7
Phase Resistance	200V	(20°C)	7.9			2.6			1.0			0.73		
	100V	(20°C)	2.0			0.65			0.25			0.18		
Phase Inductance	200V	mH	6.0			2.6			1.3			1.5		
	100V	mH	1.5			0.65			0.33			0.38		
Inertia of Actuator	(GD <sup>2</sup> /4)	kg•m <sup>2</sup>	0.17	0.67	1.7	0.81	3.2	8.3	1.8	7.1	18.1	4.9	19.5	50
	(J)	kgf•cm•s <sup>2</sup>	1.7	6.9	17	8.3	33	85	18	72	185	50	200	510
Reduction Ratio			1:50	1:100	1:60	1:50	1:100	1:60	1:50	1:100	1:60	1:50	1:100	1:60
Allowable Radial Load		kN	2.9			4.9			9.5			14.7		
Allowable Axial Load		kN	9.8			14.7			24.5			39.2		
Allowable Torsional Moment		N•m	188			370			530			690		
Moment stiffness		N•m/rad	220x10 <sup>3</sup>			490x10 <sup>3</sup>			790x10 <sup>3</sup>			1400x10 <sup>3</sup>		
One-way Positioning Accuracy		arc-sec	60	40	40	40	30	30	40	30	30	40	30	30
Motor encoder			2500 pulse/rev.											
Quad encoder -resolution	Note 4	Pulse/rev	500,000	1,000,000	1,600,000	500,000	1,000,000	1,600,000	500,000	1,000,000	1,600,000	500,000	1,000,000	1,600,000
Mass		Kg	2.5			4.0			6.5			12		
Enclosure			Totally enclosed, self-cooling (equivalent to IP44)											
Environmental conditions			Service / Storage temperature : 0~40°C / -20 ~ 60°C Service / storage humidity : 20~80%RH (no condensation) Vibration / impact resistance : 24.5m/s <sup>2</sup> (freq:10-400Hz) , shock resistance 294 m/s <sup>2</sup> No dust, no metal powder, no corrosive gas, no inflammable gas, no oil mist; install in room, no direct sunlight Altitude: less than 1,000 meters above sea level											
Motor insulation			Insulation resistance: 100MΩ or more (by DC500V insulation tester) Withstanding voltage: AC1500V / 1 minute Insulation class: F											
Orientation			All position											

Note 1: The table shows output values of actuators.

Note 2: Values for saturated temperature under the conditions that the actuator is driven by an appropriate HA-655 or HA-675 driver.

Note 3: Quad encoder resolutions are obtained by [motor encoder resolution] x 4 x [reduction ratio]



## 1-4-2 Absolute System

Specifications of FHA-C series actuators with an **Absolute Encoder** are as follows:

Model	FHA-17C-xx-US248			FHA-25C-xx-US248			FHA-32C-xx-US248			FHA-40C-xx-US248				
	50	100	160	50	100	160	50	100	160	50	100	160		
Maximum Torque		N•m	39	57	64	150	230	260	281	398	453	500	690	820
Maximum Speed		r/min	96	48	27	90	45	28	80	40	25	70	35	22
Torque Constant <sup>1)</sup>	200V	N•m/A	21	42	67	22	45	72	27	54	86	31	64	102
	100V	N•m/A	11	21	33	11	2.2	36	13	27	43	15	32	51
Maximum Current Note 2	200V	A	2.1	1.6	1.1	7.3	5.6	4.0	11.4	8.0	5.9	17.3	11.8	9.0
	100V	A	4.2	3.2	2.2	15	11	8.0	23	16	12	35	24	18
EMF Voltage Constant	200V	V/(r/min)	2.3	4.7	7.5	2.5	5.1	8.1	3.0	5.9	9.5	3.6	7.2	11.4
	100V	V/(r/min)	1.2	2.4	3.8	1.3	2.6	4.1	1.5	3.0	4.8	1.8	3.6	5.7
Phase Resistance	200V	(20°C)	7.9			2.6			1.0			0.73		
	100V	(20°C)	2.0			0.65			0.25			0.18		
Phase Inductance	200V	mH	6.0			2.6			1.3			1.5		
	100V	mH	1.5			0.65			0.33			0.38		
Inertia of Actuator	(GD <sup>2</sup> /4)	kg•m <sup>2</sup>	0.2	0.7	1.9	0.8	3.4	8.6	1.8	7.3	18.1	5.0	19.8	50.7
	(J)	kgf•cm•s <sup>2</sup>	1.7	7.5	19.2	8.6	34.2	87.6	18.5	74.2	185	50.5	202	517
Reduction Ratio			1:50	1:100	1:60	1:50	1:100	1:60	1:50	1:100	1:60	1:50	1:100	1:60
Allowable Radial Load		kN	2.9			4.9			9.5			14.7		
Allowable Axial Load		kN	9.8			14.7			24.5			39.2		
Allowable Torsional Moment		N•m	188			370			530			690		
Moment stiffness		N•m/rad	220x10 <sup>3</sup>			490x10 <sup>3</sup>			790x10 <sup>3</sup>			1400x10 <sup>3</sup>		
One-way Positioning Accuracy		arc-sec	60	40	40	40	30	30	40	30	30	40	30	30
Motor encoder			2500 pulse/rev.											
Quad encoder -resolution	Note 4	Pulse/rev	409,600	819,200	1,310,720	409,600	819,200	1,310,720	409,600	819,200	1,310,720	409,600	819,200	1,310,720
Mass		Kg	2.9			4.5			7.1			13		
Enclosure			Totally enclosed, self-cooling (equivalent to IP44)											
Environmental conditions			Service / Storage temperature : 0~40°C / -20 ~ 60°C Service / storage humidity : 20~80%RH (no condensation) Vibration / impact resistance : 24.5m/s <sup>2</sup> (freq:10-400Hz) , shock resistance 294 m/s <sup>2</sup> No dust, no metal powder, no corrosive gas, no inflammable gas, no oil mist; install in room, no direct sunlight Altitude: less than 1,000 meters above sea level											
Motor insulation			Insulation resistance: 100MΩ or more (by DC500V insulation tester) Withstanding voltage: AC1500V / 1 minute Insulation class: F											
Orientation			All position											

Note 1: The table shows output values of actuators.

Note 2: Values for saturated temperature under the conditions that the actuator is driven by an appropriate HA-655 or HA-675 driver.

Note 3: Quad encoder resolutions are obtained by [motor encoder resolution] x 4 x [reduction ratio]

## 1-5 External dimensions of FHA actuators

### 1-5-1 Incremental Systems INC

The external drawings are shown as follows:

#### • FHA-17C-xx-US250 INC

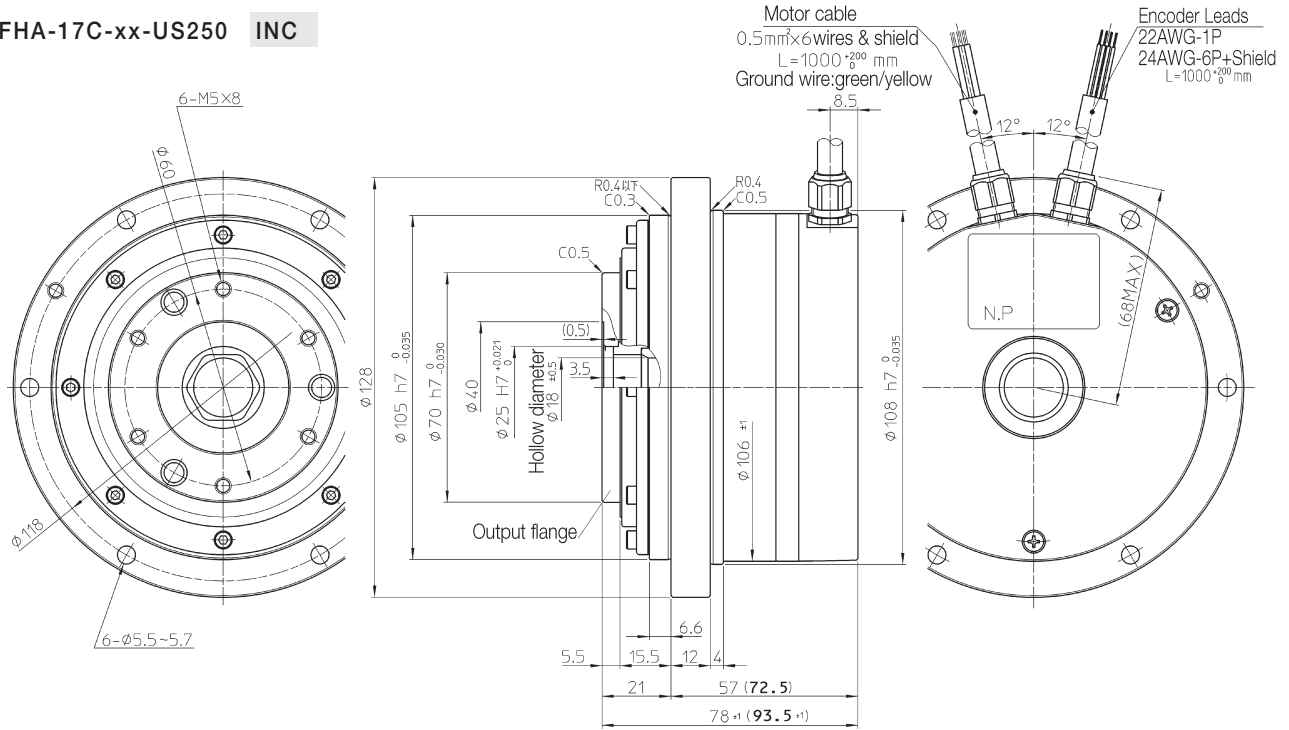

#### • FHA-25C-xx-US250 INC

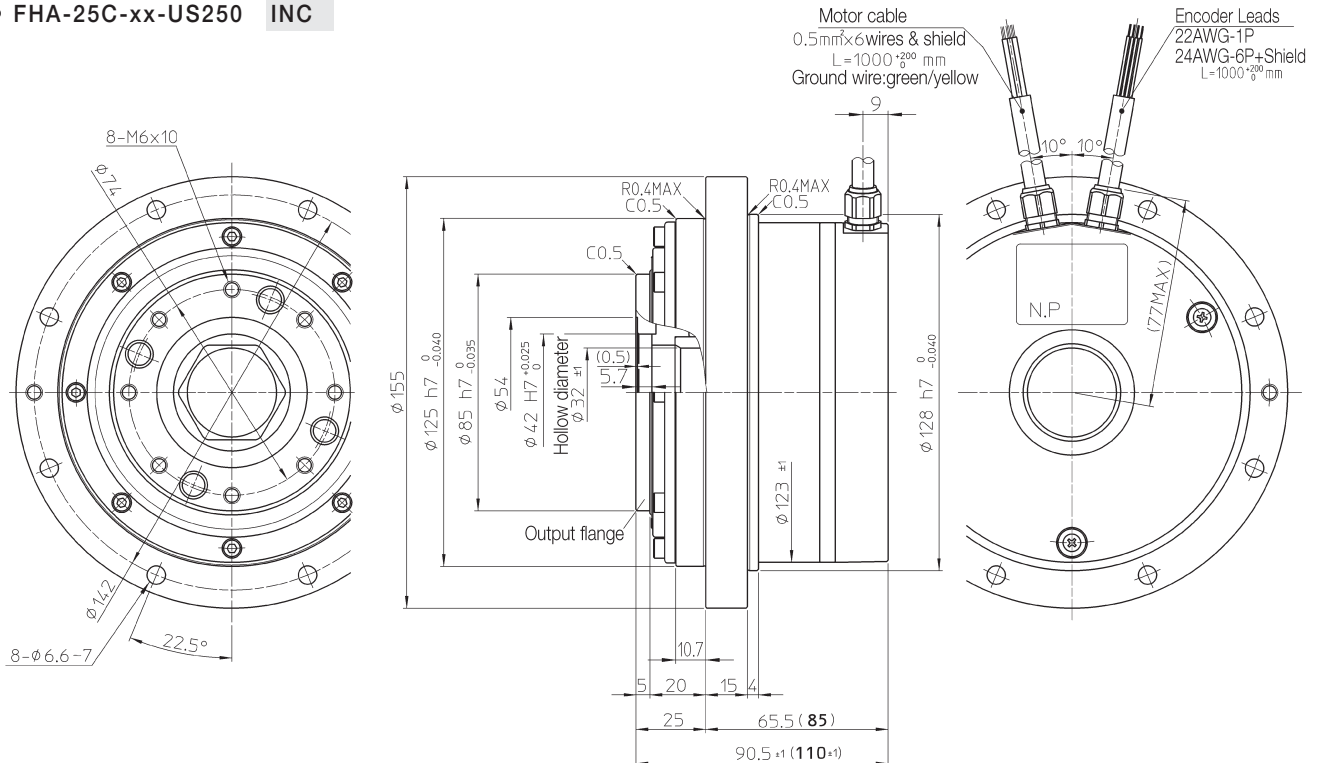

Note 1: The parenthesized dimensions are applied for the actuators with a brake option.  
 Note 2: For detail dimensions, make sure of them referring our drawings for shipping.



## 1-5-2 Absolute Systems ABS

The external drawings are shown as follows:

### • FHA-17C-xx-S248 ABS

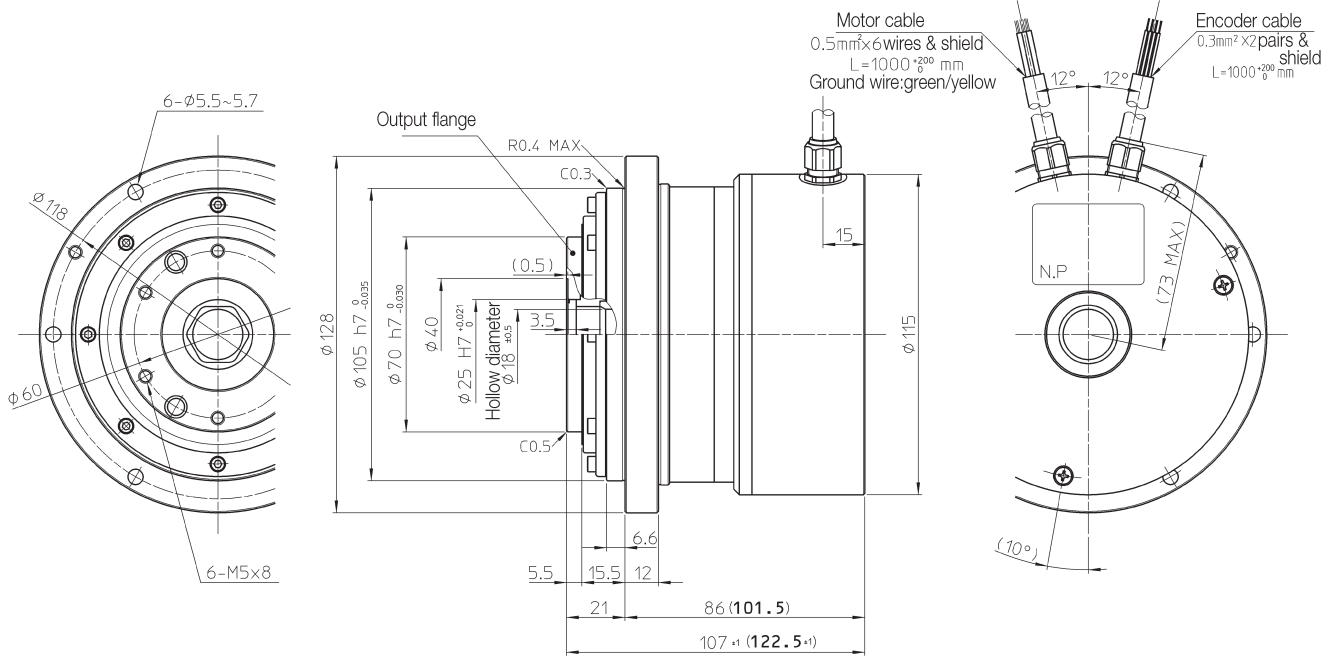

### • FHA-25C-xx-S248 ABS

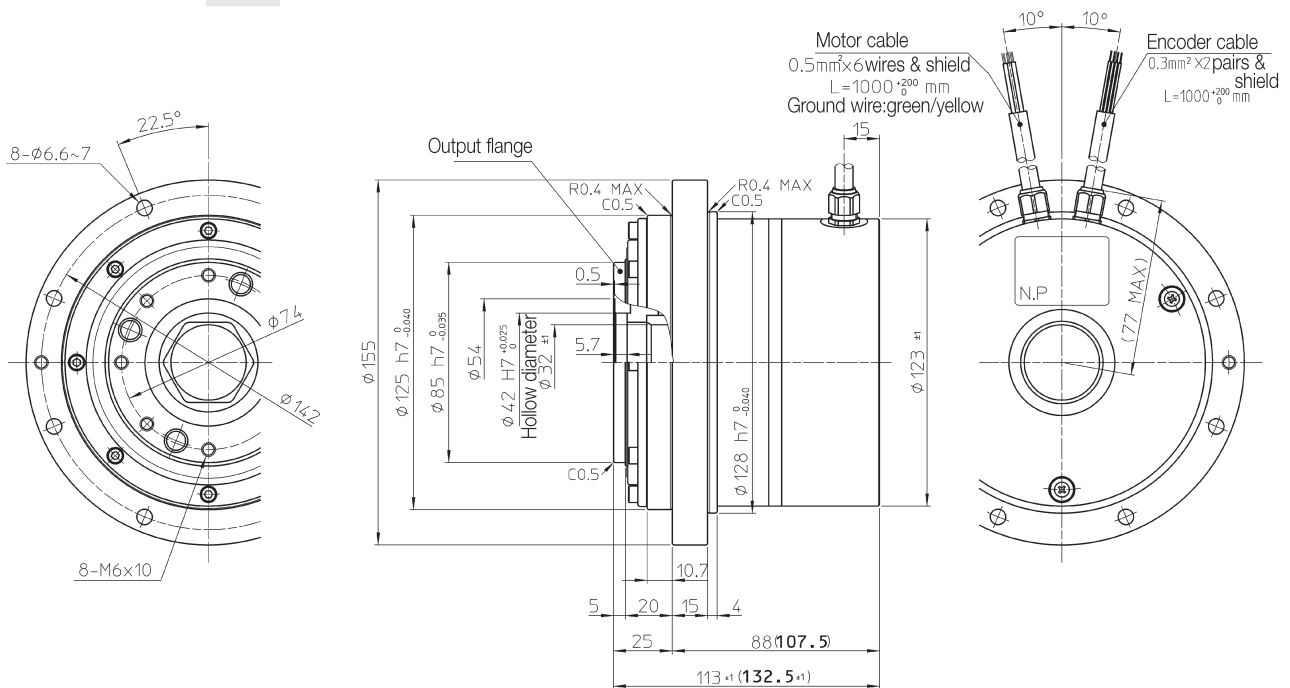

Note 1: The parenthesized dimensions are applied for the actuators with a brake option.  
Note 2: For detail dimensions, make sure of them referring our drawings for shipping.

Unit: mm (third angle projection)

• FHA-32C-xx-S248 ABS

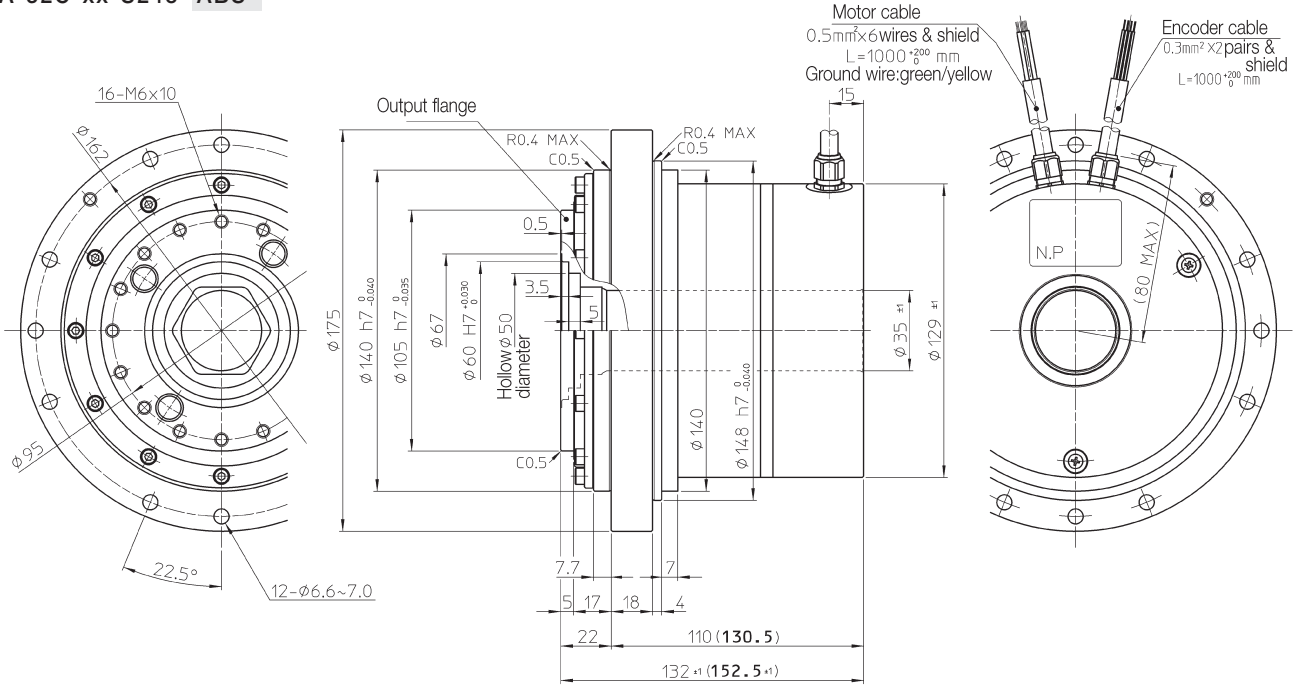

• FHA-40C-xx-S248 ABS

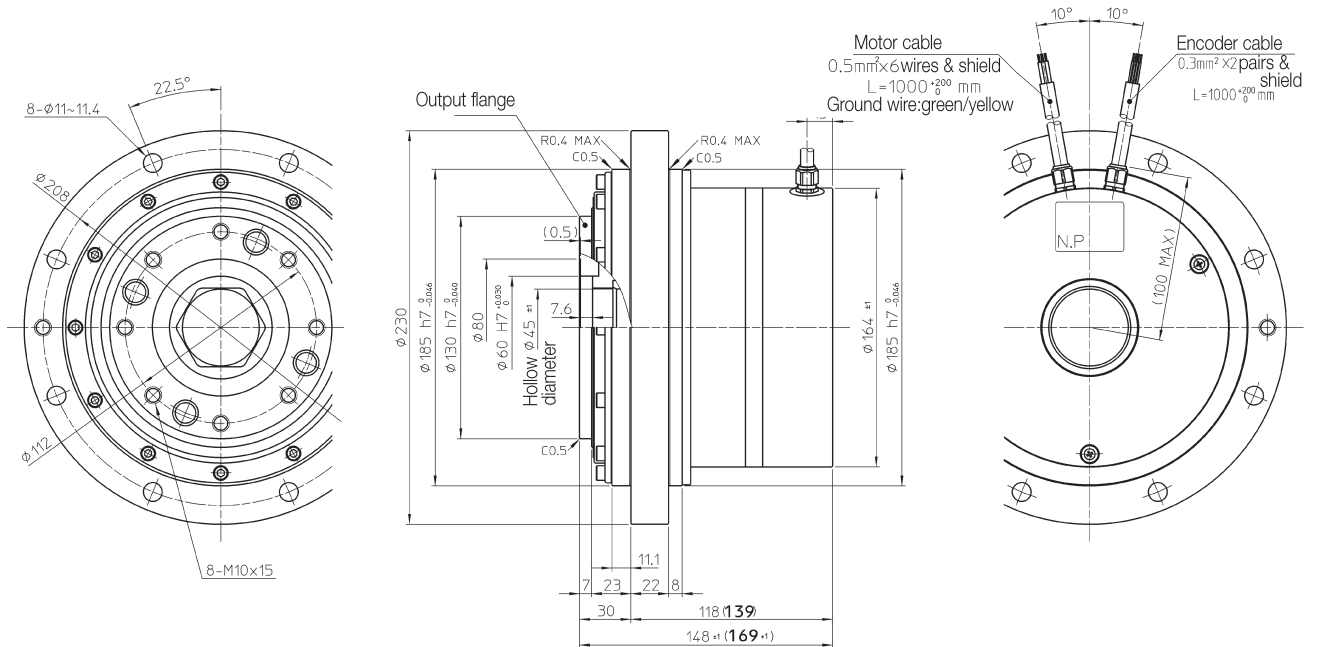

Note 1: The parenthesized dimensions are applied for the actuators with a brake option.  
 Note 2: For detail dimensions, make sure of them referring our drawings for shipping.

## 1-6 Mechanical accuracy of FHA actuators

The machining accuracy of the output flange and the mounting flange are indicated in the table below.

Machined accuracy of the output flange unit: mm

Machined parts	FHA-17C	FHA-25C	FHA-32C	FHA-40C
1. Axial run-out of output flange	0.010	0.012	0.012	0.014
2. Radial run-out of output flange	0.010	0.012	0.012	0.014
3. Parallelism between output flange and mounting flange	0.040	0.050	0.050	0.060
4. Concentricity between output flange to fitting face	0.040	0.050	0.050	0.060

Note: All values are T.I.R (Total Indicator Reading).

The measuring for the values are as follows:

- **Axial run-out of output flange**

The indicator (1) on a fixed portion measures the axial run-out (T.I.R.) of perimeter of output flange for one revolution.

- **Radial run-out of output flange**

The indicator (2) on a fixed portion measures the radial run-out (T.I.R.) of perimeter of output flange for one revolution.

- **Parallelism between output flange and mounting flange**

The indicator (3) on the output flange measures the axial run-out (T.I.R.) of each perimeter of both sides of the fixing flange for one revolution.

- **Concentricity between output flange to fitting face**

The indicator (4) on the output flange measures the radial run-out (T.I.R.) of each surface of both fitting face (drive-end side and opposite side) for one revolution.

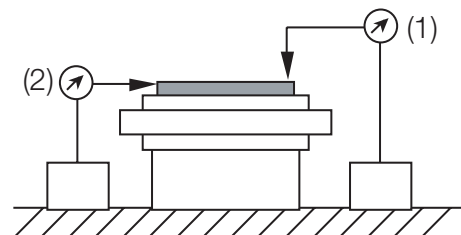
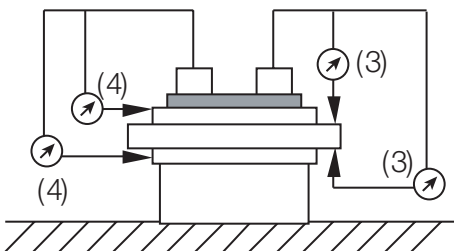
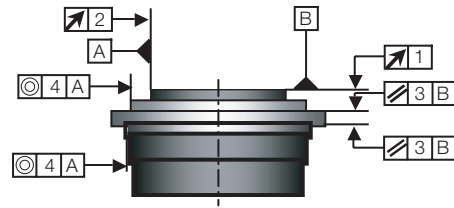

## 1-7 One-way positioning accuracy

The one-way positioning accuracy means the maximum positional difference between a commanded theoretical position and its actual angular position for serial positioning in one revolution when approached from the same direction. (refer to JIS B-6201-1987)

The one-way positioning accuracy of FHA-C actuators is almost equal to the angular positioning accuracy of the Harmonic® drive gearing, because the effect on the positioning error of the built-in motor is reduced to its 1/50 or 1/100 or 1/160 by the gearing.

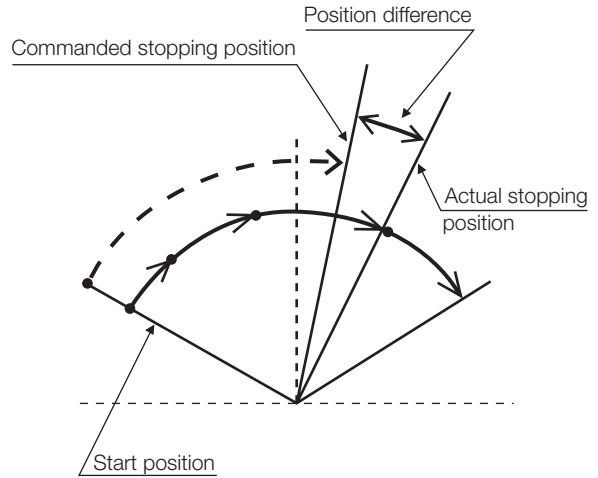

The uni-directional positioning accuracy is shown in the table below:

Item	Model	FHA-17C			FHA-25C			FHA-32C			FHA-40C		
		1:50	1:100	1:160	1:50	1:100	1:160	1:50	1:100	1:160	1:50	1:100	1:160
Uni-directional positioning accuracy	arc second	60	40	40	40	30	30	40	30	30	40	30	30

## 1-8 Encoder resolution

The motors of FHA-C actuators are equipped with an incremental encoder of 2500 resolutions or an absolute encoder of 1892 resolutions. Because the motor rotation is reduced to 1/50 or 1/100 or 1/160 by the Harmonic drive® component, the resolution of the output flange is 50 or 100 or 160 times the encoder revolution. Additionally, the incremental encoder signal is used in quadrature.

The following high resolutions are obtained:

Encoder		Incremental			Absolute		
Encoder resolution		2,500 (10,000: quadruplicated)			8,192		
Reduction Ratio		1:50	1:100	1:160	1:50	1:100	1:160
Resolution of output flange	Pulse/rev	500,000	1,000,000	1,600,000	409,600	819,200	1,310,720
Resolvable angle per pulse (All values are approximate.)	arc sec	2.6	1.3	0.8	3.2	1.6	1.0

## 1-9 Torsional Stiffness of Actuators

### 1-9-1 Moment stiffness

The moment stiffness refers to the torsional stiffness when a moment load is applied to the output flange of the actuator (shown in the figure to the right).

For example, when a load is applied to the end of an arm attached on the output flange, the face of the output flange tilts in proportion to the moment load. The moment stiffness is expressed as the torsional moment/angle.

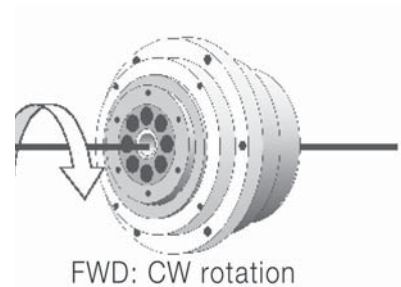

**DO NOT APPLY TORQUE, LOAD OR THRUST TO THE SLEEVE DIRECTLY.**

Since the sleeve is adhered to the output flange, the adhered sleeve may be detached from the output flange by the abnormal torque or load.

Item	Model	FHA-17C	FHA-25C	FHA-32C	FHA-40C
		N•m/rad	220 x 10 <sup>3</sup>	490 x 10 <sup>3</sup>	790 x 10 <sup>3</sup>
Moment Stiffness	Kgf•m/rad	22 x 10 <sup>3</sup>	50 x 10 <sup>3</sup>	80 x 10 <sup>3</sup>	140 x 10 <sup>3</sup>
	Kgf•m/arc-min	6.5	15	23	42

**1-9-2 Torsional Stiffness**

When a torque is applied to the output flange of the actuator with the motor locked, the resulting torsional wind up is near proportional to the torque.

The upper right figure shows the torsional stiffness characteristics of the output flange applying torque starting from zero to plus side [+T<sub>0</sub>] and minus side [-T<sub>0</sub>]. This trajectory is called torque-torsion characteristics which typically follows a loop 0→A→B→A'→B'→A as illustrated. The torsional stiffness of the FHA-C actuator is expressed by the slope of the curve that is a spring rate (wind-up) (N•m/rad).

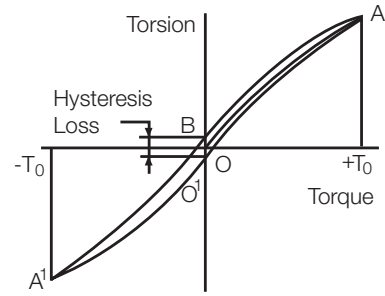

The torsional stiffness may be evaluated by dividing torque-torsion characteristics curve into three major regions. The spring rate of each region is expressed K<sub>1</sub>, K<sub>2</sub>, and K<sub>3</sub> respectively.

- K<sub>1</sub>: spring rate for torque region 0-T<sub>1</sub>
- K<sub>2</sub>: spring rate for torque region T<sub>1</sub>-T<sub>2</sub>
- K<sub>3</sub>: spring rate for torque region over T<sub>2</sub>

The wind-up for each region is expressed as follows:

- Wind-up for torque region 0-T<sub>1</sub>:  $\varphi = \frac{T}{K_1}$
- Wind-up for torque region T<sub>1</sub>-T<sub>2</sub>:  $\varphi = \theta_1 + \frac{T - T_1}{K_2}$
- Wind-up for torque region over T<sub>2</sub>:  $\varphi = \theta_2 + \frac{T - T_2}{K_3}$

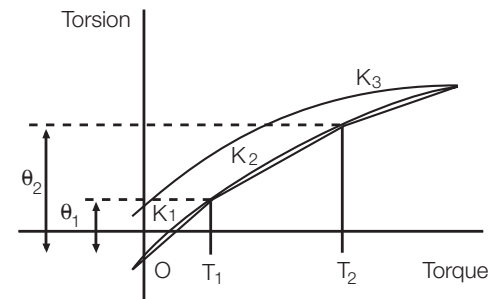

∅ φ : Wind-up

The table below shows T<sub>1</sub>-T<sub>3</sub>, K<sub>1</sub>-K<sub>3</sub>, and θ<sub>1</sub>-θ<sub>2</sub> values of each actuator.

Model	FHA-17C			FHA-25C			FHA-32C			FHA-40C			
	Reduction Ratio	1:50	1:100	1:160	1:50	1:100	1:160	1:50	1:100	1:160	1:50	1:100	1:160
T <sub>1</sub>	N•m	7.0	7.0	7.0	29	29	29	54	54	54	108	108	108
	kgf•m	0.7	0.7	0.7	3.0	3.0	3.0	5.5	5.5	5.5	11	11	11
K <sub>1</sub>	x10 <sup>4</sup> N•m/rad	1.1	1.3	1.3	4.7	6.1	6.1	8.8	11	11	17	21	21
	kgf•m/arc min	0.32	0.4	0.4	1.4	1.8	1.8	2.8	3.2	3.2	5.0	6.3	6.3
θ <sub>1</sub>	x10 <sup>-4</sup> rad	6.4	5.1	5.1	6.2	4.8	4.8	6.1	4.9	4.9	6.4	5.1	5.1
	arc min	2.2	1.8	1.8	2.1	1.7	1.7	2.1	1.7	1.7	2.2	1.8	1.8
T <sub>2</sub>	N•m	25	25	25	108	108	108	196	196	196	382	382	382
	kgf•m	2.5	2.5	2.5	11	11	11	20	20	20	39	39	39
K <sub>2</sub>	K2x10 <sup>4</sup> N•m/rad	1.3	1.7	1.7	6.1	7.7	7.7	11	14	14	21	29	29
	kgf•m/arc min	0.4	0.5	0.5	1.8	2.3	2.3	3.4	4.2	4.2	6.3	8.5	8.5
θ <sub>2</sub>	x10 <sup>-4</sup> rad	19.5	15.6	15.6	19.2	15	15	19.1	15.1	15.1	19.3	14.7	14.7
	arc min	6.7	5.4	5.4	6.6	5.1	5.1	6.4	5.2	5.2	6.6	5.0	5.0
K <sub>3</sub>	x10 <sup>4</sup> N•m/rad	2.0	2.5	2.5	8.4	11	11	15	20	20	30	37	37
	kgf•m/arc min	0.6	0.75	0.75	2.5	3.3	3.3	4.5	5.8	5.8	9	11	11

The table below shows torque-wind-up relation for reference.

(unit:N•m)

Model	FHA-17C			FHA-25C			FHA-32C			FHA-40C		
	Reduction Ratio	1:50	1:100	1:160	1:50	1:100	1:160	1:50	1:100	1:160	1:50	1:100
2 arc-min	6.3	8.1	8.1	27	37	37	51	63	63	98	129	129
4 arc-min	14	18	18	62	82	82	117	148	148	220	300	300
6 arc-min	22	29	29	97	136	136	179	243	243	340	490	490



## 1-10 Rotary direction

Forward rotary direction is defined as clockwise (CW) rotation viewing the output flange of the actuator when a driver of HA655 and HA-675 signals forward commands.

The direction can be reversed by the setting of [parameter mode]→[8: rotary direction] of the driver.

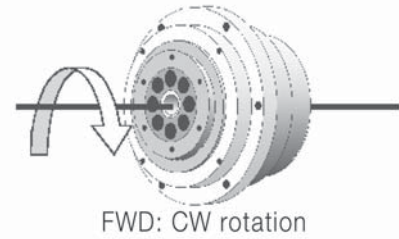

Value	FWD command	REV command	Setting
0	FWD rotation	REV rotation	Default
1	REV rotation	FWD rotation	

## 1-11 Impact resistance

The actuators are resistant to impacts along the radial axes.

Impact acceleration: 294 m/s<sup>2</sup>

However, do not apply impact to the output flange.

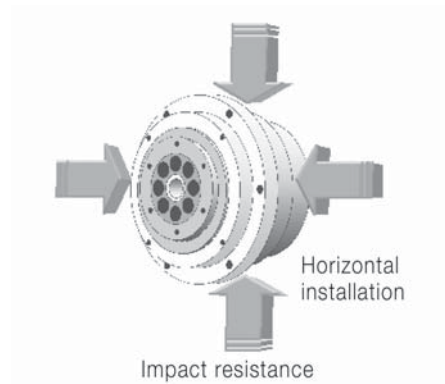

## 1-12 Vibration resistance

The allowable vibration from all directions is as follows:

Vibration acceleration: 24.5 m/s<sup>2</sup>

(Frequency:10~400Hz)

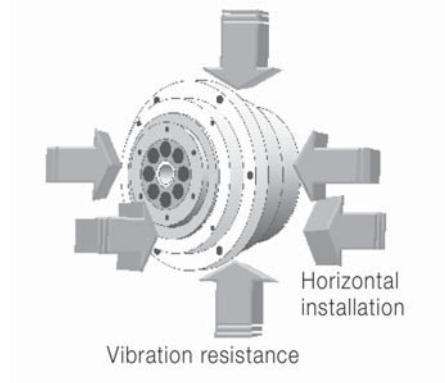

## 1-13 Torque-speed characteristics

The following are actuator speed-torque characteristics in combination with a proper the HA-655 and HA-675 driver showing allowable duty range. Refer to chapter 2 [selection guidelines] for using the FHA-C series actuators most suitably.

- Continuous duty range

The range allows continuous operation for the actuator.

- 50% duty range

The range allows the 50% duty time operation of a cycle time. Refer section 2-4-5 [duty cycle].

- Acceleration and deceleration range

The range allows instantaneous operation like acceleration and deceleration, usually.

The continuous and 50% ranges in each graph are measured on the condition of the FHA-C actuator attached on the heat radiation plate described in the figure.

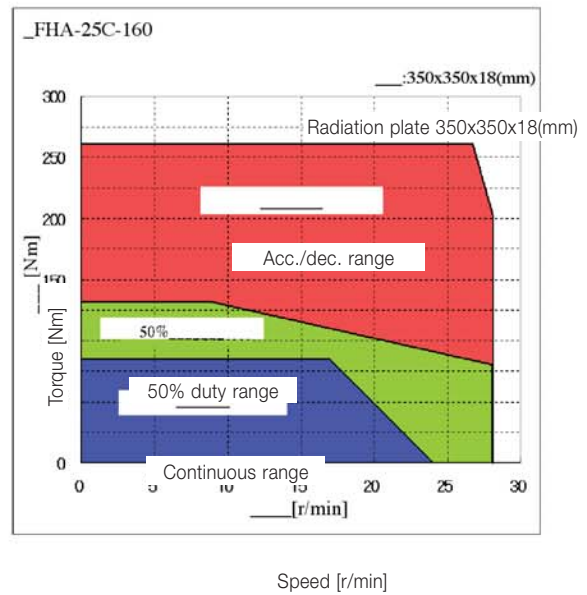
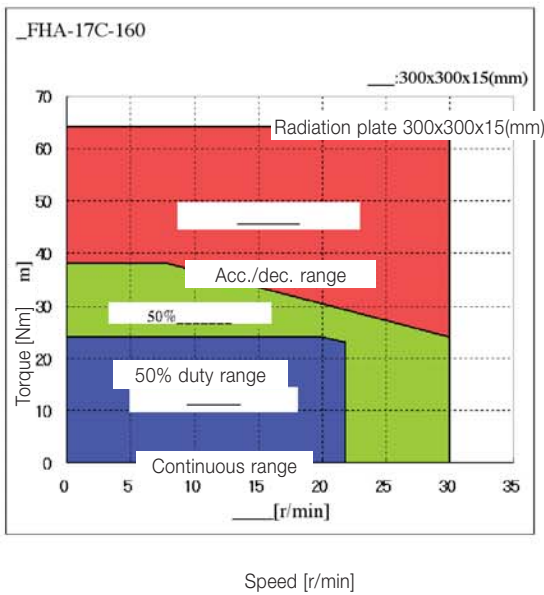
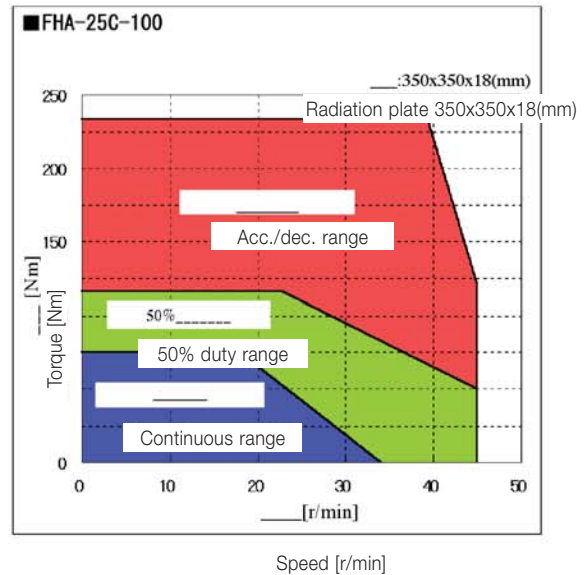
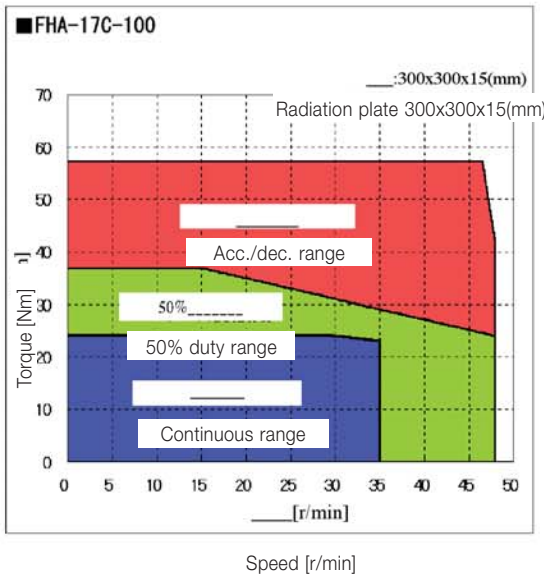
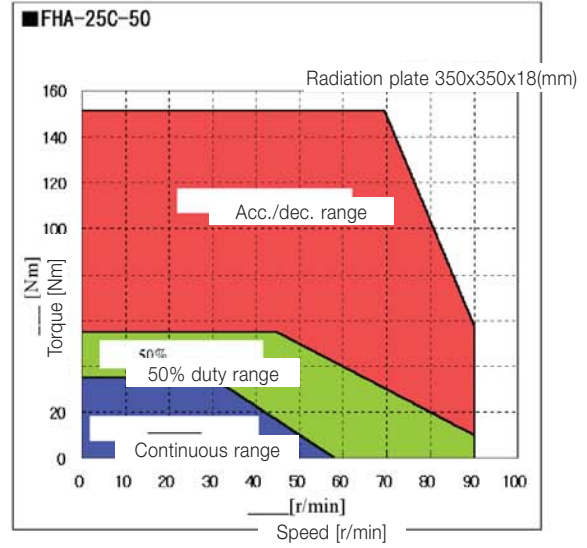
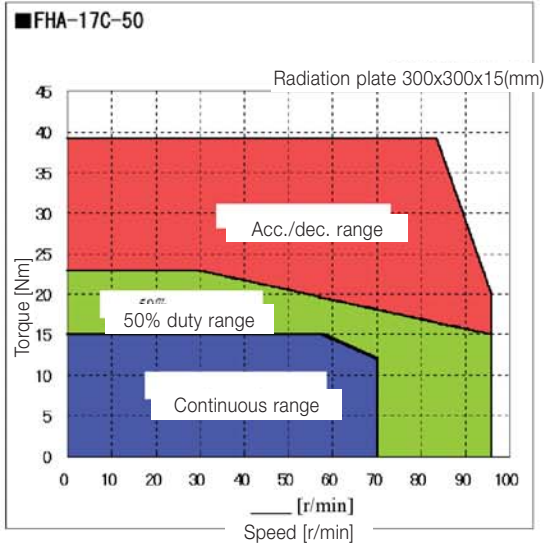

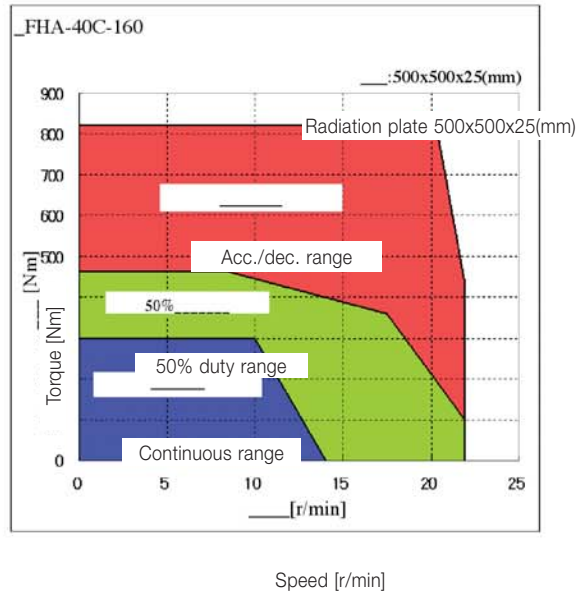
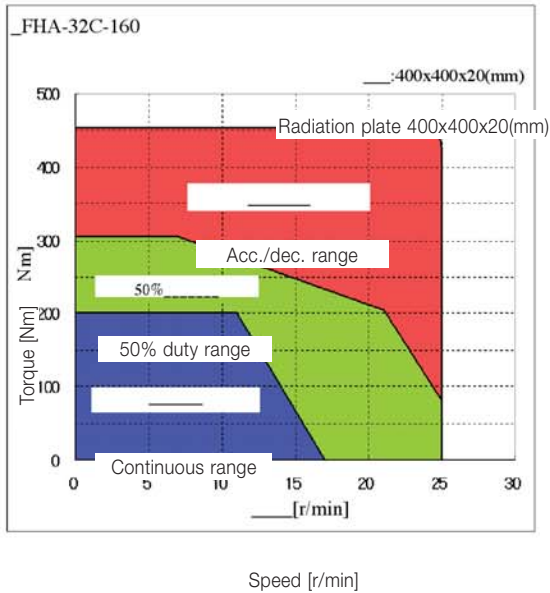
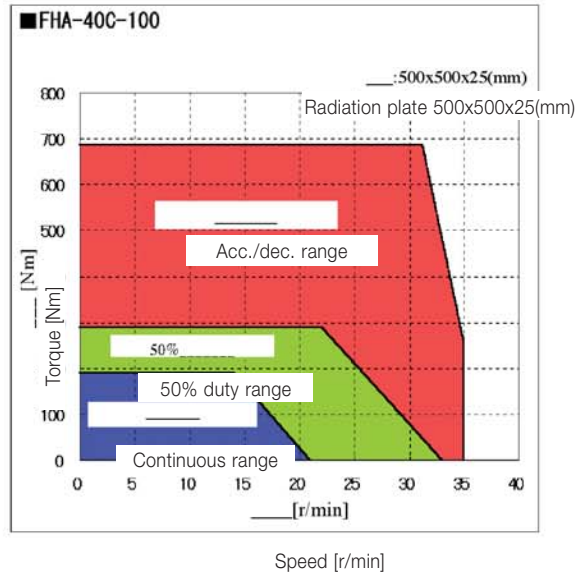
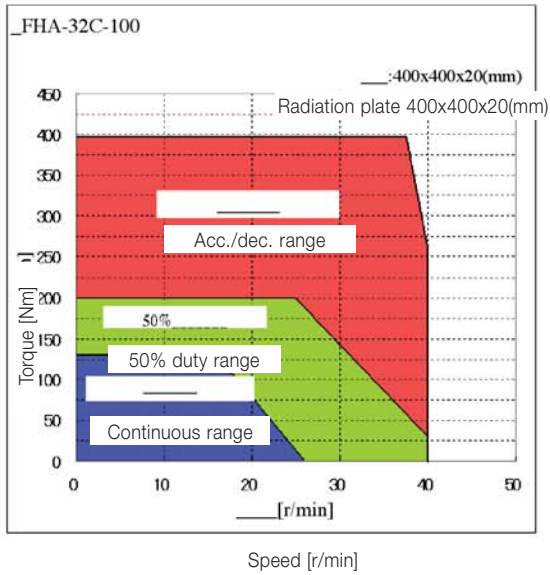
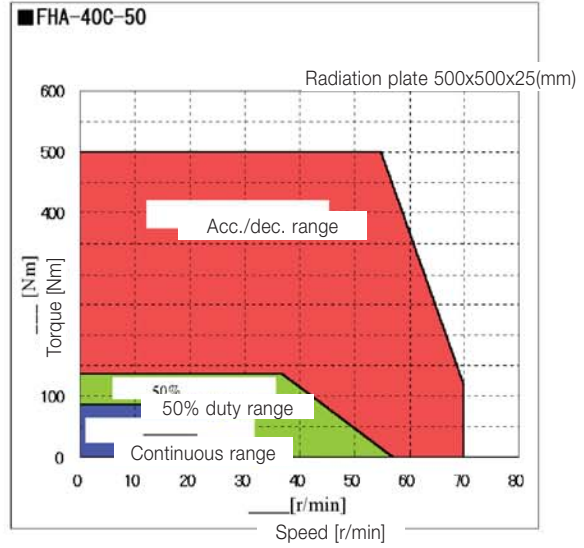
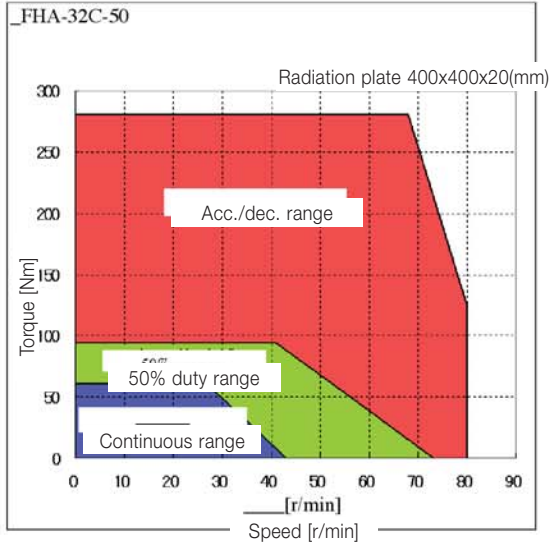

### 1-14 Cable specifications

The following tables show the lead specifications for the motors and the encoders of the FHA-C actuators.

• **Motor Cable**

Color	Motor specification	
	Standard	Brake option
Red	Motor phase-U	Motor phase-U
White	Motor phase-V	Motor phase-V
Black	Motor phase-W	Motor phase-W
Green/yellow	PE	PE
Blue	No connection	Brake
Yellow	No connection	Brake
(Shield)	FG	FG

• **Encoder Lead for 14 Wire Incremental Encoder INC**

Color	Signal	Color	Signal
Red	Vcc	Black	GND
Green	A	Green/White	A
Gray	B	Gray/White	B
Yellow	Z	Yellow/White	Z
Brown	U	Brown/White	U
Blue	V	Blue/White	V
Orange	W	Orange/White	W

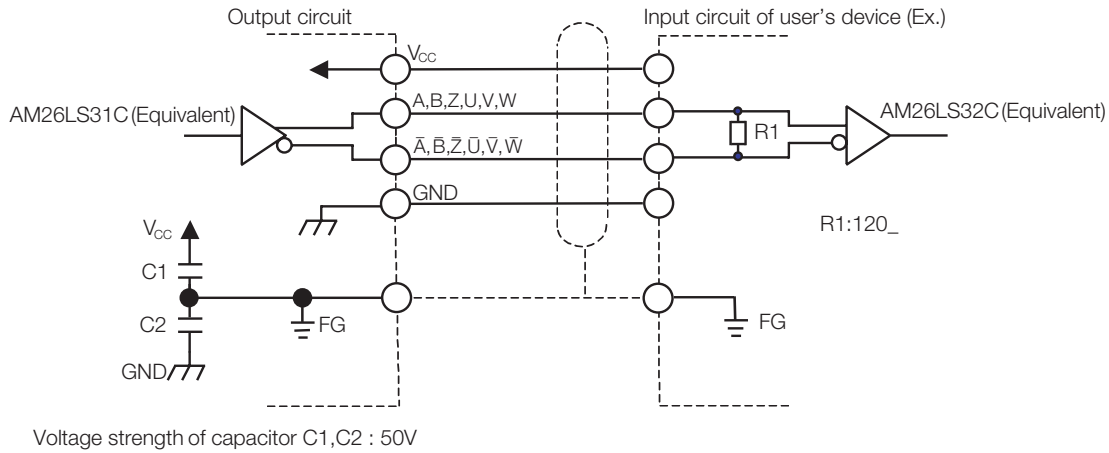

• **Encoder Lead for 4 Wire Incremental Encoder INC**

Color	Signal	Reference
Red	+5V	Power Supply
Black	0V	
Yellow	SD	Serial Signal Differential Output
Blue	SD	
(Shield)	FG	

• **Encoder Lead for Absolute Encoder ABS**

Color	Signal	Reference
Red	+5V	Power Supply
Black	0V	
White	0V	
Yellow	SD	Serial Signal Differential Output
Blue	SD	
Orange	BAT+	Battery+
Gray	BAT-	Battery-
Green	CLR	Clear Signal
(Shield)	FG	

## 1-15 Signal Waveform

### Signal waveform specifications of new version FHA-17C / 25C / 32C / 40C for US market

Figure 1 shows A, B and Z signal and relationship with U signal with CW rotation facing the encoder end (the end of the actuator output shaft.)

Figure 1

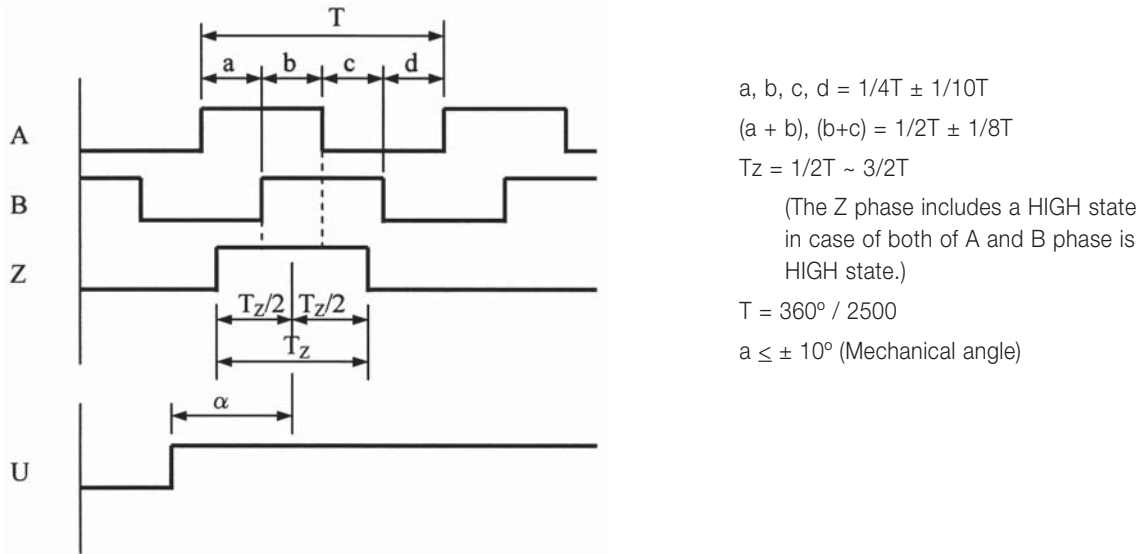
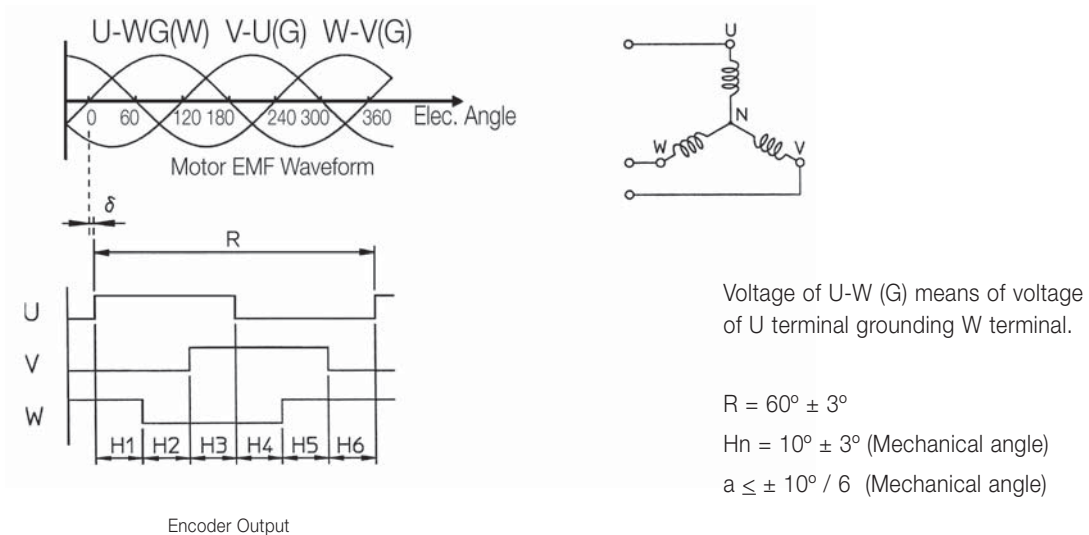

Figure 2 shows U, V, and W signal and relationship with motor's EMF with CW rotation facing the encoder end (the end of the actuator output shaft.)

Figure 2



## Chapter 2 Selection guidelines

### 2-1 Allowable load inertia

To achieve high accuracy performance, select an FHA actuator wherein the allowable moment of inertia (reference value) is greater than the load inertia.

Refer to appendix 1 for the calculation of moment inertia.

When selecting the actuator make certain that the load inertia and the maximum speed are less than the allowable values that are indicated in the table below.

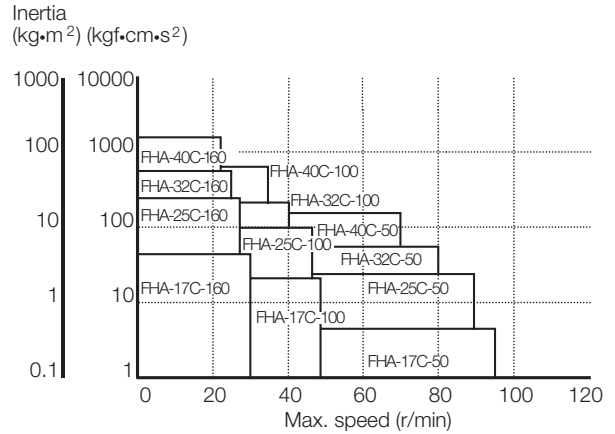

Actuator model		FHA-17C			FHA-25C			FHA-32C			FHA-40C		
		50	100	160	50	100	160	50	100	160	50	100	160
Reduction ratio		1:50	1:100	1:160	1:50	1:100	1:60	1:50	1:100	1:160	1:50	1:100	1:160
Maximum speed	(r/min)	96	48	30	90	45	28	80	40	25	70	35	22
Moment of inertia of actuator	kg·m <sup>2</sup>	0.17	0.67	1.7	0.81	3.2	8.3	1.8	7.1	18.1	4.9	19.5	50
	kgf·cm·s <sup>2</sup>	1.7	6.9	17	8.3	33	85	18	72	185	50	200	510
Allowable moment of inertia	kg·m <sup>2</sup>	0.54	2.1	5.1	2.4	10	25	5.4	21	54	15	60	150
	kgf·cm·s <sup>2</sup>	5.4	21	52	24	100	260	55	210	550	150	610	1500

### 2-2 Variable load inertia

FHA-C series actuators include Harmonic Drive® gearing that has a high reduction ratio. Because of this there are minimal effects of variable load inertias to the servo drive system. In comparison to direct servo systems this benefit will drive the load with a better servo response.

For example, assume that the load inertia increases to N-times during its motion (for example, robot arms). The effect of the variable load inertia to the [total inertia converted into motor shaft] is as follows:

The symbols in the formulas are:

- J<sub>s</sub>: Total inertia converted into motor shaft
- J<sub>M</sub>: Moment inertia of motor
- R: Reduction ratio of FHA actuator
- L: Ratio of load inertia to motor inertia
- N: Variation ratio of load inertia

- **Direct drive**

Before:  $J_s = J_M ( 1 + L )$

After:  $J_s' = J_M ( 1 + NL )$

Ratio:  $J_s'/J_s = \frac{1 + NL}{1 + L}$

- **FHA actuator drive**

Before:  $J_s = J_M \left( 1 + \frac{L}{R^2} \right)$

After:  $J_s' = J_M \left( 1 + \frac{NL}{R^2} \right)$

Ratio:  $J_s'/J_s = \frac{1 + NL / R^2}{1 + L / R^2}$

In the case of the FHA actuator drive, as the reduction ratio is [R=50], [R=100] or [R160] and the square of the reduction ratio [R<sup>2</sup>=2500], [R<sup>2</sup>=10000] or [R<sup>2</sup>=25600] the denominator and the numerator of the ratio are almost [1]. Then the ratio is [F=1]. This means that FHA drive systems are hardly effected by the load inertia variation. Therefore, it is not necessary to take the load inertia variation into consideration for selecting an FHA actuator or for setting up the HA-675 or HA-655 driver.

## 2-3 Verifying loads

The FHA-C actuators comprise a precise cross roller bearing for directly supporting the load weight. To give full ability of the actuator, verify that the maximum load weight is less than the allowable load and life and static safety coefficient of the cross roller bearing.

- **Verifying procedures:**

(1) Verifying the maximum load

Calculate the maximum load ( $M_{max}$ ,  $F_{rmax}$ ,  $F_{amax}$ ).

↓

Verify the maximum loads ( $M_{max}$ ,  $F_{rmax}$ ,  $F_{amax}$ ) are less than ( $\leq$ ) allowable loads ( $M_c$ ,  $F_r$ ,  $F_a$ )

(2) Verifying the life of the cross roller bearing

Calculate the average radial load ( $F_{rav}$ ) and the average axial load ( $F_{aav}$ ).

↓

Calculate the radial load coefficient (X) and the axial load coefficient (Y).

↓

Calculate the life of the bearing and verify the life is allowable.

(3) Verifying the static safety coefficient

Calculate the static equivalent radial load ( $P_o$ )

↓

Verify the static safety coefficient.

- **Specifications of the cross roller bearing**

The following table shows the specifications of the cross roller bearings built in FHA-C actuators.

**Table 1: Specifications of the cross roller bearings**

Model	Circular pitch of roller (dp)	Offset(R)	Basic dynamic load rating (C)	Basic static load rating (Co)	Allowable radial load (Fr)	Allowable axial load (Fa)	Allowable torsional moment (Mc)
	mm	mm	N	N	N	N	N•m
FHA-17C	77	17	10800	18700	2940	9800	188
FHA-25C	96.2	18.0	18000	33300	4900	14700	370
FHA-32C	112.2	18.5	24100	44300	9500	24500	530
FHA-40C	148.8	26.5	44900	88900	14700	39200	690

- **Calculating the maximum load**

Calculate the maximum load ( $M_{max}$ ,  $F_{rmax}$ ,  $F_{amax}$ ) with the following formula and verify that they are less than their allowances.

$$M_{max} = F_{rmax}(L_r + R) + F_{amax} \cdot L_a \quad (1)$$

Where, the variables of the formula are:

$M_{max}$ : Maximum torsional moment in N•m(kgf•m)

$F_{rmax}$ : Maximum radial load in N(kgf); See Fig.1.

$F_{amax}$ : Maximum axial load in N(kgf); See Fig.1.

$L_r$ ,  $L_a$ : Loading point in mm; See Fig.1.

$R$ : Offset; See Fig.1 and Table 1.

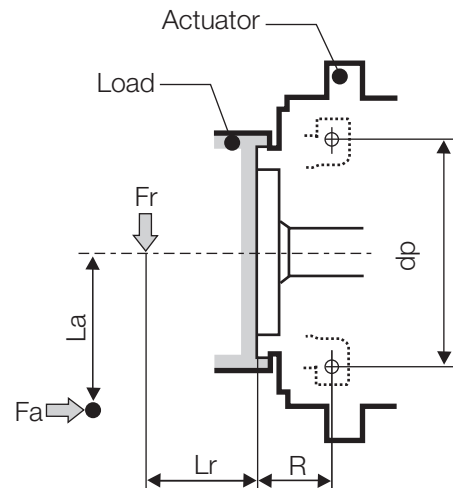

**Figure 1 Loads**

- **Calculating average loads: average radial and axial loads, average output speed**

When the radial and/or axial loads vary during motion, calculate and verify the life of the cross roller bearing converting the loads to their average values.

- **Average radial load: Frav**

$$F_{rav} = \sqrt[10/3]{\frac{n_1 t_1 |Fr_1|^{10/3} + n_2 t_2 |Fr_2|^{10/3} + \dots + n_n t_n |Fr_n|^{10/3}}{n_1 t_1 + n_2 t_2 + \dots + n_n t_n}} \quad (2)$$

Note: "Fr<sub>1</sub>" is the maximum radial load in "t<sub>1</sub>" range, and "Fr<sub>3</sub>" is the maximum radial load in "t<sub>3</sub>" range.

- **Average axial load: Faav**

$$F_{aav} = \sqrt[10/3]{\frac{n_1 t_1 |Fa_1|^{10/3} + n_2 t_2 |Fa_2|^{10/3} + \dots + n_n t_n |Fa_n|^{10/3}}{n_1 t_1 + n_2 t_2 + \dots + n_n t_n}} \quad (3)$$

Note: "Fa<sub>1</sub>" is the maximum radial load in "t<sub>1</sub>" range, and "Fa<sub>3</sub>" is the maximum radial load in "t<sub>3</sub>" range.

- **Average output speed: Nav**

$$N_{av} = \frac{n_1 t_1 + n_2 t_2 + \dots + n_n t_n}{t_1 + t_2 + \dots + t_n} \quad (4)$$

- **Calculating radial load factor and axial load factor**

Both load factors are different with average loads as follows:

- When the right formula is satisfied,

$$\frac{F_{aav}}{F_{rav} + 2(F_{rav} (L_r + R) + F_{aav} \cdot L_a) / dp} \leq 1.5 \quad (5)$$

X=1.0, and Y=0.45

- When the formula below is satisfied,

$$\frac{F_{aav}}{F_{rav} + 2(F_{rav} (L_r + R) + F_{aav} \cdot L_a) / dp} > 1.5 \quad (5')$$

X=0.67, and Y=0.67

Where, the variables of the formula are:

M<sub>max</sub>: Maximum torsional moment in N•m(kgf•m); obtained by the formula (1)

F<sub>rmax</sub>: Maximum radial load in N(kgf); See Fig.1.

F<sub>a</sub><sub>max</sub>: Maximum axial load in N(kgf); See Fig.1.

L<sub>r</sub>, L<sub>a</sub>: Loading point in mm; See Fig.1.

R: Offset; See Fig.1 and Table 1.

dp: Circular pitch of roller: See Fig.1 and Table 1.

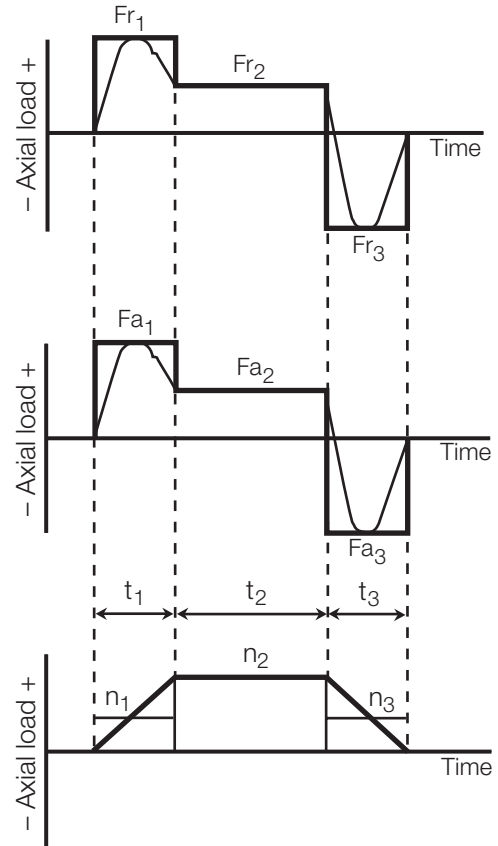



• **Equivalent dynamic radial load**

The equivalent dynamic radial load is:

$$P_c = X \cdot \left( F_{rav} + \frac{2 (F_{rav} (L_r + R) + F_{aav} \cdot L_a)}{d_p} \right) + Y \cdot F_{aav} \quad (6)$$

Where, the variables of the formula are:

- F<sub>rav</sub>: Average radial load in N(kgf); obtained by formula (2).
- F<sub>aav</sub>: Average axial load in N(kgf); obtained by formula (3).
- d<sub>p</sub>: Circular pitch of roller: See Fig.1 and Table 1.
- X: Radial load factor; obtained by formula (5)
- Y: Axial load factor; obtained by formula (5')
- L<sub>r</sub>, L<sub>a</sub>: Loading point in mm; See Fig.1.
- R: Offset; See Fig.1 and Table 1.

• **Life of cross roller bearing**

Calculate the life of cross roller bearing with the formula below:

$$L_{B-10} = \frac{10^6}{60 \times N_{av}} \times \left( \frac{C}{f_w \cdot P_c} \right)^{10/3} \quad (7)$$

Where, the variables of the formula are:

- L<sub>B-10</sub>: Life of cross roller bearing in hour
- N<sub>av</sub>: Average output speed in r/min; obtained by formula (4).
- C: Basic dynamic load rating in N (kgf). See Table 1.
- P<sub>c</sub>: Average dynamic radial load in N (kgf); obtained by formula (6) below.
- f<sub>w</sub>: Load factor:
  - For smooth operation without shock or vibration: f<sub>w</sub>=1 to 1.2
  - For normal operation: f<sub>w</sub>=1.2 to 1.5
  - For operation with shock and/or vibration: f<sub>w</sub>=1.5 to 3

• **Life of cross roller bearing for swaying motion**

Calculate the life of cross roller bearing with the formula below:

$$L_{\theta} = \frac{10^6}{60 \times n_1} \times \frac{90}{\theta} \times \left( \frac{C}{f_w \cdot P_c} \right)^{10/3} \quad (8)$$

Where, the variables of the formula are:

- L<sub>θ</sub>: Life of cross roller bearing in hour
- n<sub>1</sub>: Average output speed in r/min; obtained by formula (4).
- C: Basic dynamic load rating in N (kgf). See Table 1.
- P<sub>c</sub>: Equivalent dynamic radial load in N (kgf); obtained by formula (6).
- f<sub>w</sub>: Load factor:
  - For smooth operation without shock or vibration: f<sub>w</sub>=1 to 1.2
  - For normal operation: f<sub>w</sub>=1.2 to 1.5
  - For operation with shock and/or vibration: f<sub>w</sub>=1.5 to 3
- θ: Half of sway angle; See the right figure.

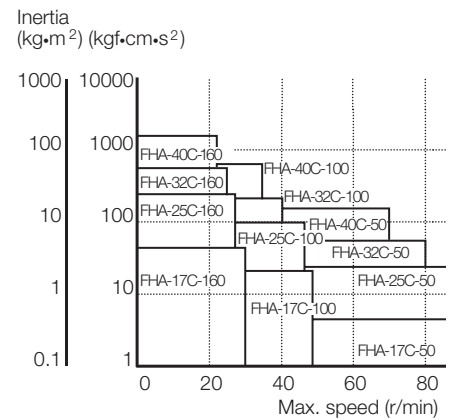

**Sway Motion**

When the sway angle is less than 5 degrees, consult to Harmonic® drive systems, because fretting wear may occur for the operation caused by no oil film between the race and the rolling element.

- **Equivalent static radial load**

Equivalent static radial load is obtained by formula (9) below.

$$P_o = F_{rmax} \frac{2M_{max}}{dp} + 0.44 F_{amax} \quad (9)$$

Where, the variables of the formula are:

- P<sub>o</sub>: Equivalent static radial load in N (kgf)
- M<sub>max</sub>: Maximum torsional moment in N•m(kgf•m); obtained by the formula (1)
- F<sub>rmax</sub>: Maximum radial load in N(kgf); See Fig.1.
- F<sub>amax</sub>: Maximum axial load in N(kgf); See Fig.1.
- dp: Circular pitch of roller: See Fig.1 and Table 1.

- **Static safety factor**

Generally, the static safety factor is limited by the basic static load rating (C<sub>o</sub>). However, for the heavy duty, the factor is limited by the following formula:

$$f_s = \frac{C_o}{P_o} \quad (10)$$

Where, the variables of the formula are:

- f<sub>s</sub>: Static safety factor;
  - For precise positioning operation:  $f_s \geq 3$
  - For operation with shock and/or vibration:  $f_s \geq 2$
  - For normal operation:  $f_s \geq 1.5$
- C<sub>o</sub>: Basic static load rating in N (kgf). See Table 1.
- P<sub>o</sub>: Equivalent static radial load in N (kgf); obtained by formula (9).

## 2-4 Duty cycles

When a duty cycle includes many frequent start and stop operations, the actuator generates heat by high starting and braking current. Therefore, it is necessary to study the duty cycle profile.

The study is as follows:

### 2-4-1 Actuator speed

Calculate the required actuator speed (r/min) to drive the load. For linear motion, convert with the formula below:

$$\text{Rotary speed (r/min)} = \frac{\text{Linear speed (mm/min)}}{\text{Pitch of screw (mm)}} \quad (9)$$

Select a reduction ratio from [50], [100] and [160] of an actuator of which the maximum speed is more than the required speed.

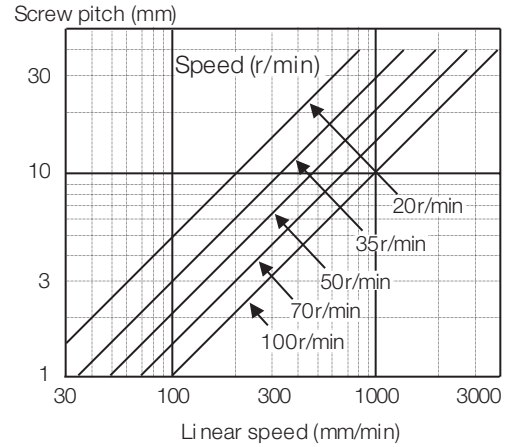

### 2-4-2 Load inertia

Calculate the load inertia driven by the FHA-C series actuator.

Refer to appendix 1 for the calculation.

Tentatively select an FHA-C actuator referring to section [2-1 allowable load inertia] with the calculated value.

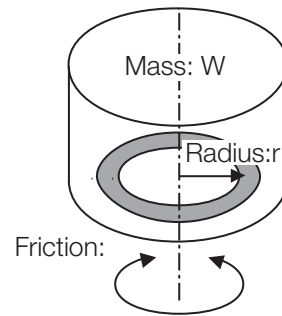

### 2-4-3 Load torque

Calculate the load torque as follows:

- **Rotary motion**

The torque for the rotating mass [W] on the friction ring of radius [r] as shown in the figure to the right.

$$T = 9.8 \times \mu \times W \times r$$

- T: torque (N•m)
- $\mu$  : coefficient of friction
- W: mass (kg)
- r: radius of friction face (m)

In the right graph, the oblique solid lines for torque have been calculated with the coefficient of the friction of  $\mu=0.1$ .

The oblique dot-chain lines show 20% torque of actuators converted from 300% torque corresponding to its maximum torque.

Ex. torque calculation (friction=0.1)  
FHA (ratio: 1/50) 30% torque of maximum torque

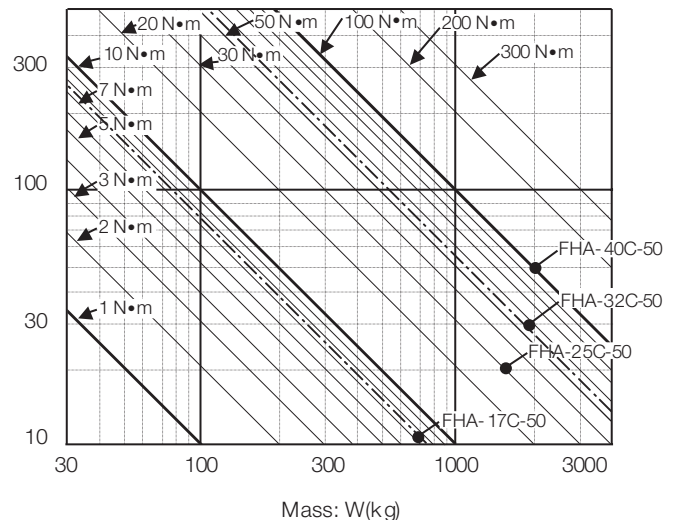

• **Horizontal linear motion**

The following formula calculates the torque for horizontal linear motion of mass [W] fed by the screw of pitch [P].

$$T = 9.8 \times \mu \times W \times \frac{P}{2 \times \pi}$$

- T : torque (N•m)
- μ : coefficient of friction
- W : mass (kg)
- P : screw pitch (m)

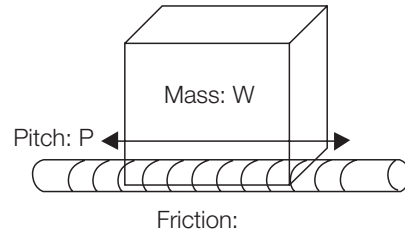

• **Vertical linear motion**

The following formula calculates the torque for vertical linear motion of mass [W] fed by the screw of pitch [P].

$$T = 9.8 \times W \times \frac{P}{2 \times \pi}$$

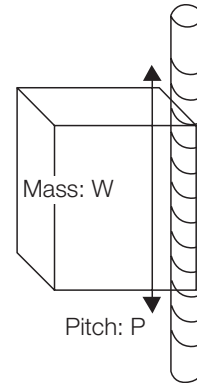

**2-4-4 Acceleration time and deceleration time**

Calculate acceleration and deceleration times for the selected actuator.

Acceleration:  $ta = (JA + JL) \times \frac{2 \times \pi}{60} \times \frac{N}{TM - TL}$

Deceleration:  $td = (JA + JL) \times \frac{2 \times \pi}{60} \times \frac{N}{TM + 2 \times TF - TL}$

- Ta: acceleration time (sec)
- Td: deceleration time (sec)
- JA: actuator inertia (kg•m<sup>2</sup>)
- JL: load inertia (kg•m<sup>2</sup>)
- N: actuator speed (r/min)
- TM: maximum torque of actuator (N•m)
- TF: actuator friction torque at max. speed (N•m)
- TF = KT x Im - TM
- where, KT: torque constant (N•m/A)
- Im: maximum current (A)
- TL: load torque (N•m)
- note that the polarity of the load torque is plus (+) for counter direction of revolution, and minus (-) for same direction.

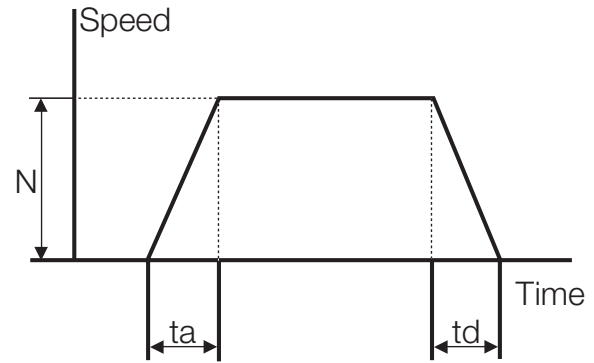

• **Example 1**

The load conditions are: Rotary speed: 60r/min  
 Moment of inertia: 1.5 kg•m<sup>2</sup>  
 Load torque is so small as to be neglected.

- (1) Referring the figure in section 2-1, FHA-25C-50 actuator is selected for the load.
- (2) Referring the specification table provided in section 1-4, JA=0.81 kg•m<sup>2</sup>, TM =150 N•m, KT=22 N•m/A, and Im =7.3A are obtained for the FHA-25C-50.
- (3) TF = 22 x 7.3 - 150 = 10.6 N•m is obtained with the formula above.
- (4) Acceleration and deceleration times are:  $ta = (0.81+1.5) \times 2 \times \pi / 60 \times 60 / 150 = 0.097$  s  
 $td = (0.81+1.5) \times 2 \times \pi / 60 \times 60 / (150 + 2 \times 10.6) = 0.085$  s
- (5) If the calculated acceleration times are too long, correct the situation by:

- Reducing load moment of inertia
- Selecting an actuator with a larger frame size

### 2-4-5 Calculating equivalent duty

The load conditions, which is torque, speed, moment of inertia, acceleration/deceleration time, loading time, are limited by the actuator to drive the load. To select the proper actuator, the equivalent duty of the load should be calculated.

The %ED (percent equivalent duty) is:

$$\%ED = \frac{K_{La} \times t_a + K_{Lr} \times t_r + K_{Ld} \times t_d}{t} \times 100$$

- where,
- ta: acceleration time in second
  - td: deceleration time in second
  - tr: driving time in second
  - t: single cycle time in second
  - KLa: duty factor for acceleration time
  - KLr: duty factor for driving time
  - KLd: duty factor for deceleration time

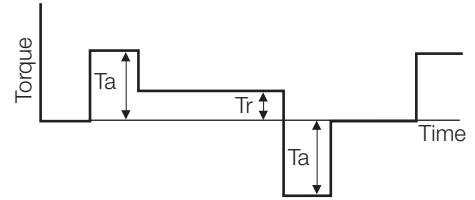
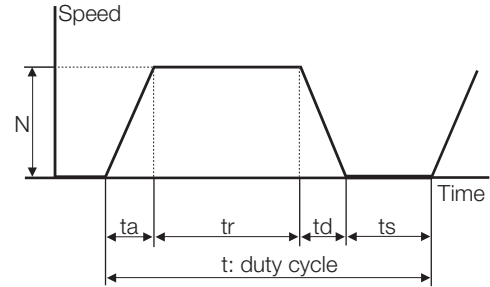

- Example 2: getting duty factors of KLa, KLr and KLd

With an example of the duty factor graph for FHA-25C-50 actuator, the way of getting the duty factors of KLa, KLr and KLd is described as follows:

The load conditions are the same as the example described in example 1: the inertia load is accelerated by the maximum torque, and is driven with a constant speed, and decelerated by the maximum torque. The displacement angle is 120 degrees and the cycle time is 2.0 s.

- (1) KLa, and KLd: the speed is desired at 30 r/min as the average of 0 and 60 r/min. Then, KLa = KLd = 7.0 from the graph.
- (2) KLr (ex.: KLr =1.0) from the graph pointing the load torque Tr (ex. Tr= 0) and driving speed (ex: Nr=60r/min).
- (3) The driving time is calculated as the area of the trapezoid of speed-time graph. Then the displacement angle is:

$$\theta = (N / 60) \times \{t_r + (t_a + t_d) / 2\} \times 360$$

$$\text{Then, } t_r = \theta / (6 \times N) - (t_a + t_d) / 2$$

As the 120 deg. is equal to 0.33rev (=120/360), the driving angle at the speed of 60r/min (=1r/s) is:  
 $t_r = (0.333-0.091)/1 = 0.242 \text{ s}$

- (4) Because the cycle time is 2.0s, the %ED is obtained as follows:

$$\%ED = (7 \times 0.097 + 1 \times 0.242 + 7 \times 0.085) / 2 \times 100 = 76\%$$

It is possible to drive the actuator with the load specifications continuously, because the %ED is less than 100%.

If the %ED is excesses 100%, correct the situation by:

- Changing the speed-time profile
- Reducing load moment of inertia
- Selecting an actuator with a larger frame size

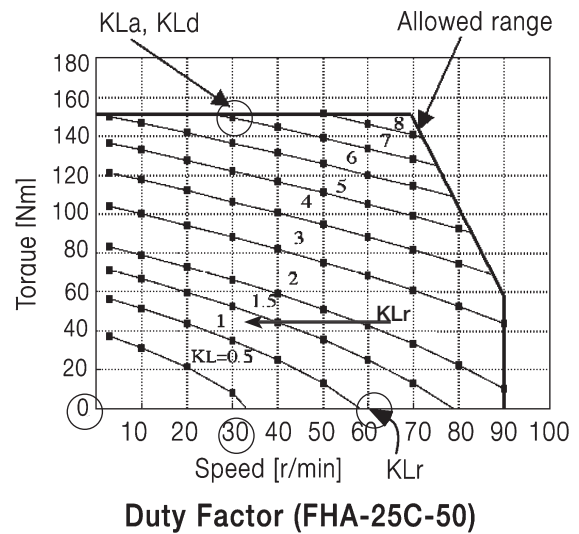

• Graphs of duty factor

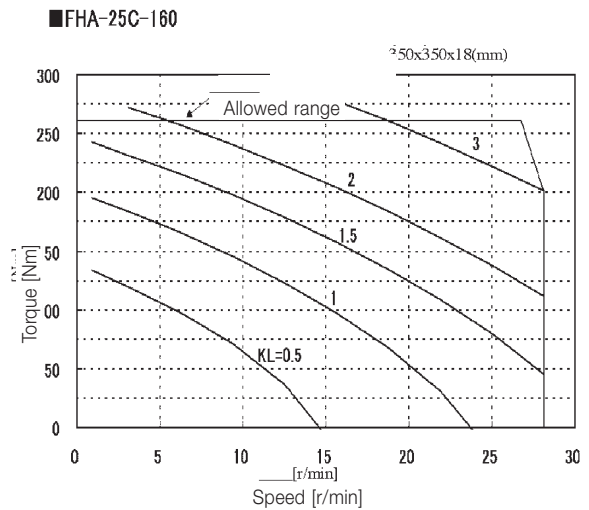
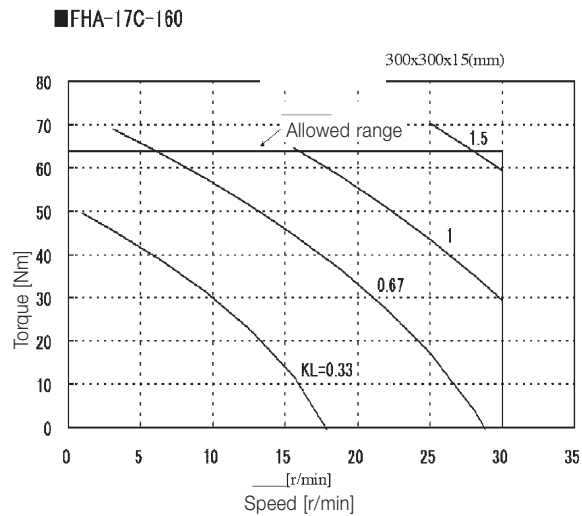
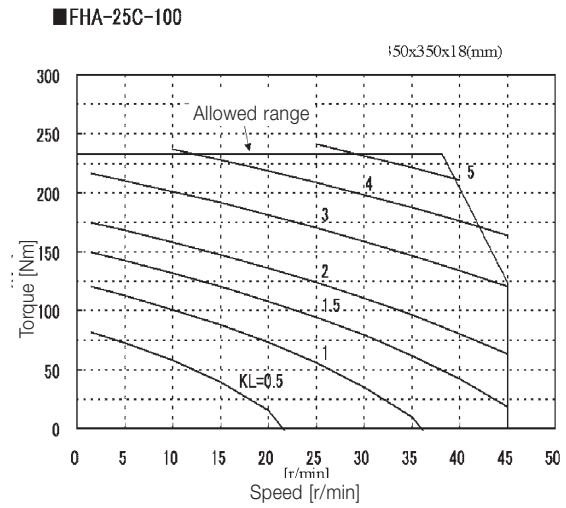
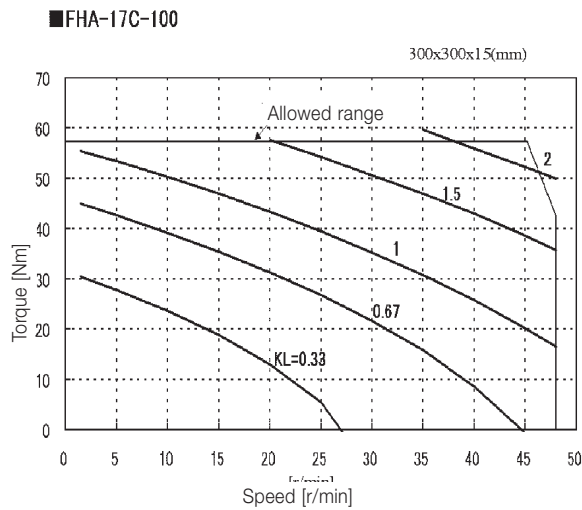
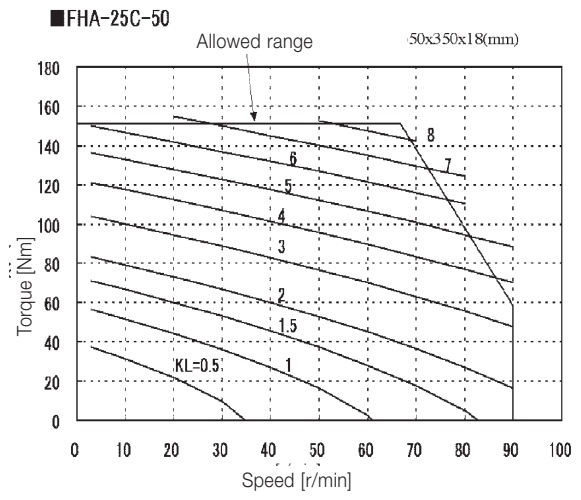
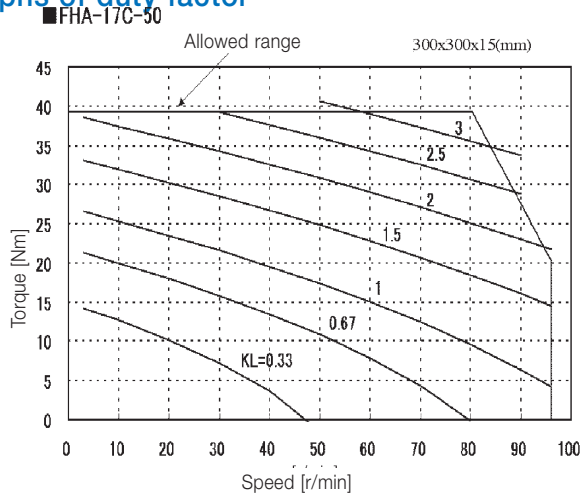

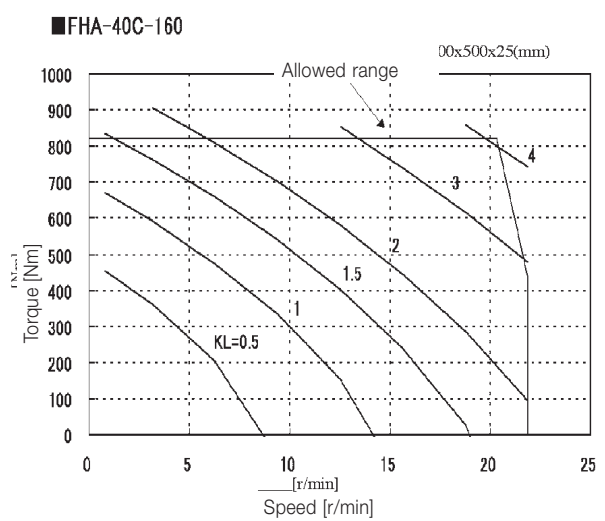
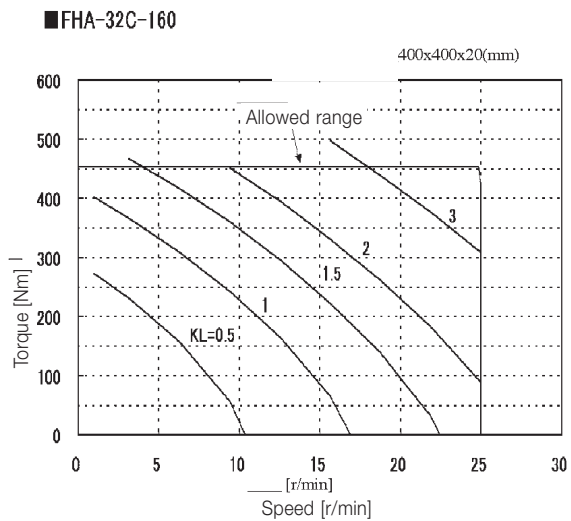
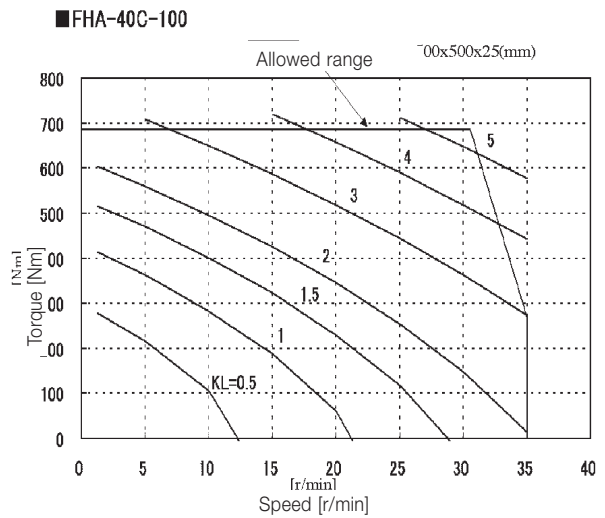
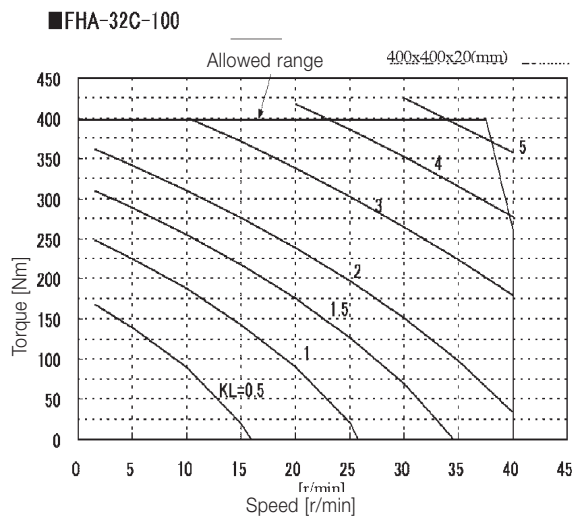
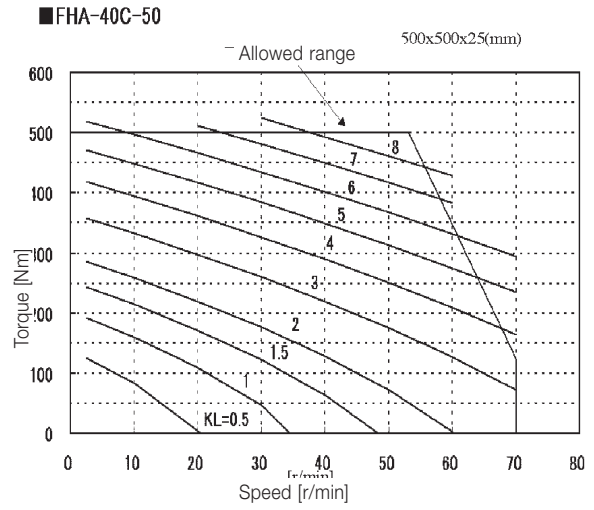
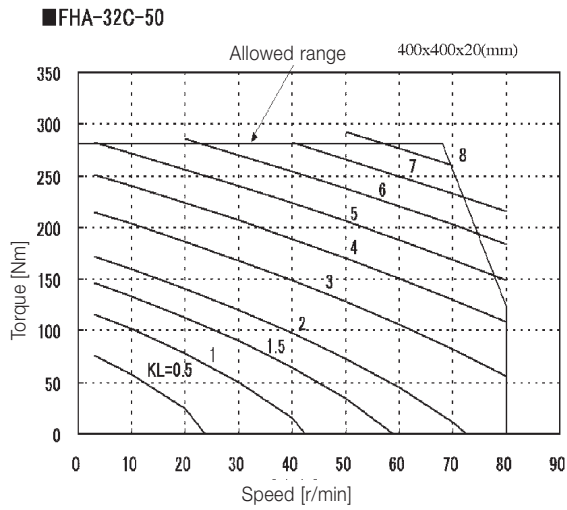

### 2-4-6 Effective torque and average speed

Additionally to the former studies, the effective torque and the average speed should be studied.

- (1) The effective torque should be less than allowable continuous torque specified by the driver.
- (2) The average speed should be less than allowable continuous speed of the actuator.

Calculate the effective torque and the average speed of an operating cycle as shown in the former figure.

$$T_m = \sqrt{\frac{T_a^2 \times (t_a + t_d) + T_r^2 \times t_n}{t}}$$

$$N_{av} = \frac{N / 2 \times t_a + N \times t_r + N / 2 \times t_d}{t}$$

- T<sub>m</sub>: effective torque (N•m)
- T<sub>a</sub>: maximum torque (N•m )
- T<sub>r</sub>: load torque (N•m)
- t<sub>a</sub>: acceleration time (s)
- t<sub>d</sub>: deceleration time (s)
- t<sub>r</sub>: running time at constant speed (s)
- t: time for one duty cycle (s)
- N<sub>av</sub>: average speed (r/min)
- N: driving speed (r/min)

If the result is greater than the value in the table below, calculate once again after reducing the duty cycle.

Model		FHA-17C			FHA-25C			FHA-32C			FHA-40C		
Items		50	100	160	50	100	160	50	100	160	50	100	160
Reduction Ratio		1:50	1:100	1:160	1:50	1:100	1:160	:50	1:100	1:160	:50	1:100	1:160
Continuous torque	N•m	15	24	24	35	75	85	60	130	200	85	190	300
Continuous speed	r/min	70	35	22	70	35	22	60	30	19	50	25	16

- Example 3: getting effective torque and average speed

The parameters are the same as the example 1 and 2 for an FHA-25C-50.

- (1) Effective torque

From the parameters of T<sub>a</sub> = T<sub>d</sub> = 150 N•m, T<sub>r</sub> = 0 N•m, t<sub>a</sub> = 0.097 s, t<sub>r</sub> = 0.243 s, t<sub>d</sub> = 0.085 s, t = 2 s,

$$T_m = \sqrt{\frac{150^2 \times (0.097 + 0.085)}{2.0}} = 45 \text{ N}\cdot\text{m}$$

As the value of T<sub>m</sub> (45N•m) exceeds its allowable continuous torque (35N•m), it is impossible to drive the actuator continuously on the duty cycle. The following equation is introduced by converting the equation for effective torque. The limited time for one duty cycle can be obtained by substituting the continuous torque for the T<sub>m</sub> of the following equation.

$$T = \frac{T_a^2 \times (t_a + t_d) + T_r^2 \times T_r}{T_m^2}$$

Substituting 150 N•m for T<sub>a</sub>, 150 N•m for T<sub>d</sub>, 0 N•m for T<sub>r</sub>, 35 N•m T<sub>m</sub>, 0.097 s for t<sub>a</sub>, 0.243 s for t<sub>r</sub>, and 0.085 s for t<sub>d</sub>:

$$T = \frac{150^2 \times (0.097 + 0.085)}{35^2} = 3.34$$

Namely, when the time for one duty cycle is set more than 3.4s, the effective torque [T<sub>m</sub>] becomes less than 34.0 N•m, and the actuator can drive the load with lower torque than the continuous torque continuously.

- (2) Average speed

From the parameters of N = 60 r/min, t<sub>a</sub> = 0.097 s, t<sub>r</sub> = 0.243 s, t<sub>d</sub> = 0.085 s, t = 3.5 s,

$$N_{av} = \frac{60/2 \times 0.097 + 60 \times 0.242 + 60/2 \times 0.085}{3.4} = 5.88 \text{ r/min}$$

As the speed is less than the continuous speed of the FHA-25C-50, it is possible to drive it continuously on new duty cycle.



### 2-4-7 Permissible overloaded time

The overloaded time is limited by the protective function in the driver even if the duty cycle is allowed. The limits are shown in the figure below.

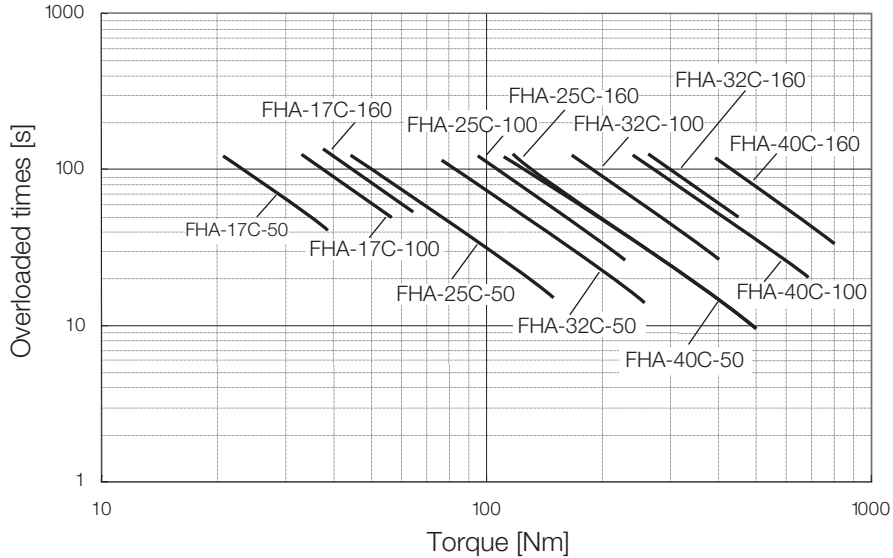

### 2-4-8 Regeneration energy

When a large inertia is accelerated and decelerated frequently, the regenerated energy will be quite large. The HA-650 driver is equipped with a regeneration resistor of 40W capacity to consume the energy. If the energy is larger than the capacity, an additional resistor is required externally.

The required capacity of the external resistor is:

$$W_r = \frac{1}{2} \left( J_A + J_L \right)^2 \times \left\{ \frac{2 \times p \times N}{60} \right\} \times \frac{1}{t} - 40 \text{ (W)}$$

Wr: capacity of external resistor (W)

JA: actuator inertia (kg•m<sup>2</sup>)

JL: load inertia (kg•m<sup>2</sup>)

N: actuator speed at deceleration (r/min)

T: time for one duty cycle (s)

Additional resistors are not required for FHA-17C and FHA-25C actuators. However, it is sometimes required for FHA-32C and FHA-40C actuators.

For reference, the graph to the right shows the required capacity of the resistor, when load inertia is three times of actuator inertia.

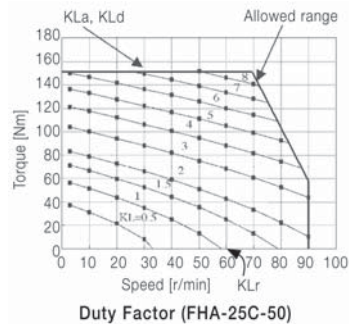
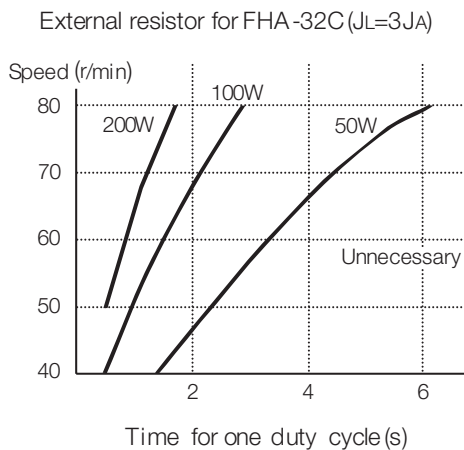

## Chapter 3 Installing the FHA-C actuator

### 3-1 Receiving Inspection

Check the following when products are received.

- **Inspection procedure**

- (1) Check the shipping container and item for any damage which may have been caused during transportation. If the item is damaged, immediately report the damage to the dealer it was purchased from.
- (2) A label is attached on the right side of the FHA actuator. Confirm the products you ordered by comparing with the model on the [TYPE] line of the label. If it is different, immediately contact the dealer it was purchased from.

The model code is interpreted as follows:

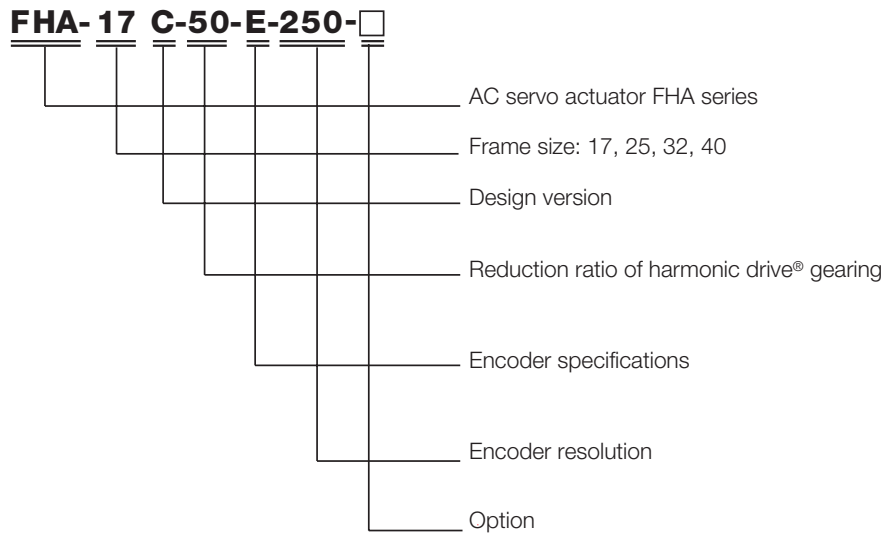

Refer the section 1-2 in this manual for the detail of the model codes.

- (3) On the label of the HA-655 or HA-675 driver, the model code of the FHA-C series actuator to be driven is indicated on the [ADJUSTED FOR USE WITH] line. Match the actuator with its driver so as not to confuse the item with the other actuators,.



**Only connect the actuator specified on the driver label.**

The drivers have been tuned for the actuator specified on the driver label. Wrong combination of drivers and FHA actuators may cause low torque problems or over current that may cause physical injury and fire.

- (4) A model of the driver is marked on the [TYPE] line of the label. The last three digits indicate the voltage of power supply.

200: 3-phase or single phase 200V  
100: single phase 100V

If the voltage to be supplied is different from the label voltage, immediately contact the dealer it was purchased from.



**Do not connect a supply voltage other than the voltage specified on the label.**

The wrong power supply voltage may damage the driver resulting in physical injury and fire.

## 3-2 Notice on handling

Handle FHA-C series actuators with care, specifically:



- (1) Do not apply impact or unnecessary excessive force to output flange of actuators.
- (2) Do not put actuators on or in a location where the driver could easily fall.
- (3) Do not plug the actuators directly into a commercial line power source.  
This could burn out the actuator, potentially resulting in a fire and/or electrical hazard.
- (4) The allowable temperature for storage is from  $-20^{\circ}\text{C}$  to  $+60^{\circ}\text{C}$ .  
Do not expose it to direct sunlight for a long time and do not store it in areas with widely fluctuating temperatures.
- (5) The allowable relative humidity for storage is less than 80%.  
Do not storage it in a highly humid place or in a place where temperature changes excessively during the course of a day.
- (6) Do not store units in locations with corrosive gas or particles.

## 3-3 Location and installation

### 3-3-1 Environment of location

The environmental conditions of the location must be as follows.

- Service temperature:  $0^{\circ}\text{C} \sim 40^{\circ}\text{C}$   
When the actuator is installed in a closed space, the temperature in the space may be higher than the atmosphere because of heat generation by the actuator. Design the closed space size, ventilation system, and device locations so the ambient temperature near the actuator is always less than  $40^{\circ}\text{C}$ .
- Service humidity: 20~80% relative humidity, without condensation  
Make sure no water condensation occurs at the place where there is a large temperature change in a day or due to frequent heat-and-cool cycles due to the operation of the actuator.
- Vibration: less than  $24.5\text{m}/\text{sec}^2$  (2.5G) (10Hz~400Hz)
- Impact: less than  $294\text{m}/\text{sec}^2$  (30G)
- Make sure the actuator is in an area free from: dust, water condensation, metal powder, corrosive gas, water, water drops, and oil mist.

Do not install the actuator in corrosive gas environment.

Take notice that the protection degree of standard actuators is IP-44, that is, all parts, except the rotary sliding parts (oil seal), of the actuators are protected against solid bodies of superior dimensions to 1mm, and against the water sprays.

- Locate the driver indoors or within an enclosure. Do not expose it to the sunlight.
- Altitude: lower than 1000m above sea level

### 3-3-2 Installation

The FHA-C series actuator is a high precision servo mechanism and great care is required for proper installation. Install the actuator taking care not to damage accurately machined surfaces. Do not hit the actuator with a hammer. Note that actuators are equipped with a glass encoder, which may be damaged by impact.

• **Procedure**

(1) Align the axis of rotation of the actuator and the load mechanism precisely.

Note 1: Very careful alignment is required especially when a rigid coupling is applied. Slight differences between centerlines will cause failure of the drive-end of the actuator.

Note 2: If needed, carefully use a wooden hammer for coupling installation.

(2) Fasten the flange of the actuator with flat washers and high strength bolts. Use a torque wrench when tightening the fasteners.

The recommended tightening torque is shown in the table below:

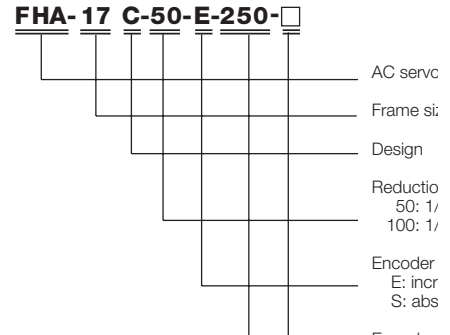

Model		FHA-17C		FHA-25C		FHA-32C		FHA-40C	
		Output Flange	Flange	Output Flange	Flange	Output Flange	Flange	Output Flange	Flange
Wrenching Torque	Screw hole depth	6-M5 depth: 8	6-M5	8-M6 depth: 10	8-M6	16-M6 depth:12	12-M6	8-M10 depth:15	8-M10
	N•m	5	3	12	7	12	7	45	25
	Kgf•cm	50	30	120	70	120	70	450	250

(3) Refer to the HA-655 or HA-675 driver manual for cable installation.

(4) Motor cable and encoder cable

Do not pull the cable with strong force, which may damage the connection. Install the cable with slack not to apply tension to the actuator. Keep the minimum bending radius more than 40mm, when the cable will be bent and stretched.



**Do not apply torque, load or thrust to the sleeve directly.**

The sleeve is adhered to the output flange, the adhered sleeve may become detached from the output flange by the illegal torque or load.



**Do not disassemble and re-assemble the actuator.**

The Harmonic Drive LLC does not guarantee the actuator that has been reassembled by others than the authorized persons by the Harmonic Drive LLC.

## Chapter 4 Options

### 4-1 AC100V power supply (option code: A)

The actuators except FHA-40C for incremental encoder system allow power supply of AC100V. Specifications of FHA-C series actuators with an incremental encoder are as follows:

Item		FHA-17C			FHA-25C			FHA-32C		
		50	100	160	50	100	160	50	100	160
Max. torque Note 2	N•m	39	57	64	150	230	260	281	398	453
	Kgf•m	4.0	5.8	6.5	15.3	23.5	26.5	28.7	40.6	46.2
Maximum speed	r/min	96	48	27	90	45	28	80	40	25
Torque constant	N•m/A	10.3	20.9	33.4	10.8	21.9	35	13.8	28.1	44.9
	Kgf•m/A	1.1	2.1	3.4	1.1	2.2	3.6	1.4	2.7	4.6
Max. current Note 2	A	4.2	3.1	2.2	15.1	11.5	8.2	18.0	15.4	11.2
Inertia of (GD <sup>2</sup> /4) actuator (J)	kg•m <sup>2</sup>	0.17	0.67	1.7	0.81	3.2	8.3	1.8	7.1	18.1
	Kgf•cm•s <sup>2</sup>	1.7	6.9	17	8.3	33	85	18	72	185
EMF constant	V/(r/min)	1.2	2.3	3.7	1.2	2.5	3.9	1.5	3.1	4.9
Phase resistance	Ω (20°C)	2.0			0.6			0.38		
Phase inductance	mH	1.5			0.6			0.5		
Reduction ratio		1:50	1:100	1:160	1:50	1:100	1:160	1:50	1:100	1:160
Allowable radial load	kN	2.9			4.9			9.5		
	kgf	300			500			970		
Allowable axial load	kN	9.8			14.7			24.5		
	kgf	1000			1500			2500		
Allowable torsional moment	N•m	188			370			530		
	Kgf•m	19			38			54		
Moment stiffness	N•m/rad	220x10 <sup>3</sup>			490x10 <sup>3</sup>			790x10 <sup>3</sup>		
	Kgf•m/rad	22x10 <sup>3</sup>			50x10 <sup>3</sup>			80x10 <sup>3</sup>		
One-way positioning accuracy	arc second	60	40	40	40	30	30	40	30	30
Motor encoder		2500 pulse/rev.			2500 pulse/rev.			2500 pulse/rev.		
Quad encoder -resolution; Note 4	Pulse/rev	500,000	1,000,000	1,600,000	500,000	1,000,000	1,600,000	500,000	1,000,000	1,600,000
Input voltage	V	100			100			100		
Mass	Kg	2.5			4.0			6.5		
Enclosure		Totally enclosed, self-cooling (equivalent to IP44)								
Environmental conditions		Service / storage temperature: 0~40°C / -20~60°C Service / storage humidity: 20~80%RH (no condensation) Vibration / impact resistance: 24.5m/s <sup>2</sup> (frequency:10-400Hz) / 294 m/s <sup>2</sup> No dust, no metal powder, no corrosive gas, no inflammable gas, no oil mist; install in room, no direct sunlight Altitude: less than 1,000 meters above sea level								
Motor insulation		Insulation resistance: 100MΩ or more (by DC500V insulation tester) Withstanding voltage: AC1500V / 1 minute Insulation class: F								
Orientation		All position								

Note 1: The table shows typical output values of actuators.

Note 2: Values for saturated temperature under the conditions that the actuator is driven by an appropriate HA-655 driver.

Note 3: Quad encoder resolutions are obtained by [motor encoder resolution] x 4 x [reduction ratio]

Note 4: The continuous range of the torque-speed characteristics of each actuators for AC 100V power is different from the range for AC 200V. For the detail of the range, please contact to Harmonic Drive System, Inc.

## 4-2 Brake for motor (option code: B)

FHA-C series actuators are possible to equip a brake on the motor shaft to hold its position during no power supply. The brake of FHA-C series actuator provides two coils for activating and for holding respectively to decrease the current during holding by an electric circuit in the actuator.

Use a DC power supply having proper output voltage and enough capacity for activating current presented in the table below.

### 4-2-1 Specifications for incremental encoder system

Item	Model	FHA-17C			FHA-25C			FHA-32C			FHA-40C		
		50	100	160	50	100	160	50	100	160	50	100	160
Type		Dry-type non-excitation electro-magnetic brake with activating coil and holding coil											
Power supply	V	DC24V +/-10%; no-polarity; note 1											
Activating current (20 °C);note 2	A	1.0			1.1			1.2			1.3		
Holding current (at 20 °C)	A	0.15			0.15			0.2			0.25		
Holding torque; note 3	N·m	24	49	78	49	98	157	75	150	240	108	216	345
	kgf·m	2.5	5	8	5	10	16	7.7	15	24	11	22	35
Actuator inertia converted for output flange; note 3	GD2/4) kg·m <sup>2</sup>	0.24	0.96	2.5	1.0	4.1	10.6	2.1	8.4	22	5.5	22	57
	(J) kgf·cm·s <sup>2</sup>	2.4	9.8	25	10	42	110	21	86	220	56	230	580
Mass of actuator; note 4	kg	2.9			4.8			7.4			14		
Service time for normal holding; note 5		100,000 times											
Service time for emergency stop; note 6		200 times											

Note 1: Power supply is user's responsibility. Use a DC power supply having proper output voltage and enough capacity for activating current presented in the table above.

Note 2: The duration for activating current is less than 0.5 second for the power supply of DC24V±10%.

Note 3: The values are converted for the output flange.

Note 4: The values present total mass of the actuator.

Note 5: The service time for normal holding is assured when the brake activates at motor speed of 150 r/min or less.

Note 6: The service time for emergency stop is assured when the brake activates at motor speed of 3000 r/min or less.



**Do not use the holding brake exceeding the service times for normal holding (100,000 times at the motor speed of 150r/min or less) nor for emergency stop (200 times at the motor speed of 3000r/min or less).**

**Over service beyond a limited time may deteriorate holding torque, and may consequently become out of use as a brake.**

### 4-2-2 Brake leads

Brake leads are included with motor leads in a motor cable. Leads are distinguished by the colors shown in the table below.

Color	Red	White	Black	Green/yellow	Blue	Yellow	shield
Lead	Motor-U	Motor-V	Motor-W	PE	Brake	Brake	FG

Note: the brake has no polarity.

### 4-3 Cable-end connectors (option code: C)

Connectors, optionally attached to the end of both cables of the motor and the encoder, are convenient for connection with the HA-655 or HA-675 driver using with the optional extension cables for the driver.

The option is effective as measures for noise suppression and additionally increases connection reliability.

- Connector for motor cable:  
receptacle: 5557-08R; female terminal: 5556PBTL  
manufactured by Molex  
(recommended connector for extension motor cable:  
plug: 5559-08P; male terminal: 5558 manufactured by Molex)
- Connector for incremental encoder cable:  
09-0009-02-04 manufactured by Franz Binder  
(recommended connector for extension encoder cable: 09-0010-02-04)
- Connector for absolute encoder cable:  
09-0471-02-08 manufactured by Franz Binder  
(recommended connector for extension encoder cable: 09-0472-02-08)

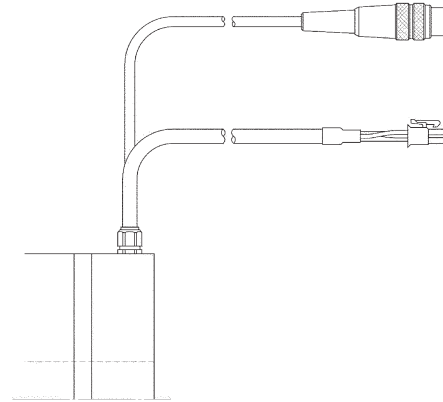

### 4-4 Cramp for output (option code: D)

The optional cramp fixes the output member of the actuator with high cramping torque. The exclusive mechanism using our machine processing technique for thin cylinder produces the cramps for applications, such as fixing a small work piece during machining or assembling.

- Applicable actuator: FHA-17C, FHA-25C

For details, refer our technical document for FHA-C actuator with cramp.

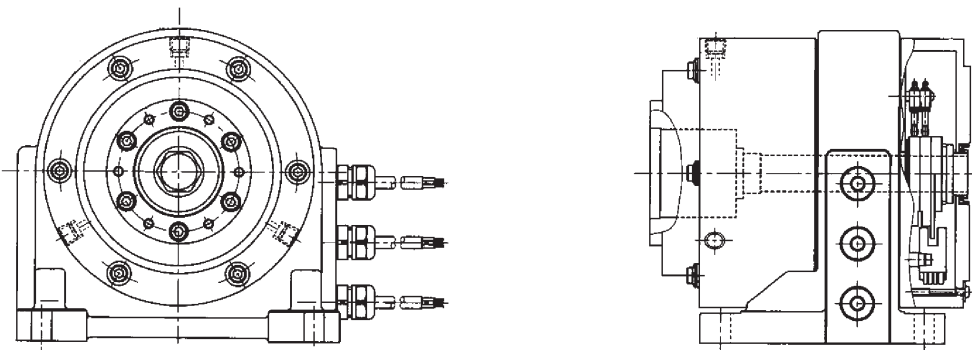

#### 4-5 5 meter cables (option code: F5)

Each cable for the motor and the encoder is possible to make 5 meters long.

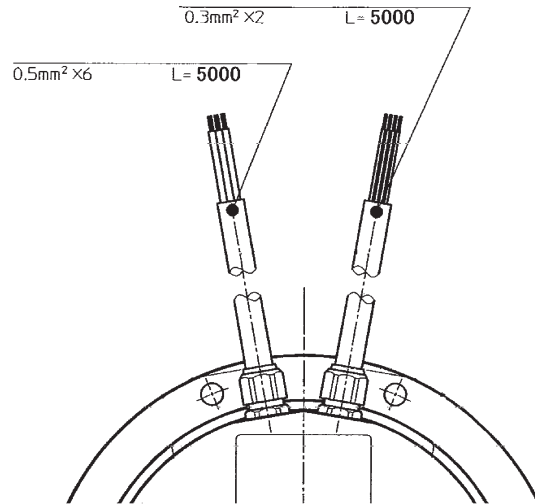

#### 4-6 Cable outlets on back face (option code: K)

It is possible to set both outlets for motor cable and the encoder cable on the back face of the actuator instead of the side face.

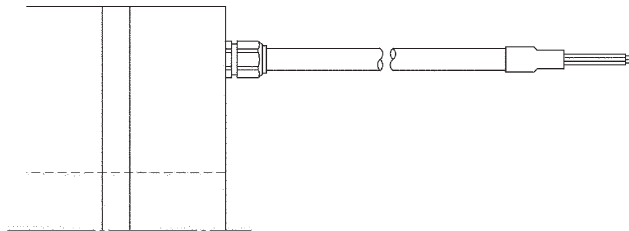



## 4-7 Rotary position sensor set (option code: L)

The rotary position sensor set is composed of three sensors for an origin and for both stroke ends. The set is assembled on the actuator shaft extended to the opposite side of the output flange. The sensor set option is effective to sense a origin for cyclic motions and to sense a stroke end for increasing safety level.

### 4-7-1 Specifications

#### (1) Origin sensor

Model: EE-SX672 manufactured by OMRON

•Output circuit

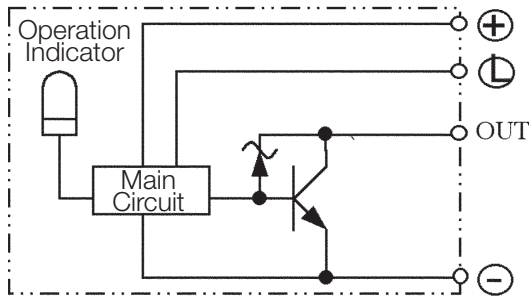

Output status: Light ON or Dark ON (selectable)  
 Power supply? DC5 to 24V±10%,  
 including 10% (p-p) maximum ripple  
 Current consumption: 35mA or less  
 Control output:DC5 to 24V, load current: (Ic)  
 100mA, residual voltage: (Vce) 0.8V maximum  
 For TTL load: load current: (Ic) 40mA, residual voltage:  
 (Vce) 0.4V maximum

•Timing chart

Light ON (Opening ⊕ and ⊙ terminals)			Dark ON (Connecting ⊕ and ⊙ terminals)		
Sensor status	Incident Interrupted		Sensor status	Incident Interrupted	
Operation indicator	ON OFF		Operation indicator	ON OFF	
Output transistor	ON OFF		Output transistor	ON OFF	

#### (2) Limit switches for both stroke ends

Model: D2JW-01K21 manufactured by OMRON

•Contact specifications

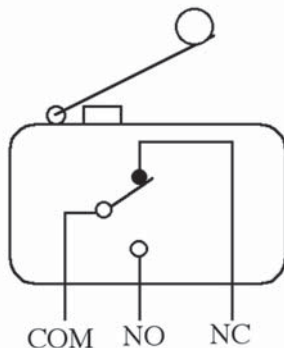

Electrical rating: DC30V 100mA (resistive load)

Operating frequency  
 Mechanical: 240 operations/min;  
 Electrical: 60 operations/min

Life expectancy  
 Mechanical: 1,000,000 operations min.  
 Electrical: 100,000 operations min.

For details, refer OMRON's catalog.

## 4-7-2 Adjusting procedures for sensor locations

The adjusting procedures are presented as follows:

1. Loosen each two screws fixing a disk with an origin slit and dogs for limit switch 1 and 2 respectively as easily as turning the dogs by hand.
2. Adjust the clockwise actuating position turning the dog for the limit switch 2, and fix it with the two loosened screws.
3. Adjust the counter-clockwise actuating position turning the dog for the limit switch 1, and fix it with the two loosened screws.
4. Turn the actuator at low speed while the origin sensor is active, and find the best position for the origin monitoring the output of the origin sensor. After finding the origin position, fix the disk with the two loosened screws.

Note 1: The screws for the disk and the dogs are fixed temporarily. Fix them tightly after adjusting above.

Note 2: Fixing measure against looseness is recommended after fixing the screws.

Note 3: Confirm generation of sensor signals at proper actuator position during test run after the adjusting.

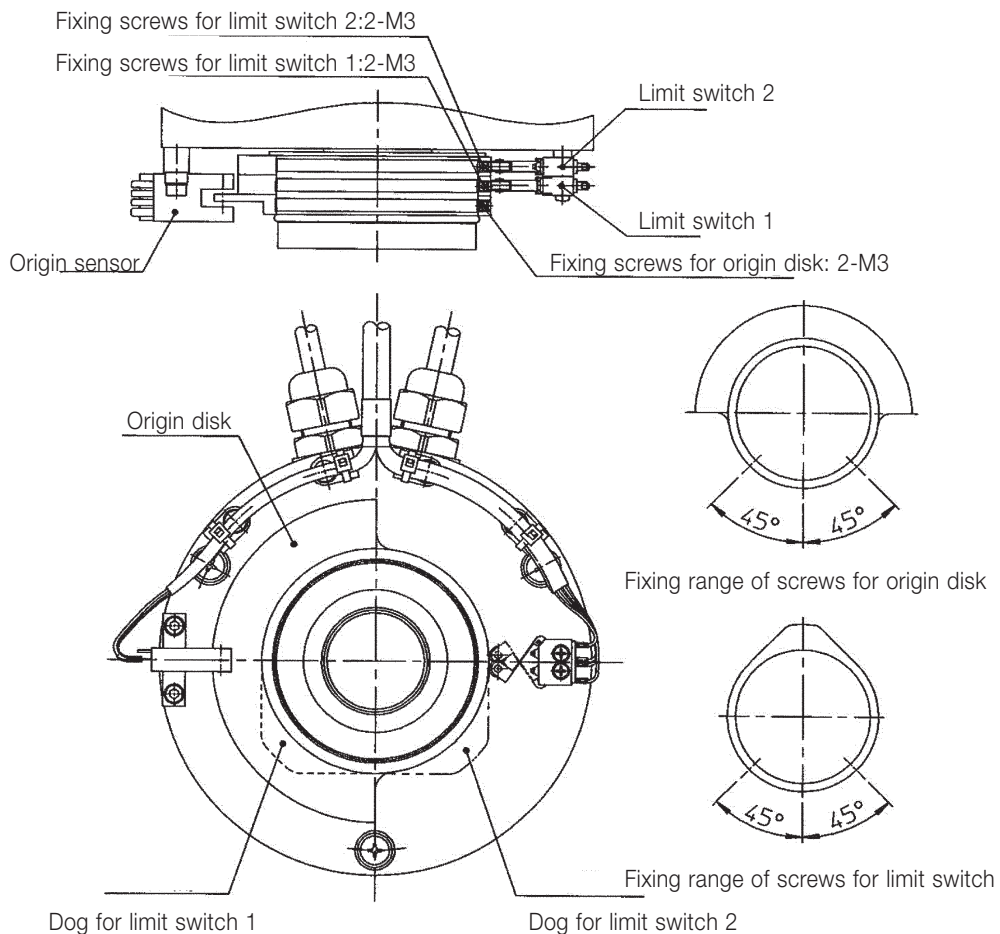

### 4-7-3 Movable range for each limit switch

The mechanical limit switches have limits for the movable range of the actuator as follows:

•FHA-17

Movable range for limit switch 1

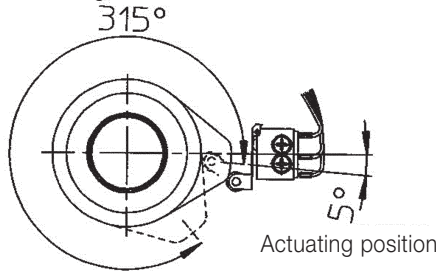

Movable range for limit switch 2

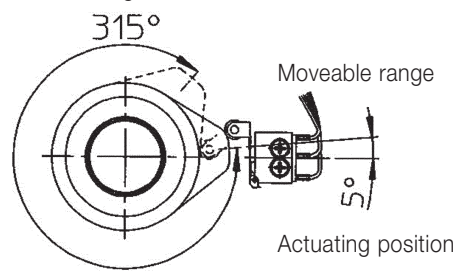

•FHA-25,32,40

Movable range for limit switch 1

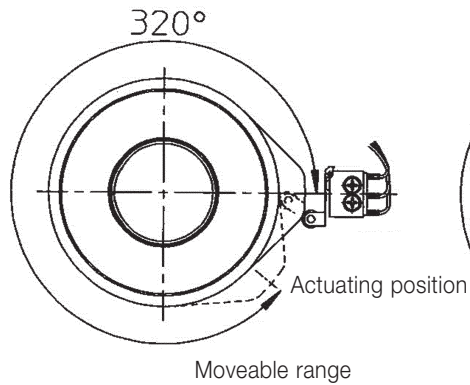

Movable range for limit switch 2

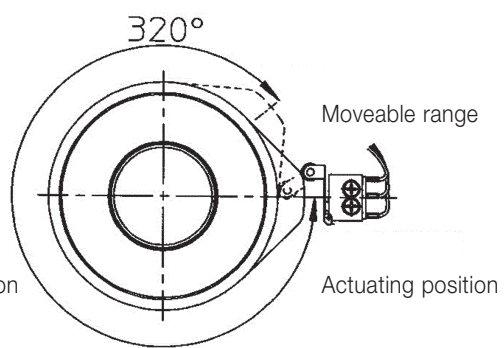

**Do not overrun beyond the moveable range mentioned above.**

The over running may damage the limit switch resulting mechanical failure and physical injury.

### 4-8 Extension cables

Three kinds of optional extension cables of 3m/5m/10m long are available for connecting an FHA-C actuator and an HA-655 or HA-675 driver: for a motor including brake wires, for an incremental encoder system, and for an absolute encoder system.

Ordering model:

for a motor: EWC-MB \*\* - M08-TN

for an incremental encoder: EWC-E \*\* - B04-3M14

for an absolute encoder: EWC-S \*\* - B08-3M14

Cable length

03	3m
05	5m
10	10m

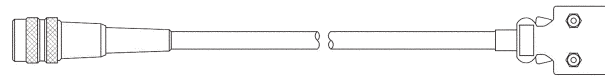
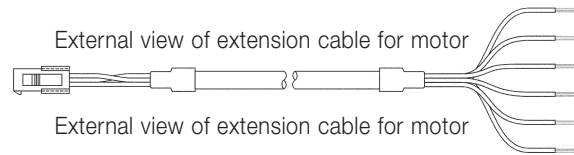

External view of extension cable for incremental or absolute encoder

Note: RS-232C communication cable is user's responsibility. Recommended cable is RS-232C cross cable with a DSUB female 9-pin connector for HA-655 or HA-675 driver: KRS-L09-2K or equivalent manufactured by Sanwa Supply.

### 4-9 Connectors

Connectors for CN1 and CN2 connectors of HA-655 or HA-675 driver, and terminal blocks for motor connection and power supply are optionally available as follows:

Ordering model: CNK-HA65-S1

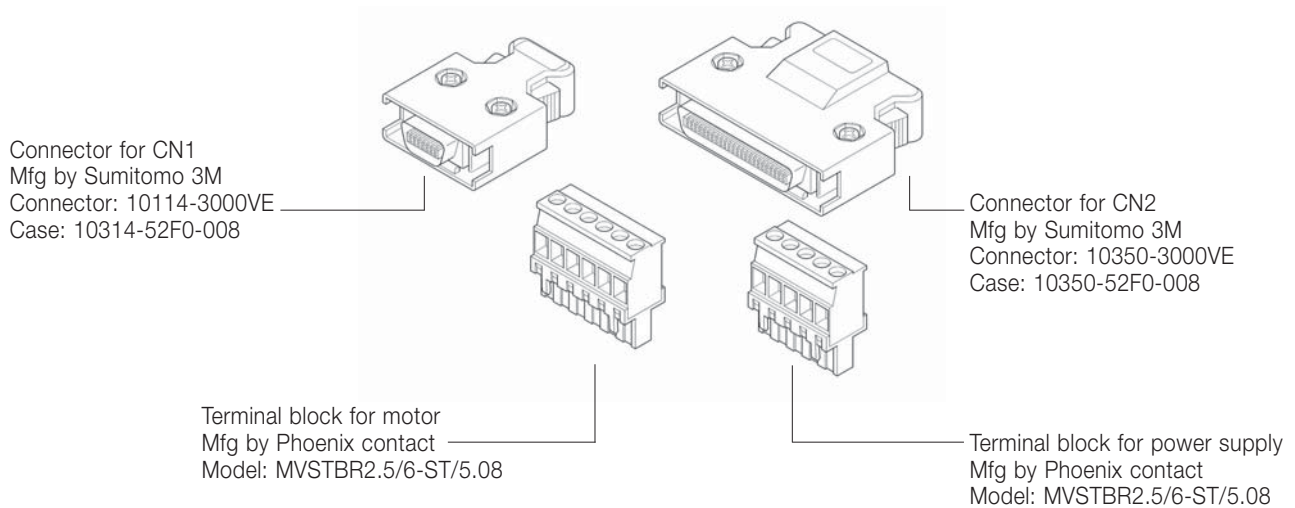

## Appendix 1 Unit conversion

This manual employs SI system for units. Conversion factors between the SI system and other systems are as follows:

### (1) Length

SI system	m	
Unit	ft.	in.
Factor	3.281	39.37

Unit	ft.	in.
Factor	0.3048	0.0254
SI system	m	

### (20) Linear speed

SI system	m/s			
Unit	m/min	ft./min	ft./s	in/s
Factor	60	196.9	3.281	39.37

Unit	m/min	ft./min	ft./s	in/s
Factor	0.0167	5.08x10 <sup>-3</sup>	0.3048	0.0254
SI system	m/s			

### (3) Linear acceleration

SI system	m/s <sup>2</sup>			
Unit	m/min <sup>2</sup>	ft./min <sup>2</sup>	ft./s <sup>2</sup>	in/s <sup>2</sup>
Factor	3600	1.18x10 <sup>4</sup>	3.281	39.37

Unit	m/min <sup>2</sup>	ft./min <sup>2</sup>	ft./s <sup>2</sup>	in/s <sup>2</sup>
Factor	2.78 x10 <sup>-4</sup>	8.47x10 <sup>-5</sup>	0.3048	0.0254
SI system	m/s <sup>2</sup>			

### (4) Force

SI system	N		
Unit	kgf	lb(force)	oz(force)
Factor	0.102	0.225	4.386

Unit	kgf	lb(force)	oz(force)
Factor	9.81	4.45	0.278
SI system	N		

### (5) Mass

SI system	kg	
Unit	lb.	oz.
Factor	2.205	35.27

Unit	lb.	oz.
Factor	0.4535	0.02835
SI system	kg	

### (6) Angle

SI system	rad		
Unit	Degree	Minute	Second
Factor	57.3	3.44x10 <sup>3</sup>	2.06x10 <sup>5</sup>

Unit	Degree	Minute	Second
Factor	0.01755	2.93x10 <sup>-4</sup>	4.88x10 <sup>-6</sup>
SI system	rad		

**(7) Angular speed**

SI system	rad/s			
Unit	deg/s	deg/min	r/s	r/min
Factor	57.3	3.44x10 <sup>3</sup>	0.1592	9.55

Unit	deg/s	deg/min	r/s	r/min
Factor	0.01755	2.93x10 <sup>-4</sup>	6.28	0.1047
SI system	rad/s			

**(7) Angular acceleration**

SI system	rad/s <sup>2</sup>	
Unit	deg/s <sup>2</sup>	deg/min <sup>2</sup>
Factor	57.3	3.44x10 <sup>3</sup>

Unit	deg/s <sup>2</sup>	deg/min <sup>2</sup>
Factor	0.01755	2.93x10 <sup>-4</sup>
SI system	rad/s <sup>2</sup>	

**(9) Torque**

SI system	N•m			
Unit	kgf•m	lb•ft	lb•in	oz•in
Factor	0.102	0.738	8.85	141.6

Unit	kgf•m	lb•ft	lb•in	oz•in
Factor	9.81	1.356	0.1130	7.06x10 <sup>-3</sup>
SI system	N•m			

**(10) Moment of inertia**

SI system	kg•m <sup>2</sup>							
Unit	kgf•m•s <sup>2</sup>	kgf•cm•s <sup>2</sup>	lb•ft <sup>2</sup>	lb•ft•s <sup>2</sup>	lb•in <sup>2</sup>	lb•in•s <sup>2</sup>	oz•in <sup>2</sup>	oz•in•s <sup>2</sup>
Factor	0.102	10.2	23.73	0.7376	3.42x10 <sup>3</sup>	8.85	5.47x10 <sup>4</sup>	141.6

Unit	kgf•m•s <sup>2</sup>	kgf•cm•s <sup>2</sup>	lb•ft <sup>2</sup>	lb•ft•s <sup>2</sup>	lb•in <sup>2</sup>	lb•in•s <sup>2</sup>	oz•in <sup>2</sup>	oz•in•s <sup>2</sup>
Factor	9.81	0.0981	0.0421	1.356	2.93x10 <sup>-4</sup>	0.113	1.829x10 <sup>-5</sup>	7.06x10 <sup>-3</sup>
SI system	kg•m <sup>2</sup>							

**(11) Torsional spring constant, moment stiffness**

SI system	N•m/rad				
Unit	kgf•m/rad	kgf•m/arc min	kgf•m/deg	lb•ft/deg	lb•in/deg
Factor	0.102	2.97x10 <sup>-5</sup>	1.78x10 <sup>-3</sup>	0.0129	0.1546

Unit	kgf•m/rad	kgf•m/arc min	kgf•m/deg	lb•ft/deg	lb•in/deg
Factor	9.81	3.37x10 <sup>4</sup>	562	77.6	6.47
SI system	N•m/rad				

## Appendix 2 Moment of inertia

### 1. Calculation of mass and moment of inertia

#### (1) Both centerlines of rotation and gravity are the same:

The following table includes formulas to calculate mass and moment of inertia.

m: mass (kg); I<sub>x</sub>, I<sub>y</sub>, I<sub>z</sub>: moment of inertia for rotation center of x-, y-, z-axis respectively (kg•m<sup>2</sup>);  
G: distance from gravity center to the surface; ρ: specific gravity

Unit Length: m; Mass: kg; Inertia: kg•m<sup>2</sup>

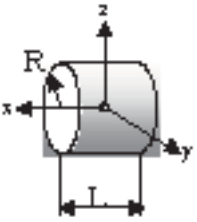
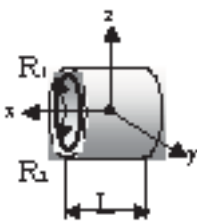
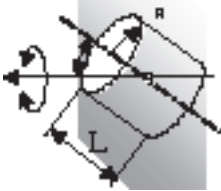
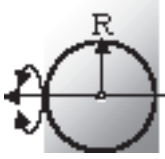
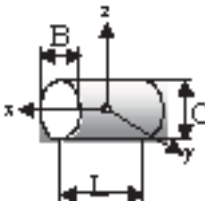
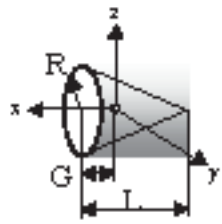
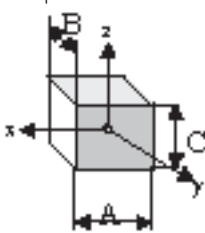
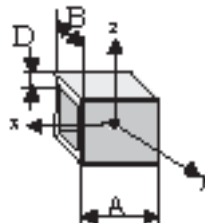
Object form	Mass, inertia, gravity center	Object form	Mass, inertia, gravity center
<p>Cylinder</p> 	$m = \pi R^2 L \rho$ $I_x = \frac{1}{2} m R^2$ $I_y = \frac{1}{4} m \left( R^2 + \frac{L^2}{3} \right)$ $I_z = \frac{1}{4} m \left( R^2 + \frac{L^2}{3} \right)$	<p>Circular pipe</p>  <p>R<sub>1</sub>:outer, R<sub>2</sub>:inner</p>	$m = \rho \left( R_1^2 - R_2^2 \right) L$ $I_x = \frac{1}{2} m \left( R_1^2 + R_2^2 \right)$ $I_y = \frac{1}{4} m \left[ \left( R_1^2 + R_2^2 \right) + \frac{L^2}{3} \right]$ $I_z = \frac{1}{4} m \left[ \left( R_1^2 + R_2^2 \right) + \frac{L^2}{3} \right]$
<p>Slanted cylinder</p> 	$m = \pi R^2 L \rho$ $I_e = \frac{1}{12} m \times \left[ R^2 \left( 1 + \cos^2 \theta \right) + L^2 \sin^2 \theta \right]$	<p>Ball</p> 	$m = \frac{4}{3} \rho R^3$ $I = \frac{2}{5} m R^2$
<p>Ellipsoidal cylinder</p> 	$I_x = \frac{1}{16} m \left( B^2 + C^2 \right)$ $I_y = \frac{1}{4} m \left( \frac{C^2}{4} + \frac{L^2}{3} \right)$ $I_z = \frac{1}{4} m \left( \frac{B^2}{4} + \frac{L^2}{3} \right)$	<p>Cone</p> 	$m = \frac{\rho}{3} \pi R^2 L$ $I_x = \frac{3}{10} m R^2$ $I_y = \frac{3}{80} m \left( R^2 + L^2 \right)$ $I_z = \frac{3}{80} m \left( R^2 + L^2 \right)$ $G = \frac{L}{4}$
<p>Rectangular pillar</p> 	$m = ABC \rho$ $I_x = \frac{1}{12} m \left( B^2 + C^2 \right)$ $I_y = \frac{1}{12} m \left( C^2 + A^2 \right)$ $I_z = \frac{1}{12} m \left( A^2 + B^2 \right)$	<p>Square pipe</p> 	$m = 4AD(B-D)\rho$ $I_x = \frac{1}{3} m \left[ \frac{(B-D)^2}{3} + D^2 \right]$ $I_y = \frac{1}{6} m \left[ A^2 + \frac{(B-D)^2}{3} + D^2 \right]$ $I_z = \frac{1}{6} m \left[ A^2 + \frac{(B-D)^2}{3} + D^2 \right]$

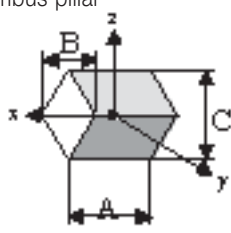
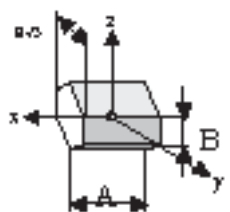
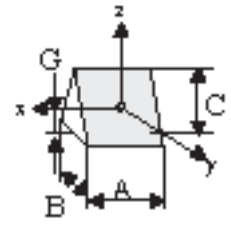
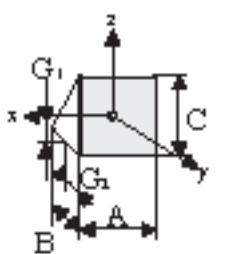
Object form	Mass, inertia, gravity center	Object form	Mass, inertia, gravity center
Rhombus pillar 	$m = \frac{1}{2} ABC \rho$ $I_x = \frac{1}{24} m (B^2 + C^2)$ $I_y = \frac{1}{24} m (C^2 + 2A^2)$ $I_z = \frac{1}{24} m (B^2 + 2A^2)$	Hexagonal pillar 	$m = \frac{3\sqrt{3}}{2} AB^2 \rho$ $I_x = \frac{5}{12} m B^2$ $I_y = \frac{1}{12} m \left( A^2 + \frac{5}{2} B^2 \right)$ $I_z = \frac{1}{12} m \left( A^2 + \frac{5}{2} B^2 \right)$
Isosceles triangle pillar 	$m = \frac{1}{2} ABC \rho$ $I_x = \frac{1}{12} m \left( \frac{B^2}{2} + \frac{2}{3} C^2 \right)$ $I_y = \frac{1}{12} m \left( A^2 + \frac{2}{3} C^2 \right)$ $I_z = \frac{1}{12} m \left( A^2 + \frac{B^2}{2} \right)$ $G = \frac{C}{3}$	Right triangle pillar 	$m = \frac{1}{2} ABC \rho$ $I_x = \frac{1}{36} m (B^2 + C^2)$ $I_y = \frac{1}{12} m \left( A^2 + \frac{2}{3} C^2 \right)$ $I_z = \frac{1}{12} m \left( A^2 + \frac{2}{3} B^2 \right)$ $G_1 = \frac{C}{3} \quad G_2 = \frac{B}{3}$

• Example of specific gravity

The following tables show references of specific gravity. Confirm the specific gravity for the material of the drive load.

Material	Gravity
SS45C	7.86
SS41C	7.85
Cast steel	7.85
Cast iron	7.19
Copper	8.92

Material	Gravity
Bronze	8.5
Aluminum	2.7
Duralumin	2.8
Teflon	2.2
Fluorocarbon resin	2.2

Material	Gravity
Epoxy resin	1.9
ABS	1.1
Silicon resin	1.8
Polyurethane rubber	1.25
Chloroprene rubber	1.15

(2) Both center lines of rotation and gravity are not the same:

The following formula calculates the moment of inertia when the rotary center is different from the gravity center.

$$I = I_g + mF^2$$

- I: Inertia when both centers are not the same (kg•m<sup>2</sup>)
- I<sub>g</sub>: Inertia when both centers are the same (kg•m<sup>2</sup>)
- Calculate with formulas described in (1).
- m: Mass (kg)
- F: Distance between rotary center and gravity center (m)

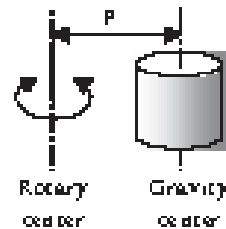

(3) Inertia of linearly moving objects

The inertia, converted to the actuator axis, of linear moving objects is calculated with the formula as follows:

$$I = m \left( \frac{P}{2\pi} \right)^2$$

- I: Inertia of linearly moving objects, converted to the actuator axis (kg•m<sup>2</sup>)
- m: Mass (kg)
- P: Displacement per one revolution of actuator (m/rev)



## 2 Inertia of cylinder

The moment of inertia of a cylinder may be obtained from the graphs to the right.

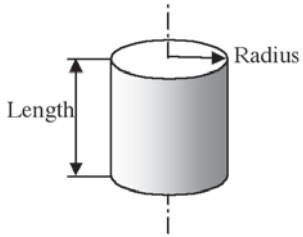

The above graph is applied for aluminum (specific gravity: 2.7) and the lower for steel (specific gravity: 7.85).

The double-dot-chain lines indicate the allowable inertia for each actuator.

(Example)

Material: Aluminum  
 Diameter: 100mm  
 Length: 7mm  
 Form: cylinder

As the diameter is 100mm, the radius is 50mm. Therefore, the above graph would indicate that the inertia is:

Approx.  $1.9 \times 10^{-4} \text{ kg} \cdot \text{m}^2$

(Exact value:  $0.000186 \text{ kg} \cdot \text{m}^2$ )

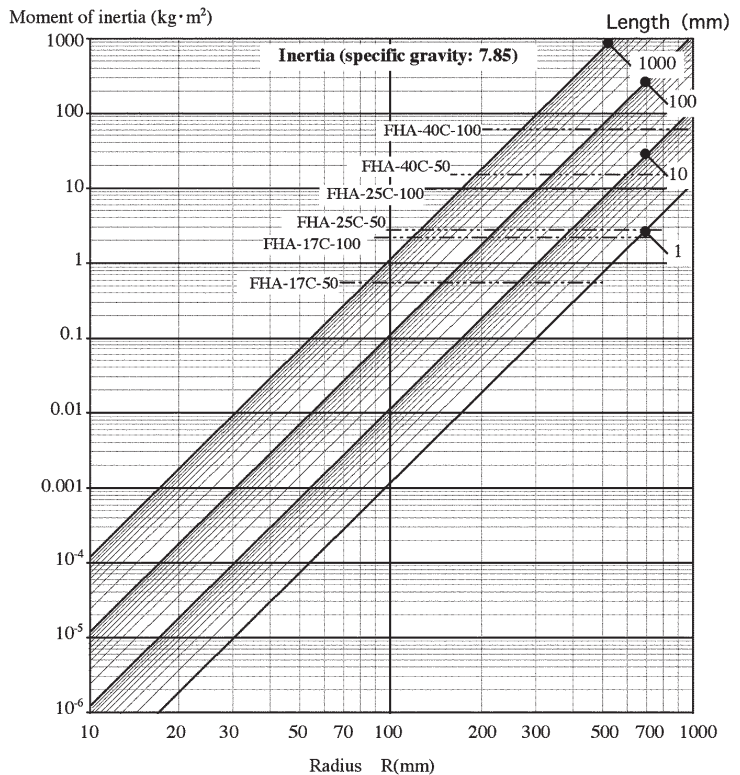
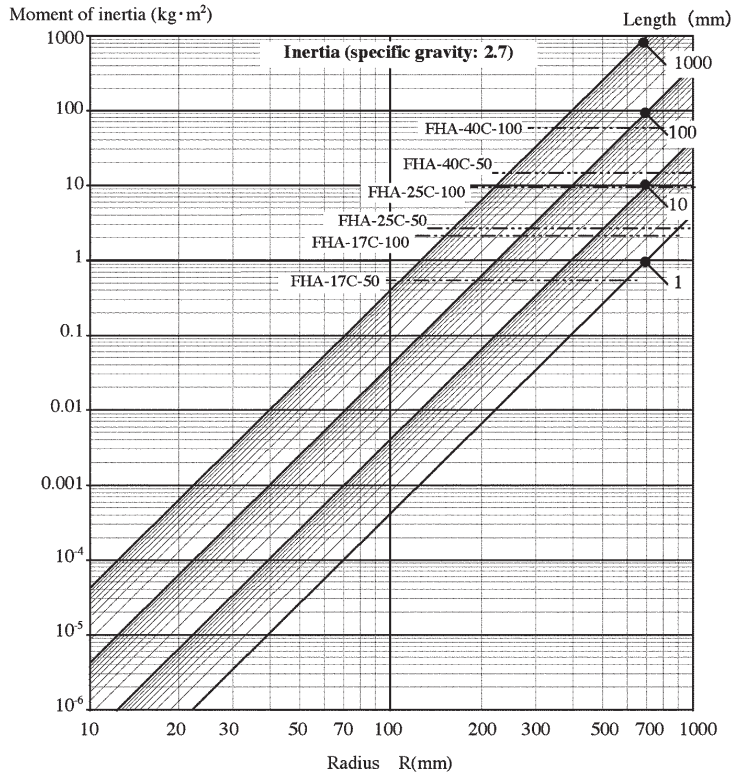

**The FHA-C series actuators are warranted as follows:**

- **Warranty period**

Under the condition that the actuator are handled, used and maintained properly followed each item of the documents and the manuals, all the FHA-C series actuators are warranted against defects in workmanship and materials for the shorter period of either one year after delivery or 2,000 hours of operation time.

- **Warranty terms**

All the FHA-C series actuators are warranted against defects in workmanship and materials for the warranted period. This limited warranty does not apply to any product that has been subject to:

- (1) user's misapplication, improper installation, inadequate maintenance, or misuse.
- (2) disassembling, modification or repair by others than Harmonic Drive LLC.
- (3) imperfection caused by the other than the FHA-C series actuator and the HA-650/670 servo driver.
- (4) disaster or others that does not belong to the responsibility of Harmonic Drive LLC

All products are warranted to be free from design or manufacturing defects for a period of one year from the date of shipment. Such items will be repaired or replaced at the discretion of Harmonic Drive LLC. The seller makes no warranty, expressed or implied, concerning the material to be furnished other than it shall be of the quality and specifications stated. The seller's liability for any breach is limited to the purchase price of the product. All efforts have been made to assure that the information in this catalog is complete and accurate. However, Harmonic Drive LLC is not liable for any errors, omissions or inaccuracies in the reported data. Harmonic Drive LLC reserves the right to change the product specifications, for any reason, without prior notice.

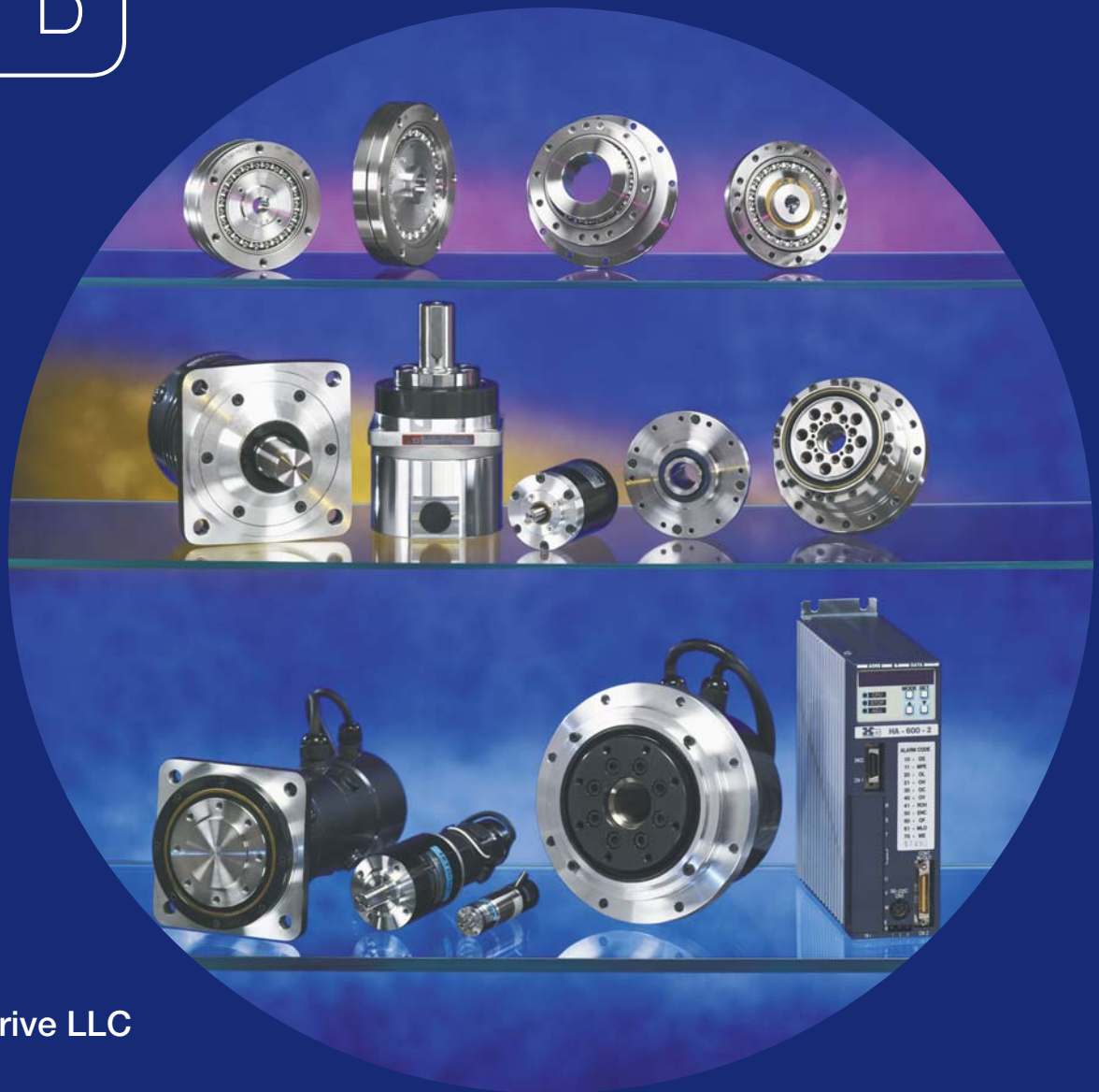

## Harmonic Drive LLC

### **Boston**

247 Lynnfield Street  
Peabody, MA 01960

### **New York**

89 Cabot Court  
Hauppauge, NY 11788

800-921-3332

F: 978-532-9406

[www.HarmonicDrive.net](http://www.HarmonicDrive.net)

### **Worldwide Locations:**

Harmonic Drive Systems, Inc.  
Minamiohi 6-25-3, Shinagawa-ku  
Tokyo 140, Japan

Harmonic Drive AG  
Hoenbergstr, 14  
Limburg/Lahn, D-65555 Germany