

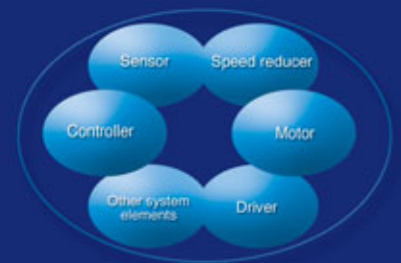

General Catalog

Harmonic Drive Gearing & Motion Control



Total Motion Control

Excellent Technology Clusters in a Wide Range of Industries

Harmonic drive products are unique precision speed reducers playing important roles in robots, semiconductor manufacturing systems, factory automation equipment and furthermore, in aerospace equipment that may convey our human dreams.

A variety of electromechanical products required high precision motion control in optical measuring equipment, medical equipment, printing machines and other systems offer many advantages in the field of industrial and scientific technologies.

Harmonic Drive LLC is making every efforts to develop supportive technologies for the 21st century, thereby contributing to global technological advance.

Harmonic Drive Gearing

Features

High positioning accuracy, High repeatability Compactness, Light weight, High reduction ratio, High torque capacity, Non-backlash, High efficiency, Quiet operation

Structure

Driven by a unique operating principle applying elastodynamics of metals and comprising of only three basic parts (Wave generator, Flexspline and Circular spline), Harmonic Drive products reveal excellent features not found in other speed reducers.

Structure of Harmonic Drive Unit (Component Type)

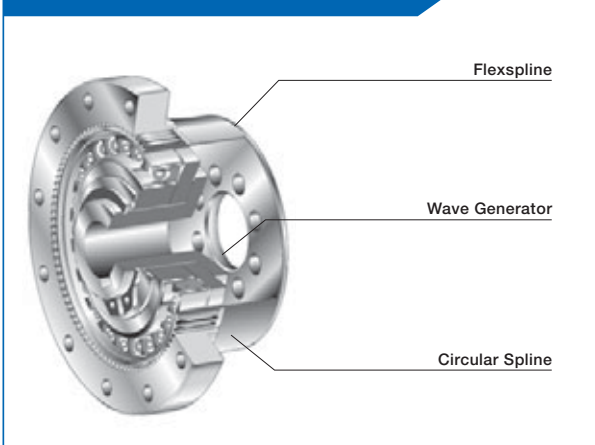

Wave Generator

The Wave Generator is a thin raced ball bearing fitted onto an elliptical hub serving as a high efficiency torque converter and generally mounted onto the input shaft.

Flexspline

The Flexspline is a non-rigid, thin cylindrical cup with external teeth on a slightly smaller pitch diameter than the Circular Spline. It fits over and is held in an elliptical shape by the Wave Generator.

Circular Spline

The Circular Spline is a rigid ring with internal teeth, engaging the teeth of the Flexspline across the major axis of the Wave Generator. The Circular Spline has two more teeth than the Flexspline and is generally mounted onto a housing.

Operating Principle

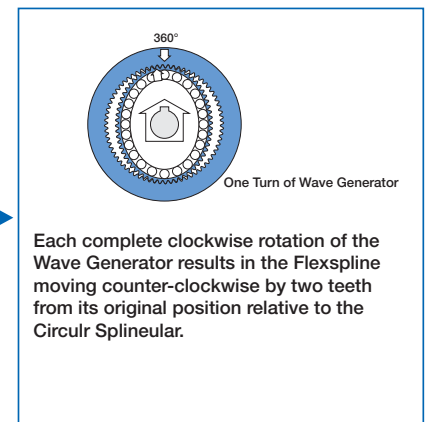
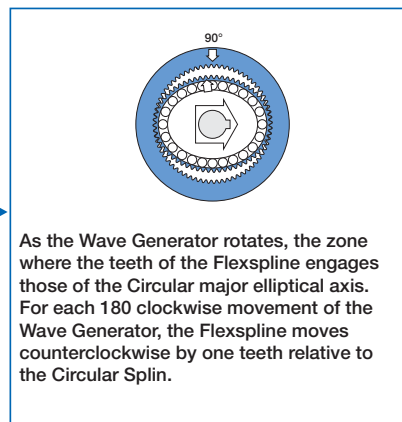
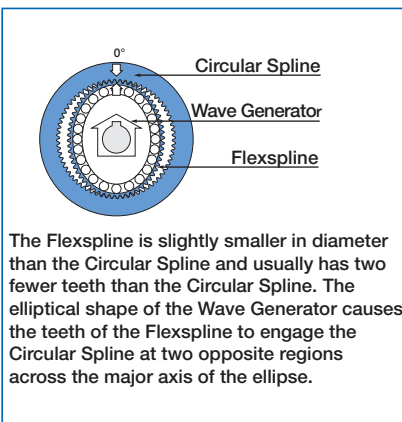

Tooth behavior and engagement

Unlike motions of ordinary gearing, the unique tooth behavior (operating principle) of harmonic drive gearing achieved non-backlash motion, infinitesimal angular feeding (one-pulse feeding) and high positioning repeatability. More than 30% of all teeth simultaneously engages in two locations in 180° symmetry, thereby allowing high torque capability.

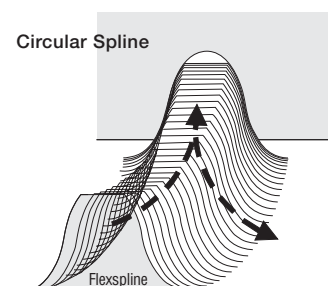

Product Lineup

Series

Drive System

Speed Reducers

Harmonic Drive Gearing

HarmonicDrive Precision Control Speed Reducers

Component / Cup Type

Cup Type

High-torque Type

CSG

Super Flat Type

CSD

Standard Type

CSF

Silk Hat Type

High-torque Type

SHG

Standard Type

SHF

Pancake Type

Standard Type

HDUF

Standard Type

HDUR

Unit Type

High-torque Type

CSG-2UH

Standard Type

CSG-2UH

High-Torque Hollow Shaft Type

SHG-2UH

Hollow Shaft Type

SHF-2UH

High-Torque Shaft Input Type

SHG-2UJ

Shaft Input Type

SHG-2UJ

Compact Double Shaft Type

CSF-1U

Simple Unit Type

High-torque Hollow Shaft Type

SHG-2SH

Flat Hollow Shaft Type

SHG-2SH

High-torque Flat Type

SHG-2SO

Flat Type

SHF-2SO

Super Flat Hollow Shaft Type

SHD-2SH

Phase Adjustment Unit

Standard Type

FD

Gear Head Type

Small and Medium-capacity Type

CSF-GH

Small Capacity Type

CSF-2XH

Gear Head Type

Small and Medium-capacity Type

HPG

Small-capacity Type

HP-F

Planetary Gearing Speed Reducers



Product Feature

Variation		Torque-weight Ratio	Torsional Stiffness	Positioning Accuracy	Lightweight	Flat Shape	Hollow Structure	Customizing	Life	Page in Catalog
Peak Torque (Nm)	Reduction Ratio									
23~3400	1/50~1/160	★★★★	★★★★	★★★★	★★	★★	★	★★★★	★★★★	10
12~820	1/50~1/160	★★★★	★★	★★	★★★★	★★★★	★★	★★★★	★★	11
1.8~9200	1/30~1/160	★★	★★★★	★★★★	★★	★★	★	★★★★	★★	12
23~3400	1/50~1/160	★★★★	★★★★	★★★★	★★	★★	★★★★	★★★★	★★★★	13
9.0~800	1/30~1/160	★★	★★★★	★★★★	★★	★★	★★★★	★★★★	★★	14
7.8~330	1/50~1/160	★	★	★	★★★★	★★★★	★★★★	★★★★	★	21
9.8~4000	1/50~1/320	★	★	★	★	★	★★★★	★★★★	★	21

Variation		Torque-weight Ratio	Moment Stiffness	Positioning Accuracy	Lightweight	Flat Shape	Hollow Structure	Customizing	Life	Page in Catalog
Peak Torque (Nm)	Reduction Ratio									
23~3400	1/50~1/160	★★★★	★★	★★★★	★★	★★	★	★★	★★	15
9.0~2600	1/30~1/160	★★	★★	★★★★	★★	★★	★	★★	★★	16
23~3400	1/50~1/160	★★★★	★★★★	★★★★	★	★	★★★★	★★★★	★★★★	17
9.0~1800	1/30~1/160	★★	★★★★	★★★★	★	★	★★★★	★★★★	★★	18
23~3400	1/50~1/160	★★★★	★★★★	★★★★	★	★	—	★★★★	★★★★	17
9.0~1800	1/30~1/160	★★	★★★★	★★★★	★	★	—	★★★★	★★	18
0.5~28	1/30~1/100	★★	★	★★★★	★★★★	★★★★	—	★★★★	★★	19

Variation		Torque-weight Ratio	Moment Stiffness	Positioning Accuracy	Lightweight	Flat Shape	Hollow Structure	Customizing	Life	Page in Catalog
Peak Torque (Nm)	Reduction Ratio									
23~3400	1/50~1/160	★★★★	★★★★	★★★★	★★	★★	★★★★	★★	★★★★	18
9.0~1800	1/30~1/160	★★	★★★★	★★★★	★★	★★	★★★★	★★	★★	17
23~3400	1/50~1/160	★★★★	★★★★	★★★★	★★	★★	—	★★	★★★★	18
9.0~1800	1/30~1/160	★★	★★★★	★★★★	★★	★★	—	★★	★★	17
12~450	1/50~1/160	★★★★	★★	★★★★	★★★★	★★★★	★★★★	★★	★★	20

Variation		Torque-weight Ratio	Torsional Stiffness	Positioning Accuracy	Lightweight	Flat Shape	Hollow Structure	Customizing	Life	Page in Catalog
Peak Torque (Nm)	Reduction Ratio									
30~4000	1/50~1/320	★	★	★	★	★	★★★★	★★	★	21

Variation			Moment Stiffness	Positioning Accuracy	Lightweight	Compactness	Backlash	Ease of Mounting	Life	Page in Catalog
Peak Torque (Nm)	Reduction Ratio	Motor Capacity (W)								
18~2600	1/50~1/160	30~5000	★★★★	★★★★	★★	★	★★★★	★★★★	★★	22
0.5~28	1/30~1/100	3~30	★	★★★★	★★★★	★★★★	★★★★	★★	★★	19
23~850	1/5~1/45	30~10000	★★★★	★★	★★	★	★★	★★	★★★★	23
2.5~5.2	1/5~1/25	5~30	★	★	★★★★	★★★★	★	★★	★★★★	24



Series

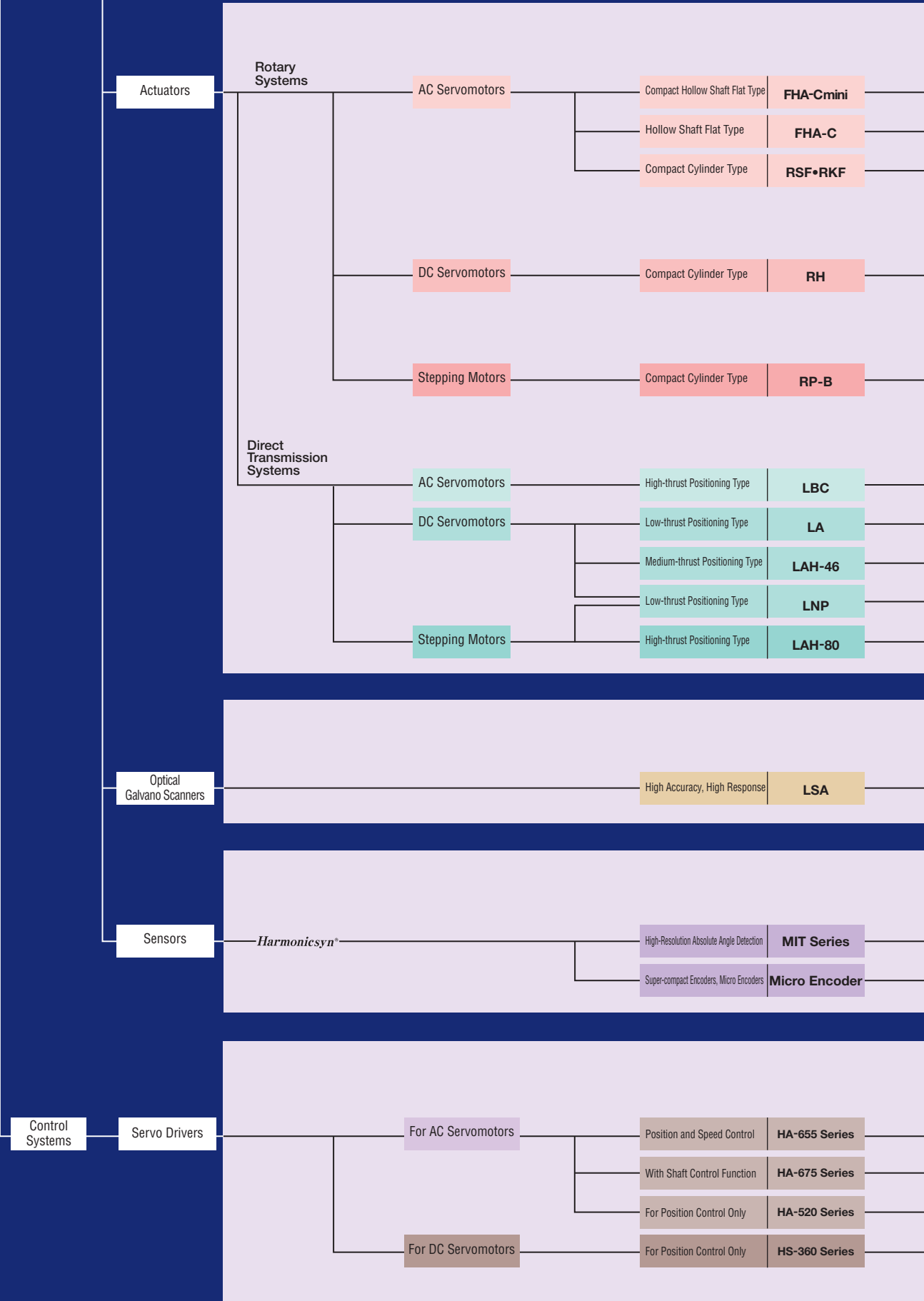

Actuators

Rotary Systems

AC Servomotors

Compact Hollow Shaft Flat Type

FHA-Cmini

Hollow Shaft Flat Type

FHA-C

Compact Cylinder Type

RSF•RKF

DC Servomotors

Compact Cylinder Type

RH

Stepping Motors

Compact Cylinder Type

RP-B

Direct Transmission Systems

AC Servomotors

High-thrust Positioning Type

LBC

DC Servomotors

Low-thrust Positioning Type

LA

Medium-thrust Positioning Type

LAH-46

Low-thrust Positioning Type

LNP

Stepping Motors

High-thrust Positioning Type

LAH-80

Optical Galvano Scanners

High Accuracy, High Response

LSA

Sensors

*Harmonicsyn**

High-Resolution Absolute Angle Detection

MIT Series

Super-compact Encoders, Micro Encoders

Micro Encoder

Control Systems

Servo Drivers

For AC Servomotors

Position and Speed Control

HA-655 Series

With Shaft Control Function

HA-675 Series

For Position Control Only

HA-520 Series

For DC Servomotors

For Position Control Only

HS-360 Series

Product Feature

Variation		Repeatability	Resolution	Moment Stiffness	Servo Performance	Hollow Structure	Thinness	Compactness	Lightweight	Page in Catalog
Peak Torque (Nm)	Maximum Speed (rpm)									
1.8~28	200~60	★★★★	★★★★	★★★★	★★	★★★★	★★★★	★★★★	★★	25
39~690	96~35	★★★★	★★★★	★★★★	★★	★★★★	★★★★	★★★★	★★	26
1.5~330	30~60	★★	★★	★★	★★	—	★	★★★★	★★★★	27

Variation		Repeatability	Resolution	Moment Stiffness	Servo Performance	Hollow Structure	Thinness	Compactness	Lightweight	Page in Catalog
Peak Torque (Nm)	Maximum Speed (rpm)									
0.39~20	180~50	★★	★	★★	★★★★	—	—	★★★★	★★	28

Variation		Repeatability	Resolution	Moment Stiffness	Servo Performance	Hollow Structure	Thinness	Compactness	Lightweight	Page in Catalog
Peak Torque (Nm)	Maximum Speed (rpm)									
8.3~54	35~70	★★	★★★★	★★	—	—	—	★★	★	29

Variation			Repeatability	Resolution	Stiffness	Compactness	Lightweight	Page in Catalog
Maximum Driving Force (N)	Maximum Speed (mm/s)	Stroke (mm)						
6000~12000	6000~12000	10~20	★★	★★★★	★★★★	★★★★	★★★★	30
49	49	0.9~10	★★	★★★★	★★	★★★★	★★★★	30
392	392	0.9~10	★★	★★★★	★★	★★★★	★★★★	30
10kg	1.5	13~15	★★	★★★★	★★	★★★★	★★★★	30
3000	3000	0.9~10	★★	★★★★	★★	★★★★	★★★★	30

Moment of Inertia (g·cm)	Torque Constant (N·m/A)	Repeatability	Linearity	Stiffness	Servo Performance	Drift Characteristic	Compactness	Lightweight	Page in Catalog
1.8~8.5	0.0082~0.05	★★★★	★★★★	★★★★	★★★★	★★★★	★★	★★★★	31

Compatibility to Host Computer	Absolute Detection System	Incremental System	Robustness	Super Long Life	Resolution	Compactness	Lightweight	Page in Catalog
★★★★	○	—	★★★★	★★★★	★★★★	★	★	32
★★	—	○	★	★	★★	★★★★	★★★★	33

Valve Position Command	Analog Speed Command	Mono-shaft Control (Command)	Interface to Absolute	Interface to Incremental	International Safety Standard	Functional Versatility	Display Function	Page in Catalog
○	○	—	○	○	CE,UL	★★★★	★★★★	34
—	—	○	○	○	CE,UL	★★	★★★★	34
○	—	—	—	○	—	★★	★★	34
○	—	—	—	○	—	★★	★★	34

The combinations with actuator and driver may not fully be complied with foreign safety standards. Please contact our sales office.

Harmonic Drive Gearing



CSG (P10)



CSD (P11)



CSF (P12)



SHF (P14)
SHG (P13)

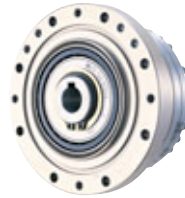

CSG-2UH (P15)



CSF-2UH (P16)



SHF-2UH (P18)
SHG-2UH (P17)

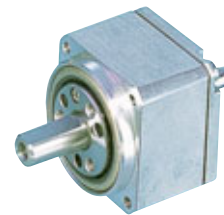

CSF-1U (P19)



SHD-2SH (P20)



HDUF (P21)



HDUR (P21)



HDB (P22)



HDT (P23)

Gear Head Type



CSF-GH (P24)



HPG (P25)



Infinit-Indexer (P26)

Rotary Servo Actuators



FHA-C mini (P27)



FHA-C (P28)



Powerhub (P29)



RSF (P30)



RH (P30)



RHS-25 (P32)
RFS-25 (P32)



HHA Chamberlink™ (P33)



LPA (P34)



LBC (P36)



LA (P36)



LAH-46 (P36)

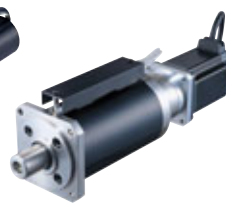

LAH-80 (P36)

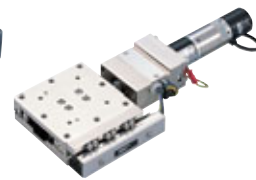

LNP (P36)

Optical Galvano Scanners



LSA (P37)

Sensors

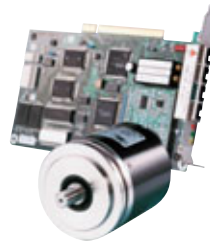

MIT (P38)



Micro Encoder (P39)

Servo Drivers



HA-655 HA-675 (P40)



HA-520 (P40)



HS-360 (P40)

CSG Series

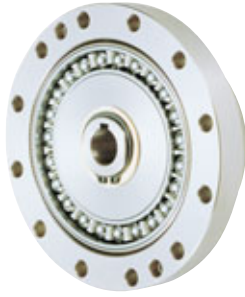

- Compact and simple design
- High torque capacity
- High stiffness
- Non-backlash
- High positioning and rotational accuracies

To realize a high load capacity and high reliability, the torque capacity has been increased by 30%. Units that allow easy mounting are also available. (See page 15.)

Life : 10,000h

Comparison of Features. High Torque Harmonic Drive vs. CSG Series

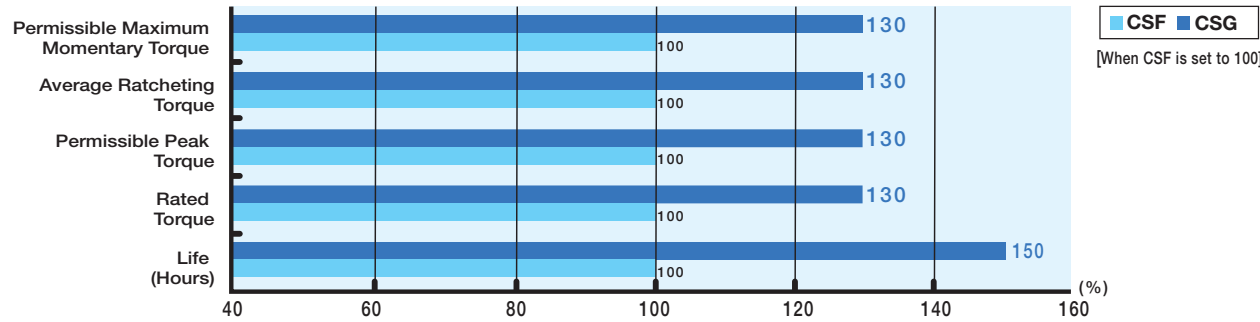

•CSG Series Ratings

Item Model No.	Reduction Ratio	Rated Torque at 2000rpm		Permissible Peak Torque at Start and Stop		Permissible Maximum Momentary Torque	
		N·m	kgf·m	N·m	kgf·m	N·m	kgf·m
14	50	7.0	0.7	23	2.3	6	4.7
	80	10	1.0	30	3.1	61	6.2
	100	10	1.0	36	3.7	70	7.2
17	50	21	2.1	44	4.5	91	9
	80	29	2.9	56	5.7	113	12
	100	31	3.2	70	7.2	143	15
20	50	33	3.3	73	7.4	127	13
	80	44	4.5	96	9.8	165	17
	100	52	5.3	107	10.9	191	20
25	50	51	5.2	127	13	242	25
	80	82	8.4	178	18	332	34
	100	87	8.9	204	21	369	38
32	50	99	10	281	29	497	51
	80	153	16	395	40	738	75
	100	178	18	433	44	841	86

Item Model No.	Reduction Ratio	Rated Torque at 2000rpm		Permissible Peak Torque at Start and Stop		Permissible Maximum Momentary Torque	
		N·m	kgf·m	N·m	kgf·m	N·m	kgf·m
40	50	178	18	523	53	92	91
	80	268	27	675	69	1270	130
	100	345	35	738	75	1400	143
	120	382	39	802	82	1530	156
45	50	229	23	650	66	1235	126
	80	407	41	918	94	1651	168
	100	459	47	982	100	2041	208
	120	523	53	1070	109	2288	233
50	50	229	23	650	66	1235	126
	80	407	41	918	94	1651	168
	100	459	47	982	100	2041	208
	120	523	53	1070	109	2288	233
58	50	229	23	650	66	1235	126
	80	484	49	1223	125	2418	247
	100	611	62	1274	130	2678	273
	120	688	70	1404	143	2678	273
65	50	229	23	650	66	1235	126
	80	714	73	1924	196	3185	325
	100	905	92	2067	211	4134	422
	120	969	99	2236	228	4329	441

Main Application Target

- Robots
- Humanoid robots
- Metal machine tools

- Printing, bookbinding and paper processing machines
- Wood, light metal and plastic working machines
- Printed circuit board manufacturing machines

**Please contact
Harmonic Drive LLC
for a detailed
catalog of this
product.**

CSD Series



- Super thin
- Hollow structure
- High repeatability

Responding to the market needs, seven models of the new Harmonic Drive CSD series have been succeeded in downsizing. The CSD series is designed for applications requiring ultra compact size.

Life : 7,000h

•CSD Series Ratings

Model No.	Item	Reduction Ratio	Rated Torque at 2000rpm		Peak Torque at Start and Stop		Permissible Maximum Momentary Torque	
			N·m	kgf·m	N·m	kgf·m	N·m	kgf·m
14		50	3.7	0.38	12	1.2	24	2.4
		100	5.4	0.55	19	1.9	31	3.2
17		50	11	1.1	23	2.3	48	4.9
		100	16	1.6	37	3.8	55	5.6
20		50	17	1.7	39	4.0	69	7.0
		100	28	2.9	57	5.8	76	7.7
		160	28	2.9	64	6.5	76	7.7
25		50	27	2.8	69	7.0	127	13
		100	47	4.8	110	11	152	15
		160	47	4.8	123	13	152	15
32		50	53	5.4	151	15	268	27
		100	96	10	233	24	359	37
		160	96	10	261	27	359	37
40		50	96	10	281	29	480	49
		100	185	19	398	41	694	71
		160	206	21	453	46	694	71
50		50	172	18	500	51	1000	102
		100	329	34	686	70	1440	147
		160	370	38	823	84	1577	161

Main Application Target

- Robots
- Humanoid robots
- Aerospace

**Please contact
Harmonic Drive LLC
for a detailed
catalog of this
product.**

CSF Series

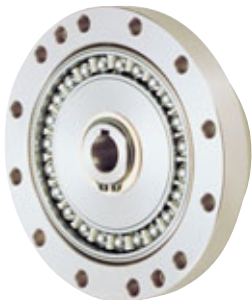

- Compact
- High torque capacity
- High stiffness
- Non-backlash
- High positioning and rotational accuracies
- Coaxial input and output

For downsizing purpose, the axial length has been reduced to about one half. Units that allow easy mounting are also available. (See page 16.)

Life : 7,000h

•CSF Series Ratings

Item Model No.	Reduction Ratio	Rated Torque at 2000rpm		Permissible Peak Torque at Start and Stop		Permissible Maximum Momentary Torque	
		N•m	kgf•m	N•m	kgf•m	N•m	kgf•m
8	30 0.	9	0.09	1.8	0.18	3.3	0.34
	50	1.8	0.18	3.3	0.34	6.6	0.67
	100	2.4	0.25	4.8	0.49	9.0	0.92
11	30	2.2	0.22	4.5	0.46	8.5	0.87
	50	3.5	0.36	8.3	0.85	17	1.7
	100	5.0	0.51	11	1.1	25	2.6
14	30	4.0	0.41	9.0	0.92	17	1.7
	50	5.4	0.55	18	1.8	35	3.6
	80	7.8	0.80	23	2.4	47	4.8
	100	7.8	0.80	28	2.9	54	5.5
17	30	8.8	0.90	16	1.6	30	3.1
	50	16	1.6	34	3.5	70	7.1
	80	22	2.2	43	4.4	87	8.9
	100	24	2.4	54	5.5	108	11
20	120	24	2.4	54	5.5	86	8.8
	30	15	1.5	27	2.8	50	5.1
	50	25	2.5	56	5.7	98	10
	80	34	3.5	74	7.5	127	13
	100	40	4.1	82	8.4	147	15
25	120	40	4.1	87	8.9	147	15
	160	40	4.1	92	9.4	147	15
	30	27	2.8	50	5.1	95	9.7
	50	39	4.0	98	10	186	19
	80	63	6.4	137	14	255	26
	100	67	6.8	157	16	284	29
32	120	67	6.8	167	17	304	31
	160	67	6.8	176	18	314	32
	30	54	5.5	100	10	200	20
	50	76	7.8	216	22	382	39
	80	118	12	304	31	568	58
40	100	137	14	333	34	647	66
	120	137	14	353	36	686	70
	160	137	14	372	38	686	70
	50	137	14	402	41	686	70
40	80	206	21	519	53	980	100
	100	265	27	568	58	1080	110
	120	294	30	617	63	1180	120
	160	294	30	647	66	1180	120

Item Model No.	Reduction Ratio	Rated Torque at 2000rpm		Permissible Peak Torque at Start and Stop		Permissible Maximum Momentary Torque	
		N•m	kgf•m	N•m	kgf•m	N•m	kgf•m
45	50	176	18	500	51	950	97
	80	313	32	706	72	1270	130
	100	353	36	755	77	1570	160
	120	402	41	823	84	1760	180
	160	402	41	882	90	1910	195
50	50	245	25	715	73	1430	146
	80	372	38	941	96	1860	190
	100	470	48	980	100	2060	210
	120	529	54	1080	110	2060	210
	160	529	54	1180	120	2450	250
58	50	353	36	1020	104	1960	200
	80	549	56	1480	151	2450	250
	100	696	71	1590	162	3180	325
	120	745	76	1720	176	3330	340
	160	745	76	1840	188	3430	350
65	50	490	50	1420	145	2830	289
	80	745	76	2110	215	3720	380
	100	951	97	2300	235	4750	485
	120	951	97	2510	256	4750	485
	160	951	97	2630	268	4750	485
80	50	872	89	2440	249	4870	497
	80	1320	135	3430	350	6590	672
	100	1700	173	4220	431	7910	807
	120	1990	203	4590	468	7910	807
	160	1990	203	4910	501	7910	807
90	50	1180	120	3530	360	6660	680
	80	1550	158	3990	407	7250	740
	100	2270	232	5680	580	9020	920
	120	2570	262	6160	629	9800	1000
100	160	2700	276	6840	698	11300	1150
	50	1580	161	4450	454	8900	908
	80	2380	243	6060	618	11600	1180
	100	2940	300	7350	750	14100	1440
100	120	3180	324	7960	812	15300	1560
	160	3550	362	9180	937	15500	1580

Main Application Target

- Robots
- Humanoid robots
- Metal machine tools
- Printing, bookbinding and paper processing machines
- Semiconductor manufacturing systems
- Measurement, analytical and test systems
- Medical equipment
- Optical machines
- Telescopes
- Wood, light metal and plastic working machines
- Energy
- Paper-making machines
- Crating and packaging machines
- Flat panel display manufacturing systems
- Printed circuit board manufacturing machines
- Space equipment
- Aircraft
- Glass and ceramic manufacturing systems

**Please contact
Harmonic Drive LLC
for a detailed
catalog of this
product.**

SHG Series



- Large bore with hollow hole, flat shape
- Non-backlash
- Excellent positioning and rotational accuracies
- Coaxial input and output shaft
- Compact and simple design
- High torque capacity
- High stiffness

To realize a high load capacity and high reliability, the torque capacity has been increased

Life : 10,000h

•Comparison of Features. High Torque Harmonic Drive vs. CSF Series

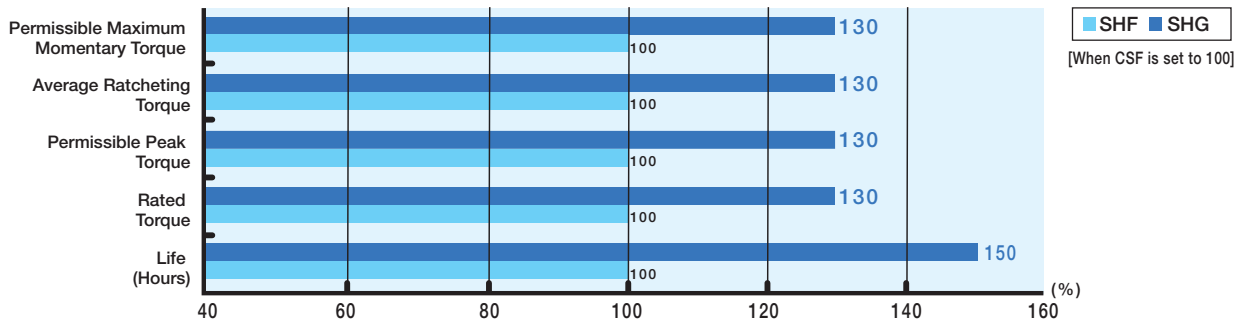

•SHG Series Ratings

Item Model No.	Reduction Ratio	Rated Torque at 2000rpm		Permissible Peak Torque at Start and Stop		Permissible Maximum Momentary Torque	
		N•m	kgf•m	N•m	kgf•m	N•m	kgf•m
14	50	7.0	0.7	23	2.3	46	4.7
	80	10	1.0	30	3.1	61	6.2
	100	10	1.0	36	3.7	70	7.2
17	50	21	2.1	44	4.5	91	9
	80	29	2.9	56	5.7	113	12
	100	31	3.2	70	7.2	143	15
20	120	31	3.2	70	7.2	112	11
	50	33	3.3	73	7.4	127	13
	80	44	4.5	96	9.8	165	17
	100	52	5.3	107	10.9	191	20
25	120	52	5.3	113	11.5	191	20
	160	52	5.3	120	12.2	191	20
	50	51	5.2	127	13	242	25
	80	82	8.4	178	18	332	34
32	100	87	8.9	204	21	369	38
	120	87	8.9	217	22	395	40
	160	87	8.9	229	23	408	42
	50	99	10	281	29	497	51
40	80	153	16	395	40	738	75
	100	178	18	433	44	841	86
	120	178	18	459	47	892	91
	160	178	18	484	49	892	91
45	50	178	18	523	53	892	91
	80	268	27	675	69	1270	130
	100	345	35	738	75	1400	143
	120	382	39	802	82	1530	156
50	160	382	39	841	86	1530	156
	50	229	23	650	66	1235	126
	80	407	41	918	94	1651	168
	100	459	47	982	100	2041	208
58	120	523	53	1070	109	2288	233
	160	523	53	1147	117	2483	253
	80	484	49	1223	125	2418	247
	100	611	62	1274	130	2678	273
65	120	688	70	1404	143	2678	273
	160	688	70	1534	156	3185	325
	80	714	73	1924	196	3185	325
	100	905	92	2067	211	4134	422
65	120	969	99	2236	228	4329	441
	160	969	99	2392	244	4459	455
	80	969	99	2743	280	4836	493
	100	1236	126	2990	305	6175	630
65	120	1236	126	3263	333	6175	630
	160	1236	126	3419	349	6175	630

Main Application Target

- Robots
- Humanoid robots
- Metal machine tools
- Metal working machines
- Printing, bookbinding and paper processing machines
- Wood, light metal and plastic machine tools
- Printed circuit board manufacturing machines

**Please contact
Harmonic Drive LLC
for a detailed
catalog of this
product.**

SHF Series



- Large bore with hollow hole, flat shape
- Compact and simple design
- Non-backlash
- High torque capacity
- High positioning and rotational accuracies
- High stiffness
- Coaxial input and output shaft

To minimize the space of machines and systems and for a total cost reduction, the SHF series has achieved a large bore with hollow hole and flat shape. Units that allow easy mounting are also available. (See page 18.)

Life : 7,000h

•SHF Series Ratings

Item Model No.	Reduction Ratio	Rated Torque at 2000rpm		Permissible Peak Torque at Start and Stop		Permissible Maximum Momentary Torque	
		N·m	kgf·m	N·m	kgf·m	N·m	kgf·m
14	30	4.0	0.41	9.0	0.92	17	1.7
	50	5.4	0.55	18	1.8	35	3.6
	80	7.8	0.80	23	2.4	47	4.8
	100	7.8	0.80	28	2.9	54	5.5
17	30	8.8	0.90	16	1.6	30	3.1
	50	16	1.6	34	3.5	70	7.1
	80	22	2.2	43	4.4	87	8.9
	100	24	2.4	54	5.5	110	11
20	120	24	2.4	54	5.5	86	8.8
	30	15	1.5	27	2.8	50	5.1
	50	25	2.5	56	5.7	98	10
	80	34	3.5	74	7.5	127	13
25	100	40	4.1	82	8.4	147	15
	120	40	4.1	87	8.9	147	15
	160	40	4.1	92	9.4	147	15
	30	27	2.8	50	5.1	95	9.7
32	50	39	4.0	98	10.1	86	19
	80	63	6.4	137	14	255	26
	100	67	6.8	157	16	284	29
	120	67	6.8	167	17	304	31
32	160	67	6.8	176	18	314	32
	30	54	5.5	100	10	200	20
	50	76	7.8	216	22	382	39
	80	118	12	230	31	568	58
32	100	137	14	333	34	647	66
	120	137	14	353	36	686	70
	160	137	14	372	38	686	70

Item Model No.	Reduction Ratio	Rated Torque at 2000rpm		Permissible Peak Torque at Start and Stop		Permissible Maximum Momentary Torque	
		N·m	kgf·m	N·m	kgf·m	N·m	kgf·m
40	50	137	14	402	41	686	70
	80	206	21	519	53	980	100
	100	265	27	568	58	1080	110
	120	294	30	617	63	1180	120
	160	294	30	647	66	1180	120
45	50	176	18	500	51	950	97
	80	313	32	706	72	1270	130
	100	353	36	755	77	1570	160
	120	402	41	823	84	1760	180
50	160	402	41	882	90	1910	195
	50	245	25	715	73	1430	146
	80	372	38	941	96	1860	190
	100	470	48	980	100	2060	210
50	120	529	54	1080	110	2060	210
	160	529	54	1180	120	2450	250
	50	353	36.1	1020	104	1960	200
	80	549	56	1480	151	2450	250
58	100	696	71	1590	162	3180	325
	120	745	76	1720	176	3330	340
	160	745	76	1840	188	3430	350

Main Application Target

- Robots
- Humanoid robots
- Metal machine tools
- Metal working machines
- Printing, bookbinding and paper processing machines
- Semiconductor manufacturing systems
- Measurement, analytical and test systems
- Medical equipment
- Optical machines
- Crating and packaging machines
- Flat panel display manufacturing systems
- Printed circuit board manufacturing machines
- Space equipment
- Glass and ceramic manufacturing systems
- Telescopes
- Wood, light metal and plastic machine tools
- Paper-making machines

**Please contact
Harmonic Drive LLC
for a detailed
catalog of this
product.**

CSG Series

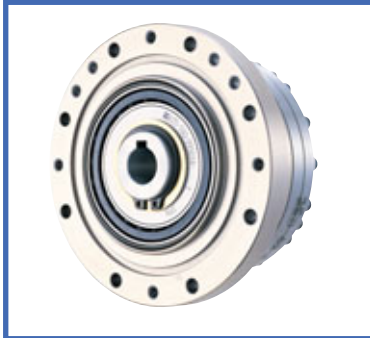

- High torque capacity
- High stiffness
- Compact and simple design
- Non-backlash
- High positioning and rotational accuracies
- Coaxial input and output

To realize of a high load capacity and high reliability, the torque capacity has been increased by 30%.

Life : 10,000h

•CSG Series Ratings

Item Model No.	Reduction Ratio	Rated Torque at 2000rpm		Permissible Peak Torque at Start and Stop		Permissible Maximum Momentary Torque	
		N-m	kgf-m	N-m	kgf-m	N-m	kgf-m
14	50	7.0	0.7	23	2.3	46	4.7
	80	10	1.0	30	3.1	61	6.2
	100	10	1.0	36	3.7	70	7.2
17	50	21	2.1	44	4.5	91	9
	80	29	2.9	56	5.7	113	12
	100	31	3.2	70	7.2	143	15
20	50	33	3.3	73	7.4	127	13
	80	44	4.5	96	9.8	165	17
	100	52	5.3	107	10.9	191	20
25	50	51	5.2	127	13	242	25
	80	82	8.4	178	18	332	34
	100	87	8.9	204	21	369	38
32	50	99	10	281	29	497	51
	80	153	16	395	40	738	75
	100	178	18	433	44	841	86

Item Model No.	Reduction Ratio	Rated Torque at 2000rpm		Permissible Peak Torque at Start and Stop		Permissible Maximum Momentary Torque	
		N-m	kgf-m	N-m	kgf-m	N-m	kgf-m
40	50	178	18	523	53	892	91
	80	268	27	675	69	1270	130
	100	345	35	738	75	1400	143
	120	382	39	802	82	1530	156
45	50	229	23	650	66	1235	126
	80	407	41	918	94	1651	168
	100	459	47	982	100	2041	208
	120	523	53	1070	109	2288	233
50	50	229	23	650	66	1235	126
	80	407	41	918	94	1651	168
	100	459	47	982	100	2041	208
	120	523	53	1070	109	2288	233
58	50	229	23	650	66	1235	126
	80	407	41	918	94	1651	168
	100	459	47	982	100	2041	208
	120	523	53	1070	109	2288	233
65	50	229	23	650	66	1235	126
	80	407	41	918	94	1651	168
	100	459	47	982	100	2041	208
	120	523	53	1070	109	2288	233

•Cross Roller Bearing Specification

Item Model No.	Basic Rated Load				Permissible Moment Load Mc		Moment Stiffness Km	
	Basic Dynamic Rated Load C		Basic Static Rated Load Co		N-m	kgf-m	×10 ⁴ N-m/rad	kgf-m/arc-min
14	47	480	60.7	620	41	4.2	4.38	1.3
17	52.9	540	75.5	770	64	6.5	7.75	2.3
20	57.8	590	90.0	920	91	9.3	12.8	3.8
25	96.0	980	151	1540	156	16	24.2	7.2
32	150	1530	250	2550	313	32	53.9	16
40	213	2170	365	3720	450	46	91.0	27
45	230	2350	426	4340	686	70	141	42
50	348	3550	602	6140	759	77	171	51
58	518	5290	904	9230	1180	120	283	84
65	556	5670	1030	10500	1860	190	404	120

- "Basic dynamic rated load" is a constant stationary radial load that achieves a basic dynamic rated life of the bearing of one million revolutions.
- "Basic static rated load" is a static load that achieves a contact stress of a constant level (4kN/mm²) at the center of a contact zone between the rolling element receiving a maximum load and track.
- The moment stiffnesses are mean values.

Main Application Target

- Robots
- Humanoid robots
- Metal machine tools
- Printing, bookbinding and paper processing machines
- Wood, light metal and plastic machine tools
- Printed circuit board manufacturing machines

**Please contact
Harmonic Drive LLC
for a detailed
catalog of this
product.**

Unit/Standard Type
CSF Series

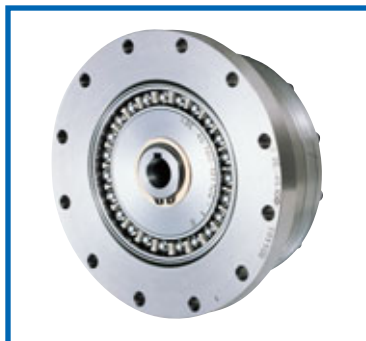

- Compact and simple design
- High torque capacity
- High stiffness
- Non-backlash
- High positioning and rotational accuracies
- Coaxial input and output

To meet with minimum space requirement, the axial length has been reduced to about one half.

Life : 7,000h

•CSF Series Ratings

Item Model No.	Reduction Ratio	Rated Torque at 2000rpm		Permissible Peak Torque at Start and Stop		Permissible Maximum Momentary Torque	
		N·m	kgf·m	N·m	kgf·m	N·m	kgf·m
14	30	4.0	0.41	9.0	0.92	17	1.7
	50	5.4	0.55	18	1.8	35	3.6
	80	7.8	0.80	23	2.4	47	4.8
	100	7.8	0.8	28	2.9	54	5.5
17	30	8.8	0.90	16	1.6	30	3.1
	50	16	1.6	34	3.5	70	7.1
	80	22	2.2	43	4.4	87	8.9
	100	24	2.4	54	5.5	108	11
20	120	24	2.4	54	5.5	86	8.8
	30	15	1.5	27	2.8	50	5.1
	50	25	2.5	56	5.7	98	10
	80	34	3.5	74	7.5	127	13
25	100	40	4.1	82	8.4	147	15
	120	40	4.1	87	8.9	147	15
	160	40	4.1	92	9.4	147	15
	30	27	2.8	50	5.1	95	9.7
32	50	39	4.0	98	10	186	19
	80	63	6.4	137	14	255	26
	100	67	6.8	157	16	284	29
	120	67	6.8	167	17	304	31
40	160	67	6.8	176	18	314	32
	30	54	5.5	100	10	200	20
	50	76	7.8	216	22	382	39
	80	118	12	304	31	568	58
50	100	137	14	333	34	647	66
	120	137	14	353	36	686	70
	160	137	14	372	38	686	70

Item Model No.	Reduction Ratio	Rated Torque at 2000rpm		Permissible Peak Torque at Start and Stop		Permissible Maximum Momentary Torque	
		N·m	kgf·m	N·m	kgf·m	N·m	kgf·m
40	50	137	14	402	41	686	70
	80	206	21	519	53	980	100
	100	265	27	568	58	1080	110
	120	294	30	617	63	1180	120
45	160	294	30	647	66	1180	120
	50	176	18	500	51	950	97
	80	313	32	706	72	1270	130
	100	353	36	755	77	1570	160
50	120	402	41	823	84	1760	180
	160	402	41	882	90	1910	195
	50	245	25	715	73	1430	146
	80	372	38	941	96	1860	190
58	100	470	48	980	100	2060	210
	120	529	54	1080	110	2060	210
	160	529	54	1180	120	2450	250
	50	353	36	1020	104	1960	200
65	80	549	56	1480	151	2450	250
	100	696	71	1590	162	3180	325
	120	745	76	1720	176	3330	340
	160	745	76	1840	188	3430	350
65	50	490	50	1420	145	2830	289
	80	745	76	2110	215	3720	380
	100	951	97	2300	235	4750	485
	120	951	97	2510	256	4750	485
160	951	97	2630	268	4750	485	

•Cross Roller Bearing Specification

Item Model No.	Basic Rated Load				Permissible Moment Load Mc		Moment Stiffness Km	
	Basic Dynamic Rated Load C		Basic Static Rated Load Co		N·m	kgf·m	×10 ⁴ N·m/rad	kgf·m/arc-min
	×10 ² N	kgf	×10 ² N	kgf				
14	47	480	60.7	620	41	4.2	4.38	1.3
17	52.9	540	75.5	770	64	6.5	7.75	2.3
20	57.8	590	90.0	920	91	9.3	12.8	3.8
25	96.0	980	151	1540	156	16	24.2	7.2
32	150	1530	250	2550	313	32	53.9	16
40	213	2170	365	3720	450	46	91.0	27
45	230	2350	426	4340	686	70	141	42
50	348	3550	602	6140	759	77	171	51
58	518	5290	904	9230	1180	120	283	84
65	556	5670	1030	10500	1860	190	404	120

- "Basic dynamic rated load" is a constant stationary radial load that achieves a basic dynamic rated life of the bearing of one million revolutions.
- "Basic static rated load" is a static load that achieves a contact stress of a constant level (4kN/mm²) at the center of a contact zone between the rolling element receiving a maximum load and track.
- The moment stiffnesses are mean values.

Main Application Target

- Robots
- Humanoid robots
- Metal machine tools
- Printing, bookbinding and paper processing machines
- Semiconductor manufacturing systems
- Measurement, analytical and test systems
- Medical equipment
- Optical machines
- Telescopes
- Wood, light metal and plastic machine tools
- Energy
- Paper-making machines
- Crating and packaging machines
- Flat panel display manufacturing systems
- Printed circuit board manufacturing machines
- Space equipment
- Aircraft
- Glass and ceramic manufacturing systems

Please contact
Harmonic Drive LLC
for a detailed
catalog of this
product.

SHG Series



- Large bore with hollow hole, flat shape
- Non-backlash
- High positioning and rotational accuracies
- Coaxial input and output
- Compact and simple design
- High torque capacity
- High stiffness

To realize a high load capacity and high reliability, the torque capacity has been increased by 30%.

Life : 10,000h

•SHG Series Ratings

Item Model No.	Reduction Ratio	Rated Torque at 2000rpm		Permissible Peak Torque at Start and Stop		Permissible Maximum Momentary Torque	
		N-m	kgf-m	N-m	kgf-m	N-m	kgf-m
14	50	7.0	0.7	23	2.3	46	4.7
	80	10	1.0	30	3.1	61	6.2
	100	10	1.0	36	3.7	70	7.2
17	50	21	2.1	44	4.5	91	9
	80	29	2.9	56	5.7	113	12
	100	31	3.2	70	7.2	143	15
20	120	31	3.2	70	7.2	112	11
	50	33	3.3	73	7.4	127	13
	80	44	4.5	96	9.8	165	17
	100	52	5.3	107	10.9	191	20
25	120	52	5.3	113	11.5	191	20
	160	52	5.3	120	12.2	191	20
	50	51	5.2	127	13	242	25
	80	82	8.4	178	18	332	34
32	100	87	8.9	204	21	369	38
	120	87	8.9	217	22	395	40
	160	87	8.9	229	23	408	42
	50	99	10	281	29	497	51
40	80	153	16	395	40	738	75
	100	178	18	433	44	841	86
	120	178	18	459	47	892	91
	160	178	18	484	49	892	91

Item Model No.	Reduction Ratio	Rated Torque at 2000rpm		Permissible Peak Torque at Start and Stop		Permissible Maximum Momentary Torque	
		N-m	kgf-m	N-m	kgf-m	N-m	kgf-m
40	50	178	18	523	53	892	91
	80	268	27	675	69	1270	130
	100	345	35	738	75	1400	143
	120	382	39	802	82	1530	156
45	160	382	39	841	86	1530	156
	50	229	23	650	66	1235	126
	80	407	41	918	94	1651	168
	100	459	47	982	100	2041	208
50	120	523	53	1070	109	2288	233
	160	523	53	1147	117	2483	253
	80	484	49	1223	125	2418	247
58	100	611	62	1274	130	2678	273
	120	688	70	1404	143	2678	273
	160	688	70	1534	156	3185	325
65	80	714	73	1924	196	3185	325
	100	905	92	2067	211	4134	422
	120	969	99	2236	228	4329	441
	160	969	99	2392	244	4459	455
65	80	969	99	2743	280	4836	493
	100	1236	126	2990	305	6175	630
	120	1236	126	3263	333	6175	630
	160	1236	126	3419	349	6175	630

•Cross Roller Bearing Specification

Item Model No.	Basic Rated Load				Permissible Moment Load Mc		Moment Stiffness Km	
	Basic Dynamic Rated Load C		Basic Static Rated Load Co					
	x 10 ² N	kgf	x 10 ² N	kgf	N-m	kgf-m	x 10 ⁴ N-rad	kgf-m/arc-min
14	58	590	86	880	74	7.6	8.5	2.5
17	104	1060	163	1670	124	12.6	15.1	4.6
20	146	1490	220	2250	187	19.1	25.2	7.5
25	218	2230	358	3660	258	26.3	39.2	11.6
32	382	3900	654	6680	580	59.1	100	29.6
40	433	4410	816	8330	849	86.6	179	53.2
45	776	7920	1350	13800	1127	115	257	76.3
50	816	8330	1490	15300	1487	152	351	104
58	874	8920	1710	17500	2180	222	531	158
65	1300	13300	2230	22700	2740	280	741	220

• "Basic dynamic rated load" is a constant stationary radial load that achieves a basic dynamic rated life of the bearing of one million revolutions.
 "Basic static rated load" is a static load that achieves a contact stress of a constant level (408kN/mm²) at the center of a contact zone between the rolling element receiving a maximum load and track.

Main Application Target

- Robots
- Humanoid robots
- Metal machine tools
- Metal working machines
- Printing, bookbinding and paper processing machines
- Wood, light metal and plastic machine tools
- Printed circuit board manufacturing machines

**Please contact
Harmonic Drive LLC
for a detailed
catalog of this
product.**

Unit/Hollow Shaft, Shaft Input Types
Simple Unit/Flat-hollow, Flat Types

SHF Series



- Large bore with hollow hole, flat shape
- Non-backlash
- High positioning and rotational accuracies
- Coaxial input and output
- Compact and simple design
- High torque capacity
- High stiffness

To minimize space for machines and systems and a total cost reduction, the SHF series has achieved a large bore with hollow hole and flat shape.

Life : 7,000h

•SHF Series Ratings

Item Model No.	Reduction Ratio	Rated Torque at 2000rpm		Permissible Peak Torque at Start and Stop		Permissible Maximum Momentary Torque	
		N-m	kgf-m	N-m	kgf-m	N-m	kgf-m
14	30	4.0	0.4	19.0	0.92	17	1.7
	50	5.4	0.55	18	1.8	35	3.6
	80	7.8	0.80	23	2.4	47	4.8
	100	7.8	0.80	28	2.9	54	5.5
17	30	8.8	0.90	6	1.6	30	3.1
	50	16	1.6	34	3.5	70	7.1
	80	22	2.2	43	4.4	87	8.9
	100	24	2.4	54	5.5	110	11
20	30	15	1.5	27	2.8	50	5.1
	50	25	2.5	56	5.7	98	10
	80	34	3.5	74	7.5	127	13
	100	40	4.1	82	8.4	147	15
25	30	27	2.8	50	5.1	95	9.7
	50	39	4.0	98	10	186	19
	80	63	6.4	137	14	255	26
	100	67	6.8	157	16	284	29
32	30	54	5.5	100	10	200	20
	50	76	7.8	216	22	382	39
	80	118	12	230	31	568	58
	100	137	14	333	34	647	66

Item Model No.	Reduction Ratio	Rated Torque at 2000rpm		Permissible Peak Torque at Start and Stop		Permissible Maximum Momentary Torque	
		N-m	kgf-m	N-m	kgf-m	N-m	kgf-m
40	50	137	14	402	41	686	70
	80	206	21	519	53	980	100
	100	265	27	568	58	1080	110
	120	294	30	617	63	1180	120
45	50	176	18	500	51	950	97
	80	313	32	706	72	1270	130
	100	353	36	755	77	1570	160
	120	402	41	823	84	1760	180
50	50	245	25	715	73	1430	146
	80	372	38	941	96	1860	190
	100	470	48	980	100	2060	210
	120	529	54	1080	110	2180	220
58	50	353	36	1020	104	1960	200
	80	549	56	1480	151	2450	250
	100	696	71	1590	162	3180	325
	120	745	76	1720	176	3330	340

•Cross Roller Bearing Specification

Item Model No.	Basic Rated Load				Permissible Moment Load Mc		Moment Stiffness Km	
	Basic Dynamic Rated Load C		Basic Static Rated Load Co		N-m	kgf-m	×10 ⁴ N-m/rad	kgf-m/arc-min
	×10 ² N	kgf	×10 ² N	kgf				
14	58	590	86	880	74	7.6	8.5	2.5
17	104	1060	163	1670	124	12.6	15.1	4.6
20	146	1490	220	2250	187	19.1	25.2	7.5
25	218	2230	358	3660	258	26.3	39.2	11.6
32	382	3900	654	6680	580	59.1	100	29.6
40	433	4410	816	8330	849	86.6	179	53.2
45	776	7920	1350	13800	1127	115	257	76.3
50	816	8330	1490	15300	1487	152	351	104
58	874	8920	1710	17500	2180	222	531	158
65	1300	13300	2230	22700	2740	280	741	220

- "Basic dynamic rated load" is a constant stationary radial load that achieves a basic dynamic rated life of the bearing of one million revolutions.
- "Basic static rated load" is a static load that achieves a contact stress of a constant level (408kN/mm²) at the center of a contact zone between the rolling element receiving a maximum load and track.

Main Application Target

- Robots
- Humanoid robots
- Metal machine tools
- Metal working machines
- Printing, bookbinding and paper processing machines
- Semiconductor manufacturing systems
- Measurement, analytical and test systems
- Medical equipment
- Optical machines
- Telescopes
- Wood, light metal and plastic machine tools
- Paper-making machines
- Crating and packaging machines
- Flat panel display manufacturing systems
- Printed circuit board manufacturing machines
- Space equipment
- Glass and ceramic manufacturing systems

**Please contact
Harmonic Drive LLC
for a detailed
catalog of this
product.**

Unit/Compact Double Shaft Type
Gear Head Type/Small Capacity Type

CSF mini Series

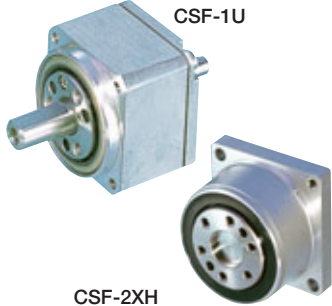

CSF-1U

CSF-2XH

- Non-backlash, high positioning and rotational accuracies
- Compact, lightweight, high torque capacity
- High load capacity
- Compact 4-point contact ball bearing mounted in main shaft
- Versatile reduction ratio range and shapes to meet with various applications

To realize a minimum space requirement, the axial length has been reduced to about one half. Four compact models are available in this mini series.

Life : 7,000h

•CSF mini Series Ratings

Model No.	Item	Reduction Ratio	Rated Torque at 2000rpm	Permissible Peak Torque at Start and Stop	Permissible Maximum Momentary Torque
			N·m	N·m	N·m
5		30	0.25	0.5	0.9
		50	0.4	0.9	1.8
		100	0.6	1.4	2.7
8		30	0.9	1.8	3.3
		50	1.8	3.3	6.6
		100	2.4	4.8	9
11		30	2.2	4.5	8.5
		50	3.5	8.3	17
		100	5	11	25
14		30	4	9	17
		50	5.4	18	35
		80	7.8	23	47
		100	7.8	28	54

•Cross Roller Bearing Specification

Model No.	Item	Basic Rated Load		Permissible Moment Load Mc	Moment Stiffness Km
		Basic Dynamic Rated Load C	Basic Static Rated Load Co		
		×10 ² N	×10 ² N	N·m	N·m / rad
5		9.14	7.63	0.89	7.41×10 ²
8		21.6	19.0	3.46	2.76×10 ³
11		38.9	35.4	6.6	7.41×10 ³
14		61.2	58.5	13.2	1.34×10 ⁴

Main Application Target

- Robots
- Humanoid robots
- Metal working machines
- Printing, bookbinding and paper processing machines
- Semiconductor manufacturing systems
- Measuring, analyzing and testing systems
- Medical equipment
- Optical machines
- Telescopes
- Wood, light metal and plastic working machines
- Paper-making machines
- Crating and packaging machines
- Flat panel display manufacturing systems
- Printed circuit board manufacturing machines
- Space equipment
- Aircraft
- Glass and ceramic manufacturing systems

**Please contact
Harmonic Drive LLC
for a detailed
catalog of this
product.**

Drawings (DXF) can be downloaded from our home page. URL: <http://www.HarmonicDrive.net>

Simple Unit/Super Flat, Hollow Type

SHD Series



- Super flat shape
- Hollow structure
- High positioning accuracy

A simple unit type comprised of a cross roller bearing of high moment stiffness on the output side. Six models are available in the series.

Life : 7,000h

•SHD Series Ratings

Model No.	Item	Reduction Ratio	Rated Torque at 2000rpm		Permissible Peak Torque at Start and Stop		Permissible Maximum Momentary Torque	
			N•m	kgf•m	N•m	kgf•m	N•m	kgf•m
14	50	50	3.7	0.38	12	1.2	23	23
		100	5.4	0.55	19	1.9	35	3.6
17	50	50	11	1.1	23	2.3	48	4.9
		100	16	1.6	37	3.8	71	7.2
20	50	50	17	1.7	39	4.0	69	7.0
		100	28	2.9	57	5.8	95	10
		160	28	2.9	64	6.5	95	10
25	50	50	27	2.8	69	7.0	127	13
		100	47	4.8	110	11	184	19
		160	47	4.8	123	13	204	21
32	50	50	53	5.4	151	15	268	27
		100	96	10	233	24	420	43
		160	96	10	261	27	445	45
40	50	50	96	10	281	29	480	49
		100	185	19	398	41	700	71
		160	206	21	453	46	765	78

•Cross Roller Bearing Specification

Model No.	Item	Basic Rated Load				Permissible Moment Load Mc		Moment Stiffness Km	
		Basic Dynamic Rated Load C		Basic Static Rated Load Co		N•m	kgf•m	×10 ⁴ N•m/rad	kgf•m /arc-min
		×10 ² N	kgf	×10 ² N	kgf				
14		29	296	43	438	37	3.8	7.08	2.1
17		52	530	81	826	62	6.3	12.7	3.8
20		73	744	110	1122	93	9.5	21	6.2
25		109	1111	179	1825	129	13.2	31	9.2
32		191	1948	327	3334	290	29.6	82.1	24.4
40		216	2203	408	4160	424	43.2	145	43.0

- “Basic dynamic rated load” is a constant stationary radial load that achieves a basic dynamic rated life of the bearing of one million revolutions.
- “Basic static rated load” is a static load that achieves a contact stress of a constant level (4kN/mm²) at the center of a contact zone between the rolling element receiving a maximum load and track.

Main Application Target

- Robots
- Humanoid robots
- Semiconductor manufacturing systems
- Flat panel display manufacturing systems
- Space equipment

**Please contact
Harmonic Drive LLC
for a detailed
catalog of this
product.**

HDUF and HDUR Series



HDUF

HDUR

The HDUF and HDUR series are designed flat and thin as a component to be installed in a customer-supplied assembly.

Life: 3,000h

•HUUF, HDUR Series Ratings

Item Model No.	Reduction Ratio	Output Torque kgf•m	
		HDUF Series at 1500rpm	HDUR Series at 1450rpm
14	88	0.8	1.0
	100	0.8	1.0
	110	0.8	1.0
17	50	1.1	2.2
	100	1.4	2.8
20	80	1.6	3.1
	100	2.0	3.7
	128	2.5	4.4
25	80	3.0	5.8
	100	3.5	6.8
	120	4.0	7.1
32	160	4.5	7.4
	200	-	7.5
	78	6.5	11
	100	9.0	15
	131	10	16
40	157	12	16
	200	-	16
	260	-	16
	80	12	20
	100	14	27
	128	16	32
50	160	16	32
	200	-	32
	258	-	32
	80	20	36
	100	26	57
65	120	30	60
	160	34	60
	200	-	60
	242	-	60
	78	-	78
80	104	-	112
	132	-	112
	158	-	112
	208	-	112
	260	-	112
	80	-	140
100	96	-	184
	128	-	222
	160	-	222
	194	-	222
	258	-	222
	320	-	222
	80	-	252
150	100	-	380
	120	-	406
	160	-	406
	200	-	406
	242	-	406
	320	-	460

Item Model No.	Reduction Ratio	Output Torque kgf•m	
		HDUF Series at 1500rpm	HDUR Series at 1450rpm
50	80	20	36
	100	26	57
	120	30	60
	160	34	60
	200	-	60
65	242	-	60
	78	-	78
	104	-	112
	132	-	112
	158	-	112
80	208	-	112
	260	-	112
	80	-	140
	96	-	184
	128	-	222
	160	-	222
100	194	-	222
	258	-	222
	320	-	222
	80	-	252
	100	-	380
	120	-	406
	160	-	406
150	200	-	406
	242	-	406
	320	-	460

Main Application Target

- Printing, bookbinding and paper processing machines
- Energy
- Crating and packaging machines

**Please contact
Harmonic Drive LLC
for a detailed
catalog of this
product.**

HDB Series

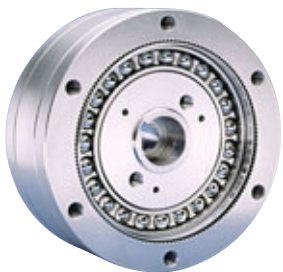

- The HDB series achieves a 1:1 gear ratio
- Precise phasing between input and output is achieved

• HDB Series Ratings

Size	Ratio	Maximum Input Rpm		Rated Torque @1750 RPM		Maximum Output Torque		Approximate Wave Generator Inertia		No Load Starting Torque	
		Oil	Grease	lb-in	Nm	lb-in	Nm	lb-in ²	Kg-cm ²	oz-in	N-cm
20	80	6000	3500	246	28	250	28	0.049	0.144	4.5	3.2
	100			246	28	300	34				
	120			246	28	350	40				
	160			246	28	390	44				
25	80	5000	3500	406	46	425	48	0.124	0.362	6	4.3
	100			406	46	600	68				
	120			406	46	700	79				
	160			406	46	780	88				
32	80	4500	3500	810	92	950	107	0.45	1.31	8	5.6
	100			810	92	1200	136				
	120			810	92	1400	158				
	160			810	92	1550	175				
40	80	400	3000	1705	193	1700	192	1.17	3.43	27	19
	100			1705	193	2400	271				
	120			1705	193	2700	305				
	160			1705	193	3100	350				
50	80	3500	2500	3180	359	3100	350	3.39	9.89	50	36
	100			3180	359	4200	475				
	120			3180	359	5200	588				
	160			3180	359	5800	655				

Main Application Target

- For dynamic registration of rotating elements
- A 1:1 differential with high-ratio trim adjustment
- Ideal differential for roll registration or angular shaft phasing
- Compact, low-backlash design for end-of-roll mounting

**Please contact
Harmonic Drive LLC
for a detailed
catalog of this
product.**

HDT Series



- Zero backlash
- Precise positional accuracy
- Large center through hole
- High ratio
- High torque
- ± 5 arc second repeatability

• HDT Series Ratings

Size	Standard Ratio*	RATED OUTPUT TORQUE						Maximum Repetitive Output Torque		Maximum Momentary Output Torque		Static Torque Limit		No-Load Starting Torque oz in. (Ncm)
		3500 RPM		1750 RPM		1000 RPM								
		lb in	Nm	lb in	Nm	lb in	Nm	lb in	Nm	lb in	Nm	lb in	Nm	
14	50	81	9.2	102	11.5	119	13.9	119	13.4	140	15.8	202	22.8	1 -0.7
	72	81	9.2	102	11.5	119	13.9	119	13.4	200	22.6	202	22.8	
	80	81	9.2	102	11.5	123	13.9	140	15.8	200	22.6	238	26.9	
	100	81	9.2	102	11.5	123	13.9	180	20.3	200	22.6	306	34.6	
20	50	278	31.4	350	40	422	47.7	470	53	1120	127	1280	145	2.5 -1.8
	60	281	31.8	355	40.1	428	48.4	470	53	1120	127	1280	145	
	80	281	31.8	355	40.1	428	48.4	470	53	1260	142	1240	140	
	100	297	33.6	375	42.4	452	51	690	78	1260	142	1620	183	
	160	297	33.6	375	42.4	452	51	1120	127	1120	127	2480	280	
25	50	476	54	600	68	723	82	830	94	1580	179	2570	290	5 -3.5
	60	492	56	620	70	747	84	830	94	1580	179	2570	290	
	80	492	56	620	70	747	84	830	94	2050	232	2310	261	
	100	492	56	620	70	747	84	1240	140	2050	232	3050	345	
	160	492	56	620	70	747	84	1700	192	1900	215	4650	525	
	200	492	56	620	70	747	84	1580	178	1580	178	5320	601	
32	50	952	108	1200	136	1446	164	1830	207	4000	452	4920	556	11 -7.8
	60	989	111	1245	140	1500	169	1830	207	4000	452	4920	556	
	80	989	111	1245	140	1500	169	1830	207	5000	565	4520	556	
	100	989	111	1245	140	1500	169	2640	298	5000	565	5800	655	
	160	989	111	1245	140	1500	169	4700	531	4700	531	9190	1038	
	200	989	111	1245	140	1500	169	4000	452	4000	452	10610	1199	
40	50	1587	179	2000	226	2410	272	2760	312	6600	746	7330	828	20 -14.1
	60	1646	186	2075	234	2500	282	2760	312	6600	746	7330	828	
	80	1646	186	2075	234	2500	282	2760	312	9000	1017	6980	789	
	100	2071	234	2610	295	3145	355	4070	460	9000	1017	9450	1068	
	160	2071	234	2610	295	3145	355	7200	813	7200	813	14640	1654	
	200	2071	234	2610	295	3145	355	6600	746	6600	746	17010	1922	
50	50	3016	341	3800	430	4579	577	5110	577	15500	1751	13910	1571	40 -28.3
	60	3087	349	3890	440	4687	529	5110	577	15500	1751	13910	1571	
	80	3087	349	3890	440	4687	529	5110	577	19000	2147	13060	1475	
	100	3857	436	4860	549	5857	661	6500	734	19000	2147	16860	1904	
	160	3857	436	4860	549	5857	661	13100	1480	17000	1921	26830	3031	
	200	3857	436	4860	549	5857	661	15500	1751	15500	1751	31190	3524	

High-performance Gear Head/Small- and Medium-capacity Motor Type for Servomotors

CSF-GH Series

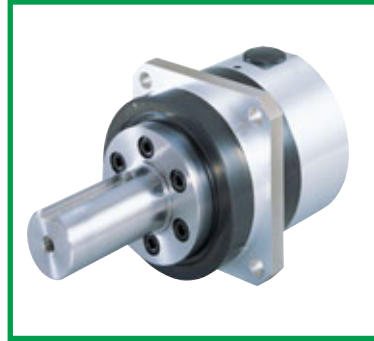

- Easy mounting with servomotors manufactured by various manufacturers
- Versatile variation
- Excellent sealed structure
- Non-backlash
- High moment capacity

This quick connect design allows easy installation and mounting of a wide variety of servo motors.

Life : 7,000h

•CSF-GH Series Ratings

Item Model No.	Reduction Ratio	Output Torque at 2000rpm		Peak Torque at Start and Stop		Maximum Momentary Torque	
		N·m	kgf·m	N·m	kgf·m	N·m	kgf·m
14	50	5.4	0.55	18	1.8	35	3.6
	80	7.8	0.80	23	2.4	47	4.8
	100	7.8	0.80	28	2.9	54	5.5
20	50	25	2.5	56	5.7	98	10
	80	34	3.5	74	7.5	127	13
	100	40	4.1	82	8.4	147	15
	120	40	4.1	87	8.9	147	15
	160	40	4.1	92	9.4	147	15
32	50	76	7.8	216	22	382	39
	80	118	12	304	31	568	58
	100	137	14	333	34	647	66
	120	137	14	353	36	686	70
	160	137	14	372	38	686	70
45	50	176	18	500	51	950	97
	80	313	32	706	72	1270	130
	100	353	36	755	77	1570	160
	120	402	41	823	84	1760	180
	160	402	41	882	90	1910	195
65	80	745	76	2110	215	3720	380
	100	951	97	2300	235	4750	485
	120	951	97	2510	256	4750	485
	160	951	97	2630	268	4750	485

•Cross Roller Bearing Specification

Item Model No.	Basic Rated Load				Permissible Moment Load Mc		Moment Stiffness Km	
	Basic Dynamic Rated Load C		Basic Static Rated Load Co		N·m	kgf·m	×10 ⁴ N·m/rad	kgf·m/ arc-min
	N	kgf	N	kgf				
14	5110	521	7060	720	27	2.76	3.0	0.89
20	10600	1082	17300	1765	145	14.8	17	5.0
32	20500	2092	32800	3347	258	26.3	42	12
45	41600	4245	76000	7755	797	81.3	100	30
65	81600	8327	149000	15204	2156	220	323	96

• “Basic dynamic rated load” is a constant stationary radial load that achieves a basic dynamic rated life of the bearing of one million revolutions.
 “Basic static rated load” is a static load that achieves a contact stress of a constant level (4kN/mm²) at the center of a contact zone between the rolling element receiving a maximum load and track.

•Corresponding servomotor capacity

The CSF-GH series is designed to mount to a range of servo motors with output power ranging from 30W to 5000W.

Main Application Target

- Robots
- Humanoid robots
- Metal machine tools
- Printing, bookbinding and paper processing machines
- Semiconductor manufacturing systems
- Measurement, analytical and test systems
- Medical equipment
- Optical machines
- Telescopes
- Wood, light metal and plastic machine tools
- Paper-making machines
- Crating and packaging machines
- Flat panel display manufacturing systems
- Printed circuit board manufacturing machines
- Space equipment
- Aircraft
- Glass and ceramic manufacturing systems

**Please contact
Harmonic Drive LLC
for a detailed
catalog of this
product.**

HPG Series

- Highly accurate Planetary gearhead
- Short delivery (Some models can be delivered in one week)
- High torque capacity
- High moment capacity
- Easy mounting with servomotors manufactured by various manufacturers
- Low backlash: Less than 3 arc min (less than 1 minute option)
- High efficiency, 90% or higher. (85% only for Model 14)
- Excellent sealed structure
- Double shaft type as new model

Life : 20,000h

•HPG Series Ratings

Model No.	Item	Reduction Ratio	Output Torque at 3000rpm		Peak Torque at Start and Stop		Maximum Momentary Torque	
			N·m	kgf·m	N·m	kgf·m	N·m	kgf·m
14		5	6	0.6	23	2.3	56	5.7
		11	8	0.8				
		15	9	0.9				
		21	9	0.9				
		33	10	1.0				
20		45	10	1.0	100	10.2	217	22.1
		5	16	1.6				
		11	20	2.0				
		15	24	2.4				
		21	25	2.5				
32		33	29	3.0	300	30.6	650	66.3
		45	29	3.0				
		5	66	6.7				
		11	88	9.0				
		15	92	9.4				
50		21	98	10.0	850	86.7	1850	189
		33	108	11.0				
		45	108	11.0				
		5	150	15.3				
		11	176	18.0				

•Cross Roller Bearing Specification

Model No.	Item	Basic Rated Load				Permissible Moment Load Mc		Moment Stiffness Km	
		Basic Dynamic Rated Load C		Basic Static Rated Load Co		N·m	kgf·m	×10 ⁴ N·m/rad	kgf·m/ arc-min
		N	kgf	N	kgf				
14		5110	521	7600	720	32.3	3.29	3.0	0.89
20		10600	1082	17300	1765	183	18.7	17	5.0
32		20500	2092	32800	3347	452	46.1	42	12
50		41600	4245	76000	7755	1076	110	100	30

* "Basic dynamic rated load" is a constant stationary radial load that achieves a basic dynamic rated life of the bearing of one million revolutions.
 "Basic static rated load" is a static load that achieves a contact stress of a constant level (4kN/mm²) at the center of a contact zone between the rolling element receiving a maximum load and track.

•Corresponding servomotor capacity

The HPG series is designed to mount to a range of servo motors with output power ranging from 30W to 5000W.

Main Application Target

- Robots
- Humanoid robots
- Metal machine tools
- Metal working machines
- Printing, bookbinding and paper processing machines
- Semiconductor manufacturing systems
- Telescopes
- Wood, light metal and plastic machine tools
- Paper-making machines
- Crating and packaging machines
- Flat panel display manufacturing systems
- Printed circuit board manufacturing machines
- Aircraft
- Glass and ceramic manufacturing systems

**Please contact
Harmonic Drive LLC
for a detailed
catalog of this
product.**

Infinet-Indexer® Phase Adjuster



- Fine tune rotational position of shafts and machine parts
- Phase cams
- Adjust roll registration
- Take up backlash in spur and worm gears
- Synchronize indexing devices

Infinet-Indexers® are available from immediately from stock in the standard bore sizes shown, with keyways and set screws, and tapped holes for face mounting of either hub. It is possible for the user to modify these configurations by disassembling the unit. The hub material is low carbon mild steel suitable for each size are shown in notes to the dimensional drawings. Additional sizes and configurations are available by special order.

•3 Models, 6 Bore Sizes Available From Stock

HDI Size	Bore Size	O.D.	Length	Torque Capacity
-10	1/2"	2 3/8" (60.33mm)	1 11/16" (42.9mm)	1000 lb-in (113 Nm)
	5/8"			
	3/4"			
-25	3/4"	3" (76.2mm)	2 3/16" (76.2mm)	2500 lb-in (283 Nm)
	1"			
-50	1 1/4"	3 3/4" (95.3mm)	2 3/8" (95.3mm)	5000 lb-in (565 Nm)

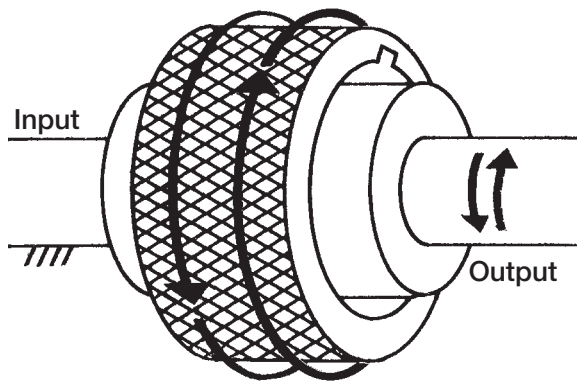

To operate, hand rotate the adjusting ring in either direction to produce a 100:1 reduction between the ring and the output. Adjust the friction adjustment/locking screw to desired resistance. For some applications, one adjustment will be sufficient for both shaft turning and phase adjusting modes. For more severe loading, such as hard stopping or higher torques, the friction adjustment/locking screw may be used to lock the adjusting ring in place to maintain phase.

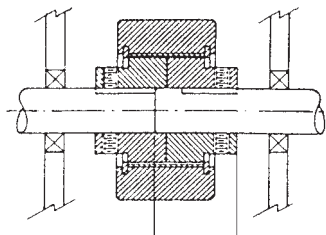

IN-LINE SHAFT

HDI Size	L DIM
-10	1.09
-25	1.34
-50	1.43

Flexible Couplings

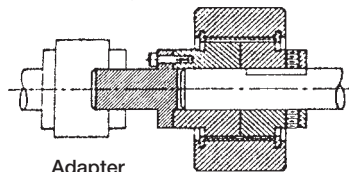

Adapter

IN-LINE SHAFT

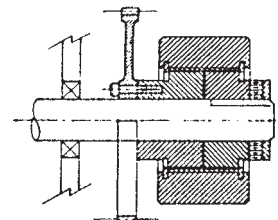

CONCENTRIC SHAFT

Main Application Target

- Phasing gears
- Adjusting printing rolls
- Adjusting backlash on ball nuts
- Aligning machine tools

**Please contact
Harmonic Drive LLC
for a detailed
catalog of this
product.**

FHA-C mini Series



This series servo actuators are comprised of harmonic drive components for precise motion control and super-flat AC servo motors. The body width is less than half of old models and has a large through hole in the center of the shaft through which electric cables, air pipe, and even laser beam can be passed through this through hole to simplify the entire structure of the machine and system.

The FHA-mini series is designed to operate with a wide range of third-party drivers, as well as Harmonic Drive LLC's HA655 and HA675 drivers.

•FHA-C mini Series Ratings

Item	Model	FHA-8C			FHA-11C			FHA-14C		
		30	50	100	30	50	100	30	50	100
Maximum Torque ^{※2}	N•m	1.8	3.3	4.8	4.5	8.3	11	9.0	18	28
	kgf•m	0.18	0.34	0.49	0.46	0.85	1.1	0.92	1.8	2.9
Maximum Positioning Speed	r/min	200	120	60	200	120	60	200	120	60
Torque Constant	N•m/A	3.9	6.7	13.6	3.8	6.6	13.3	4.2	7.2	14.7
	kgf•m/A	0.40	0.68	1.4	0.39	0.67	1.4	0.43	0.73	1.5
Maximum Current ^{※2}	A	0.61	0.64	0.48	1.5	1.6	1.1	2.9	3.2	2.4
Moment of Inertia	(GD ² /4) kg•m ²	0.0026	0.0074	0.029	0.0060	0.017	0.067	0.018	0.050	0.20
	(J) kgfcm ² •s ²	0.027	0.075	0.30	0.061	0.17	0.68	0.18	0.51	2.0
Reduction Ratio		30	50	100	30	50	100	30	50	100
Permissible Moment Load	N•m	15			40			75		
	kgf•m	1.5			4.1			7.7		
Moment Stiffness	N•m/rad	2x10 ⁴			4x10 ⁴			8x10 ⁴		
	kgf•m/rad	0.2x10 ⁴			0.4x10 ⁴			0.8x10 ⁴		
Detector Resolution (At x4) ^{※4}	Pulses/Revolution	240,000	400,000	800,000	240,000	400,000	800,000	240,000	400,000	800,000
Power Supply	v	AC 24, AC 100, AC 200								
Weight	kg	0.40			0.62			1.2		
Protection		Totally closed, self-cooling type (Equivalent to IP44)								
Environmental Conditions		Operating temperature: 0 to 40°C • Storage temperature: -20 to +60°C. Operating and storage humidity: 20 to 80% RH (No condensation permitted). Vibration resistance : 25m/s ² (frequency: 10 to 400Hz) • Shock resistance: 300m/s ² . Indoor installation: No dust, no metal powder, no corrosive gas, no inflammable gas, no oil mist, no other foreign matter and no direct sunshine. Altitude 1000m or less. Insulation resistance: 100MΩ or higher (DC 500V). Dielectric strength: AC 1500V/1min. Insulation class: Class B								
Mounting Direction		All directions								
Safety Standard		CE Marking								
Driver in Combination		HA-655-1/HA-675-1								

- 1 The figures in the table are those at the output shaft.
- 2 The figures are measured when combined with an HA-655 servo driver.
- 3 The figures are typical values.
- 4 The quad encoder resolution is obtained by the formula (motor encoder resolution) x4 x (reduction ratio)

Main Application Target

- Semiconductor manufacturing systems
- Measurement, analytical and test systems
- Medical equipment
- Optical machines
- Telescopes
- Wood, light metal and plastic machine tools
- Flat panel display manufacturing systems
- Communication equipment
- Printed circuit board manufacturing machines
- Aircraft
- Glass and ceramic manufacturing systems

**Please contact
Harmonic Drive LLC
for a detailed
catalog of this
product.**

FHA-C Series



This series servo actuators are comprised of Harmonic drive components for precise motion control and super-flat AC servo motors. The body width is less than half of old models and has a large through hole in the center of the shaft through which electric cables, air pipes, and even laser beam can be passed through this through hole to simplify the entire structure of the machine and system.

The FHA-C series is designed to operate with a wide range of third party drivers as well as Harmonic Drive LLC's HA655 and HA675 drivers.

•FHA-C Series Ratings

Item	Model	FHA-17C			FHA-25C			FHA-32C			FHA-40C		
		50	100	160	50	100	160	50	100	160	50	100	160
Maximum Torque ^{※2}	N•m	39	57	64	150	230	260	281	398	453	500	690	820
	kgf•m	4.0	5.8	6.5	15.3	23.5	26.5	28.7	40.6	46.2	51.0	70.4	83.7
Maximum Rotational Speed	r/min	96	48	27	90	45	28	80	40	25	70	35	22
Torque Constant	N•m/A	21	42	67	22	45	72	27	54	86	31	64	102
	kgf•m/A	2.1	4.3	6.8	2.3	4.6	7.3	2.8	5.5	8.8	3.2	6.5	10.4
Maximum Current ^{※2}	A	2.1	1.6	1.1	7.3	5.6	4.0	11.4	8.0	5.9	17.3	11.8	9.0
Moment of Inertia (GD ² /4) (J)	kg•m ²	0.17	0.67	1.7	0.81	3.2	8.3	1.8	7.1	18.1	4.9	19.5	50
	kgf•cm•s ²	1.7	6.9	17	8.3	33	85	18	72	185	50	200	510
Reduction Ratio		50	100	160	50	100	160	50	100	160	50	100	160
Permissible Moment Load	N•m	188			370			530			690		
	kgf•m	19			38			54			70		
Moment Stiffness	N•m/rad	220x10 ³			490x10 ³			790x10 ³			1400x10 ³		
	kgf•m/rad	22x10 ³			50x10 ³			80x10 ³			140x10 ³		
Detector Resolution (At x4) ^{※4}	Pulses/Revolution	500,000	1,000,000	1,600,000	500,000	1,000,000	1,600,000	500,000	1,000,000	1,600,000	500,000	1,000,000	1,600,000
Power Supply	V	AC 24, AC 100, AC 200			AC 100, AC 200			AC 100, AC 200			AC 100, AC 200		
Weight	kg	2.5			4.0			6.5			12		
Protection		Totally closed, self-cooling (Equivalent to IP44)											
Environmental Conditions		Operating temperature: 0 to 40°C/Storage temperature: -20 to 60°C • Operating and storage humidity: 20 to 80% RH (no condensation permitted). Insulation resistance: 100MΩ (DC 500V) • Dielectric strength: AC 1500V/1min. Vibration resistance: 24.5m/s ² (frequency: 10 to 400Hz) • Shock resistance: 294m/s ² . Indoor installation: No dust, no metal powder, no corrosive gas, no oil mist, no other foreign matter and no direct sunshine • Altitude 1000m or less.											
Mounting Direction		All directions											
Safety Standard		CE Marking											
Driver in Combination		HA-655-2-200/HA-675-2-200						HA-655-4-200/HA-675-4-200					

- 1 The figures in the table are those at the output shaft.
- 2 The figures are measured when combined with an HA-655 servo driver.
- 3 The figures are typical values.
- 4 The quad encoder resolution is obtained by the formula (motor encoder resolution) x4 x (reduction ratio)

Main Application Target

- Robots
- Metal machine tools
- Metal working machines
- Printing, bookbinding and paper processing machines
- Semiconductor manufacturing systems
- Wood, light metal and plastic machine tools
- Crating and packaging machines
- Flat panel display manufacturing systems
- Communication equipment
- Printed circuit board manufacturing machines

**Please contact
Harmonic Drive LLC
for a detailed
catalog of this
product.**

PowerHub™



Benefits of the PowerHub include:

- High torque
- Positional accuracy
- Fast response
- Smooth, repeatable performance
- More compact than competitive products
- Handles large thrust and moment loads

• Specifications

	Units	HKM-20-60	HKM-20-30	HKM-25-60	HKM-25-30
Rated Power	Watts	100		200	
Rated Torque	in-lb	115	233	233	440
	N-m	13	26	26	50
Maximum Torque	in-lb	345	700	830	1330
	N-m	39	79	94	150
Rated Speed	r/min	60	30	60	30
Maximum Speed	r/min	80	40	80	40
Current, rated	A	1.8	1.4	4.8	3
Current, max.	A	5	4	14	9
Thermal Time Constant	min.	~25		~30	
Gear Reduction Ratio	R:1	50	100	50	100
Output Resolution	P/rev.	50,000	100,000	75,000	150,000
	arc sec	26	13	17	9
Absolute accuracy	± arc sec	75	40	60	40
Motor Type: 3 Phase Brushless					
Number of poles		8			
Torque Constant	in-lb/A	2.8		1.7	
Back EMF	V/kRPM	33.3		20.2	
Motor Resistance	Ohms	15.7		1.5	
Motor Inductance	mH	10.3		1.8	
Inertia	kg-cm ²	0.35		1.91	
Encoder Type: Optical Incremental					
Output Circuit	Type: Line Driver				
Resolution (Encoder Only)	P/rev.	1000		1500	
Output Signal	3 Channels	A -A B -B I -I			
Power		+5VDC ±10% & 250 mA Max.			
Drive Consult factory for options					

Main Application Target

- Robots
- Metal machine tools
- Metal working machines
- Printing, bookbinding and paper processing machines
- Semiconductor manufacturing systems
- Wood, light metal and plastic machine tools
- Crating and packaging machines
- Flat panel display manufacturing systems
- Communication equipment
- Printed circuit board manufacturing machines

**Please contact
Harmonic Drive LLC
for a detailed
catalog of this
product.**

AC Servo Actuators RSF Series



The AC servo actuators in the RSF series are comprised of Harmonic drive component for precise motion control and an AC servomotor, featuring a high torque, high rotational accuracy in compact design. The RSF series AC servo actuators are best suited as positioning drive for machines and systems that require downsizing.

•RSF Series Ratings

Item	Model	RSF-5A			
		30	50	100	
Power supply voltage	V	DC24			
Allowable continuous current	A	1.11	0.92	0.76	
Allowable continuous torque (during operation at allowable continuous rotation speed)	N•m	0.18	0.29	0.44	
	kgf•cm	1.83	2.95	4.48	
Allowable continuous rotation speed (output shaft)	r/min	150	90	45	
Allowable continuous stall torque	N•m	0.28	0.44	0.65	
	kgf•cm	2.85	4.48	6.62	
Instantaneous maximum current	A	2.3	2.2	1.7	
Max. torque	N•m	0.5	0.9	1.4	
	kgf•cm	5.1	9.17	14.3	
Max. speed	r/min	333	200	100	
Torque constant	N•m/A	0.3	0.54	1.1	
	kgf•cm/A	3.06	5.51	11.22	
MEF constant	V/(r/min)	0.04	0.07	0.13	
Phase resistance (at 20°C)	Ω	0.82			
Phase inductance	mH	0.27			
Moment of inertia Note 4	GD ² /4	kg•m ²	0.66x10 ⁻⁴ (0.11x10 ⁻³)	1.83x10 ⁻⁴ (0.31x10 ⁻³)	7.31x10 ⁻⁴ (1.23x10 ⁻³)
	J	kgf•cm•s ²	0.67x10 ⁻³ (1.13x10 ⁻³)	1.87x10 ⁻³ (3.15x10 ⁻³)	7.45x10 ⁻³ (12.6x10 ⁻³)
Gear ratio			1:30	1:50	0.111
Allowable radial load (output shaft central value)	N	90			
	kgf	9.1			
Allowable thrust load	N	270			
	kgf	27.5			
Encoder pulses (motor shaft)	Pulse	500			
Encoder resolution (Output shaft: when multiplied by 4)	Note 5	Pulse/Rotation	60,000	100,000	200,000
Motor shaft brake	Input power supply voltage	V	DC24		
	Retention torque	N•M	0.18	0.29	0.44
kgf•cm		1.83	2.95	4.48	
Mass	Without brake	g	66.0 (except clamp filter)		
	With brake	g	86 (except clamp filter)		
Combined driver			HA-680-4B-24		

Note 1: The table shows typical output values of actuators.

Note 2: the values in the table above are obtained when it is combined with the combined driver (HA-680-4B-24).

Note 3: All values are typical.

Note 4: The moment of inertia is the total value of the motor shaft and Harmonic Drive moment of inertia values converted to the output side.
The values in parentheses are for equipment with a brake.

Note 5: The encoder resolution is (motor shaft encoder resolution when multiplied by 4) x (gear ratio).

RH Series



The DC servo actuator RH series are comprised of Harmonic drive component for precision motion control and a DC servomotor, featuring a high torque, high rotational accuracy in compact design compactness. The RH series DC servo actuators are best suited as positioning drive sources for machines and systems that require downsizing.

•RH Series Ratings

Item		Model	RH-5A			RH-8D		RH-11D		RH-14D	
			8802	5502	4402	6006	3006	6001	3001	6002	3002
Rated Output	W		1.5	1.7	1.4	8.6	6.2	13.6	12.3	20.3	18.5
Rated Voltage	V		12	12	12	24	24	24	24	24	24
Maximum Momentary Torque	N•m		0.39	0.59	0.69	2.7	3.5	4.9	7.8	14	20
	kgf•cm		4.0	6.0	7.0	27	36	50	80	140	200
Maximum Continuous Stall Torque	N•m		0.24	0.39	0.43	1.5	2.3	2.5	4.4	5.4	7.8
	kgf•cm		2.4	4.0	4.4	15	23	25	45	55	80
Rated Torque	N•m		0.16	0.29	0.29	1.4	2.0	2.2	3.9	3.2	5.9
	kgf•cm		1.6	3.0	3.0	14	20	22	40	33	60
Maximum Positioning Speed	r/min		180	110	90	100	50	100	50	100	50
Rated Positioning Speed	r/min		88	55	44	60	30	60	30	60	30
Maximum Momentary Current	A		0.83	0.78	0.77	1.6	1.1	2.4	2.1	5.4	4.1
Rated Current	A		0.5	0.5	0.5	1.0	0.8	1.3	1.3	1.8	1.8
Torque Constant	N•m/A		0.69	1.11	1.38	2.1	4.2	2.46	4.91	2.92	5.76
	kgf•cm/A		7.06	11.3	14.1	21.4	42.9	25.1	50.1	29.8	58.8
Moment of Inertia	kg•m ²		6.3×10 ⁻⁴	16×10 ⁻⁴	25×10 ⁻⁴	37×10 ⁻⁴	150×10 ⁻⁴	110×10 ⁻⁴	430×10 ⁻⁴	210×10 ⁻⁴	810×10 ⁻⁴
	kgf•cm•s ²		0.007	0.016	0.026	0.04	0.15	0.11	0.44	0.21	0.83
Permissible Thrust Load	N		29	29	29	98	98	196	196	392	392
	kgf		3.0	3.0	3.0	10	10	20	20	40	40
Reduction Ratio			50	80	100	50	100	50	100	50	100
Weight	kg		0.09	0.09	0.09	0.3	0.3	0.5	0.5	0.77	0.77
Environmental conditions	Time constant : Continuous • Protection : Totally closed, self-cooling • Ambient temperature : 0 to 40°C Ambient humidity: 35 to 80% RH (no condensation permitted)										
Driver in Combination			HA-360-1A			HS-360-1B		HS-360-1C		HS-360-1D	

Main Application Target

- Semiconductor manufacturing systems
- Measurement, analytical and test systems
- Medical equipment
- Optical machines
- Paper-making machines
- Crating and packaging machines
- Flat panel display manufacturing systems
- Aircraft

**Please contact
Harmonic Drive LLC
for a detailed
catalog of this
product.**

RHS/RFS Series



RHS-25

RFS-25

- Small, lightweight, and high-torque
- Standard lineup of actuators with a brake
- Superior positioning precision
- Stable controllability

•RHS/RFS Series DC Servo Actuators

Item	Model	Actuator	RHS-20, RFS-20				RHS-25, RFS-25				RHS-32, RFS-32			
			6007	3007	6012	3012	6012	3012	6018	3018	6018	3018	6030	3030
Maximum Output Torque 1) 2) T_m		in-lb	495	729	495	729	868	1390	868	1390	1910	2950	1910	2950
		Nm	57	84	57	84	100	160	100	160	220	340	220	340
Maximum Output Speed 1)		rpm	80	40	80	40	100	160	100	160	220	340	220	340
Torque Constant		in-lb/A	91	182	91	182	91	182	91	199	100	189	115	231
		Nm/A	10.5	21.0	10.5	21.0	10.5	21.0	11.5	22.9	11.5	22.9	13.3	26.6
Peak Current 1) 2)		A	6.2	4.8	6.4	5.0	10.7	8.8	10.0	8.3	20.6	16.3	18.2	14.4
Inertia at Output Shaft 3)		in-lb-sec ²	2.5	10.4	4.1	16.5	4.6	18.2	9.5	39	12.2	50	27	104
		kgm ²	0.29	1.2	0.47	1.9	0.53	2.1	1.1	4.5	1.4	5.8	3.1	12.0
Gear Ratio		1:R	50	100	50	100	50	100	50	100	50	100	50	100
Maximum Radial Load 3)		lb	309		441		661		551		992		882	
		N	RHS:1400		RFS:2000		RHS:3000		RFS:2500		RHS:4500		RFS:4000	
Maximum Axial Load		lb	309		198		661		243		992		353	
		N	RHS:1400		RFS:900		RHS:3000		RFS:1100		RHS:4500		RFS:1600	
Actuator Accuracy		arc-min	1.0				1.0				1.0			
Actuator Repeatability		arc-sec	±5				±5				±5			
Rated Voltage 1)		V	75	75	75	75	75	75	75	75	75	75	85	85
	Control Units		HS-250-3				HS-250-6				HS-250-9			
			HS-350-3				HS-350-6				HS-350-9			
			HS-450 R-3				HS-450 R-6				HS-450 R-9			

Please Note:

- 1) The values are for saturated actuator temperature. Other values are for actuator temperature of 20°C.
- 2) Maximum allowable values. Under no circumstances may these limits be exceeded.
- 3) Cantilevered load applied at the midpoint of the shaft extension.

Main Application Target

- Semiconductor manufacturing systems
- Measurement, analytical and test systems
- Medical equipment
- Optical machines
- Paper-making machines
- Flat panel display manufacturing systems
- Communication equipment

**Please contact
Harmonic Drive LLC
for a detailed
catalog of this
product.**

HHA Chamberlink®



- Precise positional accuracy
- No rotary seals required
- Motor removable allowing bake out
- Integral feedthrough to vacuum

• Specifications

	UNIT	HHA-10-080	HHA-14-080
Rated Voltage	Volts	12	48
Rated Current	Amps	2	0.94
Rated Torque	in-lb/Nm	10/1.1	30/3.3
Rated Speed	RPM	22	22
Max Continuous Stall Torque	in-lb/Nm	15/1.7	50/5.6
Max Output Torque	in-lb/Nm	25/2.8	75/8.4
Max Current	Amps	4	4
Max Output Speed	RPM	60	60
Torsional Stiffness	in-lb/rad	4,500	13,500
Positional Accuracy	± arc min	4	2.8
Temp Range	Degrees F	-20 to 200	-20 to 200
Vacuum Pressure	torr	7-Oct	7-Oct
Leakage Rate [He]	scc/sec	11-Oct	11-Oct
Reduction Ratio	R:1	81:01:00	81:01:00
Inertia Input Shaft	lb-in ²	0.005	0.028
Max Overhung Load	lbs @ in	10 @ 3	24 @ 3
Max Axial Load	lbs	20	42

ENCODER	
Output Signal (Type)	TTL Compatible
Resolution (Encoder only) (CPR)	500
Output Signal (# Channels)	2 + 1 Index channel
Supply Voltage (Volts)	5 V ± 10%
Operating Temperature	30 to 160 (Degrees F)
Line Driver Components	26LS31 Line Driver
Termination	10 conductor ribbon cable
Vibration, Shock(G)	20g, 5 to 100hz
Lead Wire(mm)	500

Main Application Target

- Semiconductor manufacturing
- Flat panel display manufacturing
- Caustic environments

**Please contact
Harmonic Drive LLC
for a detailed
catalog of this
product.**

LPA



- Less than 1 arc minute positional accuracy
- Compact design
- Axial length of less than 2.6 inches
- Integral high performance brushless servo motor
- Double row angular contact output bearings
- High axial and moment loads
- Superior torque to weight ratio
- Adaptable to most controllers
- Low vibration
- High overhung load

•LPA

Ratio	xx:1	100	50
Max Continuous Output Speed	rpm	30	60
Max Momentary Output Speed	rpm	50	100
Rated Torque	(30/60 RPM)	250	200
Torque Constant (Input)	oz lb/amp	10.8	10.8
Speed Constant (Input)	peak volt/krpm	8	8
# Poles	pole	16	16
Terminal Resistance	Ohm	0.7	0.7
Terminal Inductance	mH	0.14	0.14
Max Accel/decl Torque	lb in	350	350
Weight	lbs	4.3	4.3
Thermal Resistance	deg c/watt	3.4	3.4
Allowable Moment	lb in	807	807

*Specifications configured on teknics amplifier. Other amplifiers are available.
Please contact factory with more information.

Frequency Response	100 KHz
Voltage	5 V
Current Draw	85ma Max
Lines	1000
Quad Counts	4000
Index	One Index

Main Application Target

- Robots
- Metal machine tools
- Metal working machines
- Printing, bookbinding and paper processing machines
- Semiconductor manufacturing systems
- Wood, light metal and plastic machine tools
- Crating and packaging machines
- Flat panel display manufacturing systems
- Communication equipment
- Printed circuit board manufacturing machines

**Please contact
Harmonic Drive LLC
for a detailed
catalog of this
product.**

Head

Precision Linear Actuators

LBC, LA•LAH and LNP Series

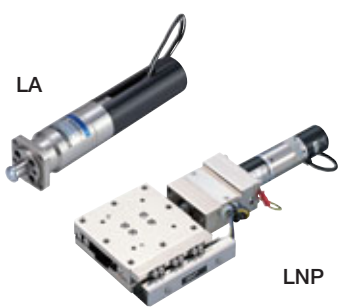

LA

LNP

The adopting high precision screw have realized high positioning accuracy to the micron and sub-micron order required in measuring instruments, test and inspection systems, optical equipment, semiconductor and liquid crystal manufacturing equipment.

•LBC Series Ratings

Model	Item	Drive	Stroke(mm)	Maximum Driving Force(N)	Resolution(μm)	Maximum Speed (mm/s)	Repeatability	Outside Dimensions (mm)	Total Length (mm)
LBC-25A-5D6K		AC motor	50	6000	0.32	20	±5μm or less/50mm stroke	φ136	353
LBC-25A-5D12K		AC motor	50	12000	0.16	10			

•LA Series Ratings

Model	Item	Drive	Stroke(mm)	Maximum Driving Force(N)	Resolution(μm)	Maximum Speed (mm/s)	Uni-directional Positioning Accuracy	Repeatability	Outside Dimensions (mm)	Total Length (mm)
LA-30B-10-F		DC motor	10	49	0.0174	0.9	2μm or less/40μm stroke	±0.1 μm or less/1mm stroke	□ 28	143
LA-32-30-F		DC motor	30	49	0.0174	0.9			□ 36	164

•LAH Series Ratings

Model	Item	Drive	Stroke(mm)	Maximum Driving Force(N)	Resolution(μm)	Maximum Speed (mm/s)	Uni-directional Positioning Accuracy	Repeatability	Outside Dimensions (mm)	Total Length (mm)
LAH-46-1002-F		DC motor	10	392	0.069	3.7	4μm or less/0.2mm stroke	±0.5μm or less/1mm stroke	□ 47	185
LAH-46-3002-F		DC motor	30	392	0.069	3.7			□ 47	204
LAH-80-5020-F-PA		Stepping motor	50	3000	2	10	4μm or less/2mm stroke	±1μm or less/1mm stroke	□ 85	320

•LNP Series Ratings

Model	Item	Drive	Stroke(mm)	Table Size (mm)	Load (kg)	Resolution(μm)	Maximum Speed (mm/s)	Uni-directional Positioning Accuracy	Repeatability	Total Length (mm)
LNP-4040-13	Stepping motor		13	40x40	10	0.04 0.02	1.8 1.5	6.0μm or less	±0.5μm or less	143.3
	DC servomotor	0.056 0.028				172.5				
LNP-5050-13	Stepping motor		13	50x50	10	0.04 0.02	1.8 1.5	6.0μm or less	±0.5μm or less	153.3
	DC servomotor	0.056 0.028				182.5				
LNP-6060-15	Stepping motor		15	60x60	10	0.04 0.02	1.8 1.5	6.0μm or less	±0.5μm or less	163.3
	DC servomotor	0.056 0.028				192.5				
LNP-7070-15	Stepping motor		15	70x70	10	0.04 0.02	1.8 1.5	6.0μm or less	±0.5μm or less	173.3
	DC servomotor	0.056 0.028				202.5				

• 1 Varies with the reduction ratio of the Harmonic Drive incorporated in the actuator.
 • Use the Suruga Seiki Co.,LTD. Micro Module PG Series product for the table.

Main Application Target

- Metal machine tools
- Flat panel display manufacturing systems
- Semiconductor manufacturing systems
- Communication equipment
- Telescopes
- Printed circuit board manufacturing machines
- Wood, light metal and plastic machine tools
- Glass and ceramic manufacturing equipment

**Please contact
 Harmonic Drive LLC
 for a detailed
 catalog of this
 product.**



The Galvano optical scanner LSA series for high-response and high-accuracy optical scanning are comprised of a unique compact motor and optical sensor. The combination with a dedicated driver allows continuous scanning, random access and other optical scanning in accordance with command signals.

• **LSA Series Ratings**

Model		Item	LSA-10A-30	LSA-50A-30
Maximum Angular Runout		Degrees	±15	±15
Rotor Moment of Inertia		g•cm ²	1.9	8.5
Torque Constant		N•m/A	0.008	0.05
Coil Resistance		W	0.28	1.5
Coil Inductance		mH	0.098	5.1
Sensor Linearity (At full scale)		%	±0.06	±0.06
Sensor Angle Sensitivity		V/r	0.275	0.32
Offset Drift		μrad/C	25	25
Scale Drift		%/C	0.005	0.015
Repeatability (Excluding offset/scale drift)* 1		mrad	±5	±5
1°step Response Load Condition: (2g•cm ²)* 2		ms	0.5	—
Sensor Power Supply		V	5±5%-15±5%	5±5%-15±5%
Sensor Power Consumption	5V±5%	mA	90(Max)	70(Max)
	-15V±5%	mA	120(Max)	120(Max)
Weight		g	180	500

- 1: All angles are mechanical angles.
- 2: Values are at combination with a standard Harmonic driver

Main Application Target

- Metal working machines
- Measurement, analytical and test systems
- Optical machines
- Communication equipment
- Glass and ceramic manufacturing systems

**Please contact
 Harmonic Drive LLC
 for a detailed
 catalog of this
 product.**

MIT Series

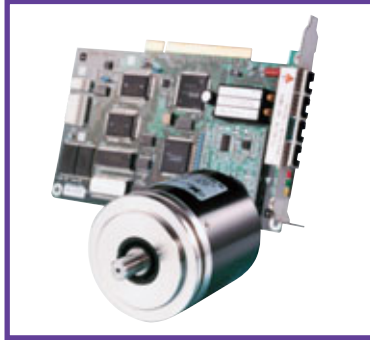

The MIT series are robust angle detection systems of a magnetic-induction type that can detect an absolute angle. The sensor output signals can be easily connected to a personal computer by a signal conversion circuit of PCI- or ISA-bus compatible.

•MIT Series Ratings

▶ Signal Converter Circuit

System	Magnetic induction, no commutator
Sensor Head	Stator contains 1-detector and 16-detector sets(Built-in as a set)
Moment of Inertia	0.523kg·cm ²
Permissible Speed	3000r/min
Permissible Radial Load	*Load input point is 5mm from tip of shaft
Permissible Thrust Load	49N(5kgf)
Bearing Life	60,000h
Weight	0.75kg
Protection Structure	IP67
Environmental Conditions	Operating temperature: -10 to +80°C/Storage temperature: -20 to +90°C. Operating and storage humidity: 20 to 85% RH (no condensation permitted).

▶ Signal Converter Circuit

Bus	PCI bus	ISA bus
Parallel Output	None	Parallel output connector
Maximum Number of Sensor Shafts	1	1
Output Signal Type	Absolute angle signal	
Output Signal Resolution	19 bits (524,288 split)	
Data Sampling	50μs interval	
Operating Voltage	5V±5%	
Maximum Current Consumption	800mA (When combined with detectors)	1200mA (When combined with detectors)
Recommended Personal Computer	DOS/V Compatibles (OS:Windows98,Windows2000)*1)	
Board Size	176.4(L)×107.0(H)mm	187.9(L)×121.9(H)mm
Environmental Conditions	Operating temperature: 0 to +55°C/Storage temperature: -20 to +70°C. Operating and storage humidity: 20 to 85% RH (no condensation permitted).	

* 1: "Windows" is a registered trademark of Microsoft Corp. of the United States.

Main Application Target

- Printing, bookbinding and paper processing machines
- Semiconductor manufacturing systems
- Glass and ceramic manufacturing systems

**Please contact
Harmonic Drive LLC
for a detailed
catalog of this
product.**

Micro Encoder Series



The micro encoder series are incremental encoders with the world's smallest resolution enabling a function for output of three short waves (wavelengths).

•Micro Encoder Series Ratings

Item	Model	MES-6-□□PC Number of Pulses	ME□□-9-□□PC Shaft Shape Number of Pulses • S: Single shaft • H: Hollow shaft
	Power Supply		DC5V±10%
Current Consumption		30mA or less (under no load)	40mA or less (under no load)
Detection System		Incremental	Incremental
Number of Output Pulses (Standard) [Number of Pulses/Number of Revolutions]		100 200 300 360	300 500 1000
Output Phases		A, B and Z phases	A, B and Z phases
Output Mode		Short wave (short wavelengths) open collector output	Short wave (Short wavelengths)
Maximum Response Frequency (Number of Response Pulses)		100kHz	100kHz
Output Phase Difference		Difference between A and B Phases $90^\circ \pm 45^\circ$ ($T/4 \pm T/8$), Z Phase $\pm T/2$ (See output waveform diagram.)	Difference between A and B Phases $90^\circ \pm 45^\circ$ ($T/4 \pm T/8$), Z Phase $\pm T/2$ (See output waveform diagram.)
Permissible Maximum Positioning Speed (Mechanical)		6000min ⁻¹	6000min ⁻¹
Operating Temperature and Humidity		0°C~60°C RH35%~90% No condensation permitted	0°C~60°C RH35%~90% No condensation permitted
Storage Ambient Temperature		-20°C~80°C	-20°C~80°C
Weight		5g	10g

Main Application Target

- Robots
- Humanoid robots
- Semiconductor manufacturing systems
- Measurement, analytical and test systems
- Optical machines
- Communication equipment

**Please contact
Harmonic Drive LLC
for a detailed
catalog of this
product.**

Servo Drivers



• Servo Driver Specifications

► AC Servo Digital Drivers HA-655 Series

Model	Incremental	HA-655-1-200 HA-655-1B-200	HA-655-2-200 HA-655-2B-200	HA-655-4-200 HA-655-4B-200	HA-655-1-100 HA-655-1B-100	HA-655-2-100 HA-655-2B-100	HA-655-4-100 HA-655-4B-100
	Absolute	—	HA-655-2A-200	HA-655-4A-200	—	HA-655-2A-100	HA-655-4A-100
Rated Current		1.0 A	2.4 A	1.4 A	1.0 A	2.4 A	4 A
Maximum Current		3.2 A	7.3 A	18.0 A	3.2 A	7.3 A	18.0 A
Power Supply	Main Circuit	AC200~240V (Single phase/3 phases) +10 ~-15%			AC100~115V (Single phase) +10 ~-15%		
	Control Circuit	AC100~115V (Single phase) or AC200~240V (Single phase) +10 ~ -15%			AC100~115V (Single phase) +10 ~ -15%		
Control System		Sine wave PWM control					
Control Mode		Position control, speed control					
Weight		1.5 k g	1.5 k g	1.7 k g	1.5 k g	1.5 k g	1.7 k g

► AC Servo Mono-Shaft Controller Drivers HA-675 Series

Model	Incremental	HA-675-1-200	HA-675-2-200	HA-675-4-200	HA-675-1-100	HA-675-2-100	HA-675-4-100
	Absolute	—	HA-675-2A-200	HA-675-4A-200	—	HA-675-2A-100	HA-675-4A-100
Rated Current		1.0A	2.4A	4.0A	1.0A	2.4A	4.0A
Maximum Current		3.2A	7.3A	18.0A	3.2A	7.3A	18.0A
Power Supply	Main Circuit	AC200~240V (Single phase/3 phases) +10 ~ -15%			AC100~115V (Single phase) +10 ~ -15%		
	Control Circuit	AC100~115V (Single phase) or AC200~240V (Single phase) +10 ~ -15%			AC100~115V (Single phase) +10 ~ -15%		
Control System		Sine wave PWM control					
Weight		1.5kg	1.5kg	1.7kg	1.5kg	1.5kg	1.7kg

► AC Servo Drivers HA-520 Series

Model	HA-520-1M-100	HA-520-1N-100	HA-520-1P-100	HA-520-1R-200	HA-520-3-200
Rated Current	1.0A	1.4A		1.4A	3A
Maximum Current	1.0A	1.5A	2.6A	4.2A	10A
Power Source Voltage	AC100V (Single phase) ±10%			AC200V (Single phase) ±10%	
Encoder	Incremental encoder (A, B and Z phase output), line driver system				
Control System	PWM control (control device: IPM), switching frequency: 12.5kHz				
Control Mode	Position control by pulse train input				
Weight	0.8kg	0.8kg	0.8kg	0.8kg	1.1kg

► DC Servo Drivers HS-360 Series

Model	HS-360-1A	HS-360-1B	HS-360-1C	HS-360-1D	HS-360-3
Rated Current	1.0A	1.4 A			3.2A
Maximum Current	1.0A	2.6A	3.7A	4.2A	10A
Power Source Voltage	AC100V (Single Phase) ±10%				
Encoder	Incremental encoder (A, B and Z phase output), line driver system				
Control System	PWM control (control device: IPM), switching frequency: 12.5kHz				
Control Mode	Position control by pulse train input				
Weight	0.8kg	0.8kg	0.8kg	0.8kg	1.1kg

► Common Specification to Servo Driver Series

Environmental Conditions	Operating temperature: 0 to 50°C • Storage temperature: -20 to +85°C • Operating and storage humidity: 95% RH or lower (No condensation permitted). Vibration resistance: 4.9m/S ² (frequency: 0 to 55Hz) • Shock resistance: 98m/S ² . No metal shaves and chips, no dust, no oil mist and no corrosive gas .
Structure/Mounting Direction	Totally closed, self cooling type/Base mount (Mounted on wall)

Combinations with Driver

• Combinations with Actuator and Driver

► Rotary Actuators

Series	Model No.	Combined Driver	
FHA-C mini	All models	HA-655-1-100/ (HA-655-1-200)	
		HA-675-1-100/ (HA-675-1-200)	
FHA-C	17	HA-655-2-200/ HA-655-2A-200 (HA-655-2-100/ HA-655-2A-100)	
		HA-675-2-200/ HA-675-2A-200 (HA-675-2-100/ HA-675-2A-100)	
	25	HA-655-2-200/ HA-655-2A-200 (HA-655-2-100/ HA-655-2A-100)	
		HA-675-2-200/ HA-675-2A-200 (HA-675-2-100/ HA-675-2A-100)	
	32	HA-655-4-200/ HA-655-4A-200 (HA-655-4-100/ HA-655-4A-100)	
		HA-675-4-200/ HA-675-4A-200 (HA-675-4-100/ HA-675-4A-100)	
	40	HA-655-4-200/ HA-655-4A-200 HA-675-4-200/ HA-675-4A-200	
	RSF	8	HA-520-1M-100
			HA-655-1B-100
		11	HA-520-1N-100
			HA-655-1B-100
		14	HA-520-1P-100
HA-655-1B-100			
17		HA-520-1R-200	
		HA-655-2B-200	
20	HA-520-1R-200		
	HA-655-2B-200		
25	HA-520-3-200		
	HA-655-2B-200		
32	HA-655-4B		
RH *	5	HS-360-1A-100	
	8	HS-360-1B-100	
	11	HS-360-1C-100	
	14	HS-360-1D-100	
RP	11		
	14		
	20		

► Galvano Optical Scanner

Series	Model No.	Combined Driver
LSA	All models	PSM-130

► Linear Actuators

Series	Model No.	Combined Driver
LA *	30	HS-360-1A-100
	32	HS-360-1A-100
LAH *	46	HS-360-1A-100
	80	
LBC	25	HA-655-2B-200
		HA-675-2B-200
LNP *		HS-360-1A-100

• The actuator will require a line driver type in case of a combination with the RH,LA,LAH,LNP series and a servo driver in the HS-360 series.

• Combined drivers enclosed in parentheses conform to the special specification.

Applications

Robots



Industrial robots
Amusement robots
Robot peripheral equipment

Indirect drive
Hand drive
Traveling shaft drive
Indexing table
Peripheral equipment

- CSG
- CSD
- CSF
- SHG
- SHF
- SHD
- HPG
- HP-F

- FHA-C
- RSF
- Micro Encoder

Humanoid Robots

Humanoid Robots

Indirect drive
Hand drive
Vision sensor drive
Torque sensing drive

- CSG
- CSD
- CSF
- SHG
- SHF
- SHD
- HPG

- Micro Encoder



Metal Machine Tools

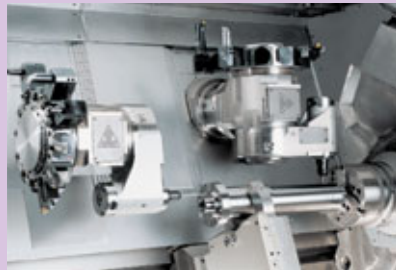

Machining centers
Turning centers
NC lathes
Work transfer systems
Grinders
EDM systems

Tool revolver drive
Tool changer drive
Tool magazine drive
Work positioning equipment
Rotary table drive
Tool positioning equipment drive
Direct transmission shaft drive
Shaft drive

- CSG
- CSF
- SHG
- SHF
- HPG
- FHA-C
- RSF
- LAH

Metal Working Machines

Bending machines
Rolling machines
Presses
Work transfer systems

Bent work drive
Work positioning machine drive
Work reversing machine

- SHG
- SHF
- HPG
- FHA-C
- RSF
- LSA



Printing, Bookbinding and Paper Processing Machines



Printing presses
Folding machines
Paper changing machines
Paper positioning machines
Paper machines

Tension controllers
Cutting blade positioning machines
Phase adjusting machines
Paper surface/back controlling machine
Roller position adjusting machines
Roller height adjustment

- CSG
- CSF
- SHG
- SHF
- FB
- FR
- FD
- HPG

- FHA-C
- MIT

Semiconductor Manufacturing Systems



Mask and reticle manufacturing equipment
Wafer fabrication systems
Wafer processing systems
Assembly systems
Inspection systems
Work transfer systems

Transfer systems
Positioning drive
Indexing tables
Direct transmission tables
Work reversing machines
Tension controllers
Hatch opening/closing drive

CSF	RH
SHD	RP-B
SHF	LA
HPG	LAH
HP-F	MIT
FHA-Cmini	Micro Encoder
FHA-C	
RSF	

Measurement, Analytical and Test Systems

Photometric equipment
Three-dimensional measuring instruments
Metal tensile test machines
Soil-column yield strength test machines

Transfer systems
Positioning drive
Prism positioning drive
Indexing tables
Direct transmission tables
Work reversing machines

CSF
SHF
HP-F
FHA-Cmini
RH
RP-B
LSA

Micro Encoder

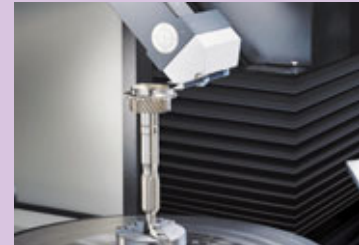

Medical Equipment



Three-dimensional manipulators
X-ray photographing and CT-NMR systems
X-ray film developing and take-off machines
Surgical operation assistant robots

Precision joint drive
Bed lifting and inclination drive
Positioning table drive

CSF
SHF
FHA-Cmini
RH
RP-B

Optical Machines

X-ray analytical systems
Optical component inspection systems
Laser oscillation machines
Optical measuring instruments
Surface inspection systems
Optical disc manufacturing systems
Laser markers

Positioning table drive
Lens positioning drive
Laser mirror drive
Prism drive
Probe drive
Sensor positioning drive

CSF
SHF
HP-F
FHA-Cmini
RH
RP-B
LSA
Micro Encoder

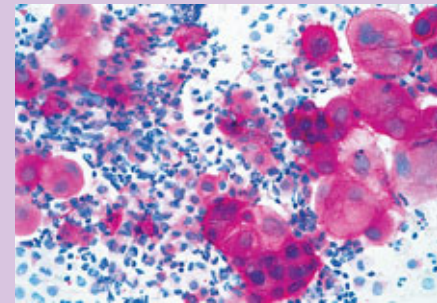

Telescopes



Condenser mirror adjusting mechanisms
Electromagnetic wave micrometer adjusting mechanisms
Primary mirror position control systems
Robot arms for maintenance servicing

X, Y, Z axis drive
Indirect drive mechanisms

CSF
SHF
HPG
FHA-Cmini
LA
LAH
LBC

Applications

Wood, Light Metal and Plastic Machine Tools



Woodworking machines
5-shaft machining centers
Large 3-dimension processing machines
Work transfer systems

- Milling head drive
- Tool revolver drive
- Tool changer drive
- Tool magazine drive
- Work positioning machines
- Rotary table drive
- Tool positioning machine drive
- Direct transmission shaft drive
- Shaft drive

- CSG
- CSF
- SHG
- SHF
- HPG
- FHA-Cmini
- FHA-C
- RSF
- LAH

Energy

Oil digging robot
Wind power electric power
Photovoltaics

- Digging angle positioning drive
- Propeller angle positioning drive
- Condensing board positioning drive

- CSF
- FR



Paper-making Machines



Paper-making machines
Corrugated fiberboard box making and printing machines

- Coating-process roller positioning drive
- Paper thickness adjusting mechanism drive
- Cutter knife positioning
- Cutter knife traveling drive

- CSF
- SHF
- HPG
- RH
- RP-B

Crating and Packaging Machines

Sealing machines
Label printing machines
Label attaching machines
Robots
Work transfer systems

- Shaft synchronizing drive
- Roll synchronizing drive
- Joint drive
- Trolley drive

- CSF
- SHF
- FB
- FR
- FD
- HPG
- FHA-C
- RSF

- RH



Flat Panel Display Manufacturing Systems



Array process equipment
Cell process equipment
Assembly process equipment
Work transfer systems

- Transfer systems
- Parts positioning drive
- Indexing tables
- Direct transmission tables
- Work reversing machines
- Tension controllers
- Hatch opening/closing drive
- Joint drive
- Trolley drive

- CSF
- SHF
- SHD
- HPG
- HP-F
- FHA-Cmini
- FHA-C
- RSF
- RH
- RP-B

- LA
- LAH

Communication Equipment



Antennas
Microphones
Cameras
Wavelength duplexers

Pan head drive
Lifter shaft drive
Prism drive

HPG
FHA-Cmini
FHA-C
RSF
RH
RP-B
LA
LSA

Micro Encoder

Printed Circuit Board Manufacturing Machines

Electronic component insertion machines
Cream solder printing machines
Dispensers
Board inspection systems
Transfer systems

Milling head drive
Tool revolver drive
Tool changer drive
Tool magazine drive
Work positioning machines
Rotary table drive
Tool positioning machine drive
Direct transmission shaft drive
Shaft drive

CSG
CSF
SHG
SHF
HPG
FHA-Cmini
FHA-C
RSF
LAH

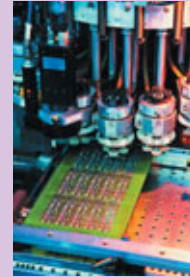

Space Equipment



Antennas
Solar cell paddles
Robots

Pan head drive
Joint drive
Traveling trolley drive

CSF
SHF
SHD

Aircraft

Flight simulators
Cargo handling and transfer systems
Reconnaissance cameras
Valves

Indirect drive of units
Pan head drive
Valve opening and closing
Valve positioning
Traveling trolley drive

CSF
HPG
FHA-Cmini
RH



Glass and Ceramic Manufacturing Systems



Ceramic forming machines
Glass polishing machines
Sheet glass cutting machines

Valve opening and closing
Valve positioning
Traveling trolley drive

CSF
SHF
HPG
FHA-Cmini
RSF
LSA
MIT



Robots



Humanoid Robots



**Printing, Bookbinding
and Paper**

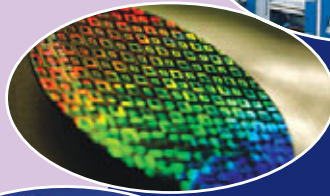

**Semiconductor Manufacturing
Systems**



Optical Machines



**Wood, Light Metal and Plastic
Machine Tools**



Paper-making Machines



**Flat Panel Display
Manufacturing Systems**



**Printed Circuit Board
Manufacturing Machines**



Aircraft



Metal Working Machine



Processing Machines



Measurement, Analytical and Test Systems



Medical Equipment



Telescopes



Energy



Crating and Packaging Machines



Communication Equipment



Space Equipment



Glass and Ceramic Manufacturing Systems

Primary Application Areas

All products are warranted to be free from design or manufacturing defects for a period of one year from the date of shipment. Such items will be repaired or replaced at the direction of Harmonic Drive LLC. The seller makes no warranty, express or implied, concerning the material to be furnished other than it shall be of the quality and specifications stated. The seller's liability for any breach is limited to the purchase price of the product. All efforts have been made to assure that the information in this catalog is complete and accurate. However, Harmonic Drive LLC is not liable for any errors, omissions or inaccuracies in the reported data. Harmonic Drive LLC reserves the right to change the product specifications, for any reason, without prior notice.

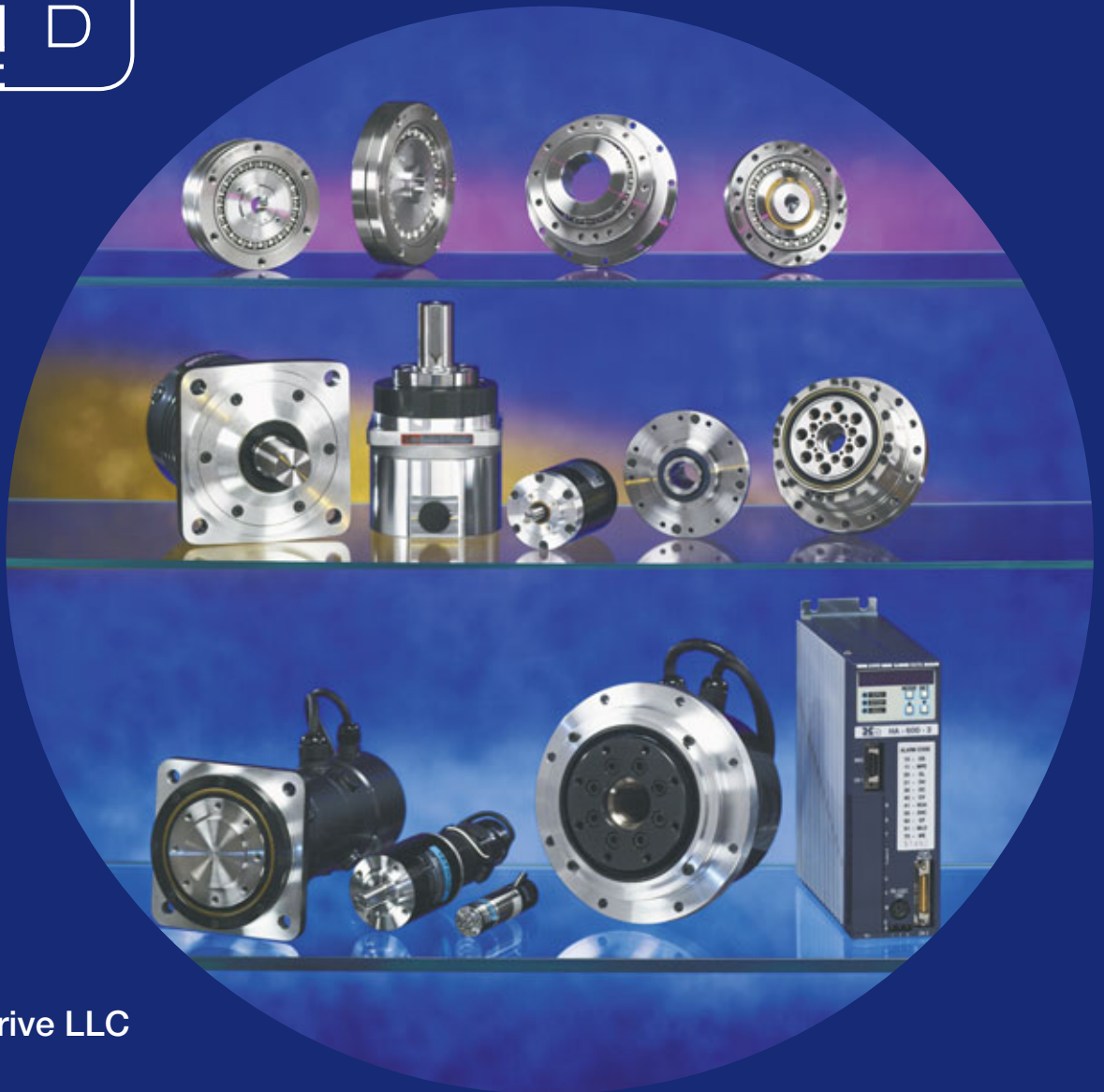

Harmonic Drive LLC

Boston

247 Lynnfield Street
Peabody, MA 01960

New York

89 Cabot Court
Hauppauge, NY 11788

800-921-3332

F: 978-532-9406

www.HarmonicDrive.net

Worldwide Locations:

Harmonic Drive Systems, Inc.
Minamiohi 6-25-3, Shinagawa-ku
Tokyo 140, Japan

Harmonic Drive AG
Hoenbergstr, 14
Limburg/Lahn, D-65555 Germany