

CHAPTER 9
HP-GL
Graphics Language

Table of Contents

Initialization and default setting instructions

| Instruction | Function | page |
|-------------|----------------------------|------|
| DF | Default Set Instruction | 6 |
| IN | Initialize Set Instruction | 7 |

Plot area and unit setting instructions

| Instruction | Function | page |
|-------------|--------------------------|------|
| IP | Scaling point | 8 |
| SC | Scale | 8 |
| IW | Input window | 9 |
| RO | Rotate coordinate system | 9 |
| PG | Page output | 9 |

Pen Control and Plot Instructions

| Instruction | Function | page |
|-------------|------------------------------|------|
| PU | Pen Up | 10 |
| PD | Pen Down | 11 |
| PA | Plot Absolute | 12 |
| PR | Relative Coordinate Pen Move | 13 |
| AA | Absolute Arc Plot | 14 |
| AR | Relative Arc Plot | 15 |
| CI | Circle | 16 |

The polygon group

| Instruction | Function | page |
|-------------|-------------------------|------|
| EA | Edge Absolute Rectangle | 18 |
| ER | Edge Relative Rectangle | 19 |
| EW | Edge Wedge | 20 |
| RA | Fill Absolute Rectangle | 21 |
| RR | Fill Relative Rectangle | 22 |
| WG | Fill Wedge | 23 |

Plot Function Instructions

| Instruction | Function | page |
|-------------|---------------|------|
| FT | Fill Type | 24 |
| LT | Line Type | 25 |
| PW | Pen Width | 25 |
| SM | Symbol Mode | 26 |
| SP | Select Pen | 26 |
| TL | Tick Length | 26 |
| XT | X Tick | 27 |
| YT | Y Tick | 27 |
| PT | Pen Thickness | 27 |

Character Plot Instructions

| Instruction | Function | page |
|-------------|-----------------------------|------|
| CS | Standard Set Definition | 28 |
| CA | Alternate Set Definition | 28 |
| SS | Select Standard Font | 29 |
| SA | Select Alternate Font | 29 |
| DT | Define Label Terminator | 29 |
| LB | Define Label | 30 |
| DI | Absolute Direction | 30 |
| DR | Relative Direction | 31 |
| CP | Character Plot | 31 |
| SI | Set Absolute Character Size | 32 |
| SR | Set Relative Character Size | 33 |
| SL | Set Character Slant | 33 |
| UC | User-defined Character | 34 |

Dual Context Extensions

| Instruction | Function | page |
|-------------|-------------------------|------|
| EscCRRO | Set HRC Off | 35 |
| EscCRRL | Set HRC to Light Level | 35 |
| EscCRRM | Set HRC to Medium Level | 35 |
| EscCRRD | Set HRC to Dark Level | 34 |

User Reset

| Instruction | Function | page |
|-------------|--------------------------|------|
| EscCR!#R | Restore to User Settings | 35 |

Factory Reset

| Instruction | Function | page |
|-------------|-----------------------------|------|
| EscCRFD | Restore to Factory Settings | 35 |

1. Introduction

The HP-GL graphics mode emulates 40 out of 56 instructions for the HP 7475A plotter made by Hewlett-Packard.

Default plotting measurement in the HP-GL graphics mode is 1/1016"(0.025mm).

1.1. HP-GL Syntax

A command consists of a two-letter instruction mnemonic, a parameter field (not needed for some instructions), and a terminator. Parameters following the instruction mnemonic must be separated from each other by at least a single space or comma.

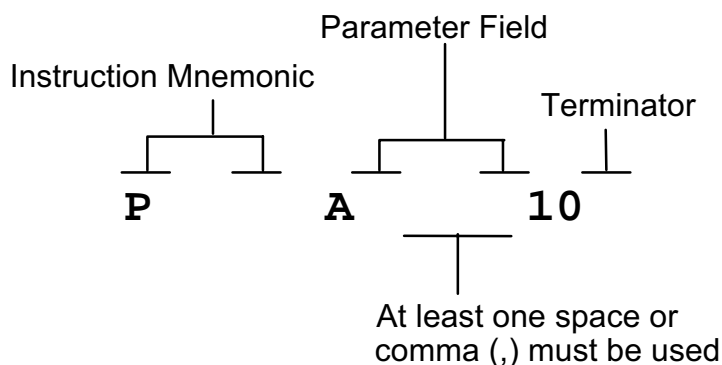

Numeric values used in the parameter field are in one of the following four formats.

- (1) Integer-integers between -2^{30} and $2^{30}-1$. Real numbers specified for a parameter that should be an integer are rounded to the nearest integer.
- (2) Clamped integer- integers between -32768 and 32767. Values outside this range are converted to the nearest integer within the range. Real numbers are rounded to the nearest integer.
- (3) Real - real numbers between -2^{30} and $2^{30}-1$.
- (4) Clamped Real - real numbers between -32768 and 32767. Values outside this range are converted to the nearest real number within the range.

1.2. Font Selection

Eighteen character sets compatible with the HP 7454A are available.

1.3. Coordinate System and Printing Area

1.3.1. Coordinate System

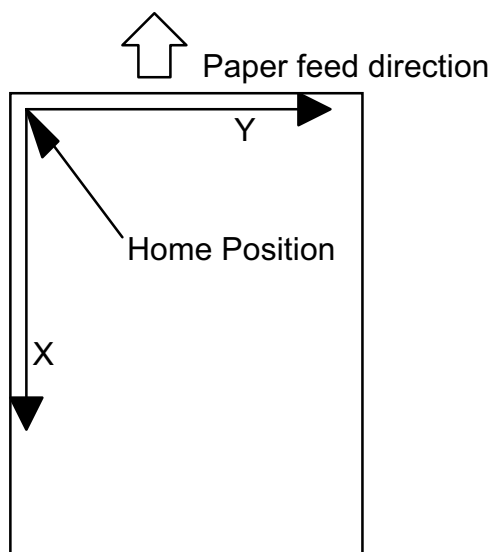

The home position is at the upper left corner of the area where printing is possible.

1.3.2. Printing Area

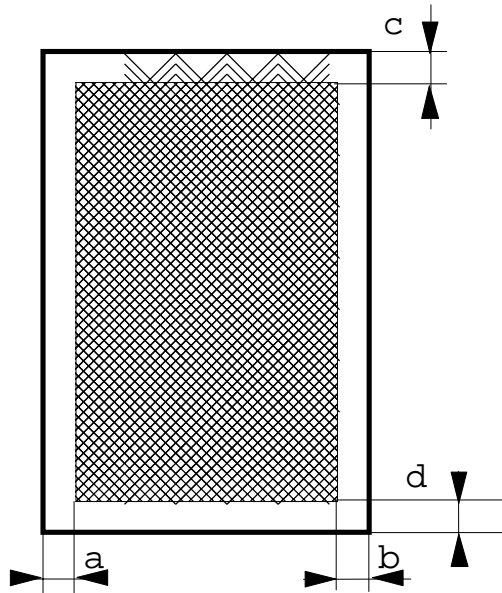

| | a | b | c | d | (mm) |
|--------|---|---|---|---|------|
| A4 | 4 | 5 | 5 | 5 | |
| Letter | 6 | 5 | 5 | 5 | |
| Legal | 6 | 5 | 5 | 5 | |

2. Commands

2.1. Initialization and Default Setting Instructions

DF - Default Set Instruction

DF [;]

- Returns the graphics mode to default conditions.
- The following are the default settings.

| Function | Equivalent Instruction | Condition |
|------------------------------|------------------------|---|
| Plot mode | PA; | Absolute plotting |
| Relative character direction | DR 1,0; | Horizontal |
| Line type | LT; | Solid line |
| Line pattern length | LT; | 4% of distance from P1 to P2 |
| Window | IW; | Set at limits of printable area according to paper size |
| Relative character size | SR; | Width=0.75% of P2x - P1x Height=1.5% of P2y - P1y |
| Symbol mode | SM; | Off |
| Tick length | TL; | X-axis: 0.5% of P2y - P1y Y-axis: 0.5% of P2x - P1x |
| Standard character set | CS 0; | Character set 0 |
| Alternate character set | CA 0; | Character set 0 |
| Character set | SS; | Standard character set selected |
| Character slant | SL 0; | 0 degrees |
| Scaling | SC; | Off |
| Label terminator | DT chr\$(3) | chr\$(3) |
| Chord angle | ---- | 5 degrees |
| Fill type | FT; | Bidirectional fill, type 1 |
| Fill distance | FT; | 1% of distance from P1 to P2 |
| Fill slant | FT; | 0 degrees |
| Pen Thickness | PT; | Set at 0.3 mm |

NOTE :The location of the scaling points(P1, P2) remains constant.

IN - Initialize Set Instruction**IN[;]**

- Returns the graphics mode to initial conditions;

| Function | Equivalent Instruction | Condition |
|------------------------------|-------------------------------|---|
| Plot mode | PA; | Absolute |
| Relative character direction | DR 1,0; | Horizontal |
| Line type | LT; | Solid line |
| Line pattern length | LT; | 4% of distance from P1 to P2 |
| Window | IW; | Set at limits of printable area according to paper size |
| Relative character size | SR; | Width=0.75% of P2x-P1x Height=1.5% of P2y-P1y |
| Symbol mode | SM; | Off |
| Tick length | TL; | X-axis: 0.5% of P2y-P1y Y-axis: 0.5% of P2x-P1x |
| Standard character set | CS 0; | Character set 0 |
| Alternate character set | CA 0; | Character set 0 |
| Character set | SS; | Standard character set selected |
| Character slant | SL 0; | 0 degrees |
| Scaling | SC ; | Off |
| Label terminator | DT chr\$(3) | chr\$(3) |
| Chord angle | ----- | 5 degrees |
| Fill type | FT; | Bi-directional fill, type 1 |
| Fill distance | FT; | 1% of distance from P1 to P2 |
| Fill slant | FT; | 0 degrees |
| Pen thickness | PT; | Set at 0.3 mm |
| Pen condition | PU; | Pen up |
| Rotation | RO; | Set at 0 degrees |
| Scaling points | IP; | Initialized according to paper size |

2.2. Plot area and unit setting instructions

| Instruction | Function |
|-------------|--------------------------|
| IP | Scaling point |
| SC | Scale |
| IW | Input window |
| RO | Rotate coordinate system |
| PG | Page output |

IP - Input Scaling Point

IP [P1x, P1y [,P2x, P2y]] [;]

P1x ; x coordinate of P1 P1y ; y coordinate of P1

P2x ; x coordinate of P2 P2y ; y coordinate of P2

- The coordinate values used are absolute values in graphics units.
- Sets the location of the scaling points(P1,P2).
- Coordinate values for P1x,P1y,P2x and P2y are given as integer numbers.
The IP instruction is ignored when the set coordinates are outside the print area.
- Using this instruction without a parameter field initializes the scaling points(P1,P2).
- P2x and P2y may be omitted. (If P2x and P2y are omitted, P2 is set automatically so as not to alter the distance between P1 and P2).

SC - Scale

SC Xmin, Xmax, Ymin, Ymax

Xmin ; X coordinate of P1 Xmax ; X coordinate of P2

Ymin ; Y coordinate of P1 Ymax ; Y coordinate of P2

- Sets the scale for the coordinates the user wants to establish.
- Coordinate values for Xmin, Xmax, Ymin, and Ymax are given as real numbers.
- Using this instruction without a parameter field turns the scaling off.
- The technical terms, user unit and graphics unit, used in this manual are defined as follows;

User unit : the unit of the coordinates set by the SC instruction
Graphics unit : the unit (1/1016 of an inch) of the coordinates not set by the SC instruction

```

10 '*** SCEX ***
20 LPRINT "IN; IP3000,2000,4500,3500;SP1;SC0,120,0,120;"
30 FOR T=0 TO 2*3.1416+3.1416/20 STEP 3.1416/20
40 X=COS(T)*100
50 Y=SIN(T)*100
60 LPRINT "PA";X;" , ";Y;" ;PD;"
70 NEXT T
80 LPRINT "PU;"
90 END

```

<Sample 61>

IW - Input Window

IW [X_1 , Y_1 , X_2 , Y_2] [;]

X1-Window lower left X coordinate

Y1-Window lower left Y coordinate

X2-Window upper right X coordinate

Y2-Window upper right Y coordinate

- This instruction sets the window inside which plotting can be performed.
- Graphic units are always used.
- Coordinate values for X1, Y1, X2, and Y2 are integer numbers from 0 to 32,767.
- The order of the pairs (X1, Y1) and (X2, Y2) may be reversed with no change in the window created: "IW X1, Y1, X2, Y2" is identical in effect to "IW X2, Y2, X1, Y1".
- Using this instruction without a parameter field releases limitations on the plot area.

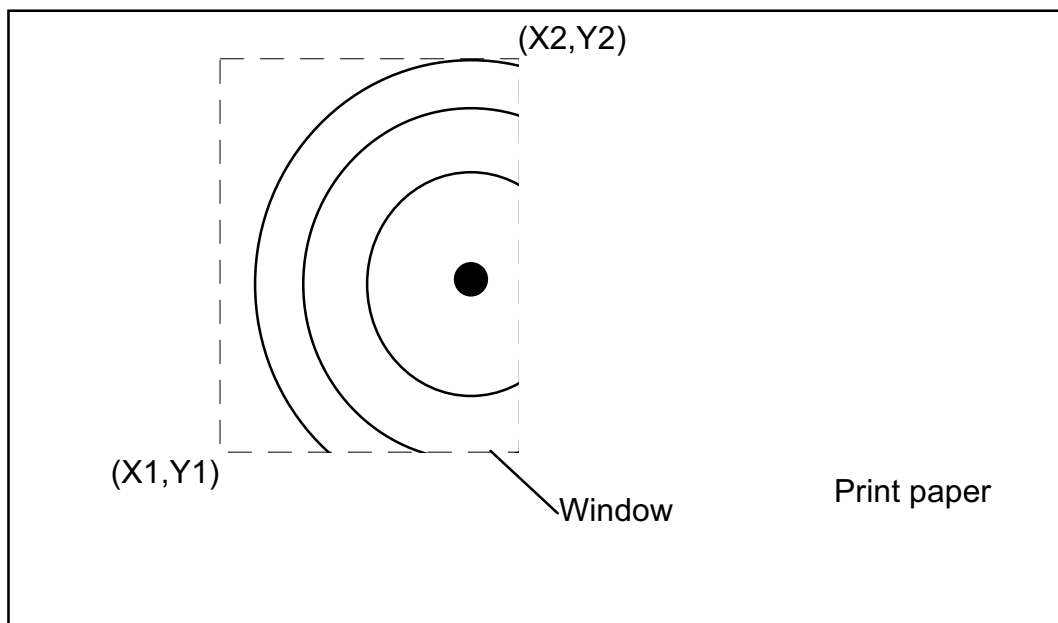

RO - Rotate coordinate system

RO [q] [;]

q : Angle in degrees through which the coordinate system is rotated.

- This instruction rotates the coordinate system.
- A value of 0 or 90 must be used for q .
- Using this instruction without a parameter field sets the rotation of the coordinate system to 0 degrees.

PG - Page feed

PG [;]

- Executes a page feed
- After page feeding, the cursor position return to the home position (0, 0).

2.3. Pen Control and Plot Instructions

| Instruction | Function |
|-------------|------------------------------|
| PU | Pen Up |
| PD | Pen Down |
| PA | Plot Absolute |
| PR | Relative Coordinate Pen Move |
| AA | Absolute Arc Plot |
| AR | Relative Arc Plot |
| CI | Circle |

PU - Pen Up

PU [X,Y [,...]] [;]

X ; X coordinate of the cursor movement destination

Y ; Y coordinate of the cursor movement destination

- X and Y are either relative or absolute, depending on whether a PA or a PR was the last plot command executed. The absolute coordinates are set as default.
- Moves the cursor to the specified coordinates after raising the pen.
- Using this instruction without a parameter field raises the pen without changing the cursor position.
- When scaling is on, user coordinates are used.
- Also, when scaling has been performed, the values for X and Y are real numbers.
- When scaling is off graphics units are used.
- When there is no scaling, the coordinates values for X and Y are integer numbers.

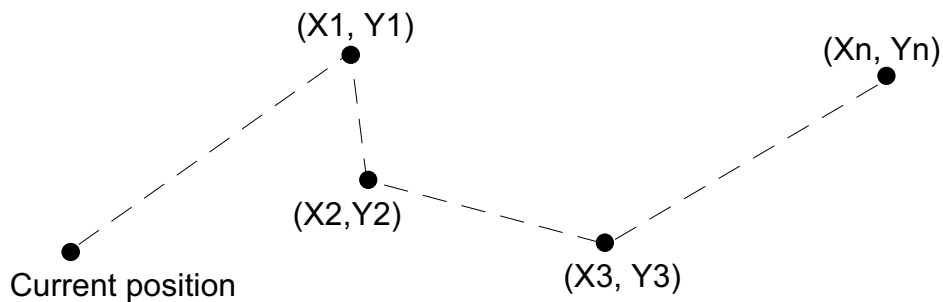

PD - Pen Down

PD [X, Y [, ...]] [;]

X ; X coordinate of the cursor movement destination

Y ; Y coordinate of the cursor movement destination

- X and Y are either relative or absolute, depending on whether a PA or a PR was the last plot command executed. The absolute coordinates are set as default.
- Moves the cursor to the specified coordinates after lowering the pen. (This plots a straight line.)
- Using this instruction without a parameter lowers the pen without changing the cursor position. (One dot is plotted.)
- When scaling has been performed, the cursor is moved by user coordinates.
- Also, when scaling has been performed, the values for X and Y are real numbers.
- When there is no scaling, the cursor is moved by absolute coordinates in graphics units.
- When there is no scaling, the coordinate values for X and Y are integer numbers.

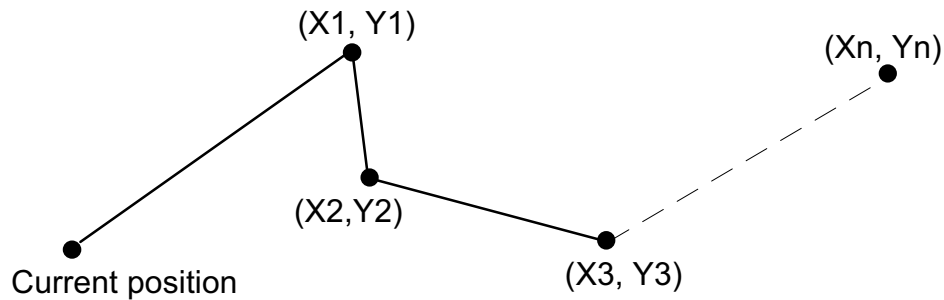

PA - Plot Absolute

PA [**X**, **Y** [, ...]] [**;**]

X ; X coordinate of the cursor movement destination

Y ; Y coordinate of the cursor movement destination

- X and Y are absolute values in user units or graphics units.
- Moves the cursor to the specified coordinates.
- Plots a straight line only when the pen is down.
- When scaling has been performed, the values for X and Y are integer numbers.
- When there is no scaling, the cursor is moved by absolute coordinates in graphics units.
- When there is no scaling, the coordinate values for X and Y are integer numbers.

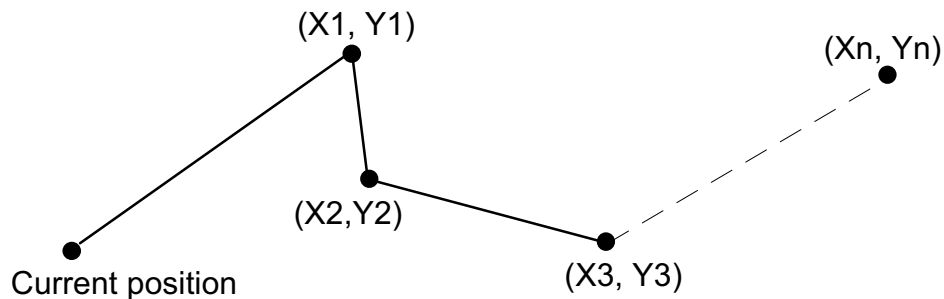

```

10 '*** PAEX1 ***
20 LPRINT "IN;SP1;"
30 LPRINT "PA2000,6000;PD0,6000,2000,7500,2000,6000;PU2500,6000;"
40 LPRINT "PAPD4500,6000,2500,7500,2500,6000;PU10365,500;"
50 END

```

<Sample 62>

```

10 ' *** PAEX2 ***
20 LPRINT "IN;SP1;SC0,100,0,100;"
30 LPRINT "PA50,30;PD25,30,50,50,50,30;PU55,30;"
40 LPRINT "PAPD80,30,55,50,55,30,PU;"
50 END

```

<Sample 63>

PR - Relative Coordinate Pen Move

PR [**X**, **Y** [, ...]] [**;**]

X ; X coordinate of the cursor movement destination

Y ; Y coordinate of the cursor movement destination

- Coordinates are relative to the current position in user units or graphics units.
- Plots a straight line only when the pen is down.
- When scaling has been performed, the cursor is moved by relative coordinates in user units.
- Also, when scaling has been performed, the values for X and Y are real numbers.
- When there is no scaling, the cursor is moved by relative coordinates in graphics units.
- When there is no scaling, the coordinate values for X and Y are integer numbers.

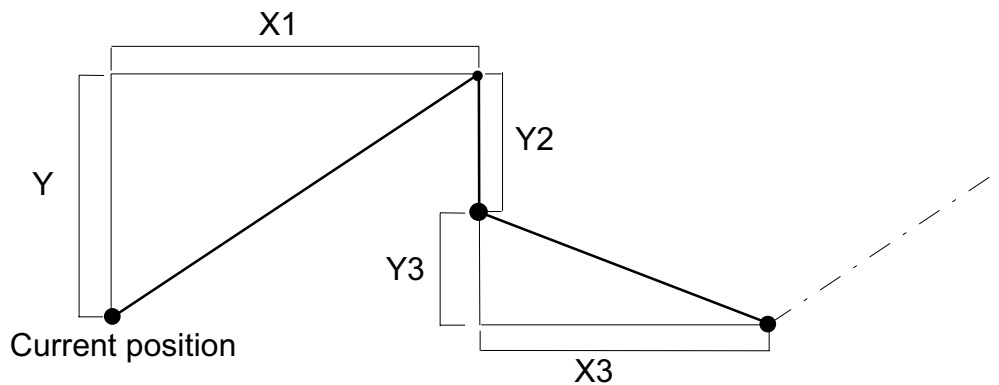

```

10 ' *** prex 1 ***
20 LPRINT "IN;SP1;"
30 LPRINT "PA5000,4500,;PDPR-2000,0,2000,2000,0,-2000;PU500,0;"
40 LPRINT "PD2000,0,-2000,2000,0,-2000;PU;"
50 END

```

<Sample 64>

AA - Draw Absolute Arc

AA [X, Y, qc [, qd]] [;]

X ; Arc centre X coordinate Y ; Arc centre Y coordinate

qc ; Arc angle in degrees qd ; Chord angle in degrees

- X and Y coordinates are absolute coordinates in user units or graphics units.
- Starting from the current position, plots an arc centred on the absolute coordinates X, Y having the specified arc angle and chord angle, with the radius being the distance between the current position and the point X,Y.
- After plotting, the cursor position moves to the plot end point.
- Plotting is performed only when the pen is down.
- When the pen is up, plotting is not performed, but the cursor position moves to the plot end point.
- When scaling has been performed, the cursor is moved by absolute coordinates in user units.
- Also, when scaling has been performed, the values for X and Y are real numbers.
- When there is no scaling, the cursor is moved by absolute coordinates in graphics units.
- When there is no scaling, the coordinate values for X and Y are integer number.
- The value for pc is a clamped real number.
- When qc is positive, counterclockwise plotting from the current point is performed.
- When qc is negative, plotting is made clockwise from the current position.
- The value for qd is a clamped real number.
- When qd is not specified, the chord angle is the default value (5 degrees).

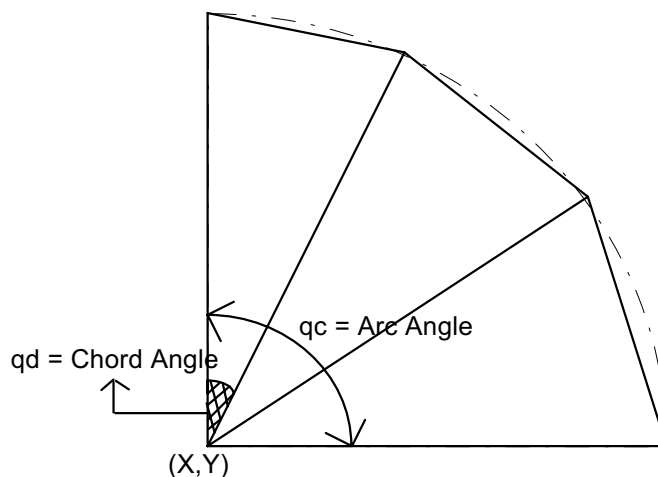

```

10 '*** AAEX ***
20 LPRINT "IN;SP1;IP2650,1325,7650,6325;"
30 LPRINT "SC0,100,0,100;"
40 LPRINT "PA0,30;"
50 LPRINT "PD;PA0,45;AA0,50,180;PA0,70;"
60 LPRINT "AA0,100,90;PA45,100;AA50,100,180;PA70,100;"
70 LPRINT "AA100,100,90;PA100,55;AA100,50,180;PA100,30;"
80 LPRINT "AA100,0,90;PA100,55;AA100,50,180;PA70,100;"
90 LPRINT "AA100,0,90;PA55,0;AA50,0,180;PA30,0;AA0,0,90;"
100 LPRINT "PU;PA50,50,CI20;"
110 END

```

<Sample 68>

AR - Draw Relative Arc

AR X, Y, qc(, qd)[;]

X ; Arc centre X coordinate Y ; Arc centre Y coordinate

qc ; Arc angle in degrees qd ; Chord angle in degrees

- X and Y coordinates are relative coordinates in user units or graphics units.
- Starting from the current cursor position the command plots an arc whose centre is at the relative coordinate position (X,Y) and which has the specified arc and chord angles. The radius of the arc is the distance between the current position and the point (X,Y).
- After plotting the cursor position changes to the plot end point.
- Plotting is performed only when the pen is down.
- When the pen is up, plotting is not performed, but the cursor position moves to the plot end point.
- When scaling has been performed, the cursor is moved by relative coordinates in user units.
- Also, when scaling has been performed, the values for X and Y are real numbers.
- When there is no scaling, the cursor is moved by relative coordinates in graphics units.
- When there is no scaling, the coordinate values for X and Y are integer numbers.
- The value for qc is a clamped real number.
- When qc is positive, counterclockwise plotting from the current point is performed.
- When qc is negative, plotting is made clockwise from the current position.
- The value for qd is a clamped real number.
- When qd is not specified, the chord angle is the default value (5 degrees).

```

10 '*** AREX1 ***
20 LPRINT "IN;SP1;IP2650,1325,7650,6325;"
30 LPRINT "SC-100,100,-100,100;"
40 LPRINT "PA-80,-80;PD;AR0,50,90;AR50,0,90;PU;"
50 END

```

<Sample 69>

```

10 ' *** AREX2 ***
20 LPRINT "IN;SP1;IP2650,1325,7650,6325;"
30 LPRINT "SC-100,100,-100,100;"
40 LPRINT "PA-100,70;PD;PR30,0;AR-, -70, -90;AR70,0,90;PR60,0;PU;"
50 END
100 END

```

<Sample 70>

CI - Circle Plot

CI r(, qd)[;]

r : Radius of circle (in user units or graphic units)

qd : Chord angle (in degrees)

- Plots a circle centred on the current position with a radius r and chord angle qd.
- After plotting, the cursor returns to its point of origin at the centre of the circle.
- Plotting is performed whether the pen is up or down.
- When scaling has been performed, the circle is plotted in user units.
- Also, when scaling has been performed, the value for r is a real number.
- When scaling is off, the circle is plotted in graphics units.
- When there is no scaling, the coordinate value for r is an integer number.
- When qd is not specified, the chord angle is the default value (5 degrees).

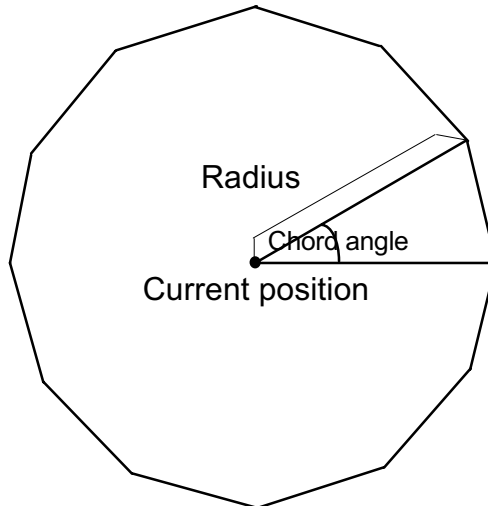

```
10 '*** CIEX1 ***
20 LPRINT "IN;SP1;IP2650,1325,7650,6325;"
30 LPRINT "SC-100,100,-100,100;"
40 LPRINT "PA-60,50;CI40,45;"
50 LPRINT "PA60,50;CI40,30;"
60 LPRINT "PA-60,-50;CI40,15;"
70 LPRINT "PA60,-50;CI40,5;"
80 END
```

<Sample 65>

```
10 '*** CIEX2 ***
20 LPRINT "IN;SP1;IP2650,1325,8650,7325;"
30 LPRINT "SC0,170,0,170;"
40 LPRINT "PA100,100;LT;CI10,5;LT0;CI-20,5;LT1;CI30,5;"
50 LPRINT "LT2;CI-40,5;LT3;CI50,5;LT4;CI-
60,5;LT5;CI70,5;LT6;CI80,5;"
60 END
```

<Sample 66>

```
10 '*** CIEX3 ***
20 LPRINT "IN;SP1;IP2650,1325,7650,6325;"
30 LPRINT "SC-1000,1000,-1000,1000;"
40 LPRINT "PA-800,800;"
50 GOSUB 130
60 LPRINT "PA200,800;"
70 GOSUB 130
80 LPRINT "PA-800,-200;"
90 GOSUB 130
100 LPRINT"PA200,-200;"
110 GOSUB 130
120 END
130 LPRINT "CI70;PR600,0;CI70;PR-300,-300;CI250;"
140 LPRINT "PR-300,-300;CI70;PR600,0;CI70;"
150 RETURN
```

<Sample 67>

2.4. The polygon group

| Instruction | Function |
|-------------|-------------------------|
| EA | Edge Absolute Rectangle |
| ER | Edge Relative Rectangle |
| EW | Edge Wedge |
| RA | Fill Absolute Rectangle |
| RR | Fill Relative Rectangle |
| WG | Fill Wedge |

EA - Edge Rectangle Absolute

EA X, Y[;]

X ; X coordinate of opposite angle for the rectangle

Y ; Y coordinate of opposite angle for the rectangle

- X and Y coordinates are absolute coordinates in user units or graphics units.
- Plots the rectangle formed by the current position and the opposite angle specified by X and Y.
- After plotting the cursor returns to its point of origin.
- Plotting is performed whether the pen is up or down.
- When scaling has been performed, the rectangle is plotted in user units.
- Also, when scaling has been performed, the values for X and Y are real numbers.
- When there is no scaling, the rectangle is plotted in graphics units.
- When there is no scaling, the coordinate values for X and Y are integer numbers.

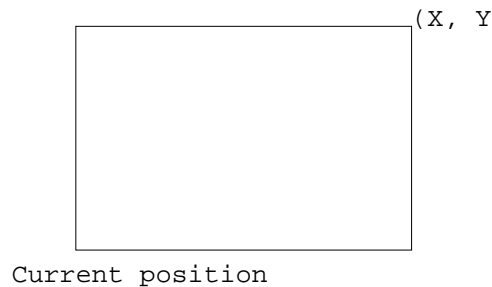

```

10 '*** EAEX ***
20 LPRINT "IN;SP1;PA7000,4000;"
30 LPRINT "PT.3;FT1;RA6000,3000;"
40 LPRINT "SP3,;EA6000,3000;"
50 LPRINT "SP4;FT3,100;RA8000,3000;"
60 LPRINT "SP3,;EA8000,3000;"
70 LPRINT "SP5;PT.3;FT2;RA8000,5000;"
80 LPRINT "SP3;EA8000,5000;"
90 LPRINT "SP6;FT4,100,45;RA6000,5000;"
100 LPRINT "SP3;EA6000,5000;PG"
110 END

```

<Sample 72>

ER - Edge Rectangle Relative**ER X, Y[;]**

X ; X coordinate of opposite angle for the rectangle

Y ; Y coordinate of opposite angle for the rectangle

- Coordinates are relative to the current position in user units or graphics units.
- Plots the rectangle formed by the current position and the opposite angle specified by X and Y.
- After plotting the cursor returns to its point of origin.
- Plotting is performed whether the pen is up or down.
- When scaling has been performed, the rectangle is plotted in user units.
- Also, when scaling has been performed, the values for X and Y are real numbers.
- When there is no scaling, the rectangle is plotted in graphics units.
- When there is no scaling, the coordinate values for X and Y are integer numbers.

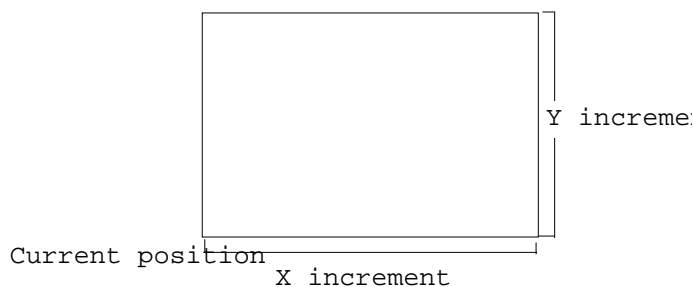

```

10 '*** EREX ***
20 LPRINT "IN;SP1;PA5000,5000;"
30 LPRINT "PT.3;FT1;RR500,500;"
40 LPRINT "SP3,;ER500,500;"
50 LPRINT "PR500,0"
60 LPRINT "SP4;FT3,;RR500,500;"
70 LPRINT "SP3,;ER500,500;"
80 LPRINT "PR0,500;"
90 LPRINT "SP5;PT.3;FT2;RR500,500;"
100 LPRINT "SP3;ER500,500;"
110 LPRINT "SP6;FT4,100,45;RR-500,500;"
120 LPRINT "SP3;ER-500,500;PG"
130 END

```

<Sample 74>

EW - Edge Wedge

EW *r, q1, qc* (*, qd*) [*; ;*]

r ; Radius in user units or graphics units *q1*; Start point angle

qc ; Arc angle *qd* ; Chord angle

- Plots a wedge centred on the current position with radius *r*, start point angle *q1*, arc angle *qc*, and chord angle *qd*.
- After plotting, the cursor returns to its point of origin.
- Plotting is performed whether the pen is up or down.
- When scaling has been performed, the circle is plotted in user units.
- Also, when scaling has been performed, the value for *r* is a real number.
- When there is no scaling, the circle is plotted in graphics units.
- When there is no scaling, the coordinate value for *r* is an integer number.
- The value for *q1* is a clamped real number.

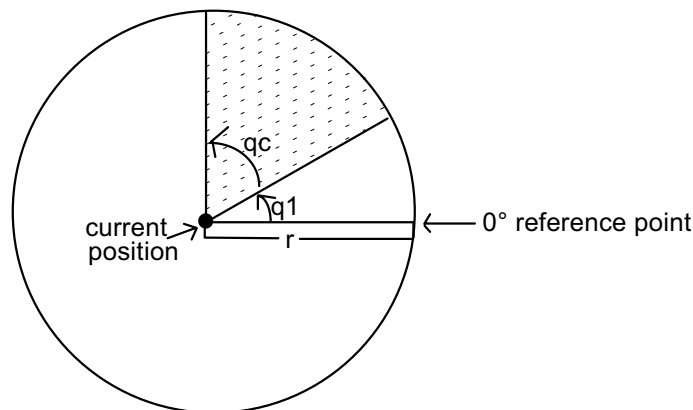

- *q1* specifies the wedge starting point related to the 0 degree reference point.
- When *q1* is positive, the positive direction of the X axis relative to the current position is set at 0 degrees, and the start point is sought in the counterclockwise direction. The opposite occurs when *q1* is negative: the negative X axis is set at 0 degrees, and the start point is sought by going clockwise.
- *qc* specifies the angle of the wedge in degrees.
- The value for *qc* is a real number.
- Plotting proceeds counterclockwise when *qc* is positive, and clockwise when negative.
- The value for *qd* is a clamped real number.
- When *qd* is not specified, the chord angle is the default value (5 degrees)

```

10 ' *** EWEX ***
20 LPRINT "IN;SP2;FT3,100;"
30 LPRINT "PA5000,4000;"
40 LPRINT "WG1250,90,180,5;"
50 LPRINT "SP3;EW1250,90,180,5;"
60 LPRINT "SP4,FT4,100,45;"
70 LPRINT "WG1250,270,120;"
80 LPRINT "SP3;EW1250,270,120;"
80 LPRINT "SP1;PT.3;FT1;"
100 LPRINT "WG1250,30,60;"
110 LPRINT "SP3;EW1250,30,60;PG;"
120 END

```

<Sample 76>

RA - Fill Rectangle Absolute

RA X, Y[;]

X ; X coordinate of opposite angle for the rectangle

Y ; Y coordinate of opposite angle for the rectangle

- X and Y coordinates are absolute coordinates in user units or graphics units.
- Fill in the rectangle formed by the current position and the opposite angle specified by X and Y.
- After plotting, the cursor returns to its point of origin.
- Plotting is performed whether the pen is up or down.
- When scaling has been performed, the rectangle is plotted in user units.
- Also, when scaling has been performed, the values for X and Y are real numbers.
- When there is no scaling, the rectangle is plotted in graphics units.
- When there is no scaling, the coordinate values for X and Y are integer numbers.

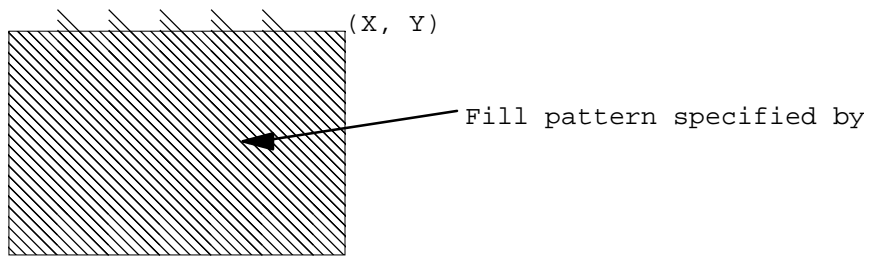

Current position

```

10 '*** RAEX ***
20 LPRINT "IN;SP1;PA5000,4000;"
30 LPRINT "PT.3;FT1;RA4250,3250;"
40 LPRINT "FT3,100;RA5750,3250;"
50 LPRINT "FT2;RA5750,4750;"
60 LPRINT "FT4,100,45;RA4250,4750;"
70 END

```

<Sample 71>

RR - Fill Rectangle Relative

RR X, Y[;]

X ; X coordinate of opposite angle for the rectangle

Y ; Y coordinate of opposite angle for the rectangle

- Coordinates are relative to the current position in user units or graphics units.
- Fill in the rectangle formed by the current position and the opposite angle specified by X and Y.
- After plotting the cursor returns to its point of origin.
- Plotting is performed whether the pen is up or down.
- When scaling has been performed, the rectangle is plotted in user units.
- Also, when scaling has been performed, the values for X and Y are real numbers.
- When there is no scaling, the rectangle is plotted in graphics units.
- When there is no scaling, the coordinate values for X and Y are integer numbers.

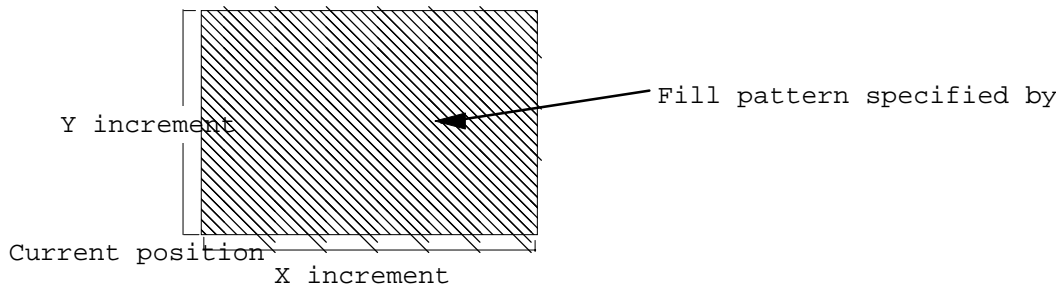

```

10 '*** PREX ***
20 LPRINT "IN;SP1;PA5000,5000;"
30 LPRINT "PT.3;FT1;RR500,500;"
35 LPRINT "PR500,0;"
40 LPRINT "FT3,70;RR500,500;"
45 LPRINT "PR0,500;"
50 LPRINT "FT2;RR500,500;"
60 LPRINT "FT4,70,45;RR-500,500;"
70 END

```

<Sample 73>

WG - Fill Wedge

WG *r, q1, qc(, qd)* [;]

r ; Radius in user units or graphics units *q1* ; Start point angle

qc ; Arc angle *qd* ; Chord angle

- Fill in a wedge centred on the current position with radius *r*, start point angle *q1*, arc angle *qc*, and chord angle *qd*.
- After plotting, the cursor returns to its point of origin.
- Plotting is performed whether the pen is up or down.
- When scaling has been performed, the circle is plotted in user units.
- Also, when scaling has been performed, the value for *r* is a real number.
- When there is no scaling, the circle is plotted in graphics units.
- When there is no scaling, the coordinate value for *r* is an integer number.
- The value for *q1* is a clamped real number.
- When *q1* is positive, the positive direction of the X axis relative to the current position is set at 0 degrees, and the start point is sought in the counterclockwise direction. The opposite occurs when *q1* is negative: the negative X axis is set at 0 degrees, and the start point is sought by going clockwise.
- The value for *qc* is a clamped real number.
- Plotting proceeds counterclockwise when *qc* is positive, and clockwise when negative.
- The value for *qd* is a clamped real number.
- When *qd* is not specified, the chord angle is the default value (5 degrees).

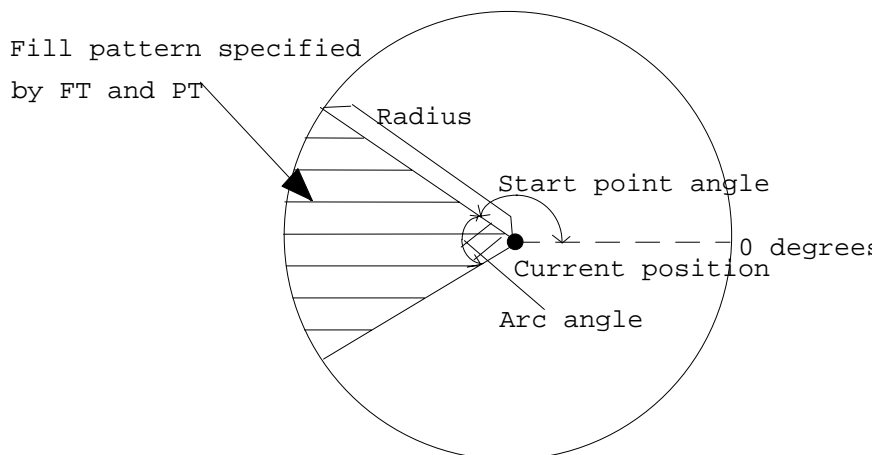

```

10 ' *** WGEX ***
20 LPRINT "IN;SP2;FT3,100;"
30 LPRINT "PA5000,4000;"
40 LPRINT "WG1250,90,180,5;"
50 LPRINT "SP4;FT4,100,45;"
60 LPRINT "WG1250,270,120;"
70 LPRINT "SP1;PT.3;FT1;"
80 LPRINT "WG1250,30,60;PG;"
90 END

```

<Sample 75>

2.5. Plot Function Instructions

| Instruction | Function |
|-------------|---------------|
| FT | Fill Type |
| LT | Line Type |
| PW | Pen Width |
| SM | Symbol Mode |
| SP | Select Pen |
| TL | Tick Length |
| XT | X Tick |
| YT | Y Tick |
| PT | Pen Thickness |

FT - Fill Type

FT [n [, d [, q]]] [;]

n : Fill type

d : Fill interval (interval between the parallel lines of the area being filled)

q : Fill angle (degrees)

- Sets the fill type, interval, and angle when filling an area.
- The value for n is a clamped integer number.

Solid lines (bidirectional fill)
 Solid lines (single direction fill)
 Parallel lines
 Crosshatching

- The fill interval when when n is 1 or 2 is the interval set by the pen thickness (PT) instruction.
- Any value given for d when n is 1 or 2 will be ignored.
- If d is omitted, the fill interval already specified will be used.
- If d is 0, the default value will be used (1% of distance from P1 to P2.)
- The value of d is a clamped real number .
- If q is omitted, the fill angle already specified will be used.
- The value of q is a clamped real number.

LT - Line Type Selection

LT [, n [, p]] [;]

n ; Line pattern number

p ; Line pattern length (percentage or millimeters of distance between P1 and P2)

- Specifies the line type and pattern length.
- When the n parameter field is omitted, a solid line is selected.
- When the p parameter field is omitted, the pattern length is 4% of the distance between P1 and P2 (default value).
- The value of n is a clamped integer number.
- The value of p is a clamped real number from 0.0000 to 127.9999.
- When p is omitted, the previously set line pattern length is used.

Default :Solid line

:For straight line, start and end points are plotted.

:For an arc, plotting takes place for every chord angle that is set.

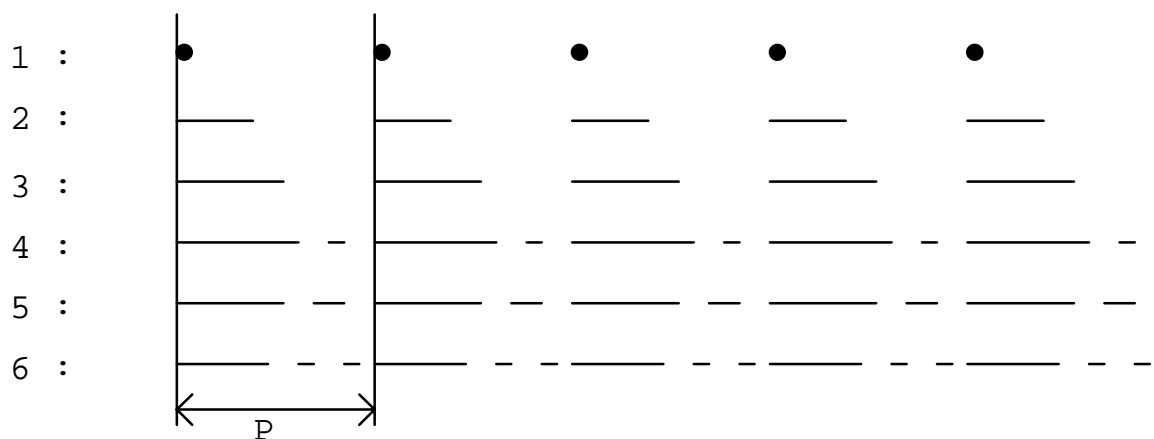

PW-Pen width

PW n [;]

w ; width (unit = 1/300 inch)

- This command specifies the width of the currently selected pen.
- The value of w is an integer number from 1 to 10.

SM - Symbol Mode**SM** *c* [;]*c* ; ASCII character or symbol code

- The command specifies the symbol to be drawn.
- When the PA,PR,PD or PU instruction is used, the specified symbol will be drawn at the end of each vector.
- The specified symbol will be drawn at the end of each vector even if the pen is up when the PA or PR instructions are used.
- Omitting the parameter field cancels the symbol mode.

```

10 '*** SMEX ***
20 LPRINT "IN;SP1;SM*;PA500,1500;"
30 LPRINT "PD600,1590,670,1860,850,1960,1320,1900,1940,2350:"
40 LPRINT "PU;SM;PA500,500;SM3;"
50 LPRINT "PA550,800,680,720,800,950,1150,1230,1870,1350;PU;"
60 LPRINT "SM;PA1850,600;PD;SMY;PA3000,1450;"
70 LPRINT "SMZ;PA3300,1150;SMX;PA1850,600;PU;"
80 END

```

<Sample 78>

SP - Select Pen**SP** [*n*] [;]*n* ; Pen number

- Selects the pen specified by the pen number.
- The value for *n* must be an integer from 0 to 6.

TL-Tick Length**TL** *l1* (, *l2*) [;]*l1*-Length of ticks in the positive X- and Y-axes*l2*-Length of ticks in the negative X- and Y-axes

- Tick length is a percentage of the vertical and horizontal distances between P1 and P2.
- Sets the length of tick marks for the XT and YT instructions.
- Values for *l1* and *l2* are clamped real numbers.
- When the parameter field is omitted, the default values for tick length are used (for both *l1* and *l2*, these are 0.5% of the horizontal and vertical distances between P1 and P2).

```

10 '*** TLEX ***
30 FOR I=1 TO 10
40 LPRINT "PR800,0;XT;"
50 NEXT I
60 LPRINT "TL;PU;PA300,279;PD;"
70 GOSUB 1000
80 LPRINT "TL1,0;PU;PA1100,279;PD;"
20 LPRINT "IN;PA300,279;SP2;PD;TL90;XT;" ;
90 GOSUB 1000
100 LPRINT "TL0,5;PU;PA1900,279;"
110 GOSUB 1000
120 LPRINT "PA300,6759;TL80;YT;PU;"
130 END
1000 '* SUBROUTINE DRAW TICKS *
1010 FOR J=1 TO 8
1020 LPRINT "PRO,720;YT;"
1030 NEXT J
1040 RETURN

```

<Sample 77>

XT - X-axis Tick

XT [;]

- Plots vertical tick marks as specified by the TL instruction from the current position.
- After plotting, the cursor returns to its point of origin.
- Plotting is performed whether the pen is up or down.

YT - Y-axis Tick

YT [;]

- Plots horizontal tick marks as specified by the TL instruction from the current position.
- After plotting, the cursor returns to its point of origin.
- Plotting is performed whether the pen is up or down.

```

10 '*** XTYTEX ***
20 LPRINT "IN;PA300,279;SP2;PD";
30 LPRINT "PR1300,0;XT;PR1300,0;XT;PU;"
40 END

```

PT - Pen Thickness Select

PT [d] [;]

d : Fill line interval (mm)

- Sets the line interval when filling in with solid lines.
- The value for d is a clamped number from 0.0000 to 5.0000.
- The default value (0.3 mm) is in effect when d is omitted.

2.6. Character Plot Instructions

| Instruction | Function |
|-------------|-----------------------------|
| CS | Standard Set Definition |
| CA | Alternate Set Definition |
| SS | Select Standard Font |
| SA | Select Alternate Font |
| DT | Define Label Terminator |
| LB | Define Label |
| DI | Absolute Direction |
| DR | Relative Direction |
| CP | Character Plot |
| SI | Set Absolute Character Size |
| SR | Set Relative Character Size |
| SL | Set Character Slant |
| UC | User-defined Character |

CS - Standard Character Set

CS *n* [;]

n ; Character set number(*)

- Specifies the standard character set.
- When the parameter field is omitted, character set 0 is specified.
- The value for *n* is a clamped integer number in the range of 0 to 4, 6 to 7, 9 or 30 to 39.

CA - Alternate Character Set

CA *n* [;]

n ; Character set number (*)

- Specifies the alternate character set.
- When the parameter field is omitted, character set 0 is specified.
- The value for *n* is a clamped integer number in the range of 0 to 4, 6 to 7, 9 or 30 to 39.

| n | Character Set |
|----------|------------------------|
| 0 | ANSI ASCII |
| 1 | 9825 Character Set |
| 2 | French/German |
| 3 | Scandinavian |
| 4 | Spanish/Latin American |
| 6 | JIS ASCII |
| 7 | ROMAN 8 Extensions |
| 9 | ISO IRV |
| 30 | ISO Swedish |
| 31 | ISO Swedish for Names |
| 32 | ISO Norway, Version 1 |
| 33 | ISO German |
| 34 | ISO French |
| 35 | ISO Kingdom |
| 36 | ISO Italian |
| 37 | ISO Spanish |
| 38 | ISO Portuguese |
| 39 | ISO Norway, Version 2 |

SS - Select Standard Character Set**SS [;]**

- Selects the standard character set specified by the CS instruction.

SA - Select Alternate Character Set**SA [;]**

- Selects the alternate character set specified by the CA instruction.

```

10 '*** SASSEX ***
20 LPRINT "PA5000,5000;"
30 LPRINT "SP2;CS4;CA9;SS;LBS_E_T_4";CHR$(14);"S_E_T_9";CHR$(3)
40 ENDØ

```

<Sample 79>

DT - Define Label Terminator**DT c [;]**

c : Character

- The specified character is used as the character plotter terminator.
- The character plot mode is cancelled by sending a terminator at the end of a character plot string.
- The parameter field used for this command must be only one character in length.
- The default value (chr\$(3)) is used when the parameter field is omitted.

```

10 '*** DTEX ***
20 LPRINT "IN;SP2;SC0,5000,0,5000;"
30 LPRINT "PA0,4500;LBDefault control character
ETX";CHR$(13);CHR$(3);
40 LPRINT "LBterminates by performing end-";CHR$(13);CHR$(3):
50 LPRINT "LBof-text function.";CHR$(3);
60 LPRINT "PA0,3500;DT@;LBPrinting characters
terminate,";CHR$(13):"@";
70 LPRINT "LBbut are also printed.@";
80 LPRINT "PA0,3000;DT";CHR$(13);";LBcontrol characters
terminate";CHR$(10);CHR$(13)
90 LPRINT "LBand perform their function.";CHR$(13)
100 END

```

<Sample 80>

LB - Character Plot

LB [cs] < terminator > [;]

cs : character string

- Plots character strings, numerical expressions, variables, etc.
- Plotting is performed whether the pen is up or down.
- After plotting, the cursor moves to the position of the next character.

```
10 '*** LBEX1 ***
20 LPRINT "SP2;PA1000,4000;"
30 X=30
40 LPRINT "LB",X,X+1,X+2,CHR$(3)
50 END
<Sample 81>
```

```
10 '*** LBEX2 ***
20 LPRINT "SP2;PA4000,5000;"
30 X=30
40 LPRINT "LB";X;X+1;X+2,CHR$(3)
70 END
<Sample 82>
```

```
10 '*** LBEX3 ***
20 LPRINT "SP2;PA5000,6000;"
30 X=30
40 LPRINT "LB";X;" ";X+1;" ";X+2,CHR$(3)
70 END
<Sample 83>
```

DI - Absolute Direction

DI [run, rise] [;]

run : X direction component

rise : Y direction component

- Specifies the character plot direction.
- Values for the run and rise are clamped real numbers.
- The instruction is ignored when the values for both run and rise are 0.
- When the parameter field is omitted, the default value (horizontal direction) is used.

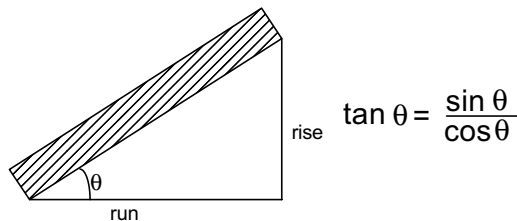

```
10 '*** DIEX ***
15 DEG=-45
16 RAD3.1416/180*DEG
20 LPRINT "IN;SP2;PA3050,4450;"
30 LPRINT "DI0,2;LB_*_1988";CHR$(3);"DI2,2;LB_*_1989";CHR$(3)
40 LPRINT "DI2,0;LB_*_1990";CHR$(3);"DI2,-2;LB_*_1991";CHR$(3)
50 LPRINT "DI0,-2;LB_*_1992";CHR$(3);"DI-2,-2;LB_*_1993";CHR$(3)
60 LPRINT "DI-2,0;LB_*_1994";CHR$(3);"DI-2,2;LB_*_1995";CHR$(3)
70 LPRINT
"PA3500,5350;DI",COS(0),SIN(0);"LB_*_2000";CHR$(13);CHR$(3);
80 LPRINT "DI",COS(RAD);SIN(RAD);"LB_RETURN
POINT";CHR$(13);CHR$(3)
```

90 END

<Sample 84>

DR - Relative Direction

DR [run, rise] [;]

run : X direction component
 rise : Y direction component

- Percentage of the distance in the X and Y directions between P1 and P2
- Specifies the character plot direction.
- Values for the run and rise are clamped real numbers.
- The instruction is ignored when values for both run and rise are 0.
- When the parameter field is omitted, the default value (horizontal direction) is used.

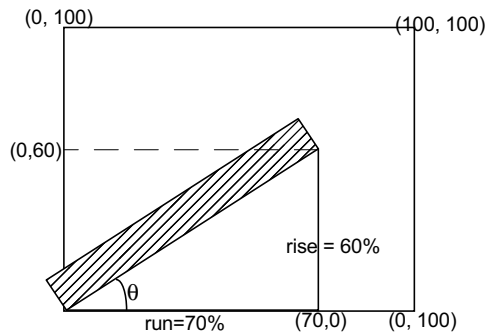

CP - Character Plot

CP X,Y [;]

X ; the number of text spaces the pen position is moved.
 Y ; the number of text lines the pen position is moved.

- Moves the cursor the specified number of characters.
- Values for X and Y are clamped real numbers.
- When the parameter field is omitted, the cursor is not moved along the X-axis but it is moved 1 character in the negative direction along the Y-axis (identical to executing CP 0, -1;).

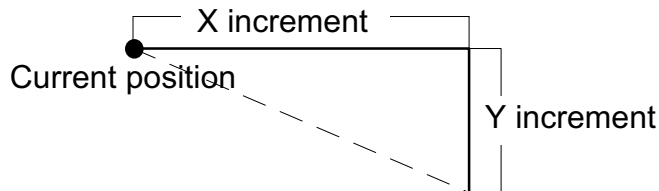

```

10 '*** CPEX ***
20 LPRINT "DF;SP1;PA1000,3000;PDPR3000,0;PU;PR-3000,0;"
30 LPRINT "CP5,.55;LBABOVE THE LINE";CHR$(3);"PA2000,3000;"
40 LPRINT "XT;CP0,-1.15;LBBELOW THE LINE";CHR$(13);CHR$(10);"AND
WITH A NEAT";CHR$(3)
50 LPRINT "CP;LBMARGIN";CHR$(3)
60 END
    
```

<Sample 85>

SI - Set Absolute Character Size

SI [*width*, *height*] [;]

width : the width in centimeters of printed characters

height : the height in centimeters of printed characters

- Specifies the size of characters to be plotted.
- Values for *width* and *height* are clamped real numbers.
- When the parameter field is omitted, the default values are used (*width*: 0.1879 cm, *height*: 0.2690 cm).

```
10 '*** SIEX1 ***
20 LPRINT "IN;SP1;PA1000,1000;"
30 LPRINT "SI,1.5;LBLASER";CHR$(3)
40 END
```

<Sample 86>

```
10 '*** SIEX2 ***
20 LPRINT "IN;SP1;PA5000,3000;"
30 LPRINT "SI-.35,.35;LBCHARACTER";CHR$(3)
40 END
```

<Sample 87>

```
10 '*** SIEX3 ***
20 LPRINT "IN;SP1;PA5000,3000;"
30 LPRINT "SI.35,-.35;LBCHARACTER";CHR$(3)
40 END
```

<Sample 88>

```
10 '*** SIEX4 ***
20 LPRINT "IN;SP1;PA5000,3000;"
30 LPRINT "SI-.35,-.35;LBCHARACTER";CHR$(3)
40 END
```

<Sample 89>

SR - Set Relative Character Size

SR [*width*, *height*] [;]

width ; the width of printed characters expressed as a percentage of the x-component of the distance between P1 and P2.

height ; the height of printed characters expressed as a percentage of the y-component of the distance between P1 and P2.

- Specifies the size of characters to be plotted.
- Values for *width* and *height* are clamped real numbers.
- When the parameter field is omitted, the default values are used (*width*: 0.7500%, *height*: 1.5000%).

```

10 ' *** SREX ***
20 LPRINT "IN;SP2;PA100,7000;LBDEFAULT SIZE";CHR$(3)
30 LPRINT "IP 2000,2000,6500,6500;PA100,6500;"
40 LPRINT "LBNEW P1 AND P2 CHANGE LABEL SIZE";CHR$(3);"SR5,5;"
50 LPRINT "PA100,6000;LBNEW SR INSTRUCTION";CHR$(13);CHR$(3);
60 LPRINT "LBCHANGE LABEL SIZE";CHR$(3);

```

<Sample 90>

SL - Character Slant

SL [*tan ϕ*] [;]

tan ϕ - tangent of character slant angle (ϕ)

- Specifies the slant of characters to be plotted.
- Value for $\tan\theta$ is a clamped real number.
- When the parameter field is omitted, the default value is used (0 degree character slant).

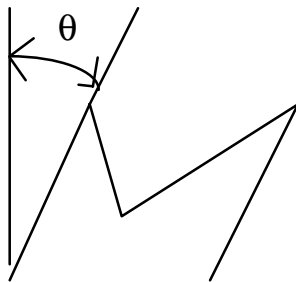

```

10 ' "**** SLEX ***
20 LPRINT "DF;SP1;SI1.3,1.3;PA100,6000;"
30 LPRINT "SL2;LBLASER";CHR$(3)
40 LPRINT "SL-2;PR3000,0;LBLASER";CHR$(3)
50 END

```

<Sample 91>

UC - User Defined Character

UC X1, Y1, X2, Y2..., Xn, Yn[;]

Xi : Number of grids in X direction

Yi : Number of grids in Y direction

- Draws user-generated character or symbol.
- Values for Xi and Yi are clamped real numbers.
- If a value between 99.0000 and 127.9999 is entered between (Xi, Yi) and (Xi+1, Yi+1), the pen will be lowered at that point.
- If a value between -128.0000 and -99.0000 is entered between (Xi, Yi) and (Xi+1, Yi+1), the pen will be raised at that point.

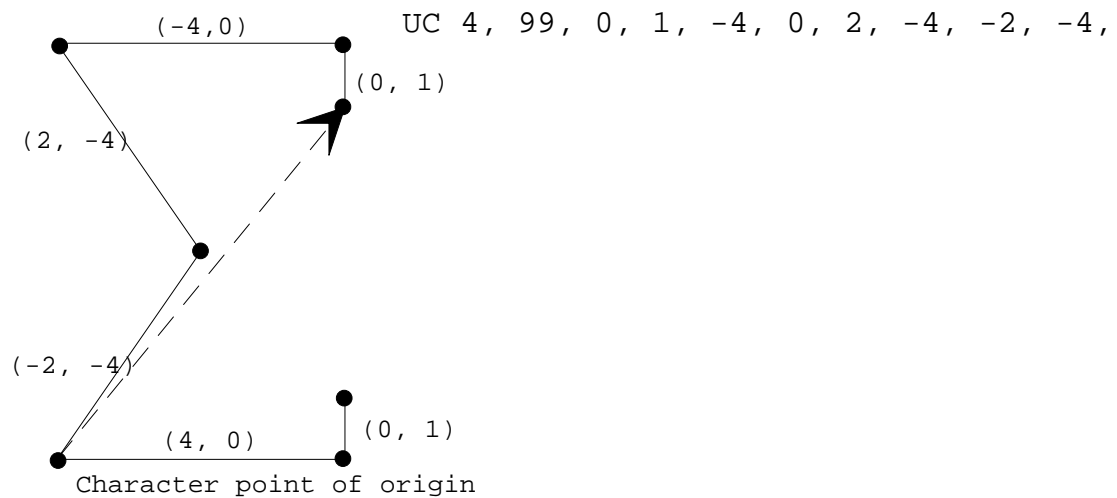

```

10 '*** UCX1 ***
20 LPRINT "IN;SP2;PA2000,2000;"
30 FOR AA=19 TO 89 STEP 10
40 A=AA/100
50 LPRINT "SI",A,A*1.7
60 LPRINT "UC4,7,99,0,1,-4,0,2,-4,-2,-4,4,0,0,1;"
70 NEXT AA
80 LPRINT "PA2000,3750;"
90 FOR BB=19 TO 89 STEP 10
100 B=BB/100
110 LPRINT "SI",B,B*1.7
120 LPRINT "LBE";CHR$(3)
130 NEXT BB
140 END

```

<Sample 92>

```

10 '*** UCX2 ***
20 LPRINT "SP1;PA3000,5000;SI.5,.8"
30 LPRINT "UC0,4,99,1.75,0,1.5,4,3,-8,3,8,3,-8,3,8,3,-
8,1.5,4,1.75,0;"
40 LPRINT "CP5,0;LB1000 ohms";CHR$(3)
50 END

```

<Sample 93>

```

10 '*** UCX2 ***
20 LPRINT "SP1;PA3000,4500;SI.5,.8"
30 LPRINT "UC0,8,99,3.5,0,3,8,6,-16,6,16,6,-16,6,16,6,-
16,3,8,3.5,0;"

```

Revision C 29.10.99

40 END

<Sample 94>

2.7. dual context extensions

Set High Resolution Control (Brother Original)

EscCRRO

- This command sets high resolution control off.

EscCRRL

- This command sets high resolution control light level.

EscCRRM

- This command sets high resolution control medium level.

EscCRRD

- This command sets high resolution control dark level.

USER RESET (Brother Original)

EscCR!#R

- # can be 0, 1 or 2.
- #0 indicates the current setting are restored.
- #1 indicates the user settings 1 are restored.
- #2 indicates the user settings 2 are restored.

FACTORY RESET (Brother Original)

EscCRFD

- This command causes a factory reset to be performed, restoring all the printer's factory default settings.
- You can also perform a factory reset using the printer's control panel (see the User Guide).