

Rosen Lite LED

LED LIGHTING

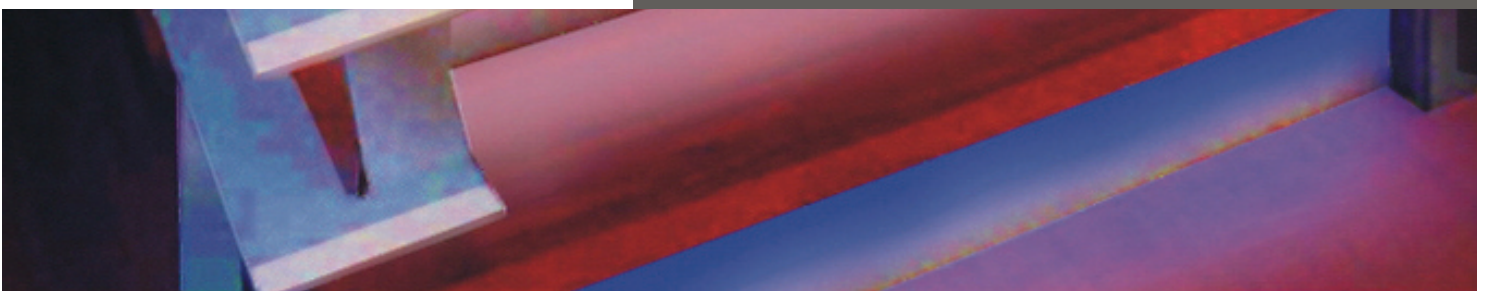

Versatile multi function LED lamp gives you the freedom to pick and choose desired LED head, arm and base, allowing continuity throughout your light scheme

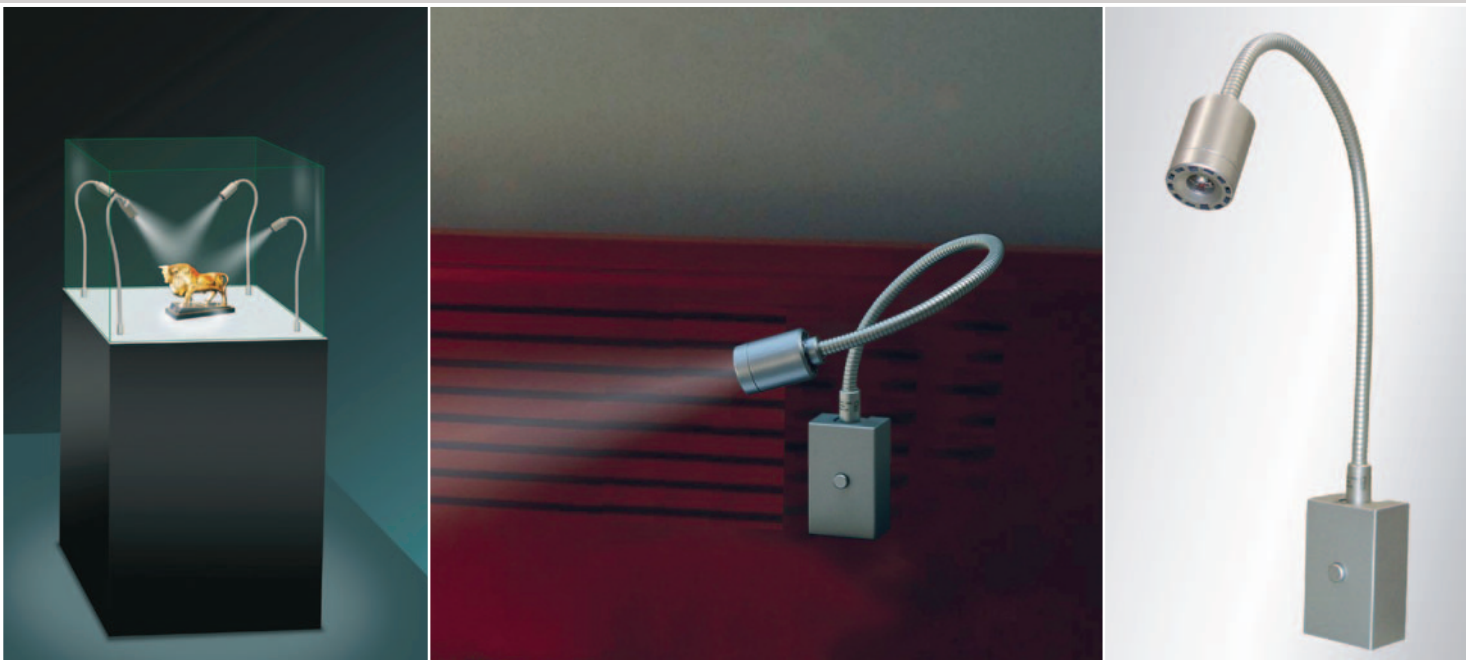

LD01SC



LD04SC



LD02SC



LD05SC



LD03SC



LD06SC

1W ALUMINIUM HIGH BRIGHTNESS LED HEADS

> Power requirement DC 3.5v 350ma (Nichia light source)

LD01SC (ø32mm x 55mm) **£55.99**

LD02SC (ø27mm x 66mm) **£59.49**

LD03SC (ø32mm x 66mm 15°-30°) **£57.99**

LD04SC (ø27mm x 77mm 15°-30°) **£59.49**

LD05SC (ø34mm x 80mm) **£62.99**

LD06SC (ø34mm x 80mm 15°) **£67.99**

LED COLOUR	LUMINOUS FLUX	TEMPERATURE COLOUR	BEAM ANGLE
COOL WHITE	36 - 42.8 lm	5600°K - 9000°K	45°



LD31SC



LD34SC



LD32SC



LD35SC



LD33SC



LD36SC

3W PLASTIC HIGH POWER LED HEADS

> Power requirement DC 3.5v 700ma (Edison light source)

LD31SC (ø34mm x 78mm) **£62.99**

LD32SC (ø34mm x 78mm) **£67.99**

LD33SC (ø34mm x 56mm) **£57.99**

LD34SC (ø34mm x 56mm) **£58.99**

LD35SC (ø34mm x 75mm) **£62.99**

LD36SC (ø37mm x 75mm) **£67.99**

LED COLOUR	LUMINOUS FLUX	TEMPERATURE COLOUR	BEAM ANGLE
COOL WHITE	110 - 140 lm	6500°K - 10000°K	120°

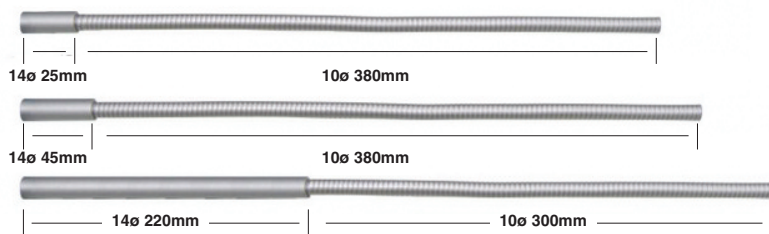

FAB

FAC

FAD

FLEXIBLE ARM

FAB (ø10mm x 380mm) **£14.99**

FAC (ø10mm x 60mm) **£14.99**

FAD (ø10mm x 43mm) **£16.29**



DIRECT MOUNT BASE

> Ideal for display lighting, suitable for display boxes

> Requires driver (see head)

DB01 (ø18mm x 61mm) Brass **£11.99**

DB02 (ø40mm x 8mm) Brass **£10.25**

DB03 (ø40mm x 60mm) Brass **£11.99**

DB04 (ø40mm x 43mm) Plastic **£6.79**



WALL TYPE BASE

> Ideal as bedside lamp

> Integral driver included

WB08 Rear cable entry (52 x 36 x 84mm) **£15.50**

WB09 Bottom cable entry (52 x 36 x 84mm) **£16.29**

WB10 Rear cable entry (52 x 36 x 84mm) **£19.49**



3W LED LAMP

- > High power 3w LED lamp
- > For standard MR16 fixtures
- > Edison light source

LD90111SC £65.99 (cool white)

LD90111SW £65.99 (warm white)

DIMENSIONS	LUMINOUS FLUX	COLOUR TEMP.	POWER	BEAM ANGLE
∅50mm x 43mm	110 - 140 lm	6500°k - 10000°k	3w 12v wound transformer needed	11°

1W LED LAMP WITH FOCUS

- > High power 1w cool white LED lamp
- > Focus adjustable 15° (sharp edge) to 30° (soft edge)
- > For MR11/MR16 fixtures
- > Nichia light source (Japan)

LD90212SC £49.99 (cool white)

LD90212SW £49.99 (warm white)

DIMENSIONS	LUMINOUS FLUX	COLOUR TEMP.	POWER	BEAM ANGLE
∅27mm x 53mm	36 - 42.8lm (CW) 30.3 - 36lm (WW)	5600°k-9000°k (CW) 2500°k-3175°k (WW)	1w 12v wound transformer needed	15°-30°

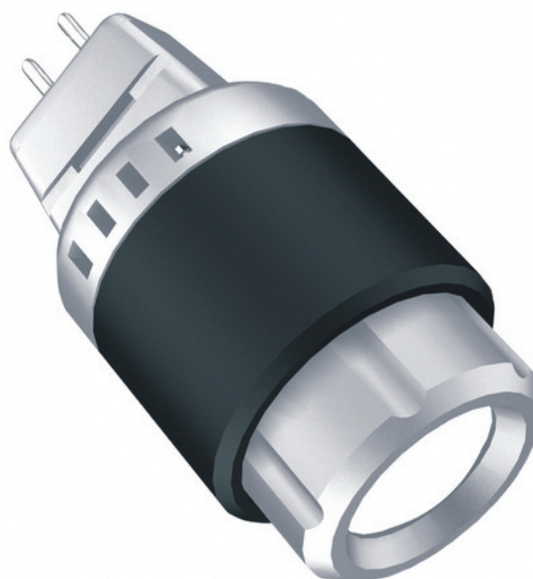



FOCUS ADJUSTABLE SWIVEL LED

- > High power 1w LED lamp
- > Light source Nichia (Japan)
- > Requires driver (see page 151)
- > Focus adjustable 15° (sharp edge) to 30° (soft edge)
- > Available in warm white(w) & cool white(c)

LD40131W (white) £28.00

LD40131S (silver) £28.00

DIMENSIONS	LUMINOUS FLUX	COLOUR TEMP.	POWER	BEAM ANGLE
od.ø67mm x d.50mm cutout.ø62mm	36-42.8lm (CW) 30.3-36lm (WW)	5600°k-9000°k (CW) 2500°k-3175°k (WW)	DC 3.5v 350ma constant current driver	15°-30°

MINI 1W LED LAMP WITH FOCUS

- > High power 1w LED lamp
- > Light source Nichia (Japan)
- > Requires driver (see page 151)
- > Focus adjustable 15° (sharp edge) to 30° (soft edge)
- > Available in warm white(w) & cool white(c)

LD40121S (silver) £28.00

LD40121B (black) £28.00

DIMENSIONS	LUMINOUS FLUX	COLOUR TEMP.	POWER	BEAM ANGLE
od.ø30mm x d.50mm cutout.ø28mm	36-42.8lm (CW) 30.3-36lm (WW)	5600°k-9000°k (CW) 2500°k-3175°k (WW)	DC 3.5v 350ma constant current driver	15°-30°



Adjustable Focus

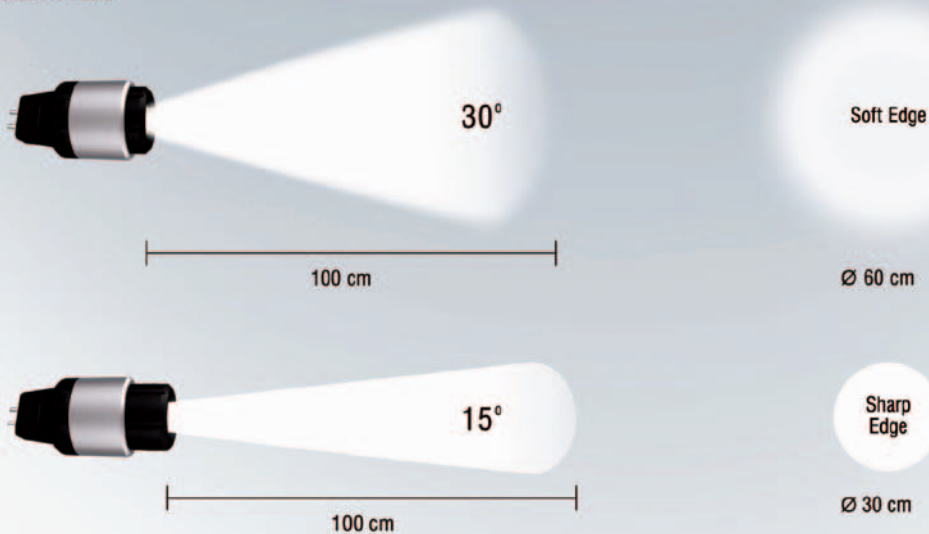





UNDER CABINET LED

- > High power 1w x3 cool white LED under cabinet lamp
- > Requires driver (see page 151)
- > Nichia light source (Japan)

LD40302SC £61.99 (cool white)

DIMENSIONS	LUMINOUS FLUX	COLOUR TEMP.	POWER	BEAM ANGLE
 ø68mm  12mm 75mm	108 - 128.4lm	5600°k-9000°k	DC 10.5v 350ma	n/a



LD40336SC

- > High power 1w x6 cool white LED swivel downlight
 - > Power requirement DC 21v 350ma constant current driver (see page 151)
 - > Edison light source
- £139.98 (cool white)**

DIMENSIONS	LUMINOUS FLUX	COLOUR TEMP.	POWER	BEAM ANGLE
ø104mm x 25.6mm	300 - 390lm	5650°k-6300°k	DC 21v 350ma	45°

LD40332SC

- > High power 1w x3 cool white LED swivel downlight
 - > Power requirement DC 10.5v 350ma constant current driver (see page 151)
 - > Edison light source
- £69.99 (cool white)**

DIMENSIONS	LUMINOUS FLUX	COLOUR TEMP.	POWER	BEAM ANGLE
ø70mm x 25.1mm	150 - 195lm	5650°k-6300°k	DC 10.5v 350ma	15°



LD40330SC

- > High power 3w cool white LED swivel downlight
 - > Power requirement DC 3.5v 700ma constant current driver (see page 151)
 - > Edison light source
- £47.99 (cool white)**

DIMENSIONS	LUMINOUS FLUX	COLOUR TEMP.	POWER	BEAM ANGLE
ø53mm x 42.5mm	110 - 140lm	5650°k-6300°k	DC 3.5v 700ma	11°



LD40320SC

- > High power 3w cool white LED fixed downlight
 - > Power requirement DC 3.5v 700ma constant current driver (see page 151)
 - > Edison light source
- £41.95 (cool white)**

DIMENSIONS	LUMINOUS FLUX	COLOUR TEMP.	POWER	BEAM ANGLE
ø40mm x 42.5mm	110 - 140lm	5650°k-6300°k	DC 3.5v 700ma	120°



50-60 lm per LED (typical 144lm per 3w head) 5650°k - 6300°k

G4-001

- > Steel and die cast aluminium construction
- > 3x 1w cool white LED downlight
- > Angle 120°, lens 35°-45°
- > Lumen 50 lm

£54.99



DIMENSIONS

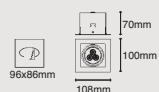

POWER

1x (3x1w)
max 10.5v

CLASS



FINISHES

Silver

G4-002

- > Steel and die cast aluminium construction
- > 2 head 3x 1w cool white LED downlight
- > Angle 120°, lens 35°-45°
- > Lumen 50 lm

£99.99



DIMENSIONS

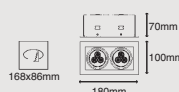

POWER

2x (3x1w)
max 21v

CLASS



FINISHES

Silver

G4-003

- > Steel and die cast aluminium construction
- > 3 head 3x 1w cool white LED downlight
- > Angle 120°, lens 35°-45°
- > Lumen 50 lm

£149.00



DIMENSIONS

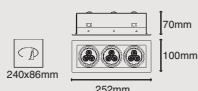

POWER

3x (3x1w)
max 31.5v

CLASS



FINISHES

Silver

9A 073-Z00

- > Driver for this range of downlights
- > Supplied with plug-in connectors to allow for quick installation

£22.99



DIMENSIONS

POWER

31.5v/350ma
9x1w max.
6x 1w 21v min.

CLASS



FINISHES

Silver

DESIGNED TO BE USED ON ROSENLITE ALUMINIUM, MINI STRUCTURE, STRUCTURE TRACK & TRANSPARENT TRACK.

See pages 175-180





Powered by 12v wound transformer to power these LED's

H1-008/009/010 are not recommended to be mounted on transparent track



H1-003

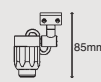

- > Steel and die cast aluminium construction
 - > 1w cool white LED track spot
 - > Adjustable lens 15°-30°
 - > Nichia light source (Japan)
- £46.20**

DIMENSIONS	LUMINOUS FLUX	COLOUR TEMP.	CLASS	FINISHES
 85mm	36-42.8lm	5600°k-9000°k	CE 	Silver



H1-005

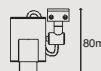

- > Steel and die cast aluminium construction
 - > 1w cool white LED track spot
 - > Adjustable lens 15°-30°
 - > Nichia light source (Japan)
- £46.20**

DIMENSIONS	LUMINOUS FLUX	COLOUR TEMP.	CLASS	FINISHES
 80mm	36-42.8lm	5600°k-9000°k	CE 	Silver



H1-004

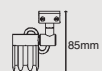

- > Steel and die cast aluminium construction
 - > 1w cool white LED track spot
 - > Edison light source
- £43.45**

DIMENSIONS	LUMINOUS FLUX	COLOUR TEMP.	CLASS	FINISHES
 85mm	50-60lm	5650°k-6300°k	CE 	Silver



H1-006



- > Steel and die cast aluminium construction
 - > 1w cool white LED track spot
 - > Edison light source
- £43.45**

DIMENSIONS	LUMINOUS FLUX	COLOUR TEMP.	CLASS	FINISHES
 74mm	50-60lm	5650°k-6300°k	CE 	Silver



H1-009



- > Steel and die cast aluminium construction
 - > 1w cool white LED track spot
 - > Adjustable lens 15°-30°
 - > Nichia light source (Japan)
- £38.50**

DIMENSIONS	LUMINOUS FLUX	COLOUR TEMP.	CLASS	FINISHES
 84mm	36-42.8lm	5600°k-9000°k	CE 	Silver



H1-008



- > Steel and die cast aluminium construction
 - > 1w cool white LED track spot
 - > Edison light source
- £38.50**

DIMENSIONS	LUMINOUS FLUX	COLOUR TEMP.	CLASS	FINISHES
 76mm	50-60lm	5650°k-6300°k	CE 	Silver



H1-010

- > Steel and die cast aluminium construction
 - > 1w cool white LED track spot
 - > Edison light source
- £38.50**

DIMENSIONS	LUMINOUS FLUX	COLOUR TEMP.	CLASS	FINISHES
 76mm	50-60lm	5650°k-6300°k	CE 	Silver

DESIGNED TO BE USED ON ROSENLITE ELEMENTS U & H TYPE TRACK.

See pages 208(U) & 211(H)



Can also be used on all Element adapters, allowing them to be mounted on direct mounts, canopies & wire systems.
Powered by 12v wound transformer



LD35100SC

- > Die cast aluminium construction
- > 1w x3 cool white LED track spot
- > Edison light source
- > ø57mm diameter beam angle 15°

£89.50

LUMINOUS FLUX	COLOUR TEMP.	CLASS	FINISHES
50-60lm per LED	5650°k-10000°k	CE	Silver

LD35101SC

- > Die cast aluminium construction
- > 1w x6 cool white LED track spot
- > Edison light source
- > ø81mm diameter beam angle 15°

£129.90

LUMINOUS FLUX	COLOUR TEMP.	CLASS	FINISHES
50-60lm per LED	5650°k-10000°k	CE	Silver



J2-003

- > Steel and die cast aluminium construction
- > 2x 1w cool white LED surface mounted ceiling fitting
- > Adjustable lens 15°-30°
- > Integral driver included
- > Nichia light source (Japan)

£79.98

DIMENSIONS	LUMINOUS FLUX	COLOUR TEMP.	CLASS	FINISHES
	36-42.8lm per LED	5600°k-9000°k	CE	Silver



W1-001

- > Steel and die cast aluminium construction
- > 1w cool white LED surface mounted wall fitting
- > Integral driver included
- > Edison light source

£39.98

DIMENSIONS	LUMINOUS FLUX	COLOUR TEMP.	CLASS	FINISHES
	50-60lm	5650°k-6300°k	CE	Silver



W2-001

- > Steel and die cast aluminium construction
- > 2x 1w cool white LED surface mounted wall fitting
- > Integral driver included
- > Edison light source

£63.49

DIMENSIONS	LUMINOUS FLUX	COLOUR TEMP.	CLASS	FINISHES
	50-60lm per LED	5650°k-6300°k	CE	Silver

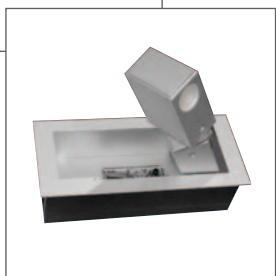

3W 'HIDE-AWAY' FITTING

- > Contemporary LED fitting which can be hidden away when not in use
- > Blue indicator light on switch
- > Driver included
- > Edison light source

LD83500S (Left) £174.99

LD83501S (right) £174.99

DIMENSIONS	LUMINOUS FLUX	COLOUR TEMP.	CLASS	FINISHES
185 x 82 x 57.6mm cutout: 175 x 72 x 50mm	110-140lm	5650°k-6300°k	CE	Silver



POWER SUPPLY/CONTROLLERS

- > 230v 50/60Hz power supply unit
- > Output DC 24v 2.5A 60w

LD98906 £39.90

- > Simple controller, 7 colour changing at 3 minute cycle
- > Input DC 12-24v

LD98900 £31.99

- > RGB IR constant colour changing controller
- > Input DC 12-24v
- > 60w max load

LD98904 £186.90

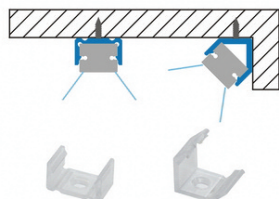

LD94010

LD94020

OPTIONAL CLIPS

- > 2 Directional under cabinet mounting clip

LD94010 (2pcs/pack) £4.90

LD94020 (2pcs/pack) £4.90



WALL MOUNTED RGB LED STRIPS

- > IP55 wall mounted LED strip
- > 2 million additive RGB colour range, continuously variable intensity output range
- > Lamp source SMT RGB (3 in 1) 3w LED
- > Power requirement 24v DC

CODE & LENGTH	No LED's	POWER	LUMINOUS FLUX	NTP
LD71110 374mm	14	5.1w	27lm	£145.98
LD71410 1124mm	44	13w	85lm	£295.98



DIRECT FIX RGB LED STRIPS

- > IP55 under cabinet LED strip
- > 2 million additive RGB colour range, continuously variable intensity output range
- > Lamp source SMT RGB 3w LED
- > Power requirement 24v DC

CODE & LENGTH	No LED's	POWER	LUMINOUS FLUX	NTP
LD71100 254mm	10	2.6w	19.3lm	£74.69
LD71400 1004mm	40	10w	76lm	£229.69



RGB LED STRIPS (LIGHT INWARD)

- > IP55 LED strip
- > 2 million additive RGB colour range,
continuously variable intensity output range
- > Stem \varnothing 18mm x 100mm
- > Power requirement DC 24v



RGB LED STRIPS (LIGHT OUTWARD)

- > IP55 LED strip
- > 2 million additive RGB colour range,
continuously variable intensity output range
- > Stem \varnothing 14mm x 100mm
- > Power requirement DC 24v
- > Can be used in closet for hanging clothes

CODE & LENGTH	No LED's	POWER	LUMINOUS FLUX	NTP
LD70110 374mm	14	5.1w	27lm	£135.80
LD70410 1124mm	44	13w	85lm	£298.75

CODE & LENGTH	No LED's	POWER	LUMINOUS FLUX	NTP
LD70120 354mm	14	5.1w	27lm	£149.99
LD70220 479mm	19	6.6w	36lm	£179.99
LD70320 804mm	32	9w	62lm	£229.99

POWER SUPPLY

- > 230v 50/60Hz power supply unit
- > Output DC 24v 2.5A 60w

LD98906 £39.90

CONTROLLER

- > Simple controller, 7 colour changing at 3 minute cycle
- > Input DC 12-24v

LD98900 £31.99

CONTROLLER

- > RGB IR constant colour changing controller
- > Input DC 12-24v
- > 60w max load

LD98904 £186.90

CAN BE INTERLINKED MAXIMUM 30 CM DISTANCE BETWEEN UNITS



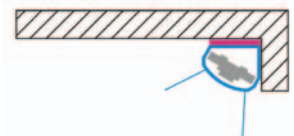

POWER SUPPLY/CONTROLLERS

- > 230v 50/60Hz power supply unit
- > Output DC 24v 2.5A 60w

LD98906 £39.90

- > Simple controller, cool/warm white mixer
- > Input DC 24v

LD98903 £52.99

- > Adapter from power supply to LED if not using controller

LD94110 £2.60

- > Flexible connector

LD94120 £1.08



LD94120
Flexible connector

MIXED WHITE LED STRIPS

- > Cool & warm white can be mixed by controller
- > Cool white 4000°K, mixed white 5000°K & warm white 6000°K
- > SMT cool white alternating with warm white
- > Power requirement 24v DC

CODE & LENGTH	No LED's	POWER	LUMINOUS FLUX	NTP
LD72100 250mm	24	2.9w	104lm	£44.99
LD72400 1000mm	96	11.6w	416lm	£156.20