

Estemo RGB

See the benefits:

Distinctive Design

Estemo RGBs are stylish circular modules which are available in a distinctive black or silver finish and come in a range of sizes incorporating 3 to 36 LEDs.

Improved safety

Estemo RGB modules run on a low voltage current making them safer and easier to work with.

UV and IR safe

The light from the Estemo RGB contains no UV or IR radiation, so it's safe for use on food and light-sensitive materials.

Maximum visual effect

Estemo RGB systems provide a much higher colour saturation and brilliance than filtering conventional light sources and enable creation of any colour in the spectrum.

Low maintenance costs

Estemo RGB is virtually maintenance free and offers long life up to 50,000 operating hours.

High reliability

Estemo RGB modules are extremely robust and resistant to vibrations.

Immediate start-up

Estemo RGB starts in an instant, even at temperatures as low as -20°C.

IP67 rated

All Estemo RGB modules are sealed to IP67 and so can be used in interior and exterior applications.



Imagine the Applications:

- Exterior architecture
- Interior architecture
- Spotlights
- Floodlights
- Accent lighting

Dimensions

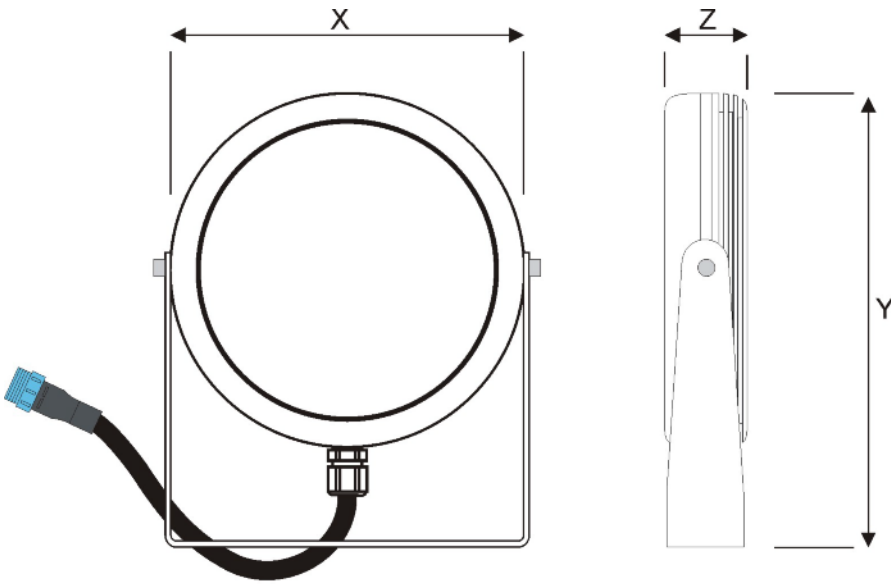

Estemo RGB Dimensions			
Options	X	Y	Z
Estemo 3	80	115	39
Estemo 6	100	160	39
Estemo 12	120	168	39
Estemo 36	189	230	44

Compatible Drivers

Ambient Temperature: -20° C to +40° C

Use a 350 mA constant current driver only

Model	Maximum number of Estemo RGBs connected					Supply Voltage	Dimensions
	3	6	9	12	36		
Colourdriver RF	6	3	2	1	X	85 – 265 V	179 x 53 x 32 mm
Colourdriver 36	12	6	4	3	1	95 – 265 V	310 x 55 x 45 mm

Compatible Drivers

Typical connection with 6up Estemo RGB units

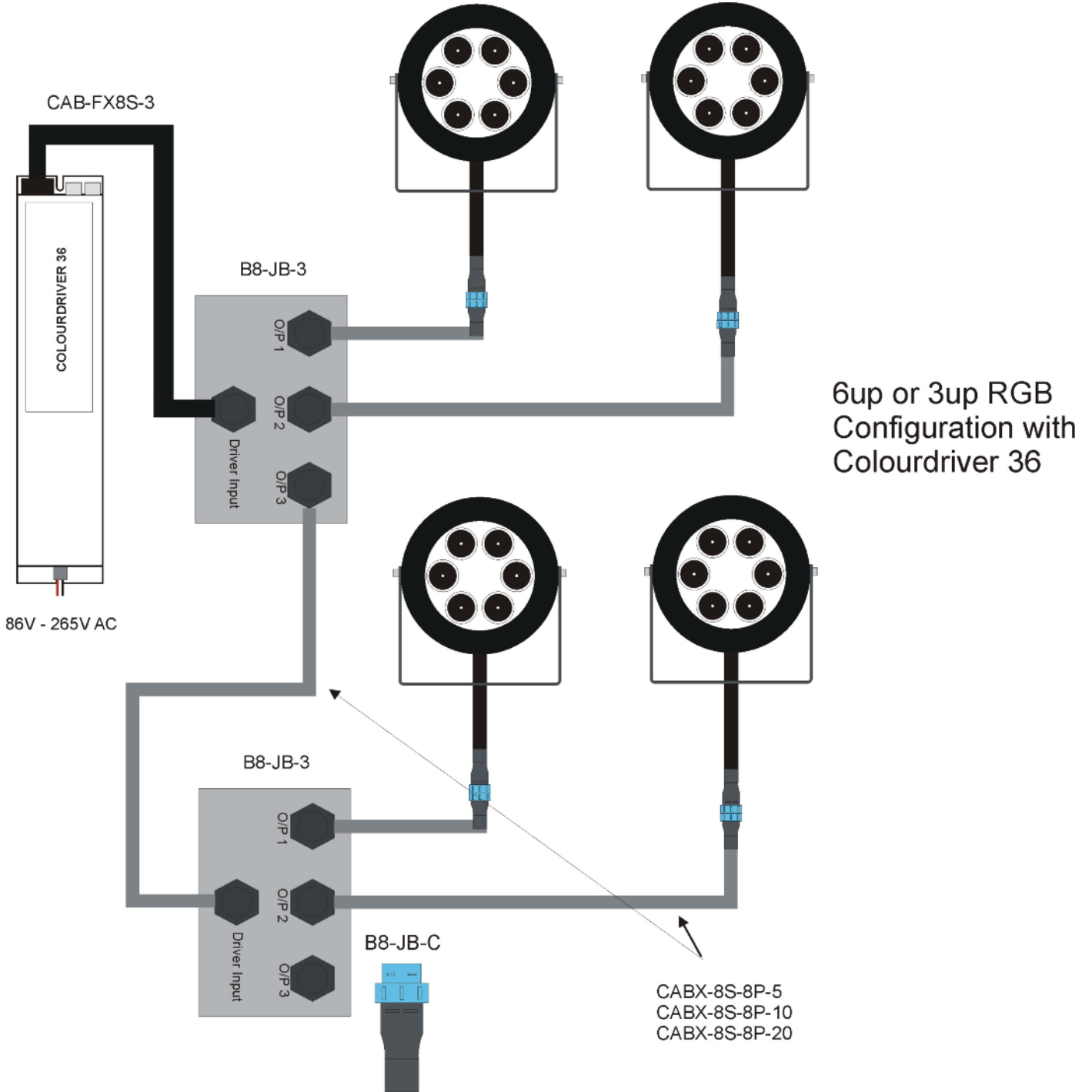

Compatible Drivers

Typical connection with 12up Estemo RGB units

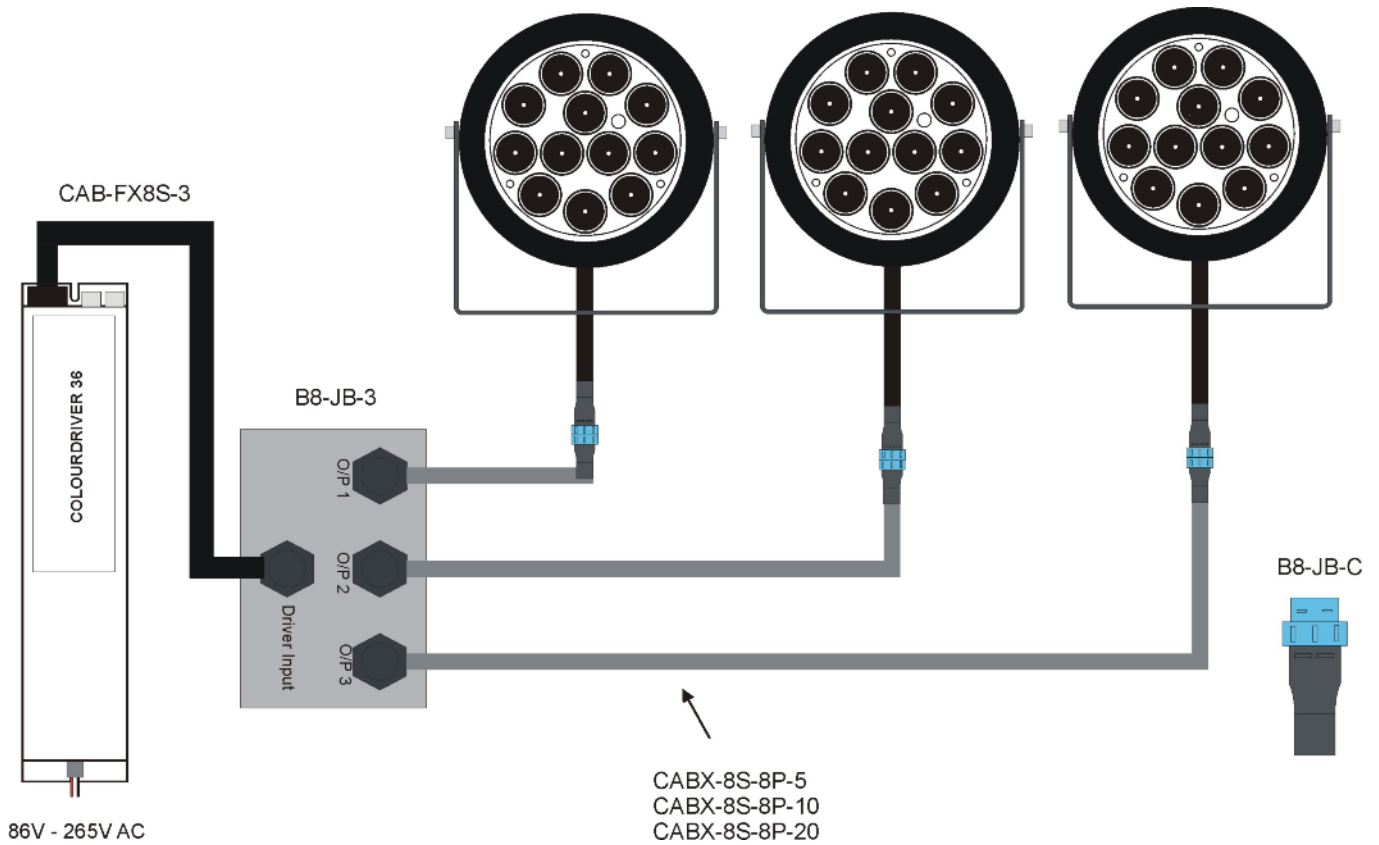

Compatible Drivers

Typical connection with 36up Estemo RGB unit

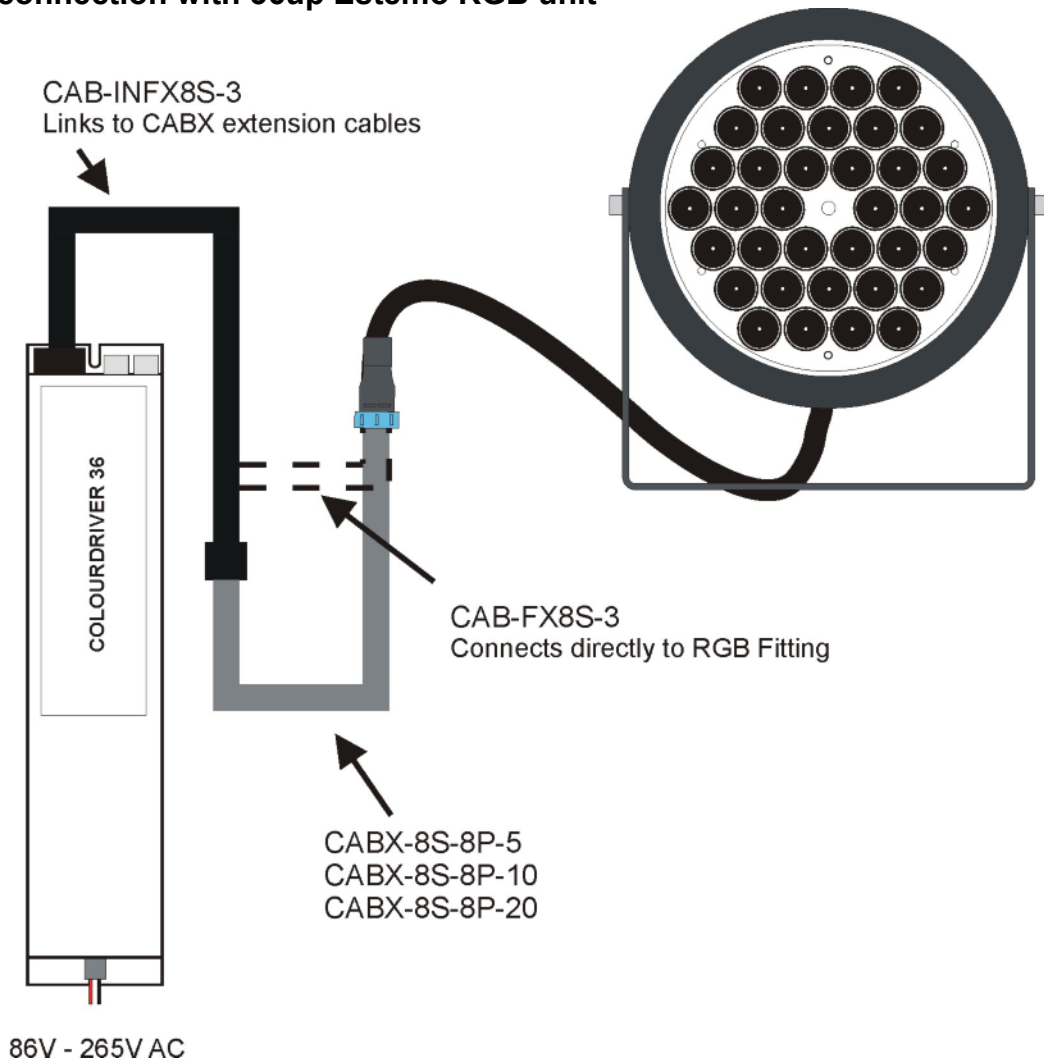



Accessories

Code	Description
CAB-FX8S-3	3 Metre Cable, links Colourdriver to Junction Block or LED Strip
CAB-INF8S-3	3 Metre Cable, links Colourdriver to Extension Cables (CABX)
CABX-8S-8P-5	5 Metre IP67 Extension Cable
CABX-8S-8P-10	10 Metre IP67 Extension Cable
CABX-8S-8P-20	20 Metre IP67 Extension Cable
B8-JB-3	IP67 Junction Block 1 In 3 Out
B8-JB-C	IP67 Junction Block Common Connector

Model Information

EST - X - X - RGB - XXXX

SPOT	Spot 5° optics
MED	Medium 15° optics
WIDE	Wide 25° optics
OVAL	Oval 5°x20° optics

Colour		Typical Light Output in Lumens/mW* for Estemo 12 up	
R	Red		420
G	Green		504
B	Blue		2112

Number of LEDs	Power Consumption (watts)	Typical Light Output (lumens)*		
		Red	Green	Blue
3	3.6	105	126	528
6	7.2	210	252	1056
9	10.8	315	378	1584
12	14.4	420	504	2112
36	43.2	1260	1512	6336

S Silver finish
B Black finish