

Lumoluce[®]
double your brightness

LED LIGHTING

2009 / 2010



CONTENS

| | |
|---|-------|
| Contens | 3 |
| Lumoluce series | |
| Introduction | 5 |
| Luzern plates | 6-14 |
| Luzern module | 14 |
| Lugano module | 15 |
| PIR module | 15 |
| Luxor module | 16 |
| Lublin module | 16 |
| Accessories for lugano / lublin / luxor | 17-18 |
| Luca module | |
| Luca adjustable | 19 |
| Luca fixed | 19 |
| Luxi module | |
| Luxi module | 20 |
| Lux module | 20 |
| Lugo module | 21 |
| Lugo accessories | 21 |
| Lucky led module | 22 |
| Lucky accessories | 22 |
| Luzern CM modules | 23 |
| Lumoluce accessories | 24 |
| | |
| Lumotrack system | |
| Lumotrack modules | 26 |
| Lumotrack accessories | 27 |
| | |
| Lumotech drivers | |
| Non dimmable drivers | 30-32 |
| Dimmable drivers | 33-35 |
| | |
| Technical sheets | |
| Connection schemes | 38 |
| Lumoluce Lux sheets | 39-40 |

LUMOluce SERIES

High quality LED Fixtures!

Excellent light output!

Energy saving!

Lifetime durability!

Contemporary design!



The LUMOluce series of LUMOtech is an innovative LED fixture concept.

The modular system consists of an aluminium baseplate, LED module (2,5W), driver and connection materials.

All series are available in seven different light colours. Including Cool white, Natural white and Warm white.

Due to their high efficiency and high quality optics, one powered of 2,5W generates the same output as a 20W MR16 12V halogen bulb, or as a 40W GU10, 230V halogen bulb.

Tests prove that you can save up to 30% compared to electricity-saving lamps and up to 85% compared to conventional halogen bulbs.

LUZERN PLATES

L05300R1.80



Luzern plate round 80mm
Clear anodised aluminium
Integrated system for ceiling mounting

Suitable for use with:
Luzern led module
Lugano led module
Luzern PIR module

L05300R1
Plate Luzern
Round 1 D 80mm
Colour: ALU

1 pce

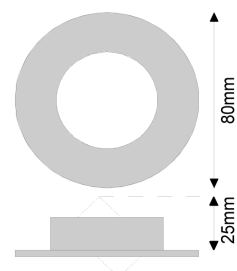

L05300R1.80 grey aluminium
L05300R1.80B black aluminium
L05300R1.80W white aluminium

L05300R1.100



Luzern plate round 100mm
Clear anodised aluminium
Integrated system for ceiling mounting

Suitable for use with:
Luzern led module
Lugano led module
Luzern PIR module

L05300R1.100
Plate Luzern
Round 1 D 100mm
Colour: ALU

1 pce

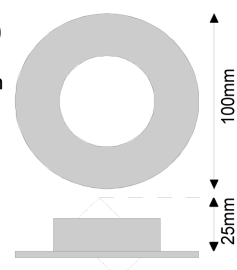

L05300R1.100 grey aluminium
L05300R1.100B black aluminium
L05300R1.100W white aluminium

L05300R1.120



Luzern plate round 120mm
Clear anodised aluminium
Integrated system for ceiling mounting

Suitable for use with:
Luzern led module
Lugano led module
Luzern PIR module

L05300R1.120

Plate Luzern
Round 1 D 120mm
Colour: **ALU**

1 pce

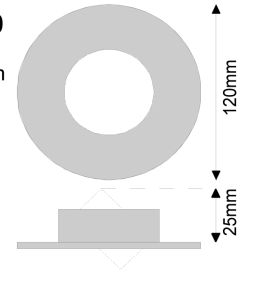

L05300R1.120 grey aluminium
L05300R1.120B black aluminium
L05300R1.120W white aluminium

L05300R3.120



Luzern plate round 120mm
Clear anodised aluminium
Integrated system for ceiling mounting

Suitable for use with:
Luzern led module
Lugano led module
Luzern PIR module

L05300R3

Plate Luzern
Round 3 D 120mm
Colour: **ALU**

1 pce

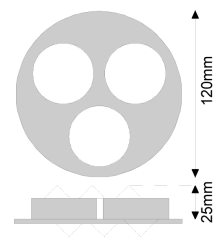

L05300R3.120 grey aluminium
L05300R3.120B black aluminium
L05300R3.120W white aluminium

L05300R3.200

Luzern plate round 200mm
Clear anodised aluminium
Integrated system for ceiling mounting

Suitable for use with:
Luzern led module
Lugano led module
Luzern PIR module



L05300R3
Plate Luzern
Round 3 D 200mm
Colour: ALU

1 pce

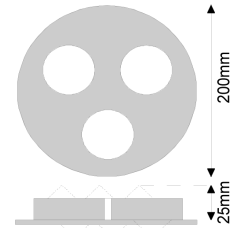

L05300R3.200 grey aluminium

L05300R4.140

Luzern plate round 140mm
Clear anodised aluminium
Integrated system for ceiling mounting

Suitable for use with:
Luzern led module
Lugano led module
Luzern PIR module



L05300R4
Plate Luzern
Round 4 D 140mm
Colour: ALU

1 pce

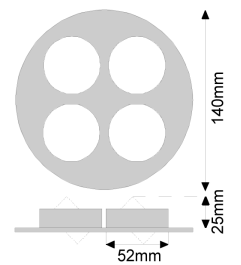

L05300R4.140 grey aluminium

L05300R5.150



Luzern plate round 150mm
Clear anodised aluminium
Integrated system for ceiling mounting

Suitable for use with:
Luzern led module
Lugano led module
Luzern PIR module

L05300R5
Plate Luzern
Round 5 D 150mm
Colour: ALU

1 pce

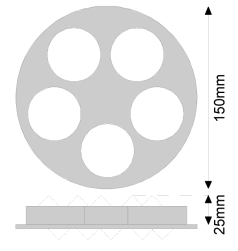

L05300R5.150 grey aluminium

L05300R5.200



Luzern plate round 200mm
Clear anodised aluminium
Integrated system for ceiling mounting

Suitable for use with:
Luzern led module
Lugano led module
Luzern PIR module

L05300R5.200
Plate Luzern
Round 5 D 200mm
Colour: ALU

1 pce

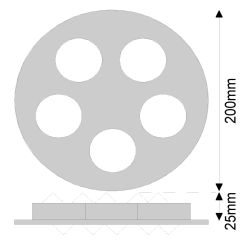

L05300R5.200 grey aluminium
L05300R5.200B black aluminium
L05300R5.200W white aluminium

L05300R5.260



Luzern plate round 260mm
Clear anodised aluminium
Integrated system for ceiling mounting

Suitable for use with:
Luzern led module
Lugano led module
Luzern PIR module

L05300R5.260

Plate Luzern
Round 5 D 260mm
Colour: ALU

1 pce

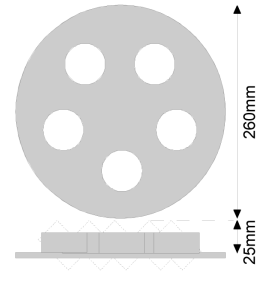

L05300R5.260 grey aluminium
L05300R5.260B black aluminium
L05300R5.260W white aluminium

L05300R7.260



Luzern plate round 260mm
Clear anodised aluminium
Integrated system for ceiling mounting

Suitable for use with:
Luzern led module
Lugano led module
Luzern PIR module

L05300R7.260

Plate Luzern
Round 7 D 260mm
Colour: ALU

1 pce

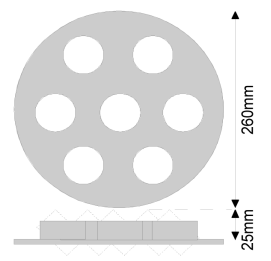

L05300R7.260 grey aluminium
L05300R7.260B black aluminium
L05300R7.260W white aluminium

L05300OV2



Luzern plate oval 142x80mm
Clear anodised aluminium
Integrated system for ceiling mounting

Suitable for use with:
Luzern led module
Lugano led module
Luzern PIR module

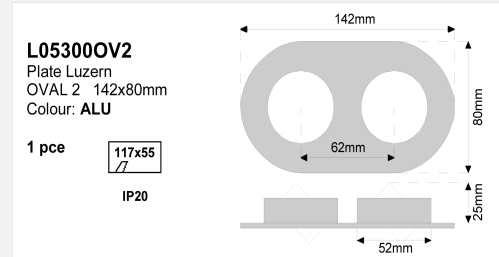

L05300OV2 grey aluminium
L05300OV2B black aluminium
L05300OV2W white aluminium

L05300S1.80



Luzern plate square 80x80mm
Clear anodised aluminium
Integrated system for ceiling mounting

Suitable for use with:
Luzern led module
Lugano led module
Luzern PIR module

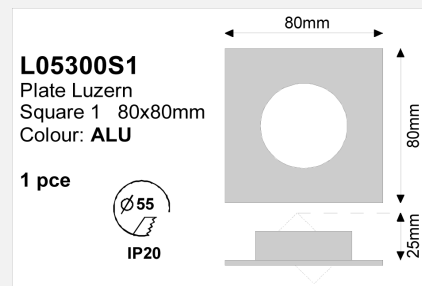

L05300S1.80 grey aluminium
L05300S1.80B black aluminium
L05300S1.80W white aluminium

L05300S4



Luzern plate square 142x142mm
Clear anodised aluminium
Integrated system for ceiling mounting

Suitable for use with:
Luzern led module
Lugano led module
Luzern PIR module

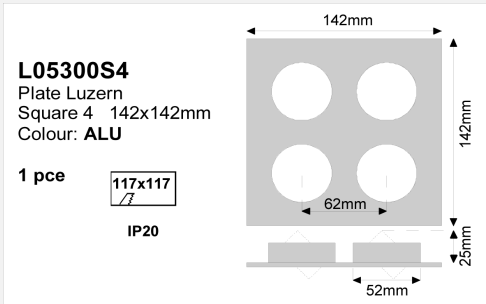

L05300S4 grey aluminium

L05300RT2



Luzern plate rectangular 142X80mm
Clear anodised aluminium
Integrated system for ceiling mounting

Suitable for use with:
Luzern led module
Lugano led module
Luzern PIR module

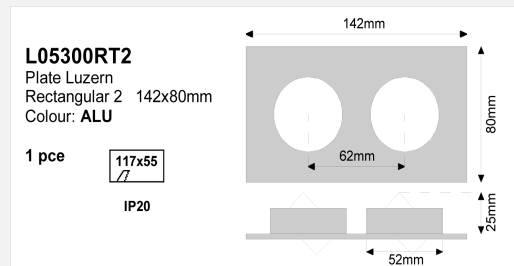

L05300RT2 grey aluminium
L05300RT2B black aluminium
L05300RT2W white aluminium

L05300RT3



Luzern plate rectangular 204x80mm
Clear anodised aluminium
Integrated system for ceiling mounting

Suitable for use with:
Luzern led module
Lugano led module
Luzern PIR module

L05300RT3
Plate Luzern
Rectangular 3 204x80mm
Colour: ALU

1 pce

180x55

IP20

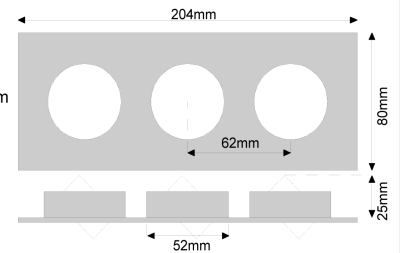

L05300RT3 grey aluminium
L05300RT3B black aluminium
L05300RT3W white aluminium

L05300RT4



Luzern plate square 266X80mm
Clear anodised aluminium
Integrated system for ceiling mounting

Suitable for use with:
Luzern led module
Lugano led module
Luzern PIR module

L05300RT4
Plate Luzern
Rectangular 4 266x80mm
Colour: ALU

1 pce

241x55

IP20

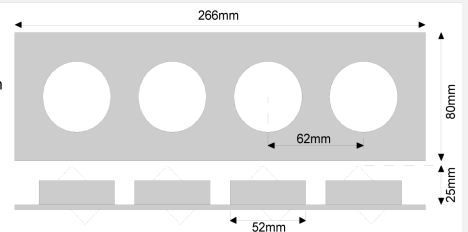

L05300RT4 grey aluminium

L05300RT5

Luzern plate rectangular 328x80mm
Clear anodised aluminium
Integrated system for ceiling mounting

Suitable for use with:

Luzern led module
Lugano led module
Luzern PIR module

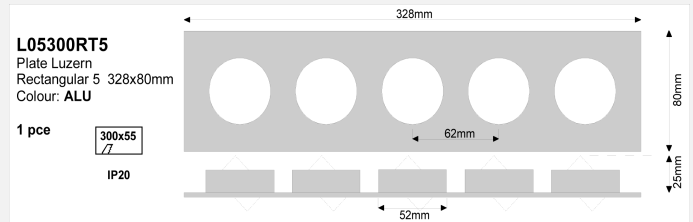

L05300RT5 grey aluminium

LUZERN MODULE

L05400

Luzern 2,5W / 700mA led module
Available in seven different colours
Adjustable spot with standard 40° lens.
Clear anodised aluminium

Suitable for use with:

Luzern plates
All lumotech led drivers (NS-types are especially suited)



L05400WW (warm white / 125Lm)
L05400NW (natural white / 150Lm)
L05400CW (cool white / 190Lm)
L05400R (red / 60Lm)
L05400A (amber / 70Lm)
L05400G (green / 90Lm)
L05400B (blue / 16Lm)

L05400xx Grey aluminium
L05400xxB Black aluminium
L05400xxW White aluminium

LUGANO MODULE

L05410



Lugano 2,5W / 700mA led module

Available in seven different colours
Spot with 120° lightangle.
Clear anodised aluminium

Suitable for use with:

Luzern plates / triangle element / ground housing
Shower housing / stand alone spot.

All lumotech led drivers (NS-types are especially suited)

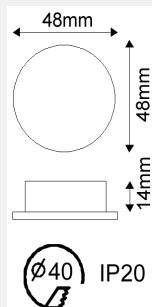

L05410WW (warm white / 125Lm)
L05410NW (natural white / 150Lm)
L05410CW (cool white / 190Lm)
L05410R (red / 60Lm)
L05410A (amber / 70Lm)
L05410G (green / 90Lm)
L05410B (blue / 16Lm)

L05410xx Grey aluminium

PIR MODULE

L05405



Luzern PIR module

Passive infrared luzern module
50-1000lux
10sec – 30min

Suitable for use with:

Luzern plates
All lumotech led drivers (NS-types are especially suited)

L05405xx Grey aluminium
L05405xxB Black aluminium
L05405xxW White aluminium

LUXOR MODULE

L05420



Luxor 2,5W / 700mA led module

Available in seven different colours
Adjustable spot with standard 40° lens.
Clear anodised aluminium

Suitable for use with:

Ground housing / Shower housing / Stand alone spot
Compatible GU10 and MR16 fixtures.
All lumotech led drivers (NS-types are especially suited)

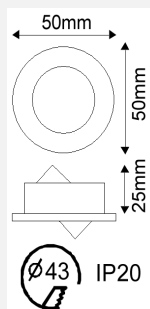

L05420WW (warm white / 125Lm)
L05420NW (natural white / 150Lm)
L05420CW (cool white / 190Lm)
L05420R (red / 60Lm)
L05420A (amber / 70Lm)
L05420G (green / 90Lm)
L05420B (blue / 16Lm)

L05420xx grey aluminium
L05420xxB black aluminium
L05420xxW white aluminium

LUBLIN MODULE

L05480



Lublin 7,5W / 700mA Led module

Clear anodised aluminium
Integrated system for mounting.
Integrated cooling element.
35° light beam angle.

Suitable for use with:

Shower housing / Ground spot
Compatible GU10 and MR16 fixtures

L05480WW (warm white / 375Lm)
L05480NW (natural white / 450Lm)
L05480CW (cool white / 570Lm)

L05480xx grey aluminium

ACCESSORIES FOR LUGANO / LUXOR / LUBLIN

L05453TR1

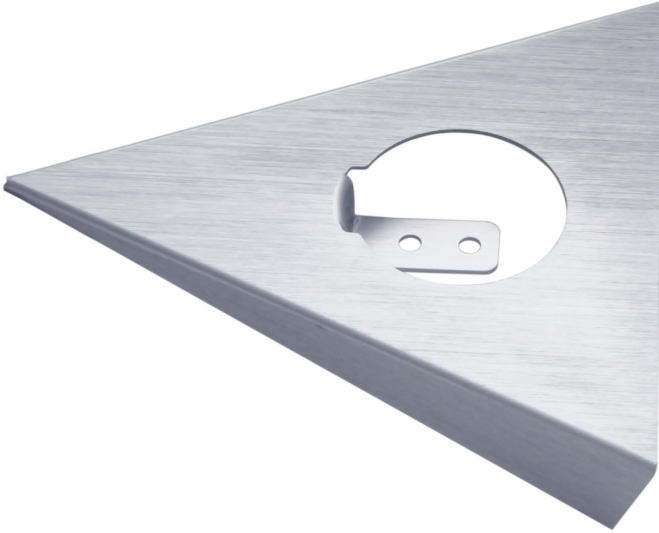

Lugano plate triangular 130x130mm

Clear anodised aluminium
Integrated system for mounting.
Suitable for kitchen appliances.

Suitable for use with:
Lugano module

L05453TR1

Plate Lugano
Triangle 1 130x130mm
Colour: ALU

1 pce IP20

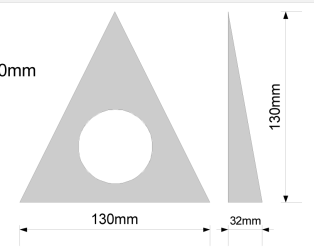

L05453TR1 grey aluminium

L05485



Shower housing IP44

Stainless steel fixture.
IP44 rated.

Suitable for use with:
Lugano module / Luxor module / Lublin module

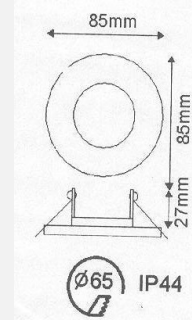

L05485 Stainless steel

L05486



Ground housing IP67
Stainless steel housing
Toughend glass

Suitable for use with:
Luxor led module
Lugano led module
Lublin led module

Height: 140mm
Width: 105mm
Ground hole width: 90mm
Ground hole depth: 140mm

L05486 Stainless steel

L05320



Lublin banana fixture
Clear anodised aluminium
90°/360° adjustable lublin fixture.

Suitable for use with:
Lublin led module

Width: 110mm
Ceiling hole size: 100mm
Ceiling hole depth: 70mm

L05320G grey aluminium
L05320B black aluminium
L05320W white aluminium

LUCA MODULES

L05451

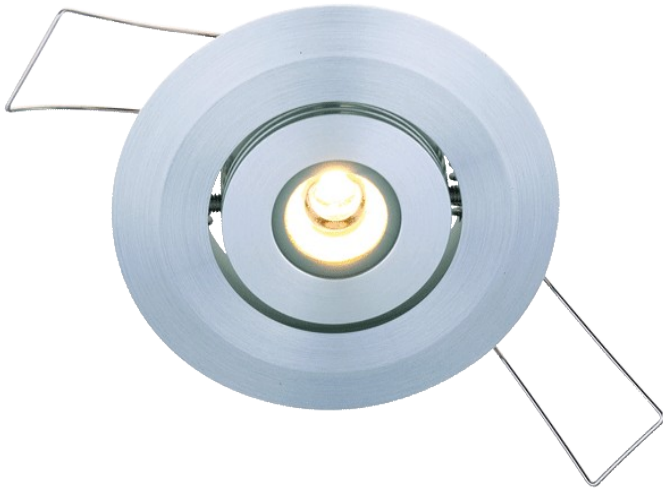

Luca adjustable 2,5W / 700mA led module
Available in three different colours
Adjustable spot with standard 40° lens.
Clear anodised aluminium / Stainless steel

Suitable for use with:
Only to use as a stand alone spot.
All lumotech led drivers (NS-types are especially suited)

L05451WW (warm white / 125Lm)
L05451NW (natural white / 150Lm)
L05451CW (cool white / 190Lm)

Sizes: 62x25mm
Ceiling hole size: 52mm

L05451xx Stainless steel

L05452

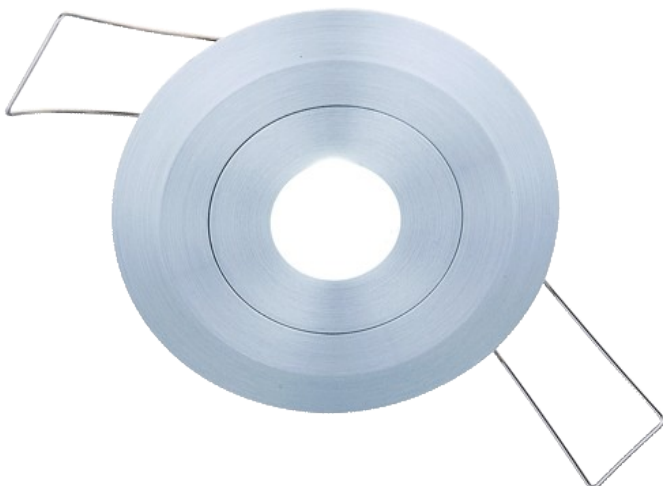

Luca fixed 2,5W / 700mA led module
Available in three different colours
Fixed spot with standard 40° lens.
Clear anodised aluminium / Stainless steel

Suitable for use with:
Only to use as a stand alone spot.
All lumotech led drivers (NS-types are especially suited)

L05452WW (warm white / 125Lm)
L05452NW (natural white / 150Lm)
L05452CW (cool white / 190Lm)

Sizes: 62x25mm
Ceiling hole size: 52mm

L05452xx Stainless steel

LUXI MODULES

L05430



Luxi 2,5W / 700mA led module
 Available in seven different colours
 Spot on a bracket with standard 40° lens.
 Clear anodised aluminium
 100mm decorative wire sleeve attached

Suitable for use with:
 Only to use as a stand alone spot.
 All lumotech led drivers (NS-types are especially suited)

L05430WW (warm white / 125Lm)
 L05430NW (natural white / 150Lm)
 L05430CW (cool white / 190Lm)
 L05430R (red / 60Lm)
 L05430A (amber / 70Lm)
 L05430G (green / 90Lm)
 L05430B (blue / 16Lm)

Sizes: 40x35x25mm

L05430xx grey aluminium
 L05430xxB black aluminium
 L05430xxW white aluminium

L05431



Lux 2,5W / 700mA led module
 Available in seven different colours
 Spot on whitout bracket with standard 40° lens.
 Clear anodised aluminium
 100mm decorative wite sleeve attached

Suitable for use with:
 Only to use as a stand alone spot.
 All lumotech led drivers (NS-types are especially suited)

L05431WW (warm white / 125Lm)
 L05431NW (natural white / 150Lm)
 L05431CW (cool white / 190Lm)
 L05431R (red / 60Lm)
 L05431A (amber / 70Lm)
 L05431G (green / 90Lm)
 L05431B (blue / 16Lm)

Sizes: 35x25mm

L05431xx grey aluminium
 L05431xxB black aluminium
 L05431xxW white aluminium

LUGO MODULE

L05310



Lugo 2,5W / 700mA led module

Available in seven different colours

Fixed up or downlighter..

Dark grey aluminium housing.

Suitable for use with:

Lugo stucco kit.

All lumotech led drivers (NS-types are especially suited)

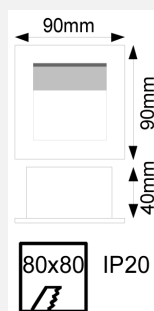

L05310WW (warm white / 125Lm)

L05310NW (natural white / 150Lm)

L05310CW (cool white / 190Lm)

L05310R (red / 60Lm)

L05310A (amber / 70Lm)

L05310G (green / 90Lm)

L05310B (blue / 16Lm)

L05310xx grey aluminium

ACCESSORIES FOR THE LUGO MODULE

L05280

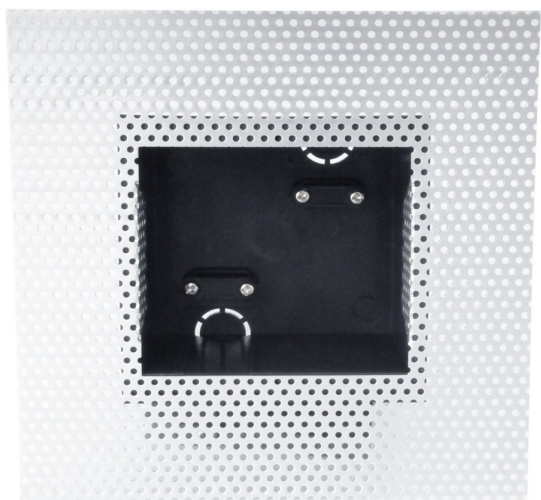

Lugo stucco kit.

Plastic mounting box
with aluminium stucco plate.

Suitable for use with:

Lugo Led module.

L05280 grey aluminium / black plastic

LUCKY MODULE

L05316



Lucky 2,5W / 700mA led module

Available in seven different colours

Spot with 120° lightangle.

Clear anodised aluminium..

Suitable for use with:

Lucky spacer

Stand alone spot.

All lumotech led drivers (NS-types are especially suited)

L05316WW (warm white / 125Lm)

L05316NW (natural white / 150Lm)

L05316CW (cool white / 190Lm)

L05316R (red / 60Lm)

L05316A (amber / 70Lm)

L05316G (green / 90Lm)

L05316B (blue / 16Lm)

Sizes: 62x25mm

Ceiling hole size: 55mm

L05316xx grey aluminium

ACCESSORIES FOR THE LUCKY MODULE

935018



Lucky spacer kit.

Aluminium spacer for the lucky led module

Mounting screws included

Suitable for use with:

Lucky led module.

935018 grey aluminium

LUZERN CM MODULES

L05301



Luzern CM 10W / 700mA led module

Available in two different colours
Ceiling mountable led housing
Four adjustable led spots with a 40° lens.
Mains dimmable driver included (L05021)
100mm mains cable included
Ceiling clamping system included.

Suitable for use with:

Only to use as a stand alone spot.

L05301S4

Plate Luzern CM
Square 4 190x140mm
Colour: ALU

1 pce IP20

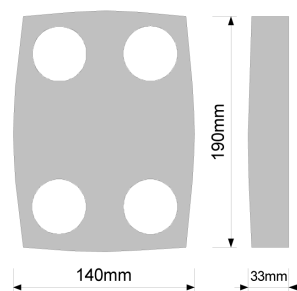

L05301WW grey aluminium / warm white light
L05301NW grey aluminium / natural white light

L05302



Luzern CM 7,5W / 700mA led module

Available in two different colours
Ceiling mountable led housing
Three adjustable led spots with a 40° lens.
Mains dimmable driver included (L05021)
100mm mains cable included
Ceiling clamping system included.

Suitable for use with:

Only to use as a stand alone spot.

L05301T3G

Plate Luzern CM
Triangle 3 216x205mm
Colour: GREY

1 pce IP20

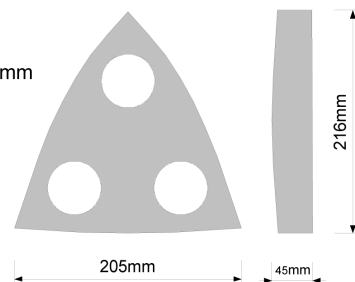

L05302WW grey aluminium / warm white light
L05302NW grey aluminium / natural white light

LUMOLUCE ACCESSORIES

L05484



Lumoluce lenses

7° pinpoint lens

15° lens

60° reflector cap

Suitable for use with:

Luzern, Luxor, Luca, Luxi, Luzern CM

931945 clear lens (7°)

931043 clear lens (15°)

931048 white reflector cap (60°)

L05202 / L05211



Lumoluce click and go wiring.

Lumoluce wiring for use with NS drivers.

All modules are fitted with a click and go connector.

Suitable for use with:

All Lumoluce led modules.

All Lumotech NS drivers

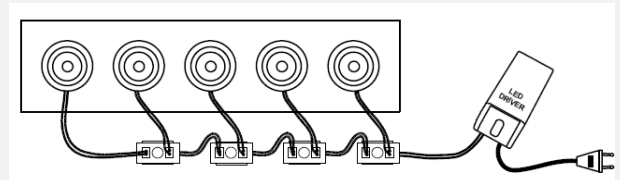

L05202 2m wire 2 plugs

L05211 1m wire 4 plugs

LUMOtrack SERIES

High quality LED Fixtures!

Excellent light output!

Energy saving!

Lifetime durability!

Contemporary design!



The LUMOtrack series of LUMOtech is an innovative LED track concept.

The track module system consists of a light module with built-in driver and a three-phase 230Vac rail adapter.

The modules are available in three different light colors. These colors are cool white, natural white and warm white. Also, the fixture color can be chosen. A grey, white or black color is available.

These LED track systems generate an output similar to the halogen systems, only with a much lower energy consumption.

The 18W system can generate an output up to 1330Lm with a lux value of almost 5000 at one meter.

The 10W system can generate an output up to 760Lm with a lux value of almost 3000 at one meter.

Tests prove that you can save up to 30% compared to electricity-saving systems and up to 90% compared to conventional halogen rail systems.

LUMOTRACK MODULES

L05482



Lumotrack TR4 led spot 10W

4x2,5W 700mA

35° beam angle

Available in three different colours

Threephase adapter included.

Driver included in housing.

Direct 230Vac input.

Suitable for use with:

Compatible threephase 230Vac rail systems.

L05482WW (warm white / 500Lm)

L05482NW (natural white / 600Lm)

L05482CW (cool white / 760Lm)

Sizes: 130x75x160mm

L05482xxG grey aluminium

L05482xxB black aluminium

L05482xxW white aluminium

L05484



Lumotrack TR7 led spot 18W

7x2,5W 700mA

35° beam angle

Available in three different colours

Threephase adapter included.

Driver included in housing.

Direct 230Vac input.

Suitable for use with:

Compatible threephase 230Vac rail systems.

L05484WW (warm white / 875Lm)

L05484NW (natural white / 1050Lm)

L05484CW (cool white / 1330Lm)

Sizes: 180x120x220mm

L05484xxG grey aluminium

L05484xxB black aluminium

L05484xxW white aluminium

LUMOTRACK ACCESSORIES

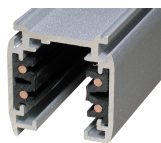

Lumotrack 3fase rail 230Vac

L05493-1 (1 meter rail)
L05493-2 (2 meter rail)
L05493-3 (3 meter rail)



Lumotrack Live end connector

L05494L (65mm left)
L05494R (65mm right)

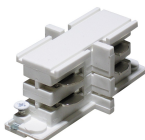

Lumotrack mini joiner

L05495



Lumotrack straight connector

L05496 (40mm straight)



Lumotrack L joint connector

L05497L (65x65mm left)
L05497R (65x65mm right)



Lumotrack T joint connector

L05498L (65x95mm left)
L05498R (65x95mm right)



Lumotrack X joint connector

L05499 (95x95mm X joint)



Lumotrack flexible connector

L05500 (160mm)



Lumotrack End cap

L05501



Lumotrack lamp adapter 3fase

L05505

Is included in L05482/L05484 package

L05xxxxG grey aluminium
L05xxxxB black aluminium
L05xxxxW white aluminium

LUMOtech DRIVERS

High quality LED Drivers!
Excellent efficiency!
Four safety systems!
Lifetime durability!
Compact design!



The LUMOtech drivers are an high quality range of multifunctional led drivers.

The drivers can generate several different currents and voltages depending on the type of driver.

Lumotech drivers are an high quality range of led drivers with an extraordinary efficiency.
Input voltages can be from 110Vac up to 240Vac or from 12Vdc up to 32V dc.
Outputs can be a constant current between 250mA and 1400mA or voltages between 4Vdc and 24Vdc.
Also the way of dimming can be different. So are 0-10V, fase dimming and pulse systems possible.

Tests prove that using a lumotech driver can extend the lifespan of your led lighting sufficiently. Also the efficiency of the whole installation can be improved by using this drivers.

LUMOTECH NON DIMMABLE

L05020



Lumotech 12,5W non dimmable led driver

OUTPUT:

12,5W 700mA (1-4 lumoluce led's @ 2,5W)
 12,5W 350mA (1-9 lumoluce led's @ 1,2W)

INPUT:

110-240Vac 50/60Hz

PROTECTION:

Thermal / Short Circuit / Over Voltage / Open circuit

SUITABLE FOR USE WITH:

All Led modules @ 350mA or 700mA

APPROVALS:

ENEC / KEMA / CE

DIMENSIONS / WEIGHT:

99x39x23,5mm / 70g

DIM FUNCTIONS:

Manual switch wiring (350mA / 700mA)

L05020 led driver
 L05020NS led driver wiring included

L05010



Lumotech 20W non dimmable led driver

OUTPUT:

20W 700mA (1-6 lumoluce led's @ 2,5W)
 20W 350mA (1-14 lumoluce led's @ 1,2W)
 24V (20W) / 12V (15W) / 10V (12W)
 8V (10W) / 6V (7W) / 5V (6W) / 4V (5W)

INPUT:

110-240Vac 50/60Hz

PROTECTION:

Thermal / Short Circuit / Over Voltage / Open circuit

SUITABLE FOR USE WITH:

All led modules at compatible voltage or current.

APPROVALS:

ENEC / KEMA / CE

DIMENSIONS / WEIGHT:

110x52x24mm / 105g

DIM FUNCTIONS:

Manual dipswitch setting

L05010 led driver
 L05010NS led driver wiring included

L05044



Lumotech 40W non dimmable led driver

OUTPUT:

40W 700mA (1-12 lumoluce led's @ 2,5W)
40W 350mA (1-25 lumoluce led's @ 1,2W)
All other currents between 300mA and 1400mA

INPUT:

110-240Vac 50/60Hz

PROTECTION:

Thermal / Short Circuit / Over Voltage / Open circuit

SUITABLE FOR USE WITH:

All Led modules with a drive current between
300mA and 1400mA

APPROVALS:

ENEC / KEMA / CE

DIMENSIONS / WEIGHT:

156x42x32mm / 160g

DIM FUNCTIONS:

Manual switch wiring (300mA - 1400mA)

L05044 led driver
L05044NS led driver wiring included

L05030



Lumotech 20W non dimmable led driver

OUTPUT:

20W 700mA (1-6 lumoluce led's @ 2,5W)
20W 350mA (1-14 lumoluce led's @ 1,2W)
24V (20W) / 12V (15W) / 10V (12W)
8V (10W) / 6V (7W) / 5V (6W) / 4V (5W)

INPUT:

24-32Vdc

PROTECTION:

Thermal / Short Circuit / Over Voltage / Open circuit

SUITABLE FOR USE WITH:

All Led modules at compatible voltage or currents

APPROVALS:

ENEC / KEMA / CE

DIMENSIONS / WEIGHT:

110x52x24mm / 105g

DIM FUNCTIONS:

Manual dipswitch setting

L05030 led driver

L05024



Lumotech 5W dimmable led driver

OUTPUT:

5W 350mA (1-4 lumoluce led's @ 1,2W)

INPUT:

110-240Vac 50/60Hz

PROTECTION:

Thermal

SUITABLE FOR USE WITH:

All Led modules with a drive current of 350mA

APPROVALS:

KEMA / CE

DIMENSIONS / WEIGHT:

99x39x23,5mm / 70g

DIM FUNCTIONS:

One drive current 350mA

L05024 led driver

L05024NS led driver wiring included

LUMOTECH DIMMABLE

L05021



Lumotech 12,5W non dimmable led driver

OUTPUT:

12,5W 700mA (1-4 lumoluce led's @ 2,5W)
 12,5W 350mA (1-9 lumoluce led's @ 1,2W)

INPUT:

110-240Vac 50/60Hz

PROTECTION:

Thermal / Short Circuit / Over Voltage / Open circuit

SUITABLE FOR USE WITH:

All Led modules @ 350mA or 700mA

APPROVALS:

ENEC / KEMA / CE

DIMENSIONS / WEIGHT:

99x39x23,5mm / 70g

DIM FUNCTIONS:

Manual switch wiring (350mA / 700mA)
 Mains fase dimmable

L05021 led driver
 L05021NS led driver wiring included

L05011



Lumotech 20W non dimmable led driver

OUTPUT:

20W 700mA (1-6 lumoluce led's @ 2,5W)
 20W 350mA (1-14 lumoluce led's @ 1,2W)
 1050mA (20W) / 24V (20W)
 12V (12W) / 10V (10W)

INPUT:

110-240Vac 50/60Hz

PROTECTION:

Thermal / Short Circuit / Over Voltage / Open circuit

SUITABLE FOR USE WITH:

All Led modules compatible voltages or currents

APPROVALS:

ENEC / KEMA / CE

DIMENSIONS / WEIGHT:

110x52x24mm / 105g

DIM FUNCTIONS:

Manual dipswitch setting
 0-10V lighting control
 Push button

L05011 led driver
 L05011NS led driver wiring included

L05015



Lumotech 20W dimmable led driver

OUTPUT:

20W 2x350mA (1-14 lumoluce led's @ 1,2W)

INPUT:

110-240Vac 50/60Hz

PROTECTION:

Thermal / Short Circuit / Over Voltage / Open circuit

SUITABLE FOR USE WITH:

All Led modules with a drive current of 350mA

APPROVALS:

ENEC / KEMA / CE

DIMENSIONS / WEIGHT:

110x52x24mm / 105g

DIM FUNCTIONS:

One drive current 350mA
0-10V 100K Lighting control

L05015 led driver

L05015NS led driver wiring included

L05016



Lumotech 20W non dimmable led driver

OUTPUT:

20W 700mA (1-6 lumoluce led's @ 2,5W)

20W 350mA (1-14 lumoluce led's @ 1,2W)

20W 250mA – 1000mA

INPUT:

110-230Vac 50/60Hz

PROTECTION:

Thermal / Short Circuit / Over Voltage / Open circuit

SUITABLE FOR USE WITH:

All Led modules at compatible currents

APPROVALS:

ENEC / KEMA / CE

DIMENSIONS / WEIGHT:

110x52x24mm / 105g

DIM FUNCTIONS:

0-10V 100K Lighting control
Push Button
Manual current control

L05016 led driver

L05016 led driver wiring included

L05035



Lumotech 20W dimmable led driver

OUTPUT:

20W 2x350mA (1-14 lumoluce led's @ 1,2W)

INPUT:

24-32Vdc

PROTECTION:

Thermal / Short Circuit / Over Voltage / Open circuit

SUITABLE FOR USE WITH:

All Led modules with a drive current of 350mA

APPROVALS:

ENEC / KEMA / CE

DIMENSIONS / WEIGHT:

110x42x24mm / 105g

DIM FUNCTIONS:

One drive current 350mA
0-10V 100K lighting control

L05035 led driver

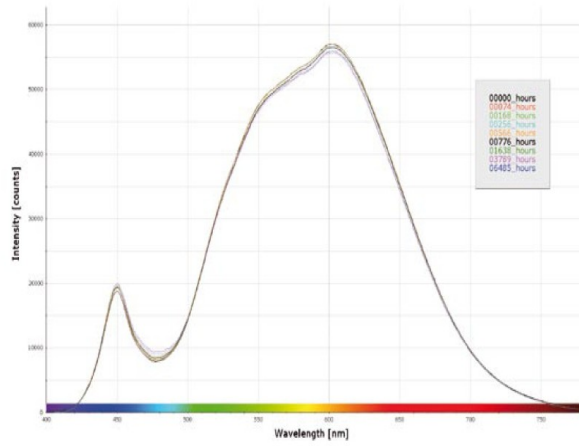

TECHNICAL SHEETS

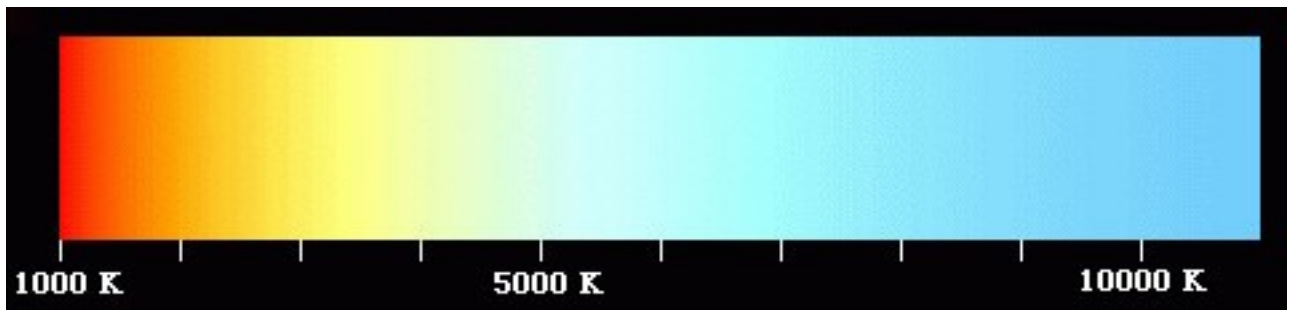

Connection scheme for Lumoluce LED lighting

Always disconnect the mains of the driver before plugging or unplugging the LEDs.

Failure to do so will damage or destroy the LEDs because of the high voltage present on the driver output when there is no load connected.

L053000S1

Short Circuit Plug:

The LEDs are always connected in series, so you will need to close the circuit with an extra plug when you connect only one LED.

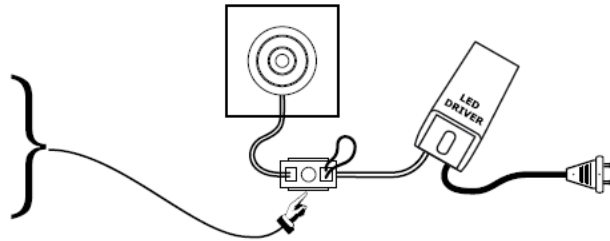

L053000RT2

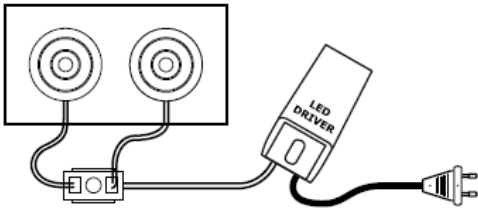

L053000RT3

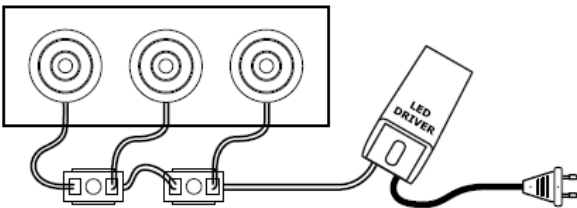

L053000RT4

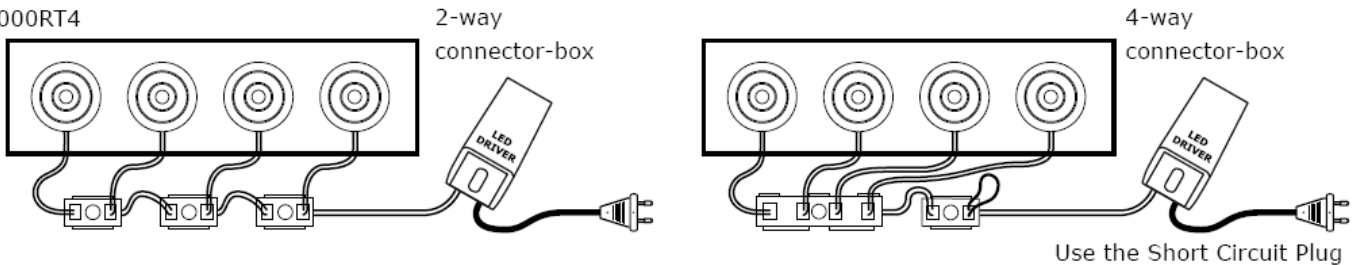

L053000RT5

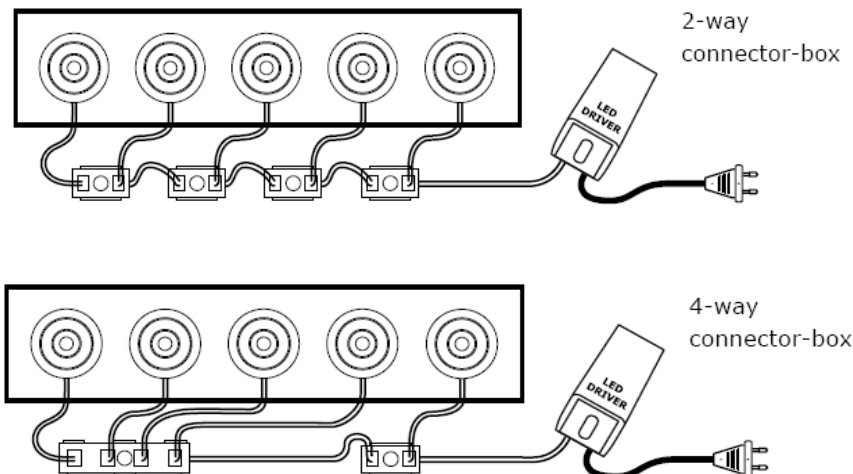

Lumoluce Lux sheets

2,5W Luzern, Luxor, Luxi, Luca

| 60° reflector | | | |
|----------------------|----------|----------|----------|
| | Lux / 1m | Lux / 2m | Lux / 3m |
| WW | 100 | 25 | 11 |
| NW | 120 | 30 | 13 |
| CW | 155 | 38 | 17 |
| Beam diam. | 1,15m | 2,25m | 3,40m |
| 40° lens | | | |
| | Lux / 1m | Lux / 2m | Lux / 3m |
| WW | 350 | 90 | 40 |
| NW | 450 | 112 | 50 |
| CW | 660 | 165 | 75 |
| Beam diam. | 0,70m | 1,40m | 2,10m |
| 15° lens | | | |
| | Lux / 1m | Lux / 2m | Lux / 3m |
| WW | 1100 | 275 | 122 |
| NW | 1400 | 350 | 155 |
| CW | 2000 | 500 | 225 |
| Beam diam. | 0,25m | 0,50m | 0,75m |
| 7° lens | | | |
| | Lux / 1m | Lux / 2m | Lux / 3m |
| WW | 2200 | 550 | 245 |
| NW | 2830 | 700 | 315 |
| CW | 4150 | 1040 | 460 |
| Beam diam. | 0,13m | 0,25m | 0,38m |

2,5W Lugano, Lucky

| 120° angle | | | |
|-------------------|------------|----------|--|
| | Lux / 0,5m | Lux / 1m | |
| WW | 200 | 50 | |
| NW | 240 | 60 | |
| CW | 300 | 75 | |
| Beam diam. | 0,50m | 2,10m | |

Lumoluce Lux sheets

7,5W Lublin

| 35°lens | | | |
|----------------|----------|----------|----------|
| | Lux / 1m | Lux / 2m | Lux / 3m |
| WW | 1050 | 260 | 115 |
| NW | 1300 | 325 | 145 |
| CW | 1800 | 470 | 210 |
| Beam diam. | 0,63m | 1,25m | 1,90m |

10W Lumotrack TR4

| 35° lens | | | |
|-----------------|----------|----------|----------|
| | Lux / 1m | Lux / 2m | Lux / 3m |
| WW | 1400 | 350 | 155 |
| NW | 1800 | 450 | 200 |
| CW | 2600 | 660 | 300 |
| Beam diam. | 0,63m | 1,25m | 1,90m |

18W Lumotrack TR7

| 35° lens | | | |
|-----------------|----------|----------|----------|
| | Lux / 1m | Lux / 2m | Lux / 3m |
| WW | 2500 | 625 | 275 |
| NW | 3200 | 800 | 355 |
| CW | 4700 | 1180 | 520 |
| Beam diam. | 0,63m | 1,25m | 1,90m |

Lumoluce[®]

double your brightness

Lumoluce[®] België/Belgique

Neremweg 110
3700 Tongeren

Tel: +32 12 23 10 32

Fax: +32 12 23 41 18

sales@lumoluce-be.com

www.lumoluce-be.com