

Series HC25

- Ultra-reliable, heavy-duty Size 25 (2.5") encoder
- Complete electrical protection and noise immunity
- Environmentally sealed to NEMA 12 / IP54 or NEMA 4 / IP66
- Up to 5000 PPR



APPLICATION/INDUSTRY

The Dynapar brand Series HC25 is a rugged, reliable and economical encoder for industrial motion applications.

DESCRIPTION

Protection against installation problems such as wiring errors prevents the encoder from damage, while immunity to electrical noise keeps the encoder signals intact. A NEMA 4/IP66 sealing option protects against damage from contamination.

Packaged in an industry standard 2.5" enclosure, the Series HC25 offers a variety of mechanical options: servo or face mounting, and 1/4" or 3/8" shafts. Electrical options include: resolutions from 3,000 - 5,000 pulses/revolution; bidirectional operation with optional index; single ended open collector or push-pull outputs, or differential line drivers; and connector or cable exit terminations.

The Series HC25 utilizes the latest technology optical emitters and sensors, surface mount assembly and precisely fabricated metal components to deliver high reliability and performance in a compact and economical package.

FEATURES AND BENEFITS

Mechanical / Environmental Features

- Extended temperature range available
- Industry Standard, Size 25 Form Factor
- NEMA12 / IP54 or NEMA 4 / IP66 rating

Electrical Features

- Noise Immune to ESD, RFI and electrical transients
- High current outputs
- Over-Voltage protection
- Reverse Voltage protection
- Output Short-Circuit Protection

SPECIFICATIONS

STANDARD OPERATING CHARACTERISTICS

Code: Incremental
Resolution: 3000 to 5000 PPR (pulses/revolution)
Accuracy: (Worst case any edge to any other edge) $\pm 10.8^\circ$ /PPR
Format: Two channel quadrature (AB) with optional Index (Z) and complementary outputs
Phase Sense: A leads B for CW or CCW shaft rotation as viewed from the shaft end of the encoder; see Ordering Information
Quadrature Phasing: $90^\circ \pm 25^\circ$ electrical
Symmetry: $180^\circ \pm 25^\circ$ electrical
Index: $90^\circ \pm 25^\circ$ electrical (gated with B low)
Waveforms: Squarewave with rise and fall times less than 1 microsecond into a load capacitance of 1000 pF

ELECTRICAL

Input Power:
 4.5 min. to 26 VDC max. at 80 mA max., not including output loads
Outputs:
 7273 Open Collector: 30 VDC max., 40 mA sink max.
 7272 Push-Pull and Differential Line Driver: 40 mA sink or source
Frequency Response: 250 kHz
Electrical Protection: Overvoltage, reverse voltage and output short circuit protected
Noise Immunity: Tested to EN50082-2 (Heavy Industrial) for Electro Static Discharge, Radio Frequency Interference, Electrical Fast Transients, Conducted and Magnetic Interference

CONNECTIONS

Mating Connector:

7 pin, style MS3106A-16S-1S (MCN-N5);
 10 pin, style MS3106A-18-1S (MCN-N6)
 5 pin, style M12: Cable with connector available
 8 pin, style M12: Cable with connector available

MECHANICAL

Shaft Loading: 40 lbs. radial, 30 lbs. axial
Shaft Speed: 10,000 RPM max. (See Frequency Response)
Starting Torque: (max at 25 °C)
 HC525: 1.0 oz-in;
 HC625: 2.5 oz.-in
Moment of Inertia: 2.83×10^{-4} oz-in-sec²

ENVIRONMENTAL

Operating Temperature:
 Standard: 0 to +70 °C;
 Extended: -40 to +85 °C
Storage Temperature: -40 to +90 °C
Shock: 50 G's for 11 milliseconds duration
Vibration: 5 to 2000 Hz at 20 G's
Humidity: to 98% without condensation
Enclosure Rating:
 HC525: NEMA12/IP54 (dirt tight, splashproof);
 HC625: NEMA4/IP66 (dust proof, washdown)

Series HC25

ELECTRICAL CONNECTIONS

Prewired Cable or Accessory Cables with 7 or 10 Pin MS Connector - when Code 4= 0 to 6, or A, B, C, D or G

Note: Wire color codes are referenced here for models that are specified with pre-wired cable. Connector/cables are described in the Encoder Accessories section of this catalog and color-coding information is provided here for reference.

Pin	Function (If Used)	Wire Color Code	Cable* Accessory Color Code
A	Signal A	BRN	BRN
B	Signal B	ORN	ORN
C	Signal Z	YEL	YEL
D	Power Source	RED	RED
E	No Connection	—	—
F	Common	BLK	BLK
G	Case	GRN	GRN
H	Signal \bar{A}	BRN/WH	BRN/WH
I	Signal \bar{B}	ORN/WH	ORN/WH
J	Signal \bar{Z}	YEL/WH	YEL/WH

*Cable Accessory: P/N 14006350010

Pin	Function (If Used)	Wire Color Code	Cable* Accessory Color Code
A	Signal A	BRN	RED
B	Signal B	ORN	BLUE
C	Signal Z	YEL	YEL
D	Power Source	RED	WHT
E	No Connection	—	GRN
F	Common	BLK	BLK
G	Case	GRN	SHIELD

*Cable Accessory: P/N 14004310010

Pin	Function (If Used)	Cable Accessory Color Code
A	Signal A	BRN
B	Signal B	ORN
C	Signal \bar{A}	BRN/WHT
D	Power Source	RED
E	Signal \bar{B}	ORN/WHT
F	Common	BLK
G	Case	GRN

*Cable Accessory: P/N 108596

Cable Configuration: PVC jacket, 105 °C rated, overall foil shield; 3 twisted pairs 26 AWG (output signals), plus 2 twisted pairs 24 AWG (input power)

5 & 8 Pin M12 Accessory Cables - when Code 4= H to Z

Connector pin numbers and cable assembly wire color information is provided here for reference.

Encoder Function	Table 4 5 Pin Single Ended		Table 5 8 Pin Single Ended		Table 6 8 Pin Differential	
	Pin	Wire Color	Pin	Wire Color	Pin	Wire Color
Sig. A	4	BLK	1	BRN	1	BRN
Sig. B	2	WHT2	4	ORG	4	ORG
*Sig. Z	5	GRY	6	YEL	6	YEL
Power +V	1	BRN	2	RED	2	RED
Com	3	BLU	7	BLK	7	BLK
Sig. \bar{A}	—	—	—	—	3	BRN/WHT
Sig. \bar{B}	—	—	—	—	5	ORG/WHT
*Sig. \bar{Z}	—	—	—	—	8	YEL/WHT

* Index not provided on all models. See ordering information

Cable Configuration: PVC jacket, 105 °C rated, overall foil shield; 24 AWG conductors, minimum

See "Accessories" Section for Connectors and Cable Assemblies Ordering Information

Series HC25

Code 3: Mechanical

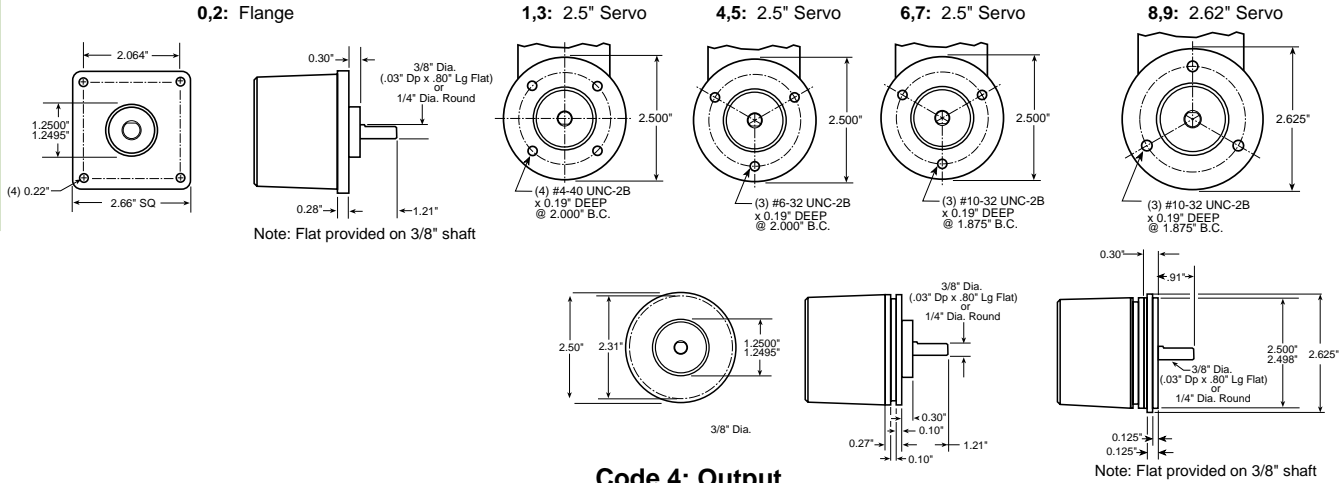

Code 4: Output

0 - 3: Format A

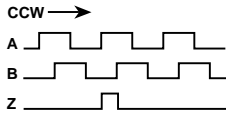

4,5: Format B

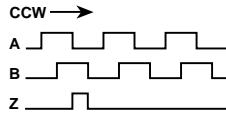

6 - D: Format C

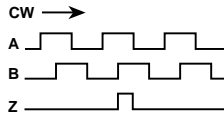

G: Format D

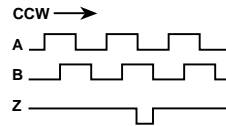

Code 6: Termination

0: End MS Connector 1: Side MS Connector
 When Code 4 is 0 to 6 or A to G

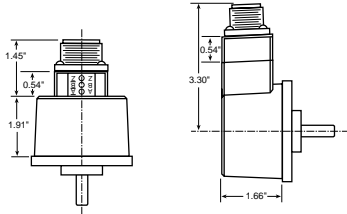

0: End M12 Connector 1: Side M12 Connector
 When Code 4 is H to Z

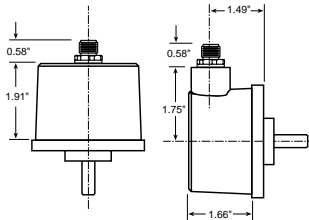

Code 6: 0 & 1 dimensions shown with LED Output Indicator Option (Code 7: PS)

2 - 6: Side Cable

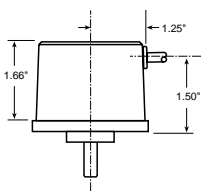

J - N: End Cable

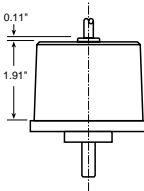

A - F: Side W.T. Cable

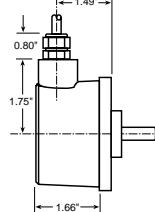

P - T: End W.T. Cable

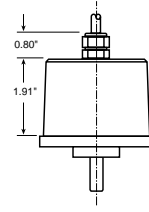

ORDERING INFORMATION

Series HC25

INDUSTRIAL

Code 1: Model	Code 2: PPR	Code 3: Mechanical	Code 4: Output	Code 5: Electrical	Code 6: Termination	Code 7: Options
HC <input type="checkbox"/> 25 <input type="checkbox"/> <input type="checkbox"/> <input type="checkbox"/> <input type="checkbox"/>	<input type="checkbox"/>	<input type="checkbox"/>	<input type="checkbox"/>	<input type="checkbox"/>	<input type="checkbox"/>	<input type="checkbox"/> <input type="checkbox"/>

Ordering Information							
HC525 Size 25 Enclosed, Shielded Bearings	3000 3,000	0 Flange Mount, 3/8" Shaft	7 Pin Connector or Cable	0 5-26V in; 5-26V Open Collector with 2.2kΩ Pullup out	0 End Mount Connector	Blank None available when Code 4 is 0 thru G, and Code 6 is 0 or 1:	
	3600 3,600	1 2.50" Servo Mount/ 4 Hole, 2.00" BC Face Mount, 3/8" Shaft	0 Single Ended, no Index, Format A, Table 2	1 5-26V in; 5-26V Open Collector out	1 Side Mount Connector		
HC625 Size 25 Enclosed, with Shaft Seal	4096 4,096	2 Flange Mount, 1/4" Shaft	1 Single Ended, with Index, Format A, Table 2	2 5-26V in; 5V Totem Pole out	Available when Code 1 is HC525:	PS LED Output Indicator	
	5000 5,000	3 2.50" Servo Mount/ 4 Hole 2.00" BC Face Mount, 1/4" Shaft	4 Single Ended, with Index, Format B, Table 2	3 5-26V in; 5V Line Driver out	2 18' Cable, Side		
		4 2.50" Servo Mount/ 3 Hole, 2.00" BC Face Mount, 3/8" Shaft	6 Differential, no Index, Format C, Table 3	A Single Ended, with Index, Format C, Table 2	4 5-26V in; 5-26V Line Driver out		3 3' Cable, Side
		5 2.50" Servo Mount/ 3 Hole, 2.00" BC Face Mount, 1/4" Shaft	A Single Ended, with Index, Format C, Table 2	C Single Ended, no Index, Format C, Table 2	5 5-26V in; 5V Totem Pole out		4 6' Cable, Side
		6 2.50" Servo Mount/ 3 Hole, 1.88" BC Face Mount, 3/8" Shaft	C Single Ended, no Index, Format C, Table 2	G Single Ended, with Index, Format D, Table 2	6 5-26V in; 5V Line Driver out		5 10' Cable, Side
		7 2.50" Servo Mount/ 3 Hole, 1.88" BC Face Mount, 1/4" Shaft	G Single Ended, with Index, Format D, Table 2		7 5-26V in; 5-26V Line Driver out		6 15' Cable, Side
		8 2.62" Servo Mount/ 3 Hole, 1.88" BC Face Mount, 3/8" Shaft			A Same as "0" with extend. temp range		J 18' Cable, End
		9 2.62" Servo Mount/ 3 Hole, 1.88" BC Face Mount, 1/4" Shaft			B Same as "1" with extend. temp range		K 3' Cable, End
					C Same as "2" with extend. temp range		L 6' Cable, End
					D Same as "3" with extend. temp range		M 10' Cable, End
				E Same as "4" with extend. temp range	N 15' Cable, End		
					Available when Code 1 is HC625:		
					A 18' Watertight, Side		
					B 3' Watertight, Side		
					C 6' Watertight, Side		
					D 10' Watertight, Side		
					F 15' Watertight, Side		
					P 18' Watertight, End		
					Q 3' Watertight, End		
					R 6' Watertight, End		
					S 10' Watertight, End		
					T 15' Watertight, End		