

Industrial Circuits Application Note

Stepper Motor Basics

A stepper motor is an electromechanical device which converts electrical pulses into discrete mechanical movements. The shaft or spindle of a stepper motor rotates in discrete step increments when electrical command pulses are applied to it in the proper sequence. The motors rotation has several direct relationships to these applied input pulses. The sequence of the applied pulses is directly related to the direction of motor shafts rotation. The speed of the motor shafts rotation is directly related to the frequency of the input pulses and the length of rotation is directly related to the number of input pulses applied.

Stepper Motor Advantages and Disadvantages

Advantages

1. The rotation angle of the motor is proportional to the input pulse.
2. The motor has full torque at stand-still (if the windings are energized)
3. Precise positioning and repeatability of movement since good stepper motors have an accuracy of 3 – 5% of a step and this error is non cumulative from one step to the next.
4. Excellent response to starting/stopping/reversing.
5. Very reliable since there are no contact brushes in the motor. Therefore the life of the motor is simply dependant on the life of the bearing.
6. The motors response to digital input pulses provides open-loop control, making the motor simpler and less costly to control.
7. It is possible to achieve very low speed synchronous rotation with a load that is directly coupled to the shaft.
8. A wide range of rotational speeds can be realized as the speed is proportional to the frequency of the input pulses.

Disadvantages

1. Resonances can occur if not properly controlled.
2. Not easy to operate at extremely high speeds.

Open Loop Operation

One of the most significant advantages of a stepper motor is its ability to be accurately controlled in an open loop system. Open loop control means no feedback information about position is needed. This type of control eliminates the need for expensive sensing and feedback devices such as optical encoders. Your position is known simply by keeping track of the input step pulses.

Stepper Motor Types

There are three basic stepper motor types. They are :

- Variable-reluctance
- Permanent-magnet
- Hybrid

Variable-reluctance (VR)

This type of stepper motor has been around for a long time. It is probably the easiest to understand from a structural point of view. Figure 1 shows a cross section of a typical V.R. stepper motor. This type of motor consists of a soft iron multi-toothed rotor and a wound stator. When the stator windings are energized with DC current the poles become magnetized. Rotation occurs when the rotor teeth are attracted to the energized stator poles.

Permanent Magnet (PM)

Often referred to as a “tin can” or “canstock” motor the permanent magnet step motor is a low cost and low resolution type motor with typical step angles of 7.5° to 15°. (48 – 24 steps/revolution) PM motors as the

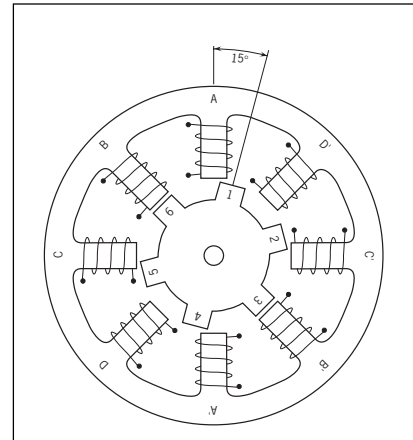

Figure 1. Cross-section of a variable-reluctance (VR) motor.

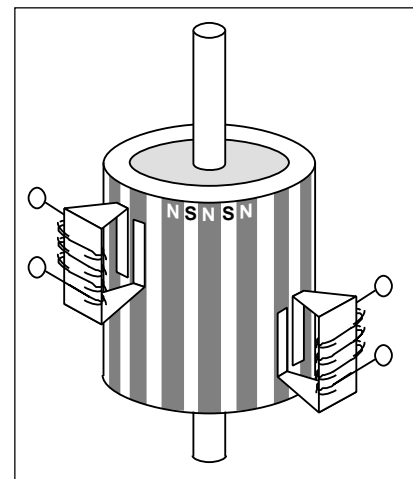

Figure 2. Principle of a PM or tin-can stepper motor.

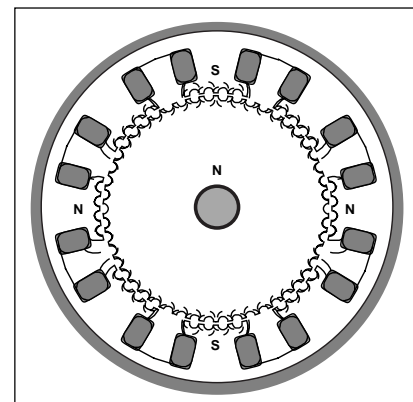

Figure 3. Cross-section of a hybrid stepper motor.

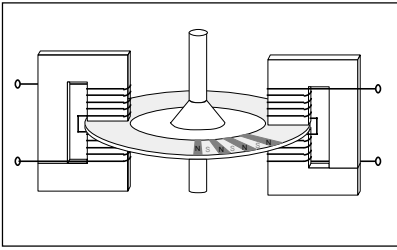

Figure 4. Principle of a disc magnet motor developed by Portescap.

name implies have permanent magnets added to the motor structure. The rotor no longer has teeth as with the VR motor. Instead the rotor is magnetized with alternating north and south poles situated in a straight line parallel to the rotor shaft. These magnetized rotor poles provide an increased magnetic flux intensity and because of this the PM motor exhibits improved torque characteristics when compared with the VR type.

Hybrid (HB)

The hybrid stepper motor is more expensive than the PM stepper motor but provides better performance with respect to step resolution, torque and speed. Typical step angles for the HB stepper motor range from 3.6° to 0.9° (100 – 400 steps per revolution). The hybrid stepper motor combines the best features of both the PM and VR type stepper motors. The rotor is multi-toothed like the VR motor and contains an axially magnetized concentric magnet around its shaft. The teeth on the rotor provide an even better path which helps guide the magnetic flux to preferred locations in the airgap. This further increases the detent, holding and dynamic torque characteristics of the motor when compared with both the VR and PM types.

The two most commonly used types of stepper motors are the permanent magnet and the hybrid types. If a designer is not sure which type will best fit his applications requirements he should first evaluate the PM type as it is normally several times less expensive. If not then the hybrid motor may be the right choice.

There also exist some special stepper motor designs. One is the disc magnet motor. Here the rotor is designed as a disc with rare earth magnets, See fig. 5. This motor type

has some advantages such as very low inertia and an optimized magnetic flow path with no coupling between the two stator windings. These qualities are essential in some applications.

Size and Power

In addition to being classified by their step angle stepper motors are also classified according to frame sizes which correspond to the diameter of the body of the motor. For instance a size 11 stepper motor has a body diameter of approximately 1.1 inches. Likewise a size 23 stepper motor has a body diameter of 2.3 inches (58 mm), etc. The body length may however, vary from motor to motor within the same frame size classification. As a general rule the available torque output from a motor of a particular frame size will increase with increased body length.

Power levels for IC-driven stepper motors typically range from below a watt for very small motors up to 10 – 20 watts for larger motors. The maximum power dissipation level or thermal limits of the motor are seldom clearly stated in the motor manufacturers data. To determine this we must apply the relationship $P = V \times I$. For example, a size 23 step motor may be rated at 6V and 1A per phase. Therefore, with two phases energized the motor has a rated power dissipation of 12 watts. It is normal practice to rate a stepper motor at the power dissipation level where the motor case rises 65°C above the ambient in still air. Therefore, if the motor can be mounted to a heatsink it is often possible to increase the allowable power dissipation level. This is important as the motor is designed to be and should be used at its maximum power dissipation, to be efficient from a size/output power/cost point of view.

When to Use a Stepper Motor

A stepper motor can be a good choice whenever controlled movement is required. They can be used to advantage in applications where you need to control rotation angle, speed, position and synchronism. Because of the inherent advantages listed previously, stepper motors have found their place

in many different applications. Some of these include printers, plotters, highend office equipment, hard disk drives, medical equipment, fax machines, automotive and many more.

The Rotating Magnetic Field

When a phase winding of a stepper motor is energized with current a magnetic flux is developed in the stator. The direction of this flux is determined by the “Right Hand Rule” which states:

“If the coil is grasped in the right hand with the fingers pointing in the direction of the current in the winding (the thumb is extended at a 90° angle to the fingers), then the thumb will point in the direction of the magnetic field.”

Figure 5 shows the magnetic flux path developed when phase B is energized with winding current in the direction shown. The rotor then aligns itself so that the flux opposition is minimized. In this case the motor would rotate clockwise so that its south pole aligns with the north pole of the stator B at position 2 and its north pole aligns with the south pole of stator B at position 6. To get the motor to rotate we can now see that we must provide a sequence of energizing the stator windings in such a fashion that provides a rotating magnetic flux field which the rotor follows due to magnetic attraction.

Torque Generation

The torque produced by a stepper motor depends on several factors.

- The step rate
- The drive current in the windings
- The drive design or type

In a stepper motor a torque is developed when the magnetic fluxes of the rotor and stator are displaced from each other. The stator is made up of a high permeability magnetic material. The presence of this high permeability material causes the magnetic flux to be confined for the most part to the paths defined by the stator structure in the same fashion that currents are confined to the conductors of an electronic circuit. This serves to concentrate the flux at the stator poles. The

torque output produced by the motor is proportional to the intensity of the magnetic flux generated when the winding is energized.

The basic relationship which defines the intensity of the magnetic flux is defined by:

$$H = (N \times i) \div l \quad \text{where:}$$

N = The number of winding turns

i = current

H = Magnetic field intensity

l = Magnetic flux path length

This relationship shows that the magnetic flux intensity and consequently the torque is proportional to the number of winding turns and the current and inversely proportional to the length of the magnetic flux path. From this basic relationship one can see that the same frame size stepper motor could have very different torque output capabilities simply by changing the winding parameters. More detailed information on how the winding parameters affect the output capability of the motor can be found in the application note entitled "Drive Circuit Basics".

Phases, Poles and Stepping Angles

Usually stepper motors have two phases, but three- and five-phase motors also exist.

A bipolar motor with two phases has one winding/phase and a unipolar motor has one winding, with a center tap per phase. Sometimes the unipolar stepper motor is referred to as a "four-phase motor", even though it only has two phases.

Motors that have two separate windings per phase also exist—these can be driven in either bipolar or unipolar mode.

A pole can be defined as one of the regions in a magnetized body where the magnetic flux density is concentrated. Both the rotor and the stator of a step motor have poles. Figure 2 contains a simplified picture of a two-phase stepper motor having 2 poles (or 1 pole pairs) for each phase on the stator, and 2 poles (one pole pair) on the rotor. In reality several more poles are added to both the rotor and stator structure in order to

increase the number of steps per revolution of the motor, or in other words to provide a smaller basic (full step) stepping angle. The permanent magnet stepper motor contains an equal number of rotor and stator pole pairs. Typically the PM motor has 12 pole pairs. The stator has 12 pole pairs per phase. The hybrid type stepper motor has a rotor with teeth. The rotor is split into two parts, separated by a permanent magnet—making half of the teeth south poles and half north poles. The number of pole pairs is equal to the number of teeth on one of the rotor halves. The stator of a hybrid motor also has teeth to build up a higher number of equivalent poles (smaller pole pitch, number of equivalent poles = $360/\text{teeth pitch}$) compared to the main poles, on which the winding coils are wound. Usually 4 main poles are used for 3.6 hybrids and 8 for 1.8- and 0.9-degree types.

It is the relationship between the number of rotor poles and the equivalent stator poles, and the number the number of phases that determines the full-step angle of a stepper motor.

$$\text{Step angle} = 360 \div (N_{ph} \times Ph) = 360/N$$

N_{ph} = Number of equivalent poles per phase = number of rotor poles

Ph = Number of phases

N = Total number of poles for all phases together

If the rotor and stator tooth pitch is unequal, a more-complicated relationship exists.

Stepping Modes

The following are the most common drive modes.

- Wave Drive (1 phase on)
- Full Step Drive (2 phases on)
- Half Step Drive (1 & 2 phases on)
- Microstepping (Continuously varying motor currents)

For the following discussions please refer to the figure 6.

In Wave Drive only one winding is energized at any given time. The stator is energized according to the sequence $A \rightarrow B \rightarrow \bar{A} \rightarrow \bar{B}$ and the rotor steps from position $8 \rightarrow 2 \rightarrow 4 \rightarrow 6$. For unipolar and bipolar wound

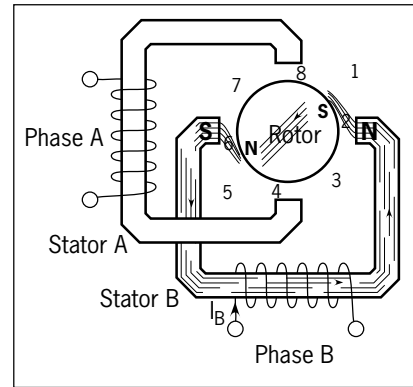

Figure 5. Magnetic flux path through a two-pole stepper motor with a lag between the rotor and stator.

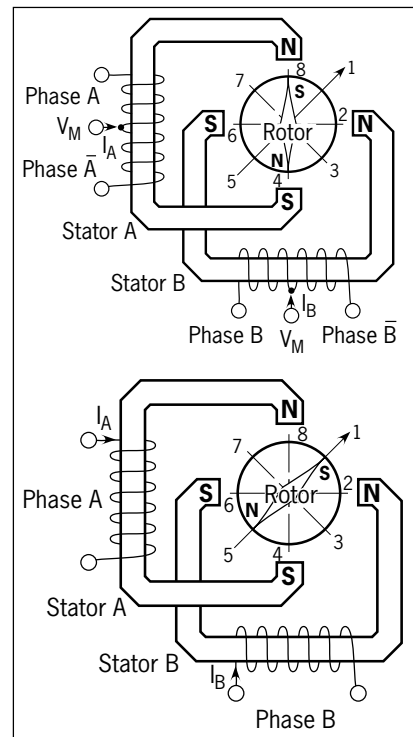

Figure 6. Unipolar and bipolar wound stepper motors.

motors with the same winding parameters this excitation mode would result in the same mechanical position. The disadvantage of this drive mode is that in the unipolar wound motor you are only using 25% and in the bipolar motor only 50% of the total motor winding at any given time. This means that you are not getting the maximum torque output from the motor

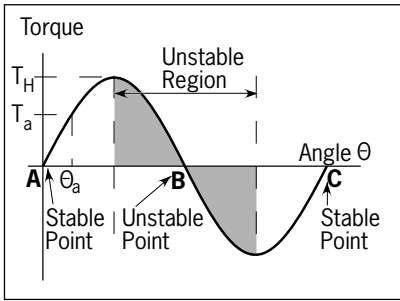

Figure 7. Torque vs. rotor angular position.

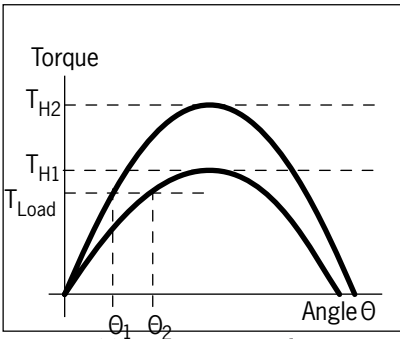

Figure 8. Torque vs. rotor angle position at different holding torque.

In Full Step Drive you are energizing two phases at any given time. The stator is energized according to the sequence $AB \rightarrow \bar{A}B \rightarrow \bar{A}\bar{B} \rightarrow A\bar{B}$ and the rotor steps from position $1 \rightarrow 3 \rightarrow 5 \rightarrow 7$. Full step mode results in the same angular movement as 1 phase on drive but the mechanical position is offset by one half of a full step. The torque output of the unipolar wound motor is lower than the bipolar motor (for motors with the same winding parameters) since the unipolar motor uses only 50% of the available winding while the bipolar motor uses the entire winding.

Half Step Drive combines both wave and full step (1&2 phases on) drive modes. Every second step only one phase is energized and during the other steps one phase on each stator. The stator is energized according to the sequence $AB \rightarrow B \rightarrow \bar{A}B \rightarrow \bar{A} \rightarrow \bar{A}\bar{B} \rightarrow \bar{B} \rightarrow A\bar{B} \rightarrow A$ and the rotor steps from position $1 \rightarrow 2 \rightarrow 3 \rightarrow 4 \rightarrow 5 \rightarrow 6 \rightarrow 7 \rightarrow 8$. This results in angular movements that are half of those in 1- or 2-phases-on drive modes. Half stepping can reduce a phenomena referred to as resonance which can be experienced in 1- or 2-phases-on drive modes.

The excitation sequences for the above drive modes are summarized in Table 1.

In Microstepping Drive the currents in the windings are continuously varying to be able to break up one full step into many smaller discrete steps. More information on microstepping can be found in the microstepping chapter.

Torque vs, Angle Characteristics

The torque vs angle characteristics of a stepper motor are the relationship between the displacement of the rotor and the torque which applied to the rotor shaft when the stepper motor is energized at its rated voltage. An ideal stepper motor has a sinusoidal torque vs displacement characteristic as shown in figure 8.

Positions A and C represent stable equilibrium points when no external force or load is applied to the rotor shaft. When you apply an external force T_a to the motor shaft you in essence create an angular displacement, Θ_a . This angular displacement, Θ_a , is referred to as a lead or lag angle depending on whether the motor is actively accelerating or decelerating. When the rotor stops with an applied load it will come to rest at the position defined by this displacement angle. The motor develops a torque, T_a , in opposition to the applied external force in order to balance the load. As the load is increased the displacement angle also increases until it reaches the maximum holding torque, T_h , of the motor. Once T_h is exceeded the motor enters an unstable region. In this region a torque is the opposite direction is created and the rotor jumps over the unstable point to the next stable point.

The displacement angle is determined by the following relationship:

$$X = (Z \div 2\pi) \times \sin(T_a \div T_h) \quad \text{where:}$$

Z = rotor tooth pitch

T_a = Load torque

T_h = Motors rated holding torque

X = Displacement angle.

Therefore if you have a problem with the step angle error of the loaded motor at rest you can improve this by changing the “stiffness” of the motor. This is done by increasing the holding torque of the motor. We can see this effect shown in the figure 5. Increasing the holding torque for a constant load causes a shift in the lag angle from Q_2 to Q_1 .

Step Angle Accuracy

One reason why the stepper motor has achieved such popularity as a positioning device is its accuracy and repeatability. Typically stepper motors will have a step angle accuracy of 3 – 5% of one step. This error is also non-cumulative from step to step. The accuracy of the stepper motor is mainly a function of the mechanical precision of its parts and assembly. Figure 9 shows a typical plot of the positional accuracy of a stepper motor.

Step Position Error

The maximum positive or negative position error caused when the motor has rotated one step from the previous holding position.

Step position error = measured step angle - theoretical angle

Positional Error

The motor is stepped N times from an initial position ($N = 360^\circ/\text{step angle}$) and the angle from the initial position

Table 1. Excitation sequences for different drive modes

Phase	Wave Drive				Normal full step				Half-step drive							
	1	2	3	4	1	2	3	4	1	2	3	4	5	6	7	8
A
B							
\bar{A}							
\bar{B}			

is measured at each step position. If the angle from the initial position to the N-step position is Θ_N and the error is $\Delta\Theta_N$ where:

$$\Delta\Theta_N = \Delta\Theta_N - (\text{step angle}) \times N.$$

The positional error is the difference of the maximum and minimum but is usually expressed with a \pm sign. That is:

$$\text{positional error} = \pm \frac{1}{2}(\Delta\Theta_{\text{Max}} - \Delta\Theta_{\text{Min}})$$

Hysteresis Positional Error

The values obtained from the measurement of positional errors in both directions.

Mechanical Parameters, Load, Friction, Inertia

The performance of a stepper motor system (driver and motor) is also highly dependent on the mechanical parameters of the load. The load is defined as what the motor drives. It is typically frictional, inertial or a combination of the two.

Friction is the resistance to motion due to the unevenness of surfaces which rub together. Friction is constant with velocity. A minimum torque level is required throughout the step in order to overcome this friction (at least equal to the friction). Increasing a frictional load lowers the top speed, lowers the acceleration and increases the positional error. The converse is true if the frictional load is lowered.

Inertia is the resistance to changes in speed. A high inertial load requires a high inertial starting torque and the same would apply for braking. Increasing an inertial load will increase speed stability, increase the amount of time it takes to reach a desired speed and decrease the maximum self start pulse rate. The converse is again true if the inertia is decreased.

The rotor oscillations of a stepper motor will vary with the amount of friction and inertia load. Because of this relationship unwanted rotor oscillations can be reduced by mechanical damping means however it is more often simpler to reduce these unwanted oscillations by electrical damping methods such as switch from full step drive to half step drive.

Torque vs, Speed Characteristics

The torque vs speed characteristics are the key to selecting the right motor and drive method for a specific application. These characteristics are dependent upon (change with) the motor, excitation mode and type of driver or drive method. A typical "speed - torque curve" is shown in figure 9.

To get a better understanding of this curve it is useful to define the different aspects of this curve.

Holding torque

The maximum torque produced by the motor at standstill.

Pull-In Curve

The pull-in curve defines an area referred to as the start stop region. This is the maximum frequency at which the motor can start/stop instantaneously, with a load applied, without loss of synchronism.

Maximum Start Rate

The maximum starting step frequency with no load applied.

Pull-Out Curve

The pull-out curve defines an area referred to as the slew region. It defines the maximum frequency at which the motor can operate without losing synchronism. Since this region is outside the pull-in area the motor must be ramped (accelerated or decelerated) into this region.

Maximum Slew Rate

The maximum operating frequency of the motor with no load applied.

The pull-in characteristics vary also depending on the load. The larger the load inertia the smaller the pull-in area. We can see from the shape of the curve that the step rate affects the torque output capability of a stepper motor. The decreasing torque output as the speed increases is caused by the fact that at high speeds the inductance of the motor is the dominant circuit element.

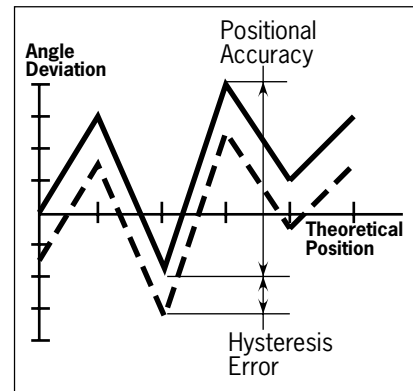

Figure 9. Positional accuracy of a stepper motor.

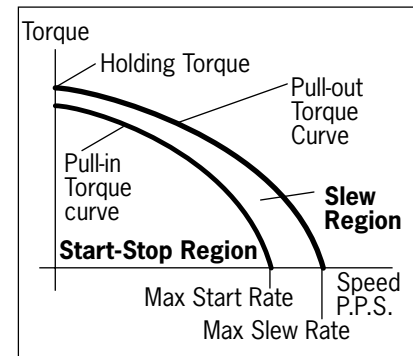

Figure 10. Torque vs. speed characteristics of a stepper motor.

The shape of the speed - torque curve can change quite dramatically depending on the type of driver used. The bipolar chopper type drivers which Ericsson Components produces will maximize the speed - torque performance from a given motor. Most motor manufacturers provide these speed - torque curves for their motors. It is important to understand what driver type or drive method the motor manufacturer used in developing their curves as the torque vs. speed characteristics of a given motor can vary significantly depending on the drive method used.

Single Step Response and Resonances

The single-step response characteristics of a stepper motor is shown in figure 11.

When one step pulse is applied to a stepper motor the rotor behaves in a manner as defined by the above curve. The step time t is the time it takes the motor shaft to rotate one step angle once the first step pulse is applied. This step time is highly dependent on the ratio of torque to inertia (load) as well as the type of driver used.

Since the torque is a function of the displacement it follows that the acceleration will also be. Therefore, when moving in large step increments a high torque is developed and consequently a high acceleration. This can cause overshoots and ringing as shown. The settling time T is the time it takes these oscillations or ringing to cease. In certain applications this phenomena can be undesirable. It is possible to reduce or eliminate this behaviour by microstepping the stepper motor. For more information on microstepping please consult the microstepping note.

Stepper motors can often exhibit a phenomena referred to as resonance at certain step rates. This can be seen as a sudden loss or drop in torque at certain speeds which can result in missed steps or loss of synchronism. It occurs when the input step pulse rate coincides with the natural oscillation frequency of the rotor. Often there is a resonance area around the 100 – 200 pps region and also one in the high step pulse rate region. The resonance phenomena of a stepper motor comes from its basic construction and therefore it is not possible to eliminate it completely. It is also dependent upon the load conditions. It can be reduced by driving the motor in half or microstepping modes.

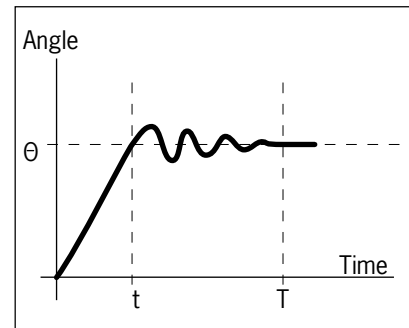

Figure 11. Single step response vs. time.