



TSE-S800-5.1D  
BULLETIN

VS-800 SERIES

# AC Servo Drives

## WITH ABSOLUTE ENCODER M, F, S, D SERIES FOR SPEED CONTROL

**Servomotor** TYPES USAM□□D, USAFED, USASEM, USADED  
**Servopack**™ TYPES CACR-SR□□□ BZ1S□

Yaskawa AC Servo Drives with absolute encoder have been developed as the basic mechatronics drives for the most advanced FA and FMS including robots and machine tools. In addition, a D series, shorter type in the axis direction, has been produced. The most suitable selection can be possible for your application.

This bulletin covers AC servo drives M, F and S series for speed control. The AC Servo Drives consist primarily of AC servomotors and their controllers, Servopacks. The AC servomotor features a high power rate for achieving quick response. Custom LSI and hybrid ICs packaged in Servopack reduce the unit size and simplify wiring. The additional feature of a highly accurate pulse resolution offers stopless pulse flow.

For your mechatronics systems, the flexible combination of our AC servomotor and Servopack achieves stable control operation with high accuracy, quick response control under any environmental condition, and smooth, powerful operation even at low-speed range. Some outstanding features are as follows.

- High accuracy and quick response for speed control
- Compact design and high reliability
- Light weight and high power
- Highly reliable protective functions
- Selectable drive to meet users' requirements
- Continuous operation after power failure available by absolute encoder

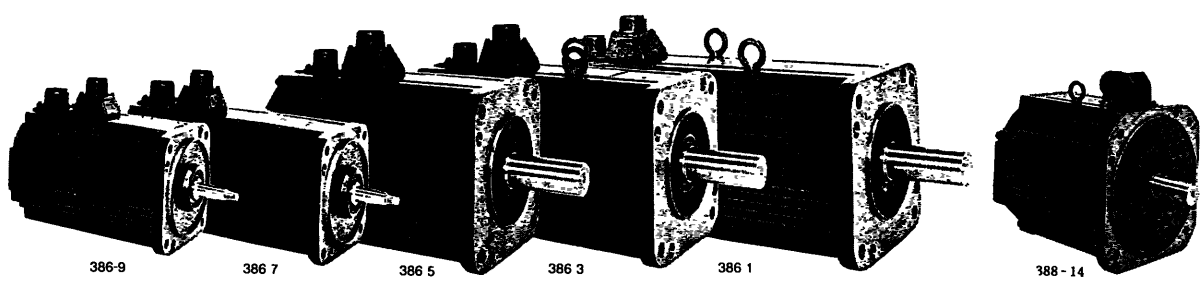
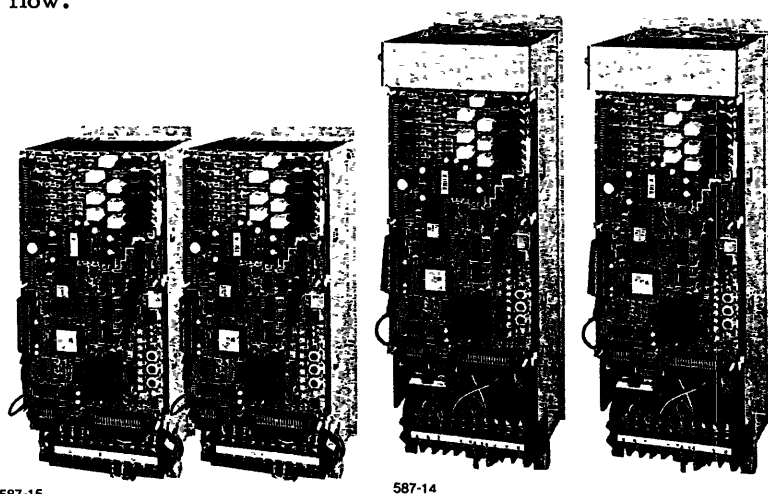

M Series AC Servo Drives with Absolute Encoder for Speed Control  
— AC Servomotors and Their Controllers Servopacks

# CONTENTS

<b>1. RATINGS AND SPECIFICATIONS</b>	<b>1</b>	6 5 PROTECTIVE CIRCUIT	36
1 1 RATINGS AND SPECIFICATIONS OF M SERIES AC SERVOMOTORS	1	6 6 LED INDICATION	37
1 2 RATINGS AND SPECIFICATIONS OF F SERIES AC SERVOMOTORS	3	6 7 PRECAUTIONS FOR APPLICATION	37
1 3 RATINGS AND SPECIFICATIONS OF S SERIES AC SERVOMOTORS	5	6 8 PRECAUTIONS OF OPERATION	37
1 4 RATINGS AND SPECIFICATIONS OF D SERIES AC SERVOMOTORS	7	6 9 APPLICATION	39
1 5 RATINGS AND SPECIFICATIONS OF <i>Servopack</i>	9	<b>7. INSTALLATION AND WIRING</b>	<b>40</b>
<b>2. TYPE DESIGNATION</b>	<b>11</b>	7 1 RECEIVING	40
<b>3. LIST OF STANDARD COMBINATION</b>	<b>12</b>	7 2 INSTALLATION	40
<b>4. CHARACTERISTICS</b>	<b>15</b>	7 3 WIRING	41
4 1 OVERLOAD CHARACTERISTICS	15	<b>8. DIMENSIONS in mm (inches)</b>	<b>43</b>
4 2 STARTING AND STOPPING TIME	15	8 1 AC SERVOMOTOR M SERIES	43
4 3 ALLOWABLE FREQUENCY OF OPERATION	15	8 2 AC SERVOMOTOR F SERIES	45
4 4 SERVOMOTOR FREQUENCY	16	8 3 AC SERVOMOTOR S SERIES	47
4 5 MOTOR SPEED-REFERENCE INPUT CHARACTERISTICS	16	8 4 <i>Servopack</i>	49
4 6 MOTOR MECHANICAL CHARACTERISTICS	16	<b>9. TEST RUN</b>	<b>50</b>
<b>5. CONFIGURATION</b>	<b>19</b>	9 1 CHECK ITEMS BEFORE TEST RUN	50
5 1 CONNECTION DIAGRAM	19	9 2 TEST RUN PROCEDURES	50
5 2 INTERNAL BLOCK DIAGRAM	20	<b>10. ADJUSTMENT</b>	<b>51</b>
5 3 EXTERNAL TERMINALS	22	10 1 SETTINGS AT THE TIME OF DELIVERY	51
5 4 CONNECTOR TERMINAL (1CN) FOR INPUT/OUTPUT SIGNAL	22	10 2 CHARACTERISTICS AT THE TIME OF DELIVERY	55
5 5 CONNECTOR TERMINAL (2CN) FOR ABSOLUTE ENCODER(PG)CONNECTION	25	10 3 READJUSTMENT	55
<b>6. OPERATION</b>	<b>27</b>	10 4 ADJUSTMENT PROCEDURES	56
6 1 POWER ON AND OFF	27	10 5 SWITCH SETTING	60
6 2 SPEED REFERENCE	28	<b>11. INSPECTION AND MAINTENACE</b>	<b>61</b>
6.3 EXTERNAL CURRENT LIMIT REFERENCE CIRCUIT [P-CL, N-CL]	29	11 1 AC SERVOMOTER	61
6 4 CONFIGURATION OF INPUT/OUTPUT CIRCUIT	30	11 2 <i>Servopack</i>	61
		11 3 BATTERY REPLACEMENT METHOD	61
		<b>12. TROUBLESHOOTING GUIDE</b>	<b>62</b>
		12 1 AC SERVOMOTOR	62
		12 2 <i>Servopack</i>	63

# INDEX

Subject	Section No	Page
A AC SERVOMOTOR .....	12 1	62
AC Servomotor (Test run) .....	9 1 1	50
AC SERVOMOTOR . F SERIES .....	8 2	45
AC SERVOMOTOR . M SERIES .....	8 1	43
AC SERVOMOTOR S SERIES .....	8 3	47
AC SERVOMOTOR (Inspection and maintenance) .....	11.1	61
AC Servomotor (Installation) .....	7 2 1	40
ADJUSTMENT .....	10	51
ADJUSTMENT PROCEDURES .....	10 4	56
ALLOWABLE FREQUENCY OF OPERATION .....	4 3	15
Allowable Radial Load and Thrust Load .....	4 6 2	17
APPLICATION .....	6 9	39
Application of Servomotors with Holding Magnetic Brake .....	6 9 3	40
Auxiliary Input Circuit (+2 to +10 V) .....	6 2 4	28
B BATTERY REPLACEMENT METHOD .....	11 3	61
C CHARACTERISTICS .....	4	15
CHARACTERISTICS AT THE TIME OF DELIVERY .....	10 2	55
CHECK ITEMS BEFORE TEST RUN .....	9 1	50
CONFIGURATION .....	5	19
CONFIGURATION OF INPUT/OUTPUT CIRCUIT .....	6 4	30
CONNECTION DIAGRAM .....	5 1	19
Connection for Reverse Motor Running .....	6 9 1	39
Connector 1CN Layout and Connection of Servopack .....	5 4 2	22
CONNECTOR TERMINAL (1CN) FOR INPUT/OUTPUT SIGNAL .....	5 4	22
CONNECTOR TERMINAL (2CN) FOR ABSOLUTE ENCODER CONNECTION .....	5 5	25
Current Limit when Motor is Locked .....	6 3 3	29
D DIMENSIONS in mm (inches) .....	8	43
Direction of Rotation .....	4 6.4	17
E Examples or Troubleshooting for Defective Wiring or Parts .....	12 2 2	64
Examples of Troubleshooting for Incomplete Adjustment .....	12 2 3	65
EXTERNAL CURRENT LIMIT REFERENCE CIRCUIT (P-CL, N-CL) .....	6 3	29
EXTERNAL TERMINALS .....	5.3	22
H Handling of Speed Reference Input Terminal .....	6 2 3	28
High Voltage Line .....	6 7 3	37
Holdig Brake .....	4.6 8	18
I Impact Resistance .....	4 6 5	18
Input Circuit .....	6.4 1	30
INSPECTION AND MAINTENANCE .....	11	61
Inspection during Test Run .....	9 2 3	50
INSTALLATION .....	7.2	40
INSTALLATION AND WIRING .....	7	40
INTERNAL BLOCK DIAGRAM .....	5 2	20
L LED INDICATION .....	6 6	37
LED Indication (7-segment) for Troubleshooting .....	12.2 1	63
LIST OF STANDARD COMBINATION .....	3	12
Load Inertia (J <sub>L</sub> ) .....	6 7 2	37
M Mechanical Specifications (M, F, S and D) .....	4 6.3	17
Mechanical Strength .....	4 6 1	16
Method of Giving External Current Limit Reference .....	6 3 1	29
Minus Load .....	6 7 1	37
MOTOR MECHANICAL CHARACTERISTICS .....	4 6	16
MOTOR SPEED-REFERENCE INPUT CHARACTERISTICS .....	4 5	16
N Noise Treatment .....	6 8 1	37
O OPERATION .....	6	27
Operation (Test run) .....	9 2 2	50
Output Circuit .....	6 4 2	30
OVERLOAD CHARACTERISTICS .....	4 1	15

## INDEX (Cont'd)

Subject	Section No.	Page
P Power Line Protection .....	6 8 2	39
Power Loss .....	7 3 3	42
POWER ON AND OFF .....	6 1	27
PRECAUTIONS FOR APPLICATION .....	6 7	37
PRECAUTIONS OF OPERATION .....	6 8	37
Preparation of Operation .....	9.2 1	50
PROTECTIVE CIRCUIT .....	6 5	36
R Rated Current and Cable Size .....	7 3 1	41
RATINGS AND SPECIFICATIONS OF D SERIES AC SERVOMOTORS .....	1 4	7
RATINGS AND SPECIFICATIONS OF F SERIES AC SERVOMOTORS .....	1 2	3
RATINGS AND SPECIFICATIONS OF M SERIES AC SERVOMOTORS .....	1 1	1
RATINGS AND SPECIFICATIONS OF S SERIES AC SERVOMOTORS .....	1 3	5
RATINGS AND SPECIFICATIONS OF Servopack .....	1 5	9
RATINGS AND SPECIFICATIONS .....	1	1
Ratings (D series) .....	1 4 1	7
Ratings (F series) .....	1 2 1	3
Ratings (M series) .....	1 1 1	1
Ratings (S series) .....	1.3 1	5
READJUSTMENT .....	10 3	55
RECEIVING .....	7 1	40
S SERVOMOTOR FREQUENCY .....	4 4	16
Servopack .....	12.2	63
Servopack (Dimensions) .....	8 4	49
Servopack (Test run) .....	9.1 2	50
Servopack Connector (2CN) Terminal Layout and Connection .....	5 5 2	25
Servopack (Inspection and maintenance) .....	11 2	61
Servopack (Installation) .....	7 2 2	41
Set Voltage and Current Limit Values .....	6.3 2	29
SETTINGS AT THE TIME OF DELIVERY .....	10.1	51
Setup of Absolute Encoder .....	9 2 4	50
Specifications of Applicable Receptacles .....	5 4.1	22
Specifications of Applicable Receptacles and Cables (Table 5 6) .....	5 5 1	25
Speed and Torque Measurement .....	6 9.2	39
SPEED REFERENCE .....	6 2	28
Speed Reference Circuit .....	6 2.1	28
STARTING AND STOPPING TIME .....	4.2	15
Stop Reference Circuit .....	6.2.2	28
SWITCH SETTING .....	10.5	60
T TEST RUN .....	9	50
TEST RUN PROCEDURES .....	9.2	50
Torque-Speed Characteristics (D series) .....	1 4.2	8
Torque-Speed Characteristics (F series) .....	1.2.2	4
Torque-Speed Characteristics (M series) .....	1.1.2	2
Torque-Speed Characteristics (S series) .....	1.3.2	6
TROUBLESHOOTING GUIDE .....	12	62
TYPE DESIGNATION .....	2	11
U Use of Absolute Encoder .....	6.4 3	31
V Vibration Class .....	4 6.7	18
Vibration Resistance .....	4 6.6	18
W WIRING .....	7 3	41
Wiring Precautions .....	7 3 2	42

# 1. RATINGS AND SPECIFICATIONS

## 1.1 RATINGS AND SPECIFICATIONS OF M SERIES AC SERVO MOTORS

### 1.1.1 Ratings

Time Rating Continuous

Insulation Class F

Isolation Voltage 1500 VAC, one minute

Insulation Resistance 500 VDC, 10MΩ or more

Enclosure Totally-enclosed, self-cooled  
(Equivalent to IP-55 exclusive shaft opening)

Ambient Temperature 0 to +40°C

Ambient Humidity 20% to 80% (non-condensing)

Vibration 15 μm or below

Finish in Munsell Notation N1.5

Excitation Permanent magnet

Mounting Flange mounted

Drive Method Direct drive

Table 1.1 Ratings and Specifications of M Series AC Servomotors

Item	Motor Type USAMED-	03MS1	06MS1	09MS2	12MS2	20MS2	30MS2	44MS2	USAMKD-60MS2
Rated Output*	kW (HP)	0.3 (0.4)	0.6 (0.8)	0.9 (1.2)	1.2 (1.6)	2.0 (2.7)	3.0 (4.1)	4.4 (6.0)	6.0 (8.2)
Rated Torque*	N·m (lb·in)	2.8 (25)	5.7 (50)	8.6 (76)	11.5 (102)	19.1 (169)	28.4 (252)	41.9 (372)	57.2 (507)
Continuous Max Torque*	N·m (lb·in)	2.9 (26)	5.9 (52)	8.8 (78)	11.8 (104)	21.6 (191)	32.3 (286)	46.1 (408)	62.9 (557)
Instantaneous Peak Torque*	N·m (lb·in)	7.2 (63)	14.1 (125)	19.3 (171)	28.0 (248)	44.0 (390)	63.7 (564)	91.1 (807)	105.8 (938)
Rated Current*	A	3.0	5.8	7.6	11.7	18.8	26	33	45
Rated Speed*	r/min	1000							
Instantaneous Max Speed*	r/min	2000						1500	
Torque Constant	N·m/A (lb·in/A)	1.01 (8.9)	1.04 (9.2)	1.21 (10.7)	1.02 (9.0)	1.07 (9.5)	1.15 (10.2)	1.33 (11.8)	1.33 (11.8)
Moment of Inertia $J_M (=GD^2/4)$	kg·cm <sup>2</sup> (lb·in·s <sup>2</sup> ×10 <sup>-3</sup> )	13.5 (12.0)	24.3 (21.5)	36.7 (32.5)	66.8 (59.2)	110 (97.2)	143 (126.7)	240 (212.6)	240 (212.6)
Power Rate*	kW/s	6.1	13.3	20.3	19.7	33.2	57.0	74.0	138
Inertia Time Constant	ms	8.3	5.9	4.6	6.9	5.2	4.1	4.0	4.0
Inductive Time Constant	ms	4.2	5.4	6.5	10.4	12.9	15.3	16.2	16.2
Insulation	Class F								

\*Values when servomotor is combined with Servopack and the armature winding temperature is 20°C. Shown are normal (TYP) values above.

# 1 1 2 Torque-Speed Characteristics

## • TYPE USAMED-03MA1

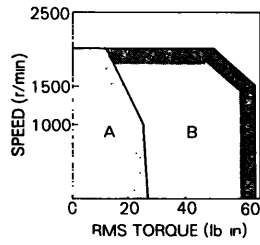
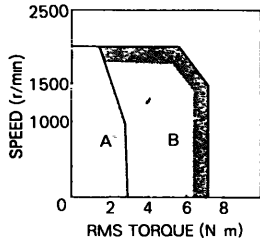

## • TYPE USAMED-20MA2

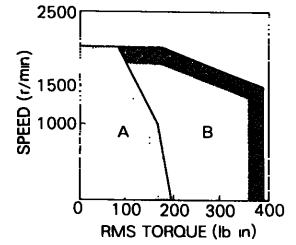
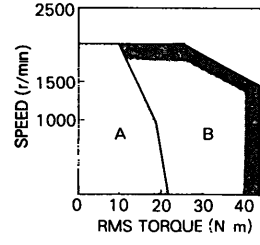

## • TYPE USAMED-06MA1

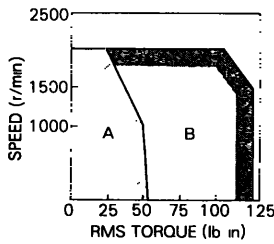
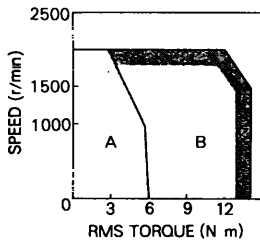

## • TYPE USAMED-30MA2

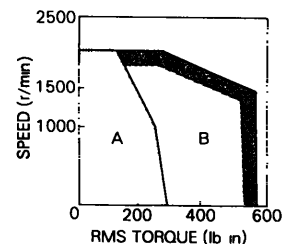
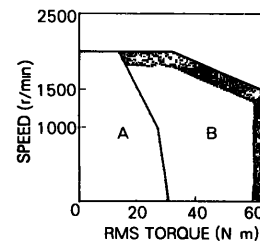

## • TYPE USAMED-09MA2

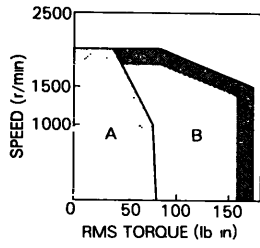
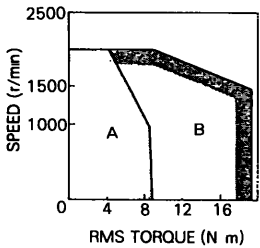

## • TYPE USAMED-44MA2

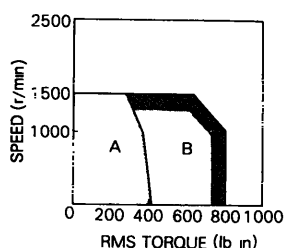
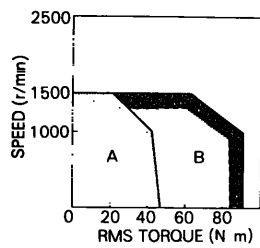

## • TYPE USAMED-12MA2

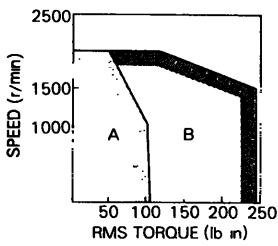
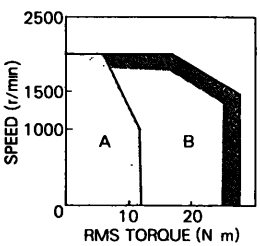

## • TYPE USAMKD-60MA2

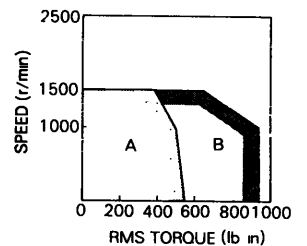
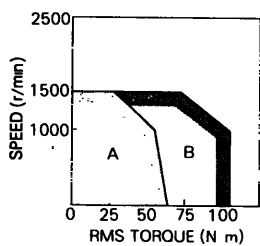

A CONTINUOUS DUTY ZONE  
 B INTERMITTENT DUTY ZONE  
 POWER SUPPLY 200V

## 1.2 RATINGS AND SPECIFICATIONS OF F SERIES AC SERVOMOTORS

### 1.2.1 Ratings

**Time Rating** Continuous  
**Insulation** Class F  
**Isolation Voltage** 1500 VAC, one minute  
**Insulation Resistance** 500 VDC, 10MΩ or more  
**Enclosure** Totally-enclosed, self-cooled  
 (Equivalent to IP-55 exclusive shaft opening)

**Ambient Temperature** 0 to +40°C  
**Ambient Humidity** 20% to 80% (non-condensing)  
**Vibration** 15 μm or below  
**Finish in Munsell Notation** N1.5  
**Excitation** Permanent magnet  
**Mounting** Flange mounted  
**Drive Method** Direct drive

Table 1.2 Ratings and Specifications of F Series AC Servomotors

Motor Type USAFED-		02FS1	03FS1	05FS1	09FS1	13FS2	20FS2	30FS2	44FS2
Rated Output*	kW (HP)	0.15 (0.2)	0.3 (0.4)	0.45 (0.6)	0.85 (1.2)	1.3 (1.8)	1.8 (2.4)	2.9 (3.9)	4.4 (6.0)
Rated Torque*	N·m (lb·in)	1.0 (8.7)	2.0 (17)	2.8 (25)	5.4 (48)	8.3 (74)	11.5 (102)	18.6 (165)	28.4 (252)
Continuous Max Torque*	N·m (lb·in)	1.1 (10)	2.2 (19)	2.9 (26)	5.9 (52)	8.8 (78)	11.8 (104)	22.5 (200)	37.2 (330)
Instantaneous Peak Torque*	N·m (lb·in)	2.9 (26)	5.7 (52)	8.9 (79)	15.2 (135)	24.7 (219)	34.0 (301)	54.1 (479)	76.2 (675)
Rated Current*	A	3.0	3.0	3.8	6.2	9.7	15	20	30
Rated Speed*	r/min	1500							
Instantaneous Max Speed*	r/min	2500							
Torque Constant	N·m/A (lb·in/A)	0.36 (3.2)	0.71 (6.3)	0.8 (7.1)	0.93 (8.2)	0.93 (8.2)	0.82 (7.3)	0.98 (8.7)	1.02 (9.0)
Moment of Inertia $J_M (=GD^2/4)$	kg·cm <sup>2</sup> (lb·in·s <sup>2</sup> ×10 <sup>-3</sup> )	1.30 (1.2)	2.06 (1.8)	13.5 (12.0)	24.3 (21.5)	36.7 (32.5)	66.8 (59.2)	110 (97.2)	143 (126.7)
Power Rate*	kW/s	7.4	18.3	6.0	12	18.9	19.7	31.5	57.0
Inertia Time Constant	ms	4.5	2.5	8.3	5.7	4.7	6.8	5.1	4.1
Inductive Time Constant	ms	3.4	4.3	4.2	5.5	6.4	10.4	13.0	15.2
Insulation		Class F							

\*Values when servomotor is combined with Servopack and the armature winding temperature is 20°C. Shown are normal (TYP) values above.

## 1 2 2 Torque-Speed Characteristics

### • TYPE USAFED-02F

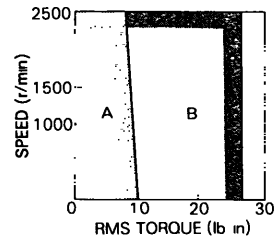
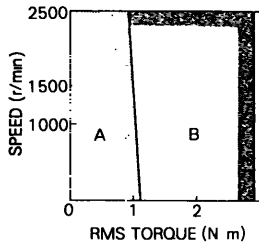

### • TYPE USAFED-13F

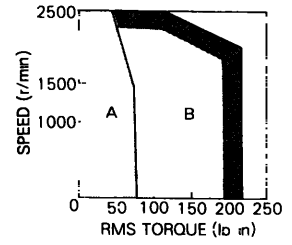
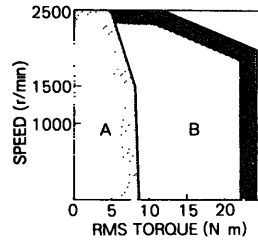

### • TYPE USAFED-03F

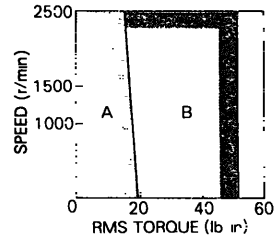
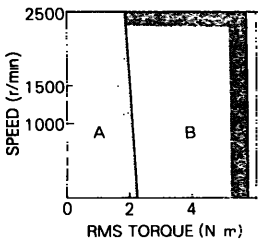

### • TYPE USAFED-20F

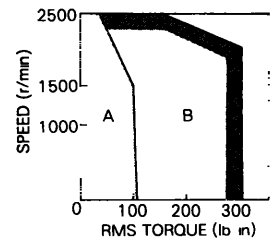
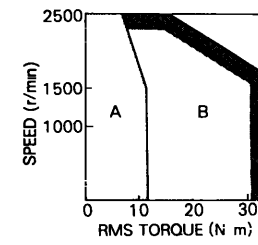

### • TYPE USAFED-05F

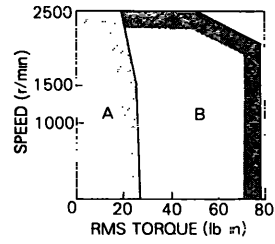
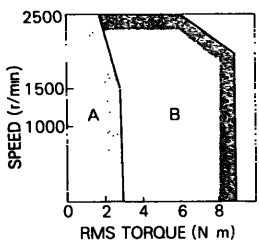

### • TYPE USAFED-30F

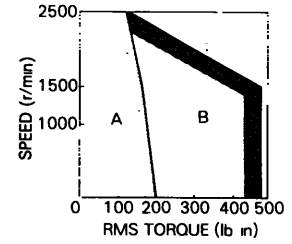
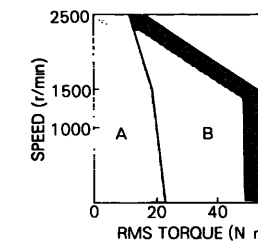

### • TYPE USAFED-09F

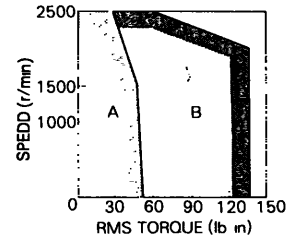
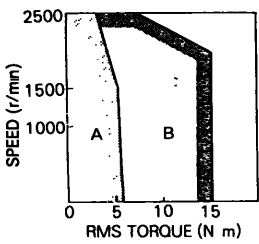

### • TYPE USAFED-44F

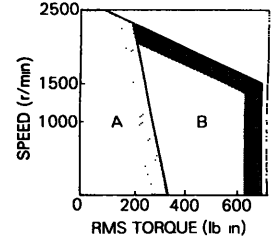
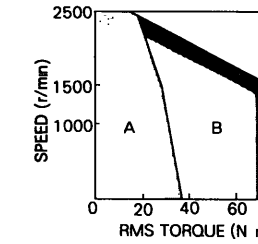

A CONTINUOUS DUTY ZONE  
B INTERMITTENT DUTY ZONE  
POWER SUPPLY 200V



### 1.3 RATINGS AND SPECIFICATIONS OF S SERIES AC SERVOMOTORS

#### 1.3.1 Ratings

Time Rating Continuous

Insulation Class B (Types USASEM-02AS2, -03AS2, -05AS2)

Class F (Types USASEM-08AS1, -15AS1, -30AS1)

Isolation Voltage 1500 VAC, one minute

Insulation Resistance 500 VDC, 10MΩ or more

Enclosure Totally-enclosed, self-cooled

Ambient Temperature 0 to +40°C

Ambient Humidity 20% to 80% (non-condensing)

Vibration 15 μm or below

Finish in Munsell Notation N1.5

Excitation Permanent magnet

Mounting Flange mounted

Drive Method Direct drive

Table 1.3 Ratings and Specifications of S Series AC Servomotors

Item	Motor Type USASEM-	02AS2	03AS2	05AS2	08AS1	15AS1	30AS1
Rated Output*	W (HP)	154 (0.2)	308 (0.4)	462 (0.6)	771 (1.1)	1540 (2.1)	3080 (4.2)
Rated Torque*	N·m (lb·in)	0.49 (4.3)	0.98 (8.7)	1.47 (13)	2.45 (22)	4.90 (43)	9.80 (87)
Continuous Max Torque*	N·m (lb·in)	0.57 (5.0)	1.18 (10)	1.67 (15)	3.33 (30)	6.17 (55)	12.2 (108)
Instantaneous Peak Torque*	N·m (lb·in)	1.47 (13)	2.94 (26)	4.02 (36)	7.35 (65)	13.7 (122)	29.0 (257)
Rated Current*	A	2.1	3.0	4.2	5.3	10.4	19.9
Rated Speed*	r/min	3000					
Instantaneous Max Speed*	r/min	4000					
Torque Constant*	N·m/A (lb·in/A)	0.247 (2.19)	0.35 (3.10)	0.37 (3.25)	0.51 (4.49)	0.50 (4.43)	0.524 (4.64)
Moment of Inertia <sup>†</sup> J <sub>M</sub> (=GD <sup>2</sup> /4)	kg·cm <sup>2</sup> (lb·in·s <sup>2</sup> ×10 <sup>-3</sup> )	0.13 (0.11)	0.51 (0.45)	7.56 (0.67)	2.85 (2.53)	3.26 (2.88)	5.75 (5.09)
Power Rate*	kW/s	18.5	18.9	28.9	21	74	167
Inertia Time Constant*	ms	1.8	2.2	1.8	1.9	0.7	0.4
Inductive Time Constant*	ms	1.5	2.7	3.1	6.2	13	26
Insulation		Class B			Class F		

\*Values when servomotor is combined with Servopack and the armature winding temperature is 100°C. Shown are normal (TYP) values above.

<sup>†</sup>Values when servomotor is combined with Servopack and the armature winding temperature is 20°C. Shown are normal (TYP) values above.

# 1 3 2 Torque-Speed Characteristics

## • TYPE USASEM-02A

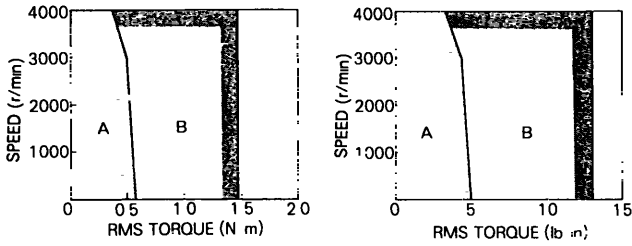

## • TYPE USASEM-08A

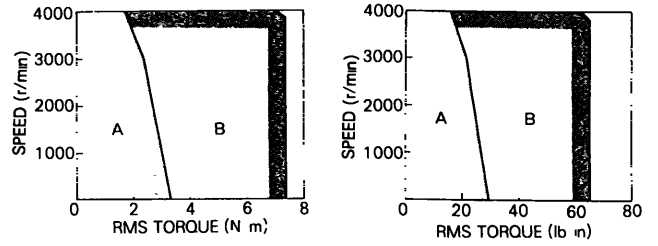

## • TYPE USASEM-03A

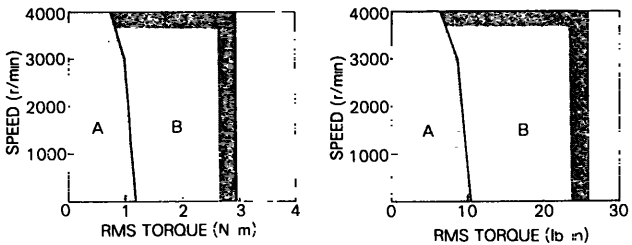

## • TYPE USASEM-15A

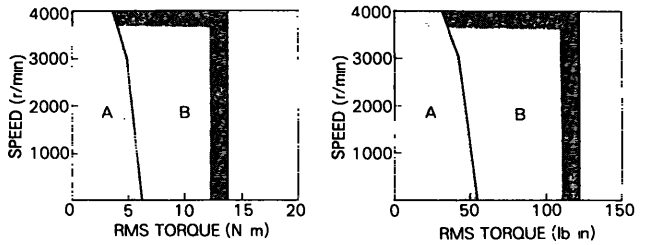

## • TYPE USASEM-05A

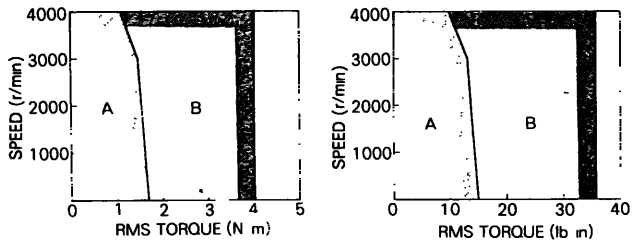

## • TYPE USASEM-30A

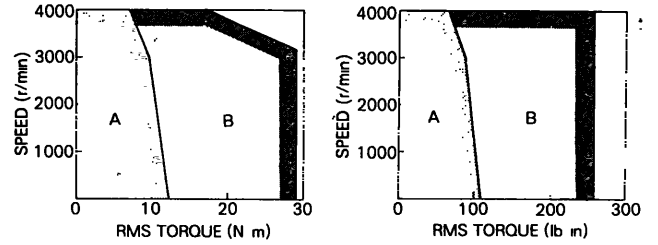

A CONTINUOUS DUTY ZONE  
 B INTERMITTENT DUTY ZONE  
 POWER SUPPLY 200V

# 1. 4 RATINGS AND SPECIFICATIONS OF D SERIES AC SERVOMOTORS

## 1 4 1 Ratings

Time Rating	Continuous	Vibration	15 $\mu$ m or below
Insulation	Class F	Finish in Munsell Notation	N1.5
Isolation Voltage	1500 VAC, one minute	Excitation	Permanent magnet
Insulation Resistance	: 500 VDC, 10M $\Omega$ or more	Mounting	Flange mounted
Enclosure	Torally-enclosed, self-cooled	Drive Method	Direct drive
Ambient Temperature	0 to +40 C	Holding Brake	Provided
Ambient Humidity	20% to 80% (non-condensing)		

Table 1 4 Ratings and Specifications of D Series AC Servomotors

Motor Type USADED-		05ES	10ES	15ES	22ES	37ES
Rated Output*	kW (HP)	0.5 (0.67)	1.0 (1.3)	1.5 (2.0)	2.2 (2.9)	3.7 (4.9)
Rated Torque*	N·m (lb·in)	2.4 (21)	4.8 (43)	7.2 (63)	10.5 (93)	17.7 (156)
Continuous Max Torque*	N·m (lb·in)	3.4 (30)	6.4 (56)	8.8 (78)	13.7 (122)	21.6 (191)
Instantaneous Peak Torque*	N·m (lb·in)	8.2 (73)	16.9 (149)	25.1 (222)	36.8 (326)	61.8 (547)
Rated Current*	A	3.5	7.9	12.6	16.6	23.3
Rated Speed*	r/min	2000				
Instantaneous Peak Speed*	r/min	2500				
Torque Constant	N·m/A (lb·in/A)	0.83 (7.38)	0.69 (6.07)	0.64 (5.64)	0.71 (6.25)	0.82 (7.29)
Moment of Inertia $J_m (=GD^2/4)$	kg·cm <sup>2</sup> (lb·in·s <sup>2</sup> ×10 <sup>-9</sup> )	21, 13 <sup>+</sup> (18.6, 11.5 <sup>+</sup> )	32, 24 <sup>+</sup> (28.3, 21.2 <sup>+</sup> )	62, 59 <sup>+</sup> (54.9, 52.2 <sup>+</sup> )	83, 80 <sup>+</sup> (73.5, 70.8 <sup>+</sup> )	148, 145 <sup>+</sup> (131, 128.3 <sup>+</sup> )
Power Rate*	kW/s	2.7 4.4 <sup>+</sup>	7.3 9.7 <sup>+</sup>	8.2 8.6 <sup>+</sup>	13 14 <sup>+</sup>	21 22 <sup>+</sup>
Inertia Time Constant	ms	18 11 <sup>+</sup>	7.8 5.9 <sup>+</sup>	7.1 6.8 <sup>+</sup>	6.2 6.0 <sup>+</sup>	4.3 4.2 <sup>+</sup>
Inductive Time Constant	ms	4.4	6.9	9.4	11	15
Insulation		Class F				
Holding Brake	Power Supply VDC	90				
	Static Friction Torque N·m (lb·in)	8.8 (78)			21.6 (191)	
Approx Weight	kg (lb)	17, 16 <sup>+</sup> (37.5, 35.3 <sup>+</sup> )	19, 18 <sup>+</sup> (41.9, 39.7 <sup>+</sup> )	30, 27 <sup>+</sup> (66.2, 59.5 <sup>+</sup> )	32, 29 <sup>+</sup> (70.6, 64 <sup>+</sup> )	39, 36 <sup>+</sup> (86.0, 79.4 <sup>+</sup> )

\*Values when servomotor is combined with Servopack and the armature winding temperature is 20°C. Shown are normal (TYF) values above.  
<sup>+</sup>Values show those of D series without holding brake.

Brake power supply specifications 2 types  
 • Input 100VAC Output 90VDC, OPR109F Type  
 • Input 200VAC Output 90VDC, OPR109A Type  
 For details, refer to Par 6.9.3

## 1 4 2 Torque-Speed Characteristics

### • USADED-05E

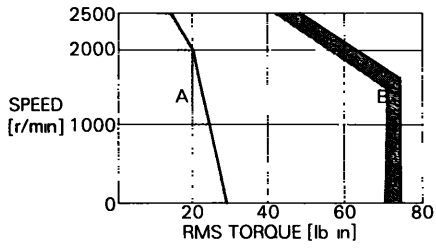

### • USADED-10E

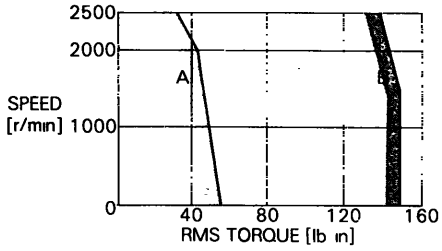

### • USADED-15E

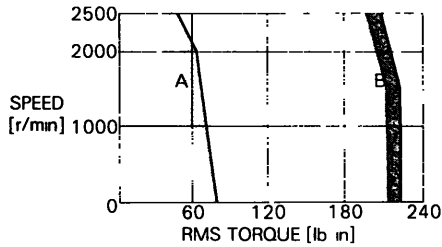

### • USADED-22E

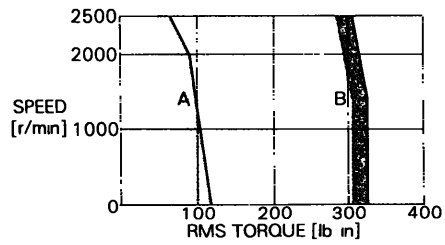

### • USADED-37E

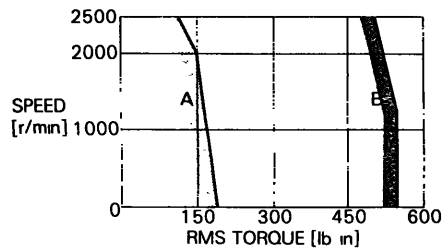

A Continuous Duty Zone  
B Intermittent Duty Zone

### • USADED-05E

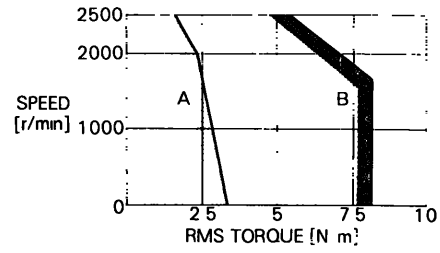

### • USADED-10E

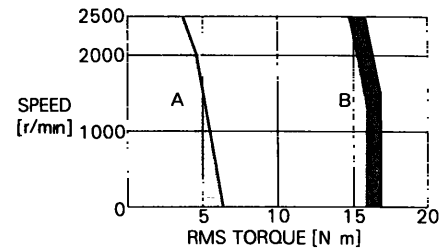

### • USADED-15E

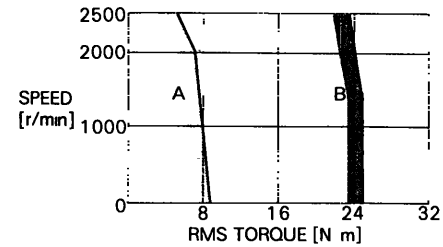

### USADED-

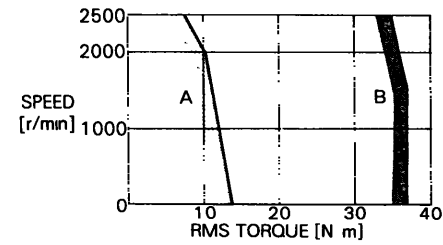

### • USADED-37E

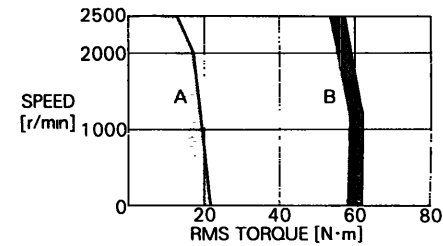

A Continuous Duty Zone  
B Intermittent Duty Zone

# 1.5 RATINGS AND SPECIFICATIONS OF *Servopack*

Table 1. 5 Ratings and Specifications of *Servopack*

Servopack Type CACR-		SR03BB	SR05BB	SR07BB	SR10BB	SR15BB	SR20BB	SR30BB	SR44BB	SR60BB	
Max Motor Output	kW (HP)	0 3 (0 4)	0 5 (0 67)	0 7 (0 94)	1 0 (1 34)	1 5 (2 01)	2 0 (2 7)	3 0 (4 1)	4 4 (6 0)	6 0 (8 2)	
	Applicable Optical Encoder	A 6000 P/R (B 5000 P/R, D 4000 P/R)									
M Series AC Servomotor	Type USAMED-	03MA	-	06MA	09MA	12MA	20MA	30MA	44MA	60MA*1	
	Output kW (HP)	0 3 (0 4)	-	0 6 (0 8)	0 9 (1 2)	1 2 (1 6)	2 0 (2 7)	3 0 (4 1)	4 4 (6 0)	6 0 (8 2)	
	Rated Speed r/min	1000									
Servopack Type CACR-		03BB1AM	-	SR07BB1AM	SR10BB1AM	SR15BB1AM	SR20BB1AM	SR30BB1AM	SR44BB1AM	SR60BB1AM	
Continuous Output Current	Arms	3 0	-	5 8	7 6	11 7	18 8	26 0	33 0	45 0	
Max Output Current	Arms	7 3	-	13 9	16 6	28 0	42 0	56 5	70 0	80 6	
Allowable J <sub>L</sub> (=GD <sup>2</sup> /4)	kg·cm <sup>2</sup> (lb in s <sup>2</sup> ×10 <sup>-3</sup> )	67 5 (60)	-	121 5 (107 5)	183 5 (162 5)	334 (296)	550 (486)	715 (633 5)	1200 (1063)	1200 (1063)	
Applicable Optical Encoder		A 6000 P/R (B 5000 P/R, D 4000 P/R)									
F Series AC Servomotor	Type USAFED-	02FA	03FA	05FA	-	09FA	13FA	20FA	30FA	44FA	-
	Output kW (HP)	0 15 (0 2)	0 3 (0 4)	0 45 (0 6)	-	0 85 (1 2)	1 3 (1 8)	1 8 (2 4)	2 9 (3 9)	4 4 (6 0)	-
	Rated Speed r/min	1500									
Servopack Type CACR-		SR03BB1AF	SR05BB1AF	-	SR10BB1AF	SR15BB1AF	SR20BB1AF	SR30BB1AF	SR44BB1AF	-	
Continuous Output Current	Arms	3 0	3 0	3 8	-	6 2	9 7	15 0	20 0	30 0	-
Max Output Current	Arms	8 5	8 5	11 0	-	17 0	27 6	42 0	56 5	77 0	-
Allowable J <sub>L</sub> (=GD <sup>2</sup> /4)	kg·cm <sup>2</sup> (lb in s <sup>2</sup> ×10 <sup>-3</sup> )	6 5 (5 75)	10 3 (9)	67 5 (60)	-	121 5 (107 5)	183 5 (162 5)	334 (296)	550 (486)	715 (633 5)	-
Applicable Optical Encoder		C 2500 pulses (E 1500 P/R, F 1000 P/R)									
S Series AC Servomotor	Type USASEM-	02AE	03AE	05AE	-	08AC	15AC	-	30AC	-	-
	Output kW (HP)	0 15 (0 2)	0 3 (0 4)	0 46 (0 6)	-	0 77 (1 1)	1 54 (2 1)	-	3 08 (4 2)	-	-
	Rated Speed r/min	3000									
Servopack Type CACR-		SR03BB-ES v41	SR05BB1ES	-	SR10BB1CS	SR15BB1CS	-	SR30BB1CS	-	-	
Continuous Output Current	Arms	2 1	3 0	4 3	-	5 3	10 4	-	19 9	-	
Max Output Current	Arms	6 0	8 5	11 0	-	15 6	28 0	-	56 5	-	
Allowable J <sub>L</sub> (=GD <sup>2</sup> /4)	kg·cm <sup>2</sup> (lb in s <sup>2</sup> ×10 <sup>-3</sup> )	0 65 (0 55)	2 55 (2 25)	3 75 (3 35)	-	14 25 (12 65)	16 5 (14 4)	-	28 7 (25 45)	-	
Applicable Optical Encoder		C 2500 pulses (E 1500 P/R, F 1000 P/R)									
D Series AC Servomotor	Type USADED-	-	05ES	-	-	10ES	15ES	22ES	37ES	-	
	Output kW (HP)	-	0 5 (0 67)	-	-	1 0 (1 34)	1 5 (2 01)	2 2 (2 9)	3 7 (4 9)	-	
	Rated Speed r/min	2000									
Servopack Type CACR-		-	SR05BZ1SD	-	-	SR15BZ1SD	SR20BZ1SD	SR30BZ1SD	SR44BZ1SD	-	
Continuous Output Current	Arms	-	3 5	-	-	7 9	12 6	16 6	23 3	-	
Max Output Current	Arms	-	10 6	-	-	24 2	40 7	54 0	77 0	-	
Allowable J <sub>L</sub> (=GD <sup>2</sup> /4)	kg·cm <sup>2</sup> (lb in s <sup>2</sup> ×10 <sup>-3</sup> )	-	105 (91)	-	-	160 (143)	310 (273 5)	415 (369)	755 (655)	-	

# 1.5 RATINGS AND SPECIFICATIONS OF *Servopack* (Cont'd)

Table 1 5 Ratings and Specifications of *Servopack* (Cont'd)

<b>Servopack</b>	Power Supply	Main Circuit	Three-phase 200 to 230 VAC $\pm 10\%$ / $-15\%$ 50/60 Hz *2								
		Control Circuit	Single-phase 200 to 230 VAC $\pm 10\%$ / $-15\%$ 50/60 Hz								
	Basic Specifications	Control Method		Transistorized PWM Control							
		Feedback		Optical encoder (A 6000 P/R, B 5000 P/R, C 2500 P/R, D 4000 P/R, E 1500 P/R, F 1000 P/R)							
		Ambient Temperature		0 to 55°C *3							
		Storage Temperature		-20°C to +85°C							
		Ambient and Storage Humidity		90% or less (non-condensing)							
		Mounting Structure		Base mounted							
		Approx Weight	kg (lb)	5.5 (13)	5.5 (13)	5.5 (13)	5.5 (13)	5.5 (13)	9.5 (21)	9.5 (21)	11 (24)
	Speed Control	Speed Control Range *4		1 3000							
		Speed Regulation *5	Load Regulation 0 to 100%	+0.03% or less at rated r/min, $\pm 0.015\%$ or less at $\frac{1}{3}$ r/min							
			Voltage Regulation $\pm 10\%$	$\pm 0.1\%$ or less at rated r/min $\pm 0.05\%$ or less at $\frac{1}{3}$ r/min							
			Temp Regulation 25 $\pm$ 25°C	$\pm 0.5\%$ or less at rated r/min $\pm 0.2\%$ or less at $\frac{1}{3}$ r/min							
	Signal I/O	Frequency Response Characteristics		100 Hz (J <sub>L</sub> = J <sub>M</sub> )							
		Speed Reference Input	Rated Reference Voltage	$\pm 6$ VDC at rated rpm (forward run at plus reference)							
			Input Impedance	Approx 12k $\Omega$							
			Circuit Time Constant	Approx 75 $\mu$ s							
		Auxiliary Reference Input *6	Reference Voltage	$\pm 2$ to $\pm 10$ VDC at rated r/min (forward run at plus reference)							
			Input Impedance	Approx 5 to 7 k $\Omega$							
			Circuit Time Constant	Approx 22 $\mu$ s or less							
		Torque Limit Input		$\pm 3$ VDC $\pm 10\%$ at $\pm 100\%$ torque							
		Built-in Reference Power Supply		$\pm 12$ VDC $\pm 5\%$ , $\pm 30$ mA							
		Input Signal		Servo ON, P drive, F run stop, R run stop, ext current limit							
	Output Signal		Servo ready, TG ON, current limit, servo alarm, overload, MCCB trip								
	Positioning Signal Output		1/N time (N = 1 to 64) of PG pulses or 2/N time (N = 2 to 64)								
	Built-in Functions	Protection		Overvoltage, overload, overcurrent, overspeed, overrun, open phase detection, MCCB trip, heatsink overheat, undervoltage, AD error, regeneration trouble, CPU error							
		Indication		Power supply, reference input, alarm, status indications							
		Dynamic Brake		Built-in (non-contact dynamic brake)							
Regenerative Resistor		Built-in							Separately installed		
Applicable Load Inertia *7		Up to 5 times motor inertia									
Monitor Output		Torque monitor 3.0 V $\pm 10\%$ at rated r/min Speed monitor 4.0 V $\pm 5\%$ at 1000 r/min (M, F, D series), 2.0 V $\pm 5\%$ at 1000 r/min (S series)									

\*1 AC servomotor type USAMKD-60MA due to externally fan-cooled  
 \*2 Supply voltage should not exceed 230 V +10% (253 V) If the voltage should exceed this value a step down transformer is required  
 \*3 When housed in a panel the inside temperature must not exceed ambient temperature range  
 \*4 In the speed control range, the lowest speed is defined as the condition in which there is 100% load variation but not stopped

\*5 Speed regulation is generally defined as follows  

$$\text{Speed regulation} = \frac{\text{No load speed} - \text{Rated speed}}{\text{Rated speed}} \times 100 (\%)$$
 Motor speed may be changed by voltage variation or operational amplifier drift due to temperature The ratio of this speed change to the rated speed represents the speed regulation due to voltage or temperature change  
 \*6 Used for application at rated reference voltage other than  $\pm 6$  V  
 \*7 When load J<sub>L</sub> exceeds applicable range, be sure to refer to 6.7.2 Load Inertia

## 2. TYPE DESIGNATION

### • AC Servomotor

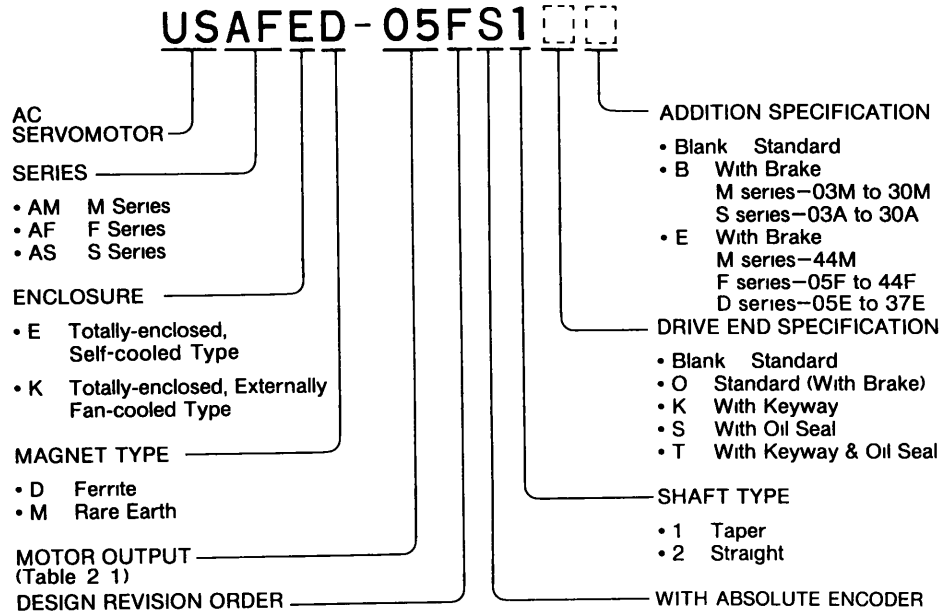

### • Servopack

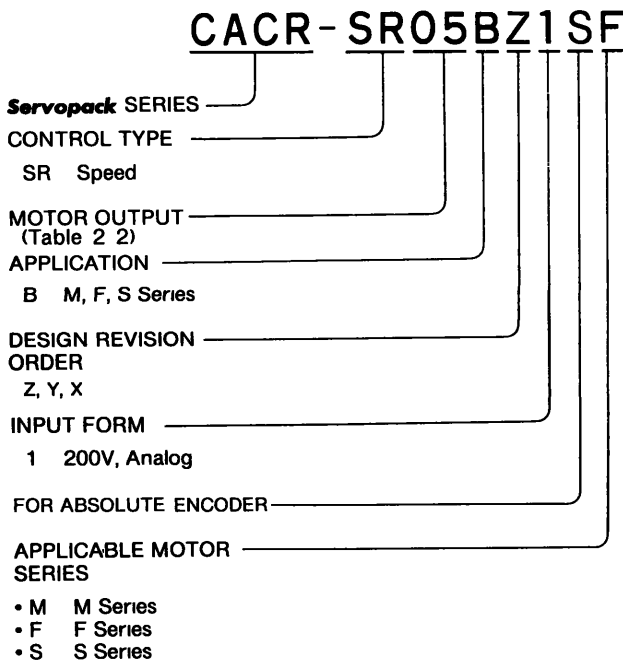

Table 2 1

	Motor Output			
	M Series	F Series	S Series	D Series
02	—	0 15kW(0 2HP)	154W(0 2HP)	—
03	0 3kW(0 4HP)	0 3kW(0 4HP)	308W(0 4HP)	—
05	—	0 45kW(0 6HP)	462W(0 6HP)	0 5kW(0 7HP)
06	0 6kW(0 8HP)	—	—	—
08	—	—	771W(1 1HP)	—
09	0 9kW(1 2HP)	0 85kW(1 2HP)	—	—
10	—	—	—	1 0kW(1 3HP)
12	1 2kW(1 6HP)	—	—	—
13	—	1 3kW(1 8HP)	—	—
15	—	—	1540W(2 1HP)	1 5kW(2 1HP)
20	2 0kW(2 7HP)	1 8kW(2 4HP)	—	—
22	—	—	—	2 2kW(2 9HP)
30	3 0kW(4 1HP)	2 9kW(3 9HP)	3080W(4 2HP)	—
37	—	—	—	3 7kW(5 0HP)
44	4 4kW(6 0HP)	4 4kW(6 0HP)	—	—
60	6 0kW(8 2HP)	—	—	—



Table 2 2

	Motor Output			
	M Series	F Series	S Series	D Series
03	0 3kW(0 4HP)	0 15kW(0 2HP) 0 3kW(0 4HP)	154W(0 2HP) 308W(0 4HP)	—
05	—	0 45kW(0 6HP)	462W(0 6HP)	0 5kW(0 7HP)
07	0 6kW(0 8HP)	—	—	—
10	0 9kW(1 2HP)	0 85kW(1 2HP)	771W(1 1HP)	—
15	1 2kW(1 6HP)	1 3kW(1 8HP)	1540W(2 1HP)	1 0kW(1 3HP)
20	2 0kW(2 7HP)	1 8kW(2 4HP)	—	1 5kW(2 1HP)
30	3 0kW(4 1HP)	2 9kW(3 9HP)	3080W(4 2HP)	2 2kW(2 9HP)
44	4 4kW(6 0HP)	4 4kW(6 0HP)	—	3 7kW(5 0HP)
60	6 0kW(8 2HP)	—	—	—



### 3. LIST OF STANDARD COMBINATION

Table 3 1 Combination of **Servopack**, AC Servomotors and Associate Units



• M SERIES

Servom Type CACR-	AC Servomotor	Power Capacity* per Servopack kVA	Current Capacity per MCCB or Fuse A	Applicable Noise Filter	Recommended Noise Filter		Power ON/OFF Switch
	Type				Type	Specifications	
SR03BZ1SM	UASMED-03MS1	0.65	5	 Good	LF-305	3-phase 200 VAC class, 5 A	Yaskawa type HI-15E <sub>2</sub> rated 30 A or equivalent
SR07BZ1SM	USAMED-06MS1	1.5	8		LF-310	3-phase 200 VAC class, 10 A	
SR10BZ1SM	USAMED-09MS2	2.1	8		LF-315	3-phase 200 VAC class, 15 A	
SR15BZ1SM	USAMED-12MS2	3.1	10		LF-315	3-phase 200 VAC class, 15 A	
SR20BZ1SM	USAMED-20MS2	4.1	12	 Poor	LF-320	3-phase 200 VAC class, 20 A	Yaskawa type HI-18E rated 35 A or equivalent
SR30BZ1SM	USAMED-30MS2	6.0	18		LF-330	3-phase 200 VAC class, 30 A	
SR44BZ1SM	USAMED-44MS2	8.0	24		LF-340	3-phase 200 VAC class, 40 A	
SR60BZ1SM	USAMKD-60MS2	11	32		LF-350	3-phase 200 VAC class, 50 A	

• F SERIES

SR03BZ1SF	USAFED-02FS1-03FS1	0.65	5	 Good	LF-305	3-phase 200 VAC class, 5 A	Yaskawa type HI-15E <sub>2</sub> rated 30 A or equivalent
SR05BZ1SF	USAFED-05FS1	1.1	5		LF-305	3-phase 200 VAC class, 5 A	
SR10BZ1SF	USAFED-09FS1	2.1	8		LF-315	3-phase 200 VAC class, 15 A	
SR15BZ1SF	USAFED-13FS2	3.1	10		LF-315	3-phase 200 VAC class, 15 A	
SR20BZ1SF	USAFED-20FS2	4.1	12	 Poor	LF-320	3-phase 200 VAC class, 20 A	Yaskawa type HI-18E rated 35 A or equivalent
SR30BZ1SF	USAFED-30FS2	6.0	18		LF-330	3-phase 200 VAC class, 30 A	
SR44BZ1SF	USAFED-44FS2	8.0	24		LF-340	3-phase 200 VAC class, 40 A	

• S SERIES

SR03BZ1SS-Y41	USASEM-02AS2	0.65	5	 Good	LF-305	3-phase 200 VAC class, 5 A	Yaskawa type HI-15E <sub>2</sub> rated 30 A or equivalent
SR03BZ1SS	USASEM-03AS2	0.65	5		LF-305	3-phase 200 VAC class, 5 A	
SR05BZ1SS	USASEM-05AS2	1.1	5		LF-305	3-phase 200 VAC class, 5 A	
SR10BZ1SS	USASEM-08AS1	2.1	8	 Poor	LF-315	3-phase 200 VAC class, 15 A	Yaskawa type HI-18E rated 35 A or equivalent
SR15BZ1SS	USASEM-15AS1	3.1	10		LF-315	3-phase 200 VAC class, 15 A	
SR30BZ1SS	USASEM-30AS1	6.0	18		LF-330	3-phase 200 VAC class, 30 A	

• D SERIES



SR05BZ1SD	USADED-05FS2	1.1	5	 Good	LF-305	3-phase 200 VAC class, 5 A	Yaskawa type HI-15E <sub>2</sub> rated 30 A or equivalent
SR15BZ1SD	USADED-10ES2	3.1	10		LF-315	3-phase 200 VAC class, 15 A	
SR20BZ1SD	USADED-15FS2	4.1	12	 Poor	LF-320	3-phase 200 VAC class, 20 A	Yaskawa type HI-18E <sub>2</sub> rated 35 A or equivalent
SR30BZ1SD	USADED-22ES2	6.0	18		LF-330	3-phase 200 VAC class, 30 A	
SR44BZ1SD	USADED-37ES2	8.0	24		LF-340	3-phase 200 VAC class, 40 A	



Table 3 2 Specifications of AC Servomotors, Detectors and Holding Brakes

• M SERIES

Servopack Type CACR-	AC Servomotor					Detector			
	Type	Receptacle Type	L-type Plug	Straight Plug	Cable Clamp	Receptacle Type	L-type Plug	Straight Plug	Cable Clamp
SR03BZ1SM	USAMED-03MS	MS3102A 18-10P	MS3108B 18-10S	MS3106B 18-10S	MS3057 -10A	MS3102A 20-29P	MS3108B 20-29S	MS3106B 20-29S	MS3057 -12A
SR07BZ1SM	USAMED-06MS								
SR10BZ1SM	USAMED-09MS								
SR15BZ1SM	USAMED-12MS	MS3102A 22-22P	MS3108B 22-22S	MS3106B 22-22S	MS3057 -12A				
SR20BZ1SM	USAMED-20MS								
SR30BZ1SM	USAMED-30MS	MS3102A 32-17P	MS3108B 32-17S	MS3106B 32-17S	MS3057 -20A				
SR44BZ1SM	USAMED-44MS								
SR60BZ1SM	USAMKD-60MS								

• F SERIES

SR03BZ1SF	USAFED-02FS	MS3102A 14S-2P	MS3108B 14S-2S	MS3106B 14S-2S	MS3057 -6A	MS3102A 20-29P	MS3108B 20-29S	MS3106B 20-29S	MS3057 -12A
	USAFED-03FS								
SR05BZ1SF	USAFED-05FS	MS3102A 18-10S	MS3108B 18-10S	MS3106B 18-10S	MS3057 -10A				
SR10BZ1SF	USAFED-09FS								
SR15BZ1SF	USAFED-13FS								
SR20BZ1SF	USAFED-20FS	MS3102A 22-22P	MS3108B 22-22S	MS3106B 22-22S	MS3057 -12A				
SR30BZ1SF	USAFED-30FS								
SR44BZ1SF	USAFED-44FS								

• S SERIES

SR03BZ1SS-Y41	USASEM-02AS	MS3102A 18-10P	MS3108B 18-10S	—	MS3057 -10A	MS3102A 20-29P	—	MS3108B 20-29S	MS3057 -12A
SR03BZ1SS	USASEM-03AS								
SR05BZ1SS	USASEM-05AS								
SR10BZ1SS	USASEM-08AS	MS3102A 20-4P	MS3108B 20-4S	—	MS3057 -12A				
SR15BZ1SS	USASEM-15AS								
SR30BZ1SS	USASEM-30AS								

• D SERIES

SR05BZ1SD	USADED-05ES	MS3102A 20-15P	MS3108B 20-15S	MS3106B 20-15S	MS3057 -12A	MS3102A 20-29P	MS308B 20-29S	MS3106B 20-S29S	MS3057 -12A
SR15BZ1SD	USADED-10ES								
SR20BZ1SD	USADED-15ES	MS3102A 24-10P	MS3108B 24-10S	MS3106B 24-10S	MS3057 -16A				
SR30BZ1SD	USADED-22ES								
SR44BZ1SD	USADED-37ES								

Note

1 Drawout construction of Type USASEM-02AE20B is waterproof gland method For details, contact your Yaskawa representative

2 When plugs or clamps are required, contact Yaskawa representative The following connections are provided soldered type (type MS) and solderless type (type JA)

### 3. LIST OF STANDARD COMBINATION(Cont'd)

Table 3 3 Specifications of Holding Brake

• M SERIES

Servopack Type CACR-	AC Servomotor Type	Holding Brake			
		Receptacle Type	L-type Plug	Straigt Plug	Cable Clamp
SR03BZ1SM	USAMED-03MS				
SR07BZ1SM	USAMED-06MS	MS3102 20-15P	MS3108B 20-15S	MS3106B 20-15S	MS3057-12A
SR10BZ1SM	USAMED-09MS				
SR15BZ1SM	USAMED-12MS				
SR20BZ1SM	USAMED-20MS	MS3102A 24-10P	MS3108B 24-10S	MS3106B 24-10S	MS3057-16A
SR30BZ1SM	USAMED-30MS				
SR44BZ1SM	USAMED-44MS	-	-	-	-
SR60BZ1SM	USAMED-60MS				

• F SERIES

SR03BZ1SF	USAFED-02FS	MS3102A 14S-6P	MS3188A 14S-6S	MS3106B 14S-6S	MS3057-6A
	USAFED-03FS				
SR05BZ1SF	USEFAD-05FS				
SR10BZ1SF	USAFED-09FS	MS3102A 20-15P	MS3108B 20-15S	MS3106B 20-15S	MS3057-12A
SR15BZ1SF	USAFED-13FS				
SR20BZ1SF	USAFED-20FS				
SR30BZ1SF	USAFED-30FS	MS3102A 24-10P	MS3108B 24-10S	MS3106B 24-10S	MS3057-16A
SR44BZ1SF	USAFED-44FS				

• S SERIES

SR03BZ1SS-Y41	USASEM-02AS				
SR03BZ1SS	USASEM-03AS	MS3102A 18-12P	MS3108B 18-12S		MS3057-10A
SR05BZ1SS	USASEM-05AS				
SR10BZ1SS	USASEM-08AS				
SR15BZ1SS	USASEM-15AS	MS3102A 20-17P	MS3108B 20-17S		MS3057-12A
SR30BZ1SS	USASEM-30AS				

## 4. CHARACTERISTICS

### 4.1 OVERLOAD CHARACTERISTICS

The overload protective circuit built in Servopack prevents the motor and Servopack from overload and restricts the allowable conduction time of Servopack. (See Fig. 4.1.)

The overload detection level is set precisely by the hot start conditions at an ambient temperature of 55°C and cannot be changed.

#### NOTE

Hot start is the overload characteristics when the Servopack is running at the rated load and thermally saturated

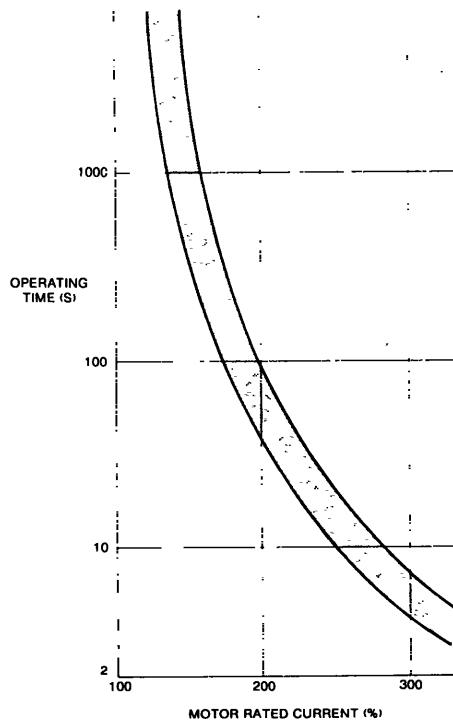

Fig 4 1 Allowable Conduction Current of **Servopack**

### 4.2 STARTING AND STOPPING TIME

The starting time and stopping time of servomotor under a constant load is shown by the formula below. Viscous or friction torque of the motor is neglected.

Starting Time:

$$t_r = 104.7 \times \frac{NR (J_M + J_L)}{Kt I_R (\alpha - \beta)} \text{ (ms)}$$

Stopping Time:

$$t_f = 104.7 \times \frac{NR (J_M + J_L)}{Kt I_R (\alpha + \beta)} \text{ (ms)}$$

Where,

$N_R$  : Rated motor speed (r/min)

$J_M (= GD_M^2/4)$  : Moment of rotor inertia  
( $\text{kg} \cdot \text{cm}^2 = \text{lb} \cdot \text{in} \cdot \text{s}^2 \times 10^{-3}$ )

$J_L (= GD_L^2/4)$  : Moment of load inertia  
( $\text{kg} \cdot \text{cm}^2 = \text{lb} \cdot \text{in} \cdot \text{s}^2 \times 10^{-3}$ )

$K_t$  : Torque constant of motor ( $\text{N} \cdot \text{m}/\text{A} = \text{lb} \cdot \text{in}/\text{A}$ )

$I_R$  : Motor rated current (A)

$\alpha = I_P / I_R$  : Acceleration/deceleration current constant

$I_P$  : Acceleration/deceleration current (Acceleration/deceleration current  $\alpha$  times the motor rated current) (A)

$\beta = I_L / I_R$  : Load current constant

$I_L$  : Current equivalent to load torque (Load current  $\beta$  times the motor rated current) (A)

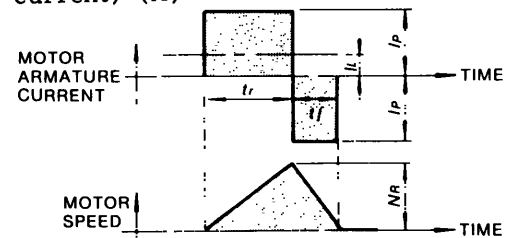

Fig 4 2 Timing Chart of Motor Armature Current and Speed

### 4.3 ALLOWABLE FREQUENCY OF OPERATION

The allowable frequency of operation is restricted by the servomotor and Servopack, and both the conditions must be considered for satisfactory operation.

- Allowable frequency of operation restricted by the **Servopack**

The allowable frequency of operation is restricted by the heat generated in the regenerative resistor in the Servopack, and varies depending on the motor types, capacity, load  $J$  ( $J_L$ ), acceleration/deceleration current values, and motor speed. If the frequency of operation exceeds 60 times/min when load  $J = 0$  before the rated speed is reached, or if it exceeds  $\frac{60}{m+1}$  cycles/min when  $J_L = J_M \times m$ , contact Yaskawa representative.

- Allowable frequency of operation restricted by the Servomotor

The allowable frequency of operation varies depending on the load conditions, motor running time and the operating conditions. Typical examples are shown below. See Par. 4.2 Starting and Stopping Time for symbols.

- When the motor repeats rated-speed operation and being at standstill (Fig 4 3)

Cycle time ( $T$ ) should be determined so that RMS value of motor armature current is lower than the motor rated current:

$$T \geq \frac{I_P^2 (t_r + t_f) + I_L^2 t_s}{I_R^2} \text{ (s)}$$

### 4.3 ALLOWABLE FREQUENCY OF OPERATION (Cont'd)

Where cycle time (T) is determined, values  $I_p$ ,  $t_r$ ,  $t_f$  satisfying the formula above, should be specified.

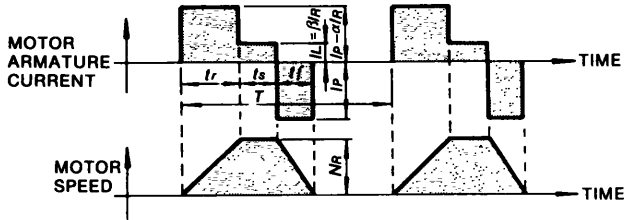

Fig 4 3 Timing Chart of Motor Armature Current and Speed

- When the motor remains at standstill between cycles of acceleration and deceleration without continuous rated speed running (Fig 4 4)

The timing chart of the motor armature current and speed is as shown in Fig.4.4. The allowable frequency of operation "n" can be calculated as follows:

$$n = 286.5 \times \frac{Kt \cdot I_r}{NR (J_M + J_L)} \times \left( \frac{1}{\alpha} - \frac{\beta^2}{\alpha^3} \right) \quad (\text{times/min})$$

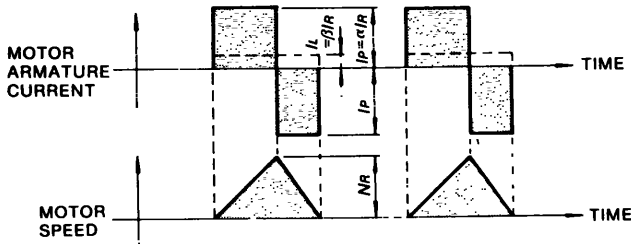

Fig 4 4 Timing Chart of Motor Armature Current and Speed

- When the motor accelerates, runs at constant speed, and decelerates in a continuing cycle without being at standstill (Fig 4 5)

The timing chart of the motor armature current and speed is as shown in Fig.4.5. The allowable frequency of operation "n" can be calculated as follows.

$$n = 286.5 \times \frac{Kt \cdot I_r}{(J_M + J_L)} \times \left( \frac{1}{\alpha} - \frac{\beta^2}{\alpha} \right) \quad (\text{times/min})$$

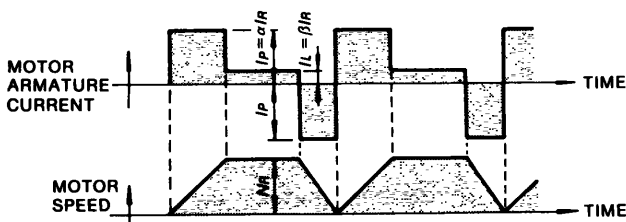

Fig 4 5 Timing Chart of Motor Armature Current and Speed

### 4.4 SERVOMOTOR FREQUENCY

In the servo drive consisting of Servopack and servomotor, motor speed amplitude is restricted by the maximum armature current controlled by Servopack.

The relation between motor speed amplitude (N) and frequency (f) is shown by the formula below:

$$N = 1.52 \times \frac{\alpha \cdot Kt \cdot I_r}{(J_M + J_L) f} \quad (\text{r/min})$$

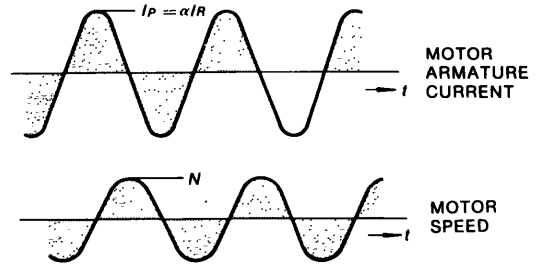

Fig 4 6 Timing Chart of Motor Armature Current and Speed

### 4.5 MOTOR SPEED - REFERENCE INPUT CHARACTERISTICS

Fig.4.7 shows motor speed and input voltage curve when speed reference input terminals 1CN-12 and 13 are used. With auxiliary input terminals, 1CN-14 and 15, motor speed can be set to the rating by adjusting IN-B potentiometer as long as input voltage is within ±2V to ±10V. See Fig. 4.8.

The forward motor rotation (+) means counterclockwise rotation when viewed from the drive end.

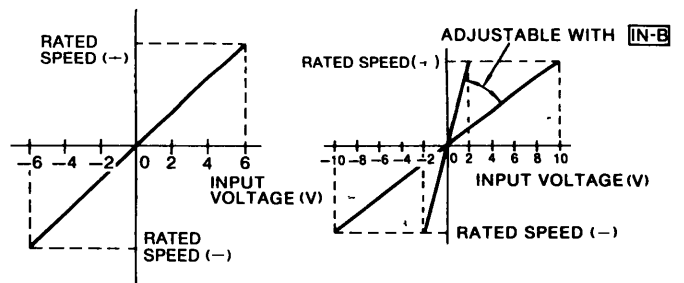

Fig 4 7 Speed-Input Voltage Characteristics

Fig 4 8 Speed-Input Voltage Characteristics when Auxiliary Input Terminals 1CN-14 and 15 are used

### 4.6 MOTOR MECHANICAL CHARACTERISTICS

#### 4 6 1 Mechanical Strength

AC servomotors can carry up to 300% of the rated momentary maximum torque at output shaft.

#### 4 6 2 Allowable Radial Load and Thrust Load

Table 4.1 shows allowable loads according to AC servomotor types.

Table 4 1 M Series Allowable Radial Load and Thrust Load

Motor Type USAMED-	Allowable Radial Load* N (lb)	Allowable Thrust Load N (lb)
03MS1	490 (110)	98 ( 22) †
06MS1	490 (110)	98 ( 22) †
09MS2	686 (154)	343 ( 77)
12MS2	1470 (330)	490 (110)
20MS2	1470 (330)	490 (110)
30MS2	1470 (330)	490 (110)
44MS2	1764 (397)	588 (132)
60MS2	1764 (397)	588 (132)

Table 4 2 F Series Allowable Radial Load and Thrust Load

Motor Type USAFED-	Allowable Radial Load* N (lb)	Allowable Thrust Load N (lb)
02FS1	147 ( 33)	49 ( 11) †
03FS1	147 ( 33)	49 ( 11) †
05FS1	490 (110)	98 ( 22) †
09FS1	490 (110)	98 ( 22) †
13FS2	686 (154)	343 ( 77)
20FS2	1470 (331)	490 (110)
30FS2	1470 (331)	490 (110)
44FS2	1470 (331)	490 (110)

Table 4 3 S Series Allowable Radial Load and Thrust Load

Motor Type USASEM-	Allowable Radial Load* N (lb)	Allowable Thrust Load N (lb)
02AS2	78.4 ( 18)	39.2 ( 9)
03AS2	245 ( 55)	98 ( 22)
05AS2	245 ( 55)	98 ( 22)
08AS1	392 ( 88)	147 ( 33)
15AS1	490 (110)	147 ( 33)
30AS1	686 (154)	196 ( 44)

Table 4 4 D Series Allowable Radial Load and Thrust Load

Motor Type USADED-	Allowable Radial Load* N (lb)	Allowable Thrust Load N (lb)
05ES	686 (154)	343 ( 77)
10ES	686 (154)	343 ( 77)
15ES	1176 (265)	490 (110)
22ES	1176 (265)	490 (110)
37ES	1176 (265)	490 (110)

\*Maximum values of the load applying to the shaft extension  
 † Do not apply the exceeding load because motor cannot be rotated

#### 4 6 3 Mechanical Specifications (M, F, S and D Series)

Table 4 5 Mechanical Specifications in mm

Accuracy (T I R) †	Reference Diagram
Flange surface perpendicular to shaft (A)	
Flange diameter concentric to shaft (B)	
Shaft run out (C)	

\*Accuracy for motor types USADED-15ES, -22ES, and -37ES  
 † T I R (Total Indicator Reading)  
 ‡ Accuracy for motor type USAMED-44MS2

#### 4 6 4 Direction of Rotation

AC servomotors rotate counterclockwise viewed from drive end when motor and detector leads are connected as shown below.

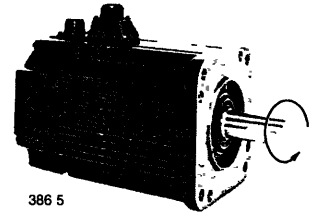
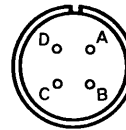

Fig 4 9 AC Servomotor

#### (1) Connector Specifications for Standard Servomotors

##### (a) Motor receptacle

• M, F Series



A	Phase U
B	Phase V
C	Phase W
D	Ground

• S Series (Type USASEM-02A)

Color of Lead	Applicable
Red	Phase U
White	Phase V
Blue	Phase W
Green	Frame ground

(Types USASEM-03A to 30A)

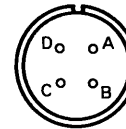

A	Phase U
B	Phase V
C	Phase W
D	Frame ground

##### (b) Detector receptacle

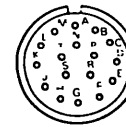

A	Channel A output	K	Channel U output
B	Channel Ā output	L	Channel Ū output
C	Channel B output	M	Channel V output
D	Channel B̄ output	N	Channel V̄ output
E	Channel Z output	P	Channel W output
F	Channel Z̄ output	R	Channel W̄ output
G	0V	S	—
H	+5VDC	T	—
J	Frame ground	—	—

#### (2) Connector Specifications for Servomotor with Brake

• M, F, D Series (Brake is provided to all types of D series as standard.)



A	Phase U	E	Brake terminal
B	Phase V	F	
C	Phase W	G	—
D	Ground	—	—

Types without brake of D series do not use E and F.

#### 4 6 4 Direction of Rotation (Cont'd)

• S Series  
(Type USASEM-02A)

Color of Lead	Applicable	Color of Lead	Applicable
Red	Phase U	Black	Brake
White	Phase V	Black	
Blue	Phase W	Green	Frame Ground

(Types USASEM-03A, -05A)

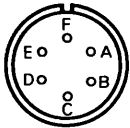

A	Phase U
B	Phase V
C	Phase W
D	Brake terminal
E	
F	Frame ground

(Types USASEM-08A to 30A)



A	Phase U
B	Phase V
C	Phase W
D	Brake terminal
E	
F	Frame ground

(3) Fan Terminal Connection  
(for only type USAMKD-60MA2)

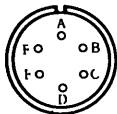

A	Fan motor
B	
C	—
D	Alarm terminal
E	
F	—

#### FAN MOTOR CONNECTOR

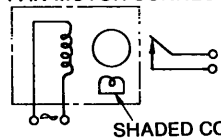

ALARM CONTACT OFF AT FAN NORMAL OPERATION  
ON AT 1800 ± 200r/min OR LESS  
ON FOR APPROX 3 SEC AT  
START  
CONTACT CAPACITY RESISTIVE LOAD MAX 110V  
0.3A

POWER SUPPLY SINGLE PHASE  
200/200/200V 50/60/60Hz

Fig 4 10 Fan Terminal Connection

The cooling fan is not of dripproof protected construction.

If the alarm for cooling fan occurs, perform the following action.

- The control circuit (provided by user) should be formed to stop the main motor and fan motor if the alarm for cooling fan occurs. (Contact is ON when alarm occurs.)

The action from alarm signal output to nonconducting state should be executed within five minutes, because the self-cooled protection of main motor lasts for five minutes.

- When the cooling fan is started, error detection signal becomes ON state for one second. Therefore, delay relay is included in the circuit.

#### 4 6 5 Impact Resistance

When mounted horizontally and exposed to vertical shock impulses, the motor can withstand up to two impacts with impact acceleration of 10G (Fig.4.11).

#### NOTE

A precision detector is mounted on the opposite-drive end of AC servomotor. Care should be taken to protect the shaft from impacts that could damage the detector.

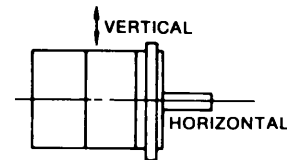

Fig 4 11 Impact Resistance

#### 4 6 6 Vibration Resistance

When mounted horizontally, the motor can withstand vibration (vertical, lateral, axial) of 2.5 G (Fig.4.12).

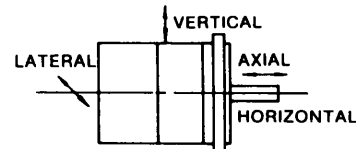

Fig 4 12 Vibration Resistance

#### 4 6 7 Vibration Class

Vibration of the motor running at rated speed is 15µm or below (Fig.4.13).

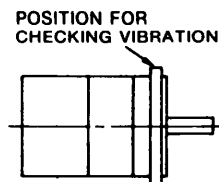

Fig 4 13 Vibration Checking

#### 4 6 8 Holding Brake

Turn on/off according to Par. 6.9.3 "Application of servopacks with Holding Magnetic Brake" since AC servo motors with brake is used when the operation is held.

# 5. CONFIGURATION

## 5.1 CONNECTION DIAGRAM

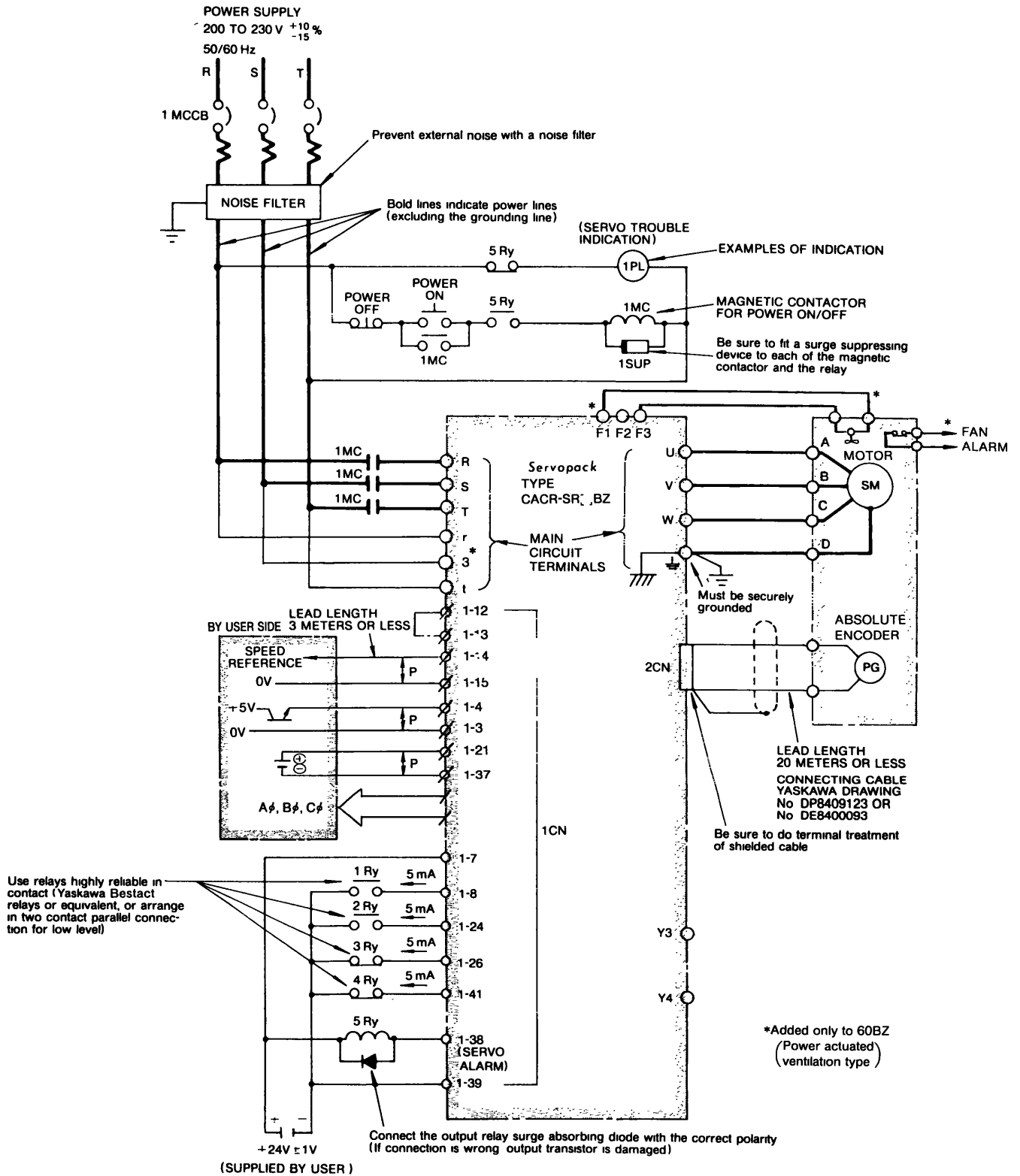

Fig 5 1 Example of Connection Diagram of Servopack with a Servomotor and Peripherals







### 5.3 EXTERNAL TERMINALS

Table 5.1 shows the specifications of external terminals for Servopack.

Table 5.1 External Terminals for Servopack

Terminal Symbol	Name	Description
Ⓜ Ⓝ Ⓣ	Main-circuit AC input	Three-phase 200 to 230 VAC $\pm 10\%$ , 50/60 Hz
Ⓤ Ⓥ Ⓦ	Motor connection	Connects terminal Ⓤ to motor terminal A, Ⓥ to B and Ⓦ to C
Ⓣ Ⓣ	Control power input	Single-phase 200 to 230 VAC $\pm 10\%$ , 50/60 Hz
Ⓧ	Ground	Connects to motor terminal D. Must be securely grounded
Ⓨ3 Ⓨ4	Regenerative resistor	External connection not usually required

### 5.4 CONNECTOR TERMINAL (1CN) FOR INPUT/OUTPUT SIGNAL

#### 5.4.1 Specifications of Applicable Receptacles

Table 5.2 Specifications of Applicable Receptacles for Servopack Input/Output Signal

Connector Type* used in Servopack	Applicable Receptacle Type			
	Manufacturer	Soldered Type	Caulking Type	Case
MR-50RMA (Right angle 50 P)	Honda Tsushin Co., Ltd	MR-50F*	MRP-50F01	MR-50L†

\*The connectors for input/output signals used are type MR-50RMA made by Honda Tsushin Co.

†Attached to Servopack when shipping

#### 5.4.2 Connector 1CN Layout and Connection of Servopack

The terminal layout of the Servopack input/output signal connectors (1CN) is shown in Table 5.3. The external connection and external signal processing are shown in Fig. 5.3 on page 22.

Table 5.3 Connector 1CN Layout of Servopack

1	2	3	4	5	6	7	8	9	10	11	12	13	14	15	16	17	18
0 V	0 V	0SEN	SEN	CLT-	CLT-	-24V IN	S-ON	TRQ-M	VTG-M	SG	IN-A	SG A	IN-B	SG B	-12V	SG	FG
0V for PG Output Signal	SEN Signal Input	Current Limit Detection Output		Ext Power input	Servo ON Power	Speed Monitor		Speed Reference Input		Auxiliary Input		+12V Output		Frame Ground			
		19	20	21	22	23	24	25	26	27	28	29	30	31	32		
		PCO	*PCO	BAT	TG ON +	TG ON -	P-CON	OL -	N-OT	S-RDY -	S-RDY +	N-CL	SG	-12V	SG		
		PG Output Signal (Phase C)		Battery ⊖	TG ON Signal Output		P Drive Input	Over oac Detecting Signal	Reverse Inhibit Input	Servo Ready Output		Reverse Current Output		-12 V Output			
33	34	35	36	37	38	39	40	41	42	43	44	45	46	47	48	49	50
PAO	*PAO	PBO	*PBO	BATO	ALM-	ALM-	OL +	P-OT	MCCB -	MCCB +	P-CL	SG	-12V	SG	+12V	SG	FG
PG Output Signal (Phase A)	PG Output Signal (Phase B)	Battery ⊖	Servo Alarm Output		Over oac Detecting Signal	Fwd Inhb Input	MCCB Trip Signal Output		Fwd Current Limit Input		12 V Output		+12 V Output		Frame Ground		
PG Output Signals				External Sequence Signals						Analog Signals							
+5V				+24V						+12V							

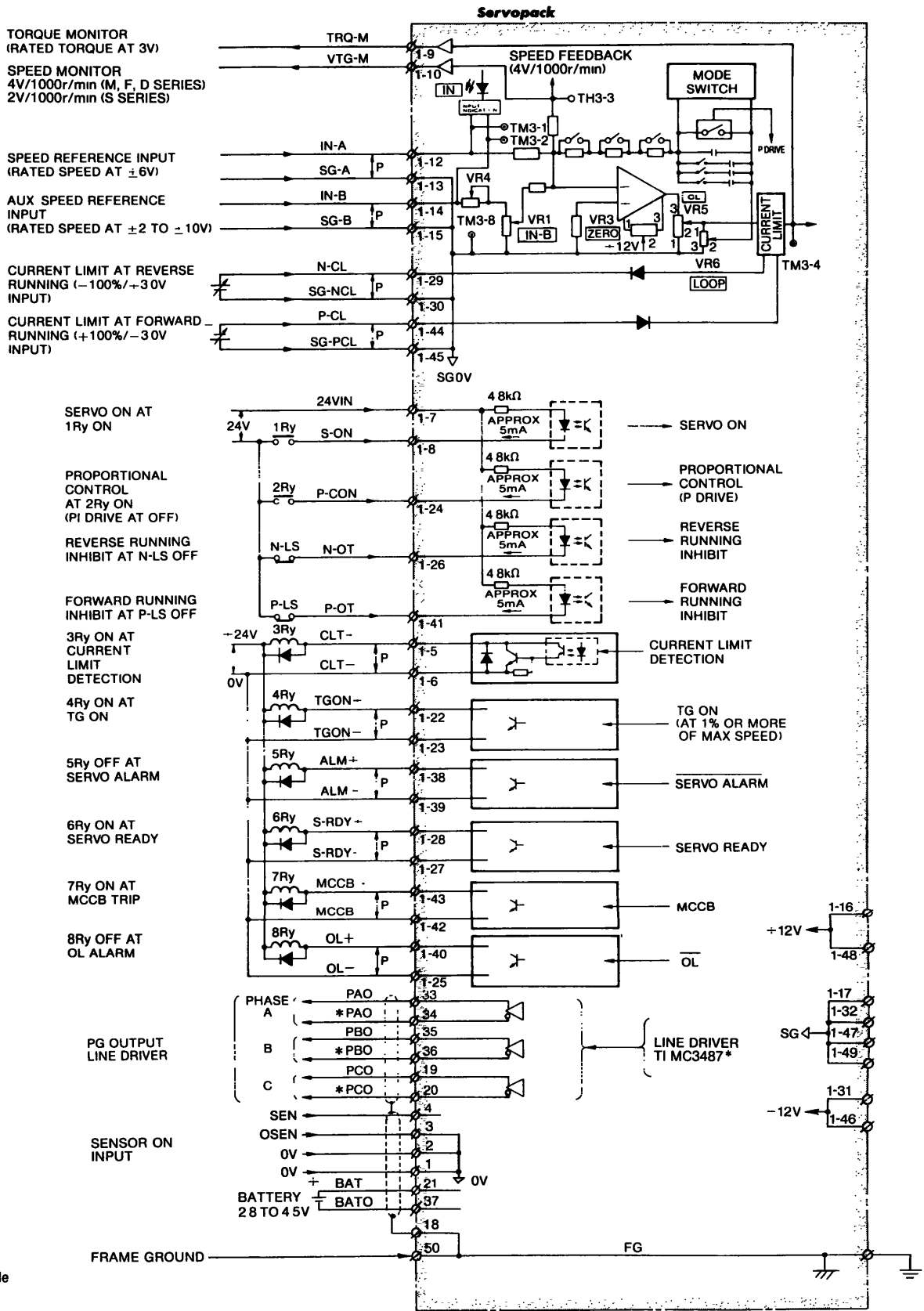

\*Made by Texas Instrument Inc

Note

- 1 Each capacity of output circuits is 30VDC, 100mA or less
- 2 The user must provide the 24V power supply and battery

Fig 5 4 Input/output of Signals and Connector 1CN

5 4 2 Connector 1CN Layout and Connection of **Servopack** (Cont'd)

Table 5 4 Input Signals of Connector 1CN

Signal Name	Connector 1CN No	Function	Description
SV-ON	1CN-8	Servo ON	Inputting this signal makes the Servopack ready to receive speed reference input ( +6 V) Base block and dynamic brake are cleared
P-CON	1CN-24	Proportional drive reference	Proportional control command applies friction torque to the motor to prevent drifting when the motor is left motionless without command input, while the main circuit is kept energized
$\overline{N-OT}$	1CN-26	Reverse running prohibit	In the case of linear drive, etc., connect limit switch signal according to the run direction. Since it is a bar signal (reverse signal), it is "closed" during normal run. When limit switch is tripped, it becomes "open"
$\overline{P-OT}$	1CN-41	Forward running prohibit	In the case of linear drive, etc., connect limit switch signal according to the run direction. Since it is a bar signal (reverse signal), it is "closed" during normal run. When limit switch is tripped, it becomes "open"
24 V	1CN-7	24 V	External power supply to 1CN-8, 24, 26 and 41. Prepare a 24VDC (20 mA min.) power supply
IN-A	1CN-12(13)	Speed command input	At $\pm 6.0$ V, $\pm$ rated speed is obtained
IN-B	1CN-14(15)	Aux command input	At $\pm 2.0$ to $\pm 10.0$ V, $\pm$ rated speed is obtained. For adjustment, potentiometer $\overline{IN-B}$ is used
N-CL	1CN-29(30)	Current limit reference at reverse running	$-3.0$ V $\pm 10\%/100\%$ torque $-9$ V max
P-CL	1CN-44(45)	Current limit reference at forward running	$3.0$ V $\pm 10\%/100\%$ torque $-9$ V max
SEN	4(3) (2) (1)	Sensor ON	If this signal is changed from low-level to high-level, after +5V is supplied to the absolute encoder, and serial data and initial pulse are output, normal output operation is performed. If this signal is changed from high-level to low-level, absolute encoder power will drop
BAT BATO	21 37	Battery $\ominus$ input Battery $\ominus$ input	These are connection terminals of battery for back-up. The voltage must be 2.8 to 4.5V. (The battery should be provided by user.)

Table 5 5 Output Signals of Connector 1CN

Signal Name	Connector 1CN No	Function	Description	
$\overline{OL}$	1CN-40(25)	Overload detection	Motor overload detection or heat sink overheat detection. Turns off when overload is detected. (See Fig. 4.1 "Overload characteristic".)	
MCCB	1CN-43(42)	MCCB trip	Turns ON when MCCB trips	
$\overline{ALM}$	1CN-38(39)	Servo alarm	Turns OFF when fault is detected. For details, refer to Table 6.2. "Fault Detection Function"	
TGON	22(23)	Turns on when motor speed exceeds following speeds	<ul style="list-style-type: none"> <li>• SW4-⑦ open</li> <li>• SW4-⑦ shorted</li> </ul> M Series 20r/min $\pm 10\%$ or more      240r/min $\pm 10\%$ or more F, D Series 25r/min $\pm 10\%$ or more      300r/min $\pm 10\%$ or more S Series 40r/min $\pm 10\%$ or more      480r/min $\pm 10\%$ or more	
CLT	1CN-5 (6)	Current limit detection	<ul style="list-style-type: none"> <li>• N-CL or P-CL used: Turns ON when output torque reaches the level set by N-CL or P-CL</li> <li>• N-CL or P-CL not used: Turns ON when output torque reaches the level set by potentiometer <math>\overline{CUR}</math></li> </ul>	
S-RDY	1CN-28(27)	When SEN signal is "H" and absolute encoder is operating, turns ON when main power supply ON and servo alarm OFF		
+12 V	1CN-16, 48	$\pm 12$ V output power supply	$\pm 12$ V $\pm 5\%$ max. output current 30 mA. Used with speed command or current input	
0 V	1CN-17, 32, 49			
-12 V	1CN-31, 46			
TRQ-M	1CN-9	Torque monitor	(Rated torque at $\pm 3.0$ V) $\pm 10\%$ , $\pm 9$ V max, load 1 mA max	
VTG-M	1CN-10	Speed monitor	M, F, D Series ( $\pm 4.0$ V/1000r/min) $\pm 5\%$ S Series ( $\pm 2.0$ V/1000r/min) $\pm 5\%$ Load 1 mA max	
PAO	1CN-33	Positioning Signal Output	Pulse after frequency division is output line driver (MC 3487*) To be received by line receiver (MC 3486*)	
*PAO	1CN-34			Phase A
PBO	1CN-35			Phase B
*PBO	1CN-36			
PCO	1CN-19			Phase C
*PCO	1CN-20			

\*Made by Texas Instrument Inc

## 5.5 CONNECTOR TERMINAL (2CN) FOR ABSOLUTE ENCODER CONNECTION

### 5.5.1 Specifications of Applicable Receptacles and Cables (Table 5.6)

Table 5.6 Specifications of Applicable Receptacles and Cables

Connector Type* used in Servopack	Applicable Receptacle Type				Connection Cable#
	Manufacturer	Soldered Type	Caulking Type	Case †	
MR-20RMA, right angle 20P	Honda Tsushin Co., Ltd	MR-20F ‡	MRP-20F01	MR-20L ‡	DP8409123 or DE8400093

\*Made by Honda Tsushin Co., Ltd

†Attached to each applicable receptacle (soldered and caulking types)

‡Attached to Servopack when shipping

#The cables listed in Table 5.7 and available on request

If required, purchase in units of standard length as shown in Table 5.7

Table 5.7 Details of Specifications of Applicable Cables

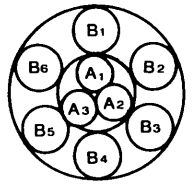
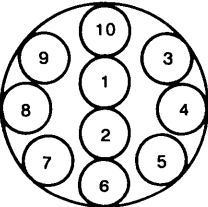
Connection	Soldered Type	Caulking Type																																						
Yaskawa Drawing No	DP 8409123	DE 8400093																																						
Manufacturer	Fujikura Cable Co																																							
General Specifications	Double, KQVV-SW AWG 22 × 3 C AWG 26 × 6 P	KQVV-SB AWG 26 × 10 P																																						
Internal Composition and Lead Color	For Soldered Type	For Caulking Type																																						
																																								
	<table border="1"> <tr><td>A1</td><td>Red</td></tr> <tr><td>A2</td><td>Black</td></tr> <tr><td>A3</td><td>Green/yellow</td></tr> <tr><td>B1</td><td>Blue/White/blue</td></tr> <tr><td>B2</td><td>Yellow/White/yellow</td></tr> <tr><td>B3</td><td>Green/White/green</td></tr> <tr><td>B4</td><td>Orange/White/orange</td></tr> <tr><td>B5</td><td>Purple/White/purple</td></tr> <tr><td>B6</td><td>Grey/White/grey</td></tr> </table>	A1	Red	A2	Black	A3	Green/yellow	B1	Blue/White/blue	B2	Yellow/White/yellow	B3	Green/White/green	B4	Orange/White/orange	B5	Purple/White/purple	B6	Grey/White/grey	<table border="1"> <tr><td>1</td><td>Blue-White</td></tr> <tr><td>2</td><td>Yellow-White</td></tr> <tr><td>3</td><td>Green-White</td></tr> <tr><td>4</td><td>Red-White</td></tr> <tr><td>5</td><td>Purple-White</td></tr> <tr><td>6</td><td>Blue-Brown</td></tr> <tr><td>7</td><td>Yellow-Brown</td></tr> <tr><td>8</td><td>Green-Brown</td></tr> <tr><td>9</td><td>Red-Brown</td></tr> <tr><td>10</td><td>Purple-Brown</td></tr> </table>	1	Blue-White	2	Yellow-White	3	Green-White	4	Red-White	5	Purple-White	6	Blue-Brown	7	Yellow-Brown	8	Green-Brown	9	Red-Brown	10	Purple-Brown
A1	Red																																							
A2	Black																																							
A3	Green/yellow																																							
B1	Blue/White/blue																																							
B2	Yellow/White/yellow																																							
B3	Green/White/green																																							
B4	Orange/White/orange																																							
B5	Purple/White/purple																																							
B6	Grey/White/grey																																							
1	Blue-White																																							
2	Yellow-White																																							
3	Green-White																																							
4	Red-White																																							
5	Purple-White																																							
6	Blue-Brown																																							
7	Yellow-Brown																																							
8	Green-Brown																																							
9	Red-Brown																																							
10	Purple-Brown																																							
Finishing Dimensions	φ 8.0 mm	φ 10.0 mm																																						
Yaskawa Standard Specifications	Standard length 5 m, 10 m, 20 m Terminal ends are not provided (with connectors)																																							

### NOTE

- When applicable cables listed in Table 5.7 are used, allowable wiring distance between Servopack and motor is a maximum of 20 meters
- The cable applied for 50 m wiring distance is available on order (Yaskawa drawing No DP8409179) If wiring distance is 20 m or more, contact your Yaskawa representative

### 5.5.2 Servopack Connector (2CN) Terminal Layout and Connection

The terminal layout for the Servopack connectors (2CN) for connecting the absolute encoder is shown in Table 5.8, and the connection method of 2CN and the absolute encoder, in Figs. 5.4 and 5.5.

Table 5.8 Connector 2 CN Layout of Servopack

1	2	3	4	5	6	7
PG0V	PG0V	PG0V	PG5V	PG5V	PG5V	DIR
	8	9	10	11	12	13
	OHM1	OHM2	—	ODIR	BAT	BATO
14	15	16	17	18	19	20
PC	*PC	PA	*PA	PB	*PB	FG

5 5 2 **Servopack** Connector (2CN) Terminal Layout and Connection (Cont'd)

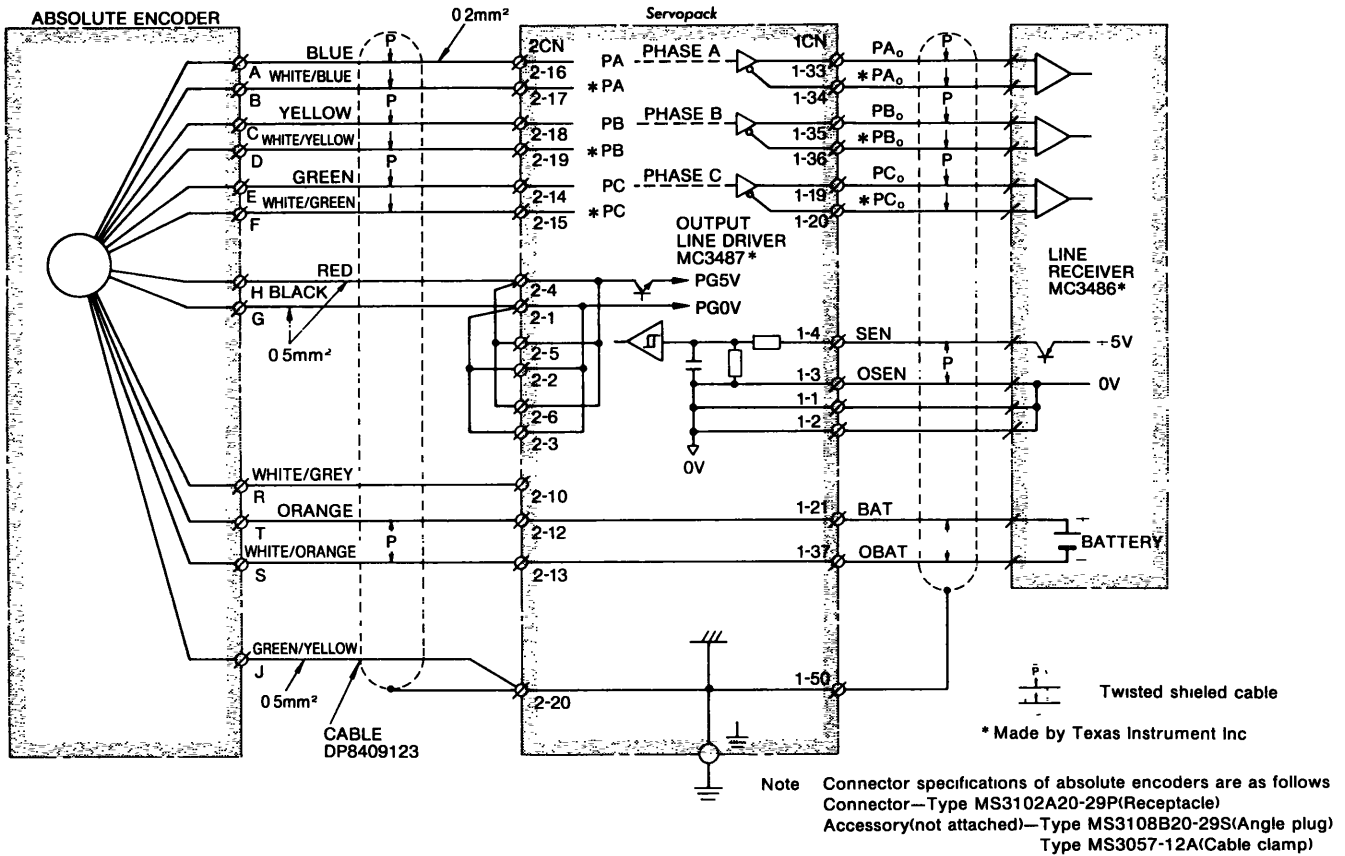

Fig 5 5 Soldered Type Connector 2CN Connection and 1CN Output Processing (When using Connection Cable DP8409123)

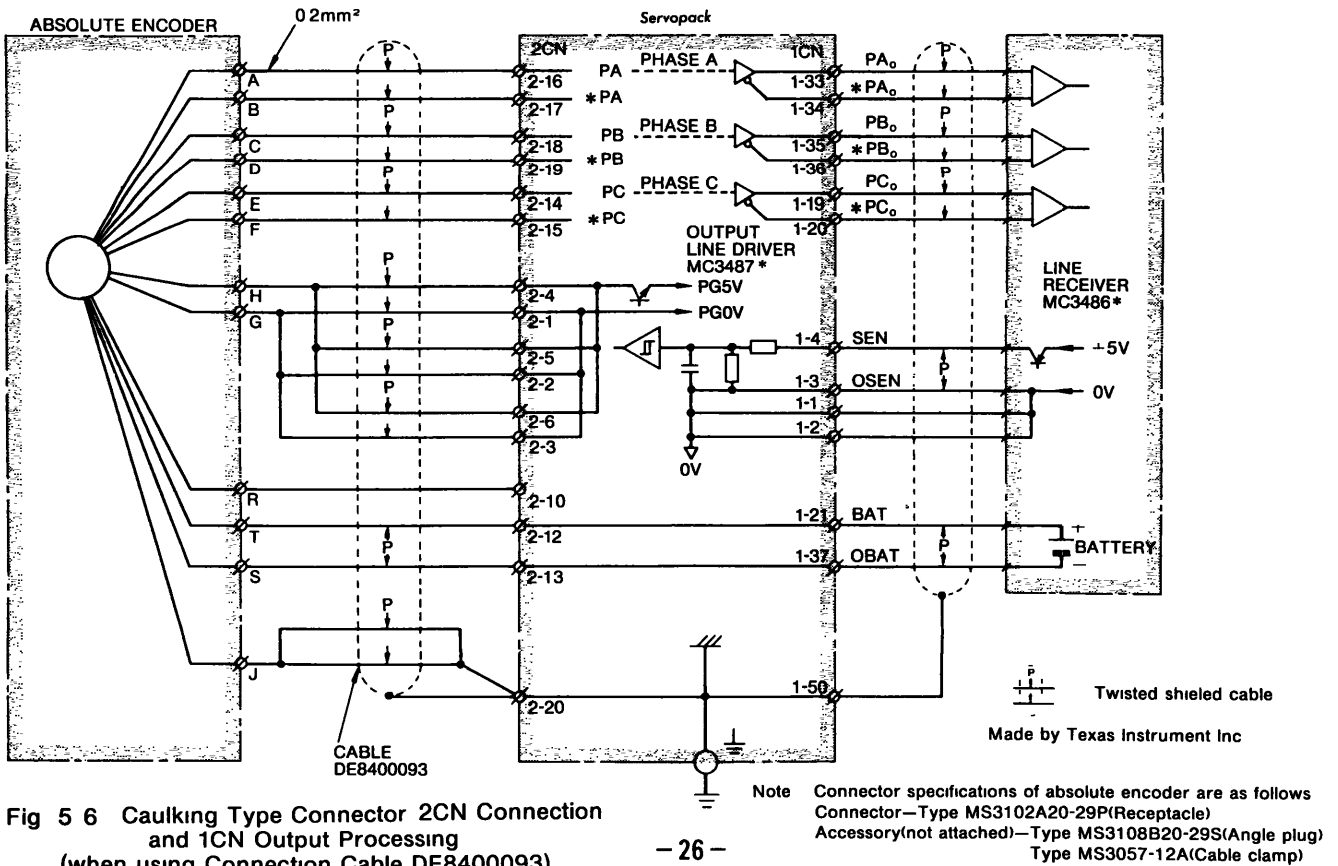

Fig 5 6 Caulking Type Connector 2CN Connection and 1CN Output Processing (when using Connection Cable DE8400093)

## 6. OPERATION

### 6.1 POWER ON AND OFF

Arrange the sequence so that the power is simultaneously supplied to the main circuit (R,S,T) and the control circuit (r,t), or supplied to the control circuit first, then the main circuit (Figs. 6.1 and 6.2).

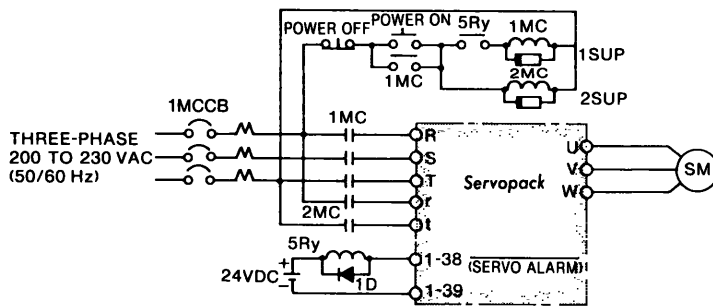
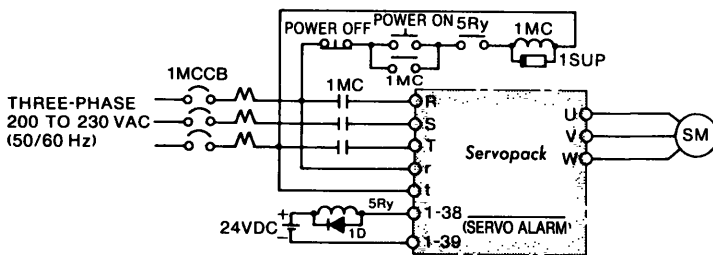

Fig 6 1 Connection Example for Simultaneous Control Power ON/OFF



1SUP, 2SUP Surge suppressor CR50500BA or equivalent (made by Okaya Electric Industries Co. Ltd.)  
1D Flywheel diode (to prevent spike of 5Ry)

Fig 6 2 Connection Example for Main-circuit Power ON/OFF

Arrange the sequence so that the power is simultaneously cut (including momentary power failure) (Fig. 6.1), or the power to the main circuit is cut first, then the control circuit (Fig. 6.2). The order is the reverse of the power ON sequence. Precautions for connections in Figs. 6.1 and 6.2 are as follows.

- Make sequence to assure that the main-circuit power will be cut off by a servo alarm signal.

If the control circuit is turned off, the LED indicating the kind of servo alarm also goes off.

- When power is supplied to the power ON/OFF sequence shown in Fig. 6.1, the normal signal is set (5Ry is turned on) in the control circuit after a maximum delay of 1 second.

### NOTE

When the power is turned on, a servo alarm signal continues for approximately 1 second (normally 200 to 300 ms) to initialize the **Servopack**

Hold the main-circuit power ON signal for approximately 1 second. However, this is unnecessary in the sequence in Fig. 6.2, because the control power is always turned on.

- Since Servopack is of a capacitor input type, large recharging current flows when the main-circuit power is turned on (recharging time: 0.5s). If the power is turned on and off frequently, the recharging-current limit resistor may be degraded and a malfunction may occur. When the motor starts, turn ON the speed reference and turn it OFF when the motor stops. Do not turn the power ON or OFF.
- Before power on or off, turn off the "Servo-ON" switch to avoid transient troubles.

## 6.2 SPEED REFERENCE

### 6.2.1 Speed Reference Circuit

From the Servopack built-in control power (1CN-⑬, ⑭: +12V, 1CN-⑮, ⑯, ⑰, ⑱: 0V, 1CN-⑲, ⑳: -12V) or the external power, the speed reference voltage is given to 1CN-⑫ and ⑬ or to 1CN-⑭ and ⑮. When the Servopack built-in control power is used, the motor speed fluctuates in the range of  $\pm 2\%$  of the speed set value.

The method for giving speed reference voltage is described below.

(1) For accurate (inching) speed setting

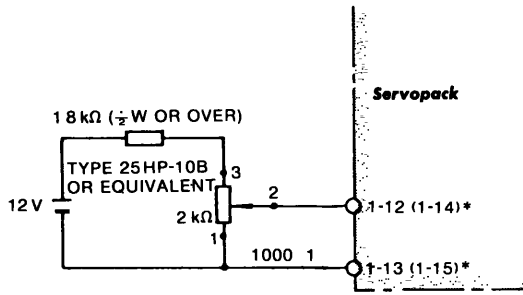

25HP-10B type Multiple-rotation type, wire wound variable resistor (with dial MD10-30B4) made by Sakae Tsushin Inc

(a) When Multiple-rotation Type, Wire Wound Variable Resistor is used

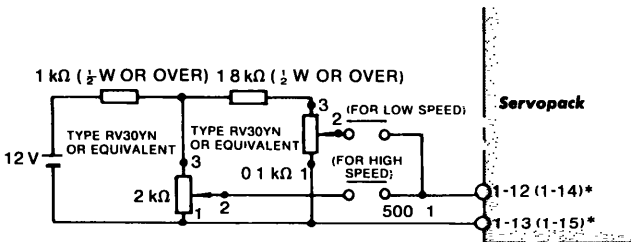

RV30YN type Carbon-film variable resistor made by Tokyo Cosmos Electric

Low- and high-speed relays Reed relay (SRF-B SRG-B) made by Nippon Electric or equivalent, or low-level relay (GzA-432) made by Tateishi Electric or equivalent

Note When a carbon resistor is used a great residual resistance remains, and so the speed control range becomes approximately 500:1

(b) When Carbon Variable Resistor is used

\* Parentheses are for auxiliary input

Fig 6.3 Method for Giving Speed Reference Voltage (for Accurate Speed Setting)

(2) For relatively rough speed setting

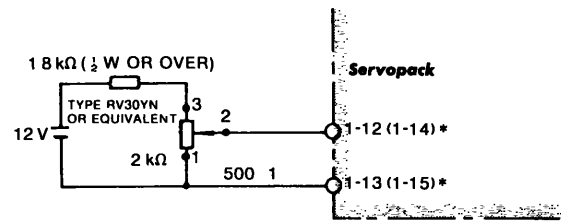

\* Parentheses are for auxiliary input

Note When a carbon resistor is used, a great residual resistance remains, and so the speed control range becomes about 500:1

Fig 6.4 Method for Giving Speed Reference Voltage (for relatively Rough Speed Setting as Compared with Fig 6.3)

### 6.2.2 Stop Reference Circuit

When commanding a stop, do not open the speed reference circuit (1CN-⑫ or 1CN-⑭), but set to 0V.

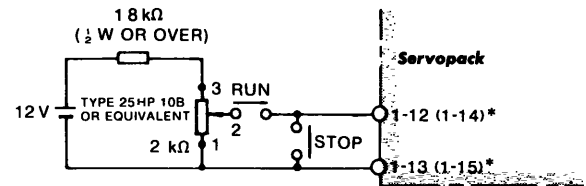

(a) When Multiple-rotation Type, Wire Wound Variable Resistor is used

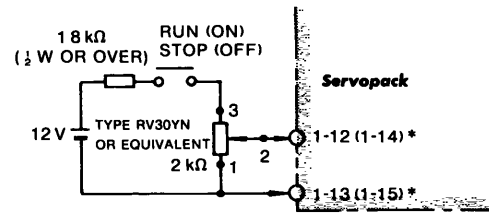

(b) When Carbon Variable Resistor is used

\* Parentheses are for auxiliary input

Fig 6.5 Method for Giving Stop Reference

### 6.2.3 Handling of Speed Reference Input Terminal

The unused terminals, out of the speed reference terminals 1CN-⑫, ⑬ and the auxiliary input terminals 1CN-⑭, ⑮ must be short-circuited.

### 6.2.4 Auxiliary Input Circuit ( $\pm 2$ to $\pm 10$ V)

Auxiliary input circuit is used for application at rated reference voltage other than  $\pm 6$  V.

• Adjustment procedures

Between 1CN-⑭ and ⑮ (⑮ is 0 V), input the voltage to be used to set the rated speed, and adjust the potentiometer  $\overline{\text{IN-B}}$  so that the rated speed is achieved.

When combined with Yaskawa Positionpack in positioning system drive, auxiliary input terminals are normally used as speed reference input. In this case, positioning loop gain is adjusted with the potentiometer  $\overline{\text{IN-B}}$ . For adjustment, be sure to refer to Positionpack instruction manuals.



### 6.3 EXTERNAL CURRENT LIMIT REFERENCE CIRCUIT [P-CL, N-CL]

Current can be limited from the outside as well as within Servopack. The external current limit is used for the following cases:

- To protect the motor from overload current when an abnormal load lock occurs in the load.
- To change the current limit value according to the external sequence.

The current can be limited by multi-stage setting by the use of relays (Fig. 6.6). The same effect can be obtained by giving voltage signals making analog change.

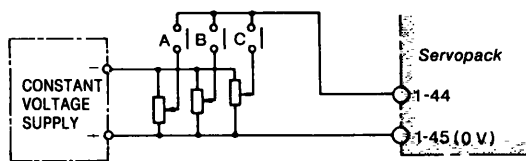

Relay Low-level relay type G2A-432A made by Omron Corporation

Fig 6 6 Multi-stage Switching of Current Value at Forward Side

#### 6 3 1 Method of Giving External Current Limit Reference

Forward current and reverse current can be controlled independently. The forward current can be controlled by giving a reverse voltage (0 to -9.0 V) between Servopack terminals 1CN- ④④ and ④⑤ ; the reverse current can be controlled by a forward voltage (0 to +9.0 V) between terminals 1CN- ②⑨ and ③⑩ .

The relation between the rated current of the motor and current limit values is rated current at 3.0 V for applicable motor. The power supply must use an internal resistance less than  $2k\Omega$ . The input resistance at Servopack side must be greater than  $5k\Omega$ . When external current is not restricted, contacts between terminals 1CN- ④④ and ④⑤ and between 1CN- ②⑨ and ③⑩ are opened.

#### 6 3 2 Set Voltage and Current Limit Values

The relationship between set voltages of 0 to  $\pm 9.0$  V and current limit values are shown in Fig. 6.7. Setting precision is 1 10%.

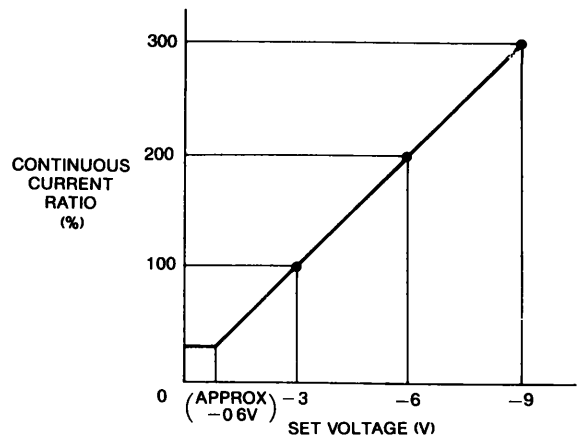

(a) Current Limit at Forward Side

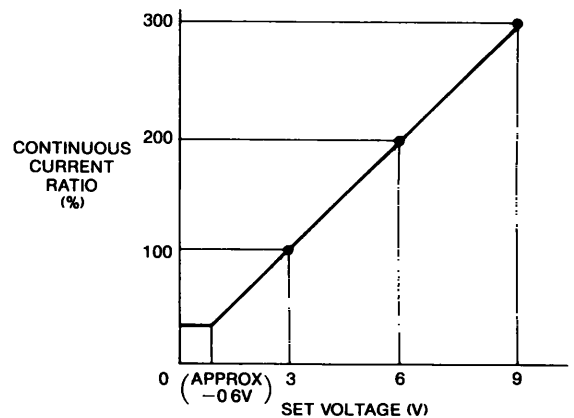

(b) Current Limit at Reverse Side

Note If setting value exceeds max output current value of Servopack, max output current value becomes saturation value

Fig 6 7 Set Voltage and Current Limit Values

#### 6 3 3 Current Limit when Motor is Locked

When locking a motor by applying a current limit, determine a current limit value less than the rated current of the motor. If the load condition requires a current limit exceeding the rated motor current, refer to Par. 6.5.(3) Overload detection level and make sure to unlock the motor before reaching the trip level.

Note that when the speed reference voltage is less than tens or so millivolts (affected by setting of GAIN of 4VR, 6VR and SW3), the motor lock current sometimes pulsates. If this is not desirable, the current pulsation can be removed by increasing the speed reference voltage.

## 6.4 CONFIGURATION OF INPUT/OUTPUT CIRCUIT

For proportional drive, overtravel, servo ON, servo alarm output, current limit detection output, TG ON output, Servo ready output, MCCB trip output and OL alarm output, each input/output circuit is a noncontact circuit insulated with optical couplers. The external circuit, therefore, must be constructed with the specified voltage and current.

### 6.4.1 Input Circuit

There are four types of protective functions to prevent continued rotation of the motor in forward and reverse direction: Servo ON inputs, proportional drive circuits, and overtravel protection circuits. Construct the input circuit using 24 V power supply (Fig. 6.8). Typical circuits are shown in Fig. 5.3.

#### NOTE

The user must provide the 24 V power supply 24VDC  $\pm$ 1V, 20mA or more (approx 5mA/circuit)

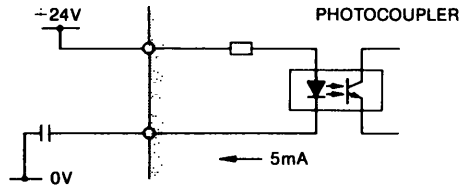

Fig 6.8 Configuration of Input/Output Circuit

#### (1) Proportional Drive Reference [P-CON]

If a position loop is not set for positioning, and after completion of positioning, has been left for quite a long time, the positioned point may have moved due to preamplifier drift. To avoid this, switch the speed amplifier from PI drive to P drive after the positioning and the loop gain in the control system drops and the drift decreases. With several percent of friction load, the motor stops completely.

#### (2) Forward and reverse running inhibit [P-OT, N-OT]

These circuits are used to stop the forward running of the motor (counterclockwise when viewed from the drive end of the motor) and reverse running. This circuit stops output current to drive the motor. Therefore, the motor will coast to a stop. If braking is required, set the speed reference voltage to 0V or set the dynamic braking circuit from OFF to ON. For dynamic brake function, see Par. 6.5 (1).

#### NOTE

When the overtravel prevention circuit is not used, connect 1CN-② and ④ to the 0 V terminal of the external 24 V power supply

#### (3) Servo ON [S-ON]

When SEN signal is high-level and absolute encoder is operational state, this circuit is used to turn on the main-circuit power-drive circuit of the Servopack. When the signal of the circuit is not input (Servo OFF state) or SEN signal is low-level, the motor cannot be driven. If this signal is applied during motor running, the motor will coast to stop.

#### NOTE

Before turning power on or off, turn off the "Servo-ON" switch to avoid troubles resulting from transient current

### 6.4.2 Output Circuit

There are six output signals: Current limit detection, TG ON, Servo alarm, Servo ready, MCCB trip, OL alarm.

These output circuits are non-contact, employing transistors. Voltage and current specifications are:

Applied Voltage ( $V_{max}$ )  $\leq$  30 V

Conduction Current ( $I_p$ )  $\leq$  100 mA

#### NOTE

The output circuit requires a separate power supply. It is recommended to use the same 24 V power supply used for the input circuit (Fig. 6.9)

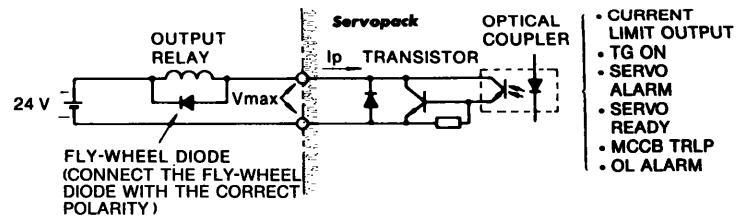

Fig 6.9 Output Circuit

- CURRENT LIMIT OUTPUT
- TG ON
- SERVO ALARM
- SERVO READY
- MCCB TRLP
- OL ALARM

### 6 4 3 Use of Absolute Encoder

The absolute encoder outputs PAO, PBO, and PCO, as shown below:

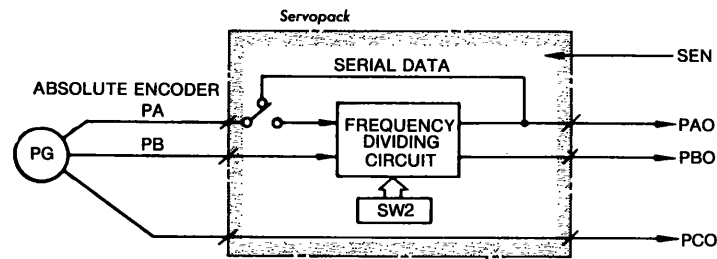

Fig 6 10 Absolute Encoder Output

When SEN signal is input (from a low to high level), absolute data is first output from PAO as serial data, then as initial incremental pulse PAO, PBO (2-phase pulse with 90-degree phase difference).

After this, output operation similar to normal incremental encoder (2-phase pulse with 90-degree phase difference) is performed.

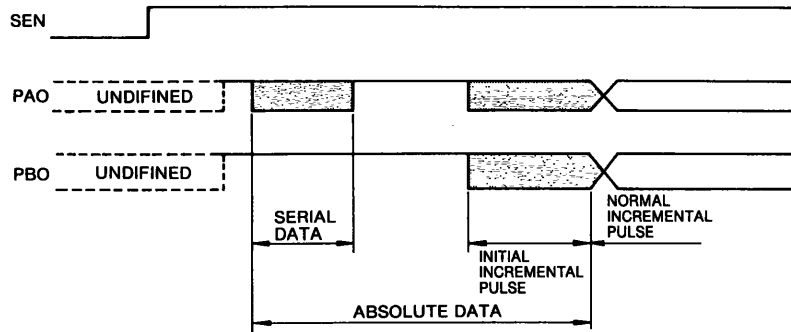

Fig 6 11 Absolute Data Output

#### (1) Absolute data contents

- Serial data:

Indicates the position of the motor shaft (in terms of revolutions) from the reference position (value set at setup time).

- Initial incremental pulse:

Pulse is output at the same pulse speed as rotation is made at about 2747 r/min from the motor shaft origin position to the current motor shaft

(Example)

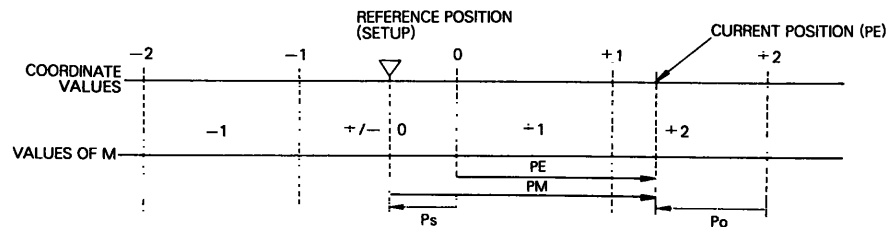

PE: Current value read-out from encoder

M : Multirevolution data

P<sub>0</sub>: Initial incremental pulses read-out from encoder (Normally, negative value)

P<sub>s</sub>: Initial incremental pulses read-out at setup point (Normally, negative value. This value is stored and controlled.)

position. Assuming that the serial data value is M (revolutions), the initial incremental pulse count value is P<sub>0</sub> (pulses), and the number of output pulses per revolution of the motor axis (depending on divider circuit setting) is R (P/R), the current position PE can be found by the expression:

$$PE_i = M \times R + P_0$$

PM: Current value required in customer's system

R : Number of pulses (32768 pulses for this encoder)

$$PE = M \times R + P$$

$$PM = PE - Ps$$

### 6 4 3 Use of Absolute Encoder (Cont'd)

#### (2) Circuit example

Fig. 6.13 shows an example of an absolute encoder output processing circuit.

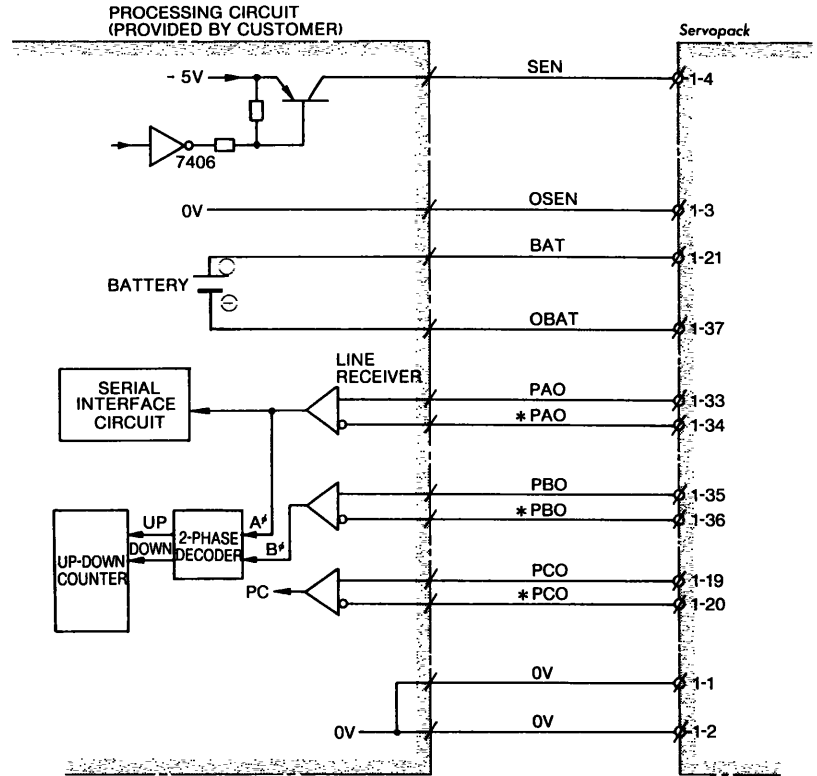

Fig 6 12 Example of Output Processing Cricuit

#### (3) Absolute data reception

Process absolute data in the following sequence:

- ① Make the SEN signal high-level.
- ② After 100 ms, set serial data reception-waiting-state. Clear the up-down counter for count incremental pulses.
- ③ Receive serial data of 8 bytes.
- ④ Normal incremental operation state is entered in approximate 50 ms after the last serial data is received.

#### (4) Serial data specification

Transmission Mode	Asynchronous(ASYNC)
Baud Rate	9600 baud
Start Bit	1 bit
Stop Bit	1 bit
Parity	Even
Character Code	ASCII 7 bits
Data Format	5-digit 8 characters, (P)(+/-)(0 to 9)(CR)

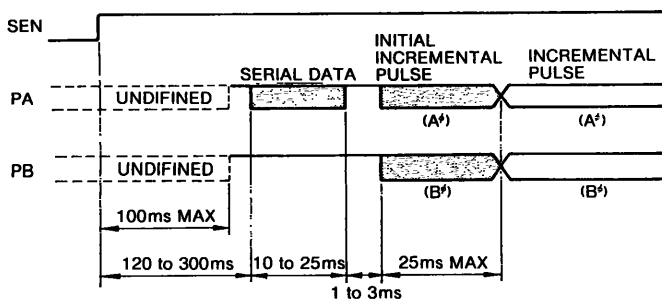

Fig 6 13 Receive Processing of Absolute Data

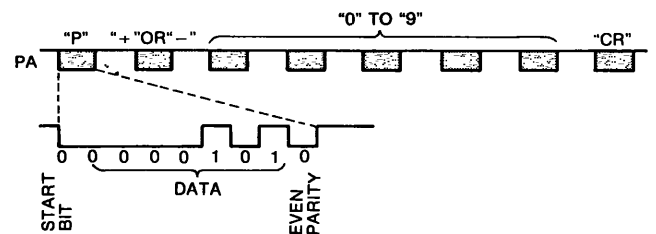

Fig 6 14 Serial Data

Serial data of 8 bytes (8 characters) is sent.

Format: P+XXXXXX CR  
 Carriage Return Code  
 Digit from 0 to 9

The serial data represents the number of revolutions from the reference point (set at setup time). Zero rotation is represented by either P+00000(CR) or P-00000(CR).

For ±99999 revolutions or more, a correct value is not output.

(5) Incremental pulse

Initial incremental pulse giving absolute data and normal incremental pulse are output through the frequency divider. The frequency divider is set by using SW2.

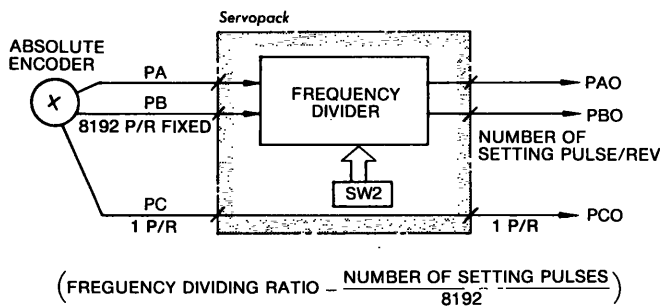

① Output Phase

· For forward running

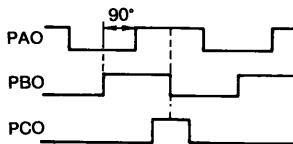

· For reverse running

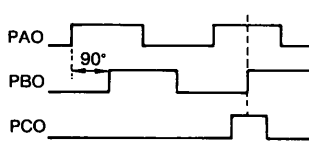
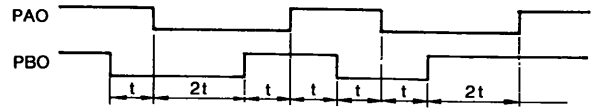

Fig 6 16 Forward/Reverse Output Phase

PCO (origin pulse) synchronizes with PAO, but the pulse width becomes narrow because PCO is not divided. If the dividing ratio is not 1/2n, accurate 90-degree phase difference is not made and the pulses are output as in Fig. 6.17:



(The phase difference t, 2t part equally exists within one revolution, thus the minimum position error results.)

Fig 6 17 Frequency Dividing Ratio and Output Phase Difference

② Frequency divider setting

Set the frequency divider setting switch SW2 as listed in Table 6.1 in accordance with the required resolution.

The frequency dividing ratio is

$$\left( \frac{\text{number of setting pulses}}{8192} \right)$$

For initial incremental pulses, the same number of pulses are output as those made at rotation of about 274 r/min. The PAO, PBO output frequency becomes as shown below.

$$\frac{2747 \times 8192}{60} \times \left( \frac{\text{frequency}}{\text{dividing ratio}} \right)$$

$$= 45.78 \times \left( \frac{\text{number of}}{\text{setting pulses}} \right) \text{ pps.}$$

6 4 3 Use of Absolute Encoder (Cont'd)

Table 6 1 Setting of PG Pulse Frequency Dividing Ratio

Setting						Output Pulses after Dividing (per motor revolution)	Setting						Output Pulses after Dividing (per motor revolution)
1	2	3	4	5	6		1	2	3	4	5	6	
○	○	○	○	○	○	6000	○	○	○	○	○	60	
	○	○	○	○	○	5000		○	○	○	○	50	
○		○	○	○	○	4000	○		○	○	○	40	
		○	○	○	○	3000			○	○	○	30	
○	○		○	○	○	2500	○	○		○	○	25	
	○		○	○	○	2400		○		○	○	20	
○			○	○	○	2000	○			○	○	8192	
			○	○	○	1600				○	○	4096	
○	○	○		○	○	1500	○	○	○		○	2048	
	○	○		○	○	1250		○	○		○	1024	
○		○		○	○	1200	○		○		○	512	
		○		○	○	1000			○		○	256	
○	○			○	○	800	○	○			○	128	
	○			○	○	750		○			○	64	
○				○	○	625	○				○	3600	
				○	○	600					○	2160	
○	○	○	○		○	500	○	○	○	○		1800	
	○	○	○		○	480		○	○	○		1440	
○		○	○		○	400	○		○		○	1080	
		○	○		○	375			○	○		720	
○	○		○		○	320	○	○			○	360	
	○		○		○	300		○			○	180	
○			○		○	250	○			○		90	
			○		○	240				○		45	
○	○	○			○	200	○	○	○			(15)	
	○	○			○	160		○	○			(12)	
○		○			○	150	○		○			(9)	
		○			○	125			○			(8)	
○	○				○	120	○	○				(5)	
	○				○	100		○				(4)	
○					○	80	○					(3)	
					○	75						(2)	

③ Example of output circuit and receiver circuit



- \* Line receiver (1 IC, 2 IC) Type MC3486 made by Texas Instrument Inc
- \* Filter capacitor (C) Type 100PF
- \* Made by Texas Instrument Inc

Fig 6 18 Example of Output Circuit and Receiver Circuit

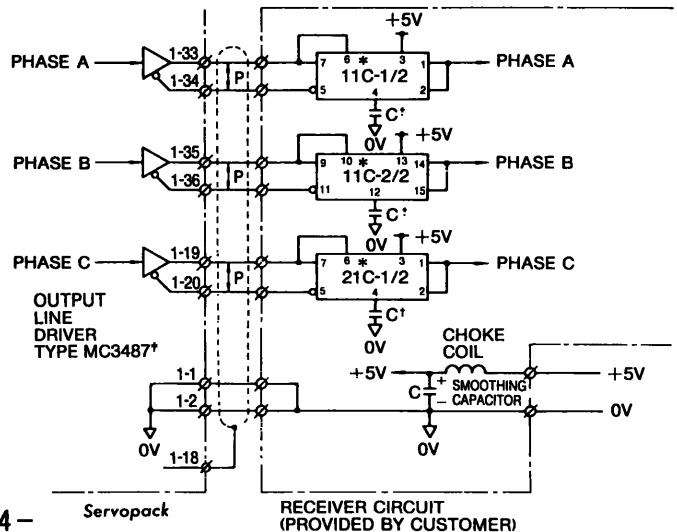

(6) SEN signal

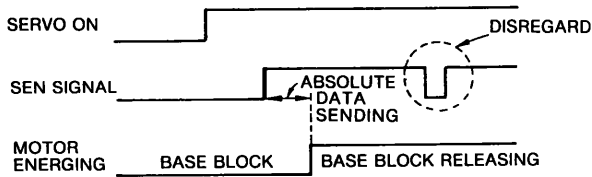

- When the SEN signal level is changed from low to high, +5 V power is applied to the absolute encoder and serial data and initial incremental pulses are sent; then normal operation is started.

If the SEN signal level is changed from high to low when the motor is not energized, +5 V power is not supplied to the absolute encoder.

Even if the SEN signal goes low when the motor is energized, it is disregarded.

NOTE

Do not change the SEN signal level from low to high for one second after control power or main power is turned on. The PAO, PBO undefined time before serial data is sent is prolonged.

- Even if servo ON signal is entered when the SEN signal is low, the motor cannot be energized. (Base block is set.)
- Even if servo ON signal is entered, the motor is not energized until the SEN signal is input and the encoder starts normal operation, that is, sending of serial data and initial incremental pulse is complete.
- Electrical Specifications:

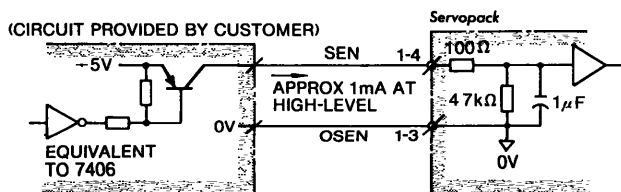

- The transistor type PNP is recommended.
- Signal level { high-level: 4V min.  
low-level: 0.7V max.

Fig 6 19 Electrical Specifications of SEN Signal

(7) Battery

Be sure to use battery to store position information if absolute encoder power should fail. The following battery is recommended:

- Lithium battery\*: type ER6C, 3.6V×J

For battery replacement method, see par. 11.

\*Made by TOSHIBA CORP.

NOTE

- Securely connect the battery so as to prevent an environmental change or a change with the passage of time from causing contact failure.
- Battery voltage is not monitored in the servopack. Prevent the voltage from falling below 2.8 V. If necessary in the system, provide a battery voltage lowering detection circuit or monitor.

(8) Setup method

If revolution amount data is to be set to 0 at motor start or the absolute encoder is not connected to the battery for more than four days, the following setup is required: (This is because the encoder capacitor is discharged and the internal elements may not operate normally.)

Perform the setup in numerical sequence. If this is not done, trouble may occur.

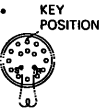

① Discharge of the encoder capacitor

Short-circuit across R and S pins of encoder connector for two minutes or more.

If the extension lead of the encoder side does not have a connector, short-circuit between reset-signal line (purple) and 0V (white/purple).

② Wiring and battery connection

Wire the cable normally to connect battery to the encoder.

③ Turning power ON

Turn on the Servopack power and make the SEN signal high level. If alarm  is output at that time, begin again from ①.

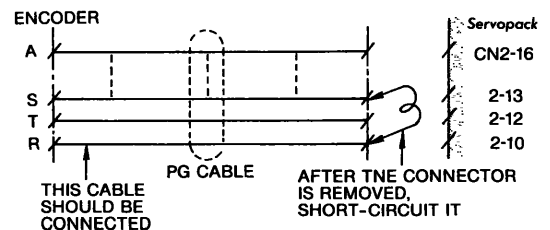

Fig 6 20 Setup Method by PG Cables

## 6.5 PROTECTIVE CIRCUIT

Servopack provides functions to protect the body and motor from malfunctions.

### (1) Dynamic brake function

Servopack incorporates a dynamic brake for emergency stop. This brake operates when:

- Alarm (fault detection) occurs.
- Servo ON command is opened.
- Main power supply is tuned off.

Normally, this dynamic brake is not applied while the motor stops, but can be made operational by switching built-in switch (SW 4-5) from OFF to ON.

### (2) Trouble detecting functions

Table 6 2 Trouble Detecting Functions

Trouble	Detection
Overcurrent	Overcurrent flow in the main circuit (at 1.2 times min inst max current)
Circuit Protector Trip	Circuit protector tripped
Regeneration Trouble	Regenerative circuit not activated in Servopack
Overvoltage	Excessively high DC voltage in the main circuit (approx 420V)
Overspeed	Excessively large speed reference input
Voltage Drop	Low DC voltage in the main circuit after power ON (150V or less)
Overload	Overload condition of motor and Servopack
Heat Sink Overheat	Overheat of heat sink (approx 85°C min)
A/D Error	Element error on the printed circuit board of Servopack
Open Phase	Any one phase open in three-phase power supply
Overrun Prevention	Wrong wiring of motor circuit or PG signal line
CPU Error	Any error of CPU
Absolute Control Error	Error for control circuit, operation and connection of absolute encoder, etc.
Motor with Thermoswitch Overheat	Overheat of motor with thermoswitch

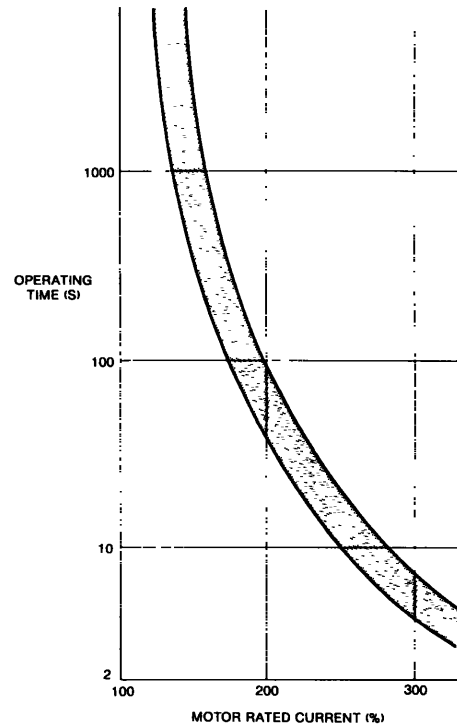

Fig 6 21 Overload Characteristics

### (3) Overload (OL) detection level

Fig. 6.21 shows the setting of overload detection level at 100% rated motor current.

### (4) Servo alarm output [ALM+, ALM-]

If any trouble detection circuits in Table 6.2 functions, the power drive circuit in the Servopack goes off, 8-segment LEDs indicate the operation condition and a servo alarm signal is output.

### (5) Protective circuit operation

An alarm signal indicates some trouble. Check the cause and correct the trouble, and restart the operation. Before checking the cause, turn off the power to the main circuit to avoid danger. Apply the sequence so that the alarm signal turns off only the main circuit (Ⓜ, Ⓢ, Ⓣ), as shown in Figs. 6.1 and 6.2. This allows rapid reaction in the event of a malfunction.

If the power to the control circuit (Ⓣ, Ⓣ) is simultaneously turned off, this also turns off the LED in the Servopack indicating the cause of the alarm signal.

## CAUTION

When an alarm signal cuts off only the main circuit, set the speed reference to 0V before supplying power to the main circuit to resume the operation



(6) Resetting servo alarm

(except for absolute encoder error and positioning error)

To reset the servo alarm, press the **RESET** (blue pushbutton switch) on the printed circuit board in the Servopack.

If **[7.]** or **[A]** is on (e.g., Servopack is overloaded or the heat sink is overheated), the reset alarm is not immediate and occurs a few minutes later. For the correction action of absolute encoder error and positioning error, refer to Par. 12.2.1.

**6.6 LED INDICATION**

Table 6 3 LED Status Indications (Green)

LED Name	Conditions
<b>[MP]</b>	Servopack main circuit voltage (200VDC or more) is proper
<b>[P]</b>	Servopack control circuit voltage (+5V) is proper
<b>[IN]</b>	Speed reference (approx 60 mV or more) is input

Table 6 4 LED Trouble Indications (8-segment, Red)

Indication	Detection	Output Signals
<input type="checkbox"/>	Base current not interrupted (normal operation)	—
<input type="checkbox"/>	Base current is interrupted in Servopack power circuit	—
<b>[1]</b>	Overcurrent	Servo alarm output
<b>[2]</b>	Circuit protector tripped	
<b>[3]</b>	Regeneration trouble	
<b>[4]</b>	Overvoltage	
<b>[5]</b>	Overspeed	
<b>[6]</b>	Voltage drop	
<b>[7]</b>	Overload	
<b>[A]</b>	Heat sink overheat	
<b>[b]</b>	A/D error	
<b>[F]</b>	Open phase	
<b>[C]</b>	Overrun prevention	
<input type="checkbox"/>	CPU error	
<b>[0]</b>	Absolute control error	
<b>[8]</b>	Positioning error	

**6.7 PRECAUTIONS FOR APPLICATION**

6 7.1 Minus Load

The motor is rotated by the load; it is impossible to apply brake (regenerative brake) against this rotation and achieve continuous running.

Example: Driving a motor to lower objects (with no counterweight)

Since Servopack has the regenerative brake capability of short time (corresponding to the motor stopping time), for application to a minus load, contact Yaskawa representative.

6 7 2 Load Inertia (J<sub>L</sub>)

The allowable load inertia J<sub>L</sub> converted to the motor shaft must be within five times the inertia of the applicable AC servomotor. If the allowable inertia is exceeded, an overvoltage alarm may be given during deceleration. If this occurs, take the following actions:

- Reduce the current limit.
- Slow down the deceleration curve.
- Decrease the maximum speed.

For details, contact Yaskawa representative.

6 7 3 High Voltage Line

If the supply voltage is 400/440 V, the voltage must be dropped three-phase, 400/440V to 200 V by using a power transformer. Table 6.6 shows the transformer selection. Connection should be made so that the power is supplied and cut through the primary side of the transformer. Single-phase 100 V class power supply should not be used.

**6.8 PRECAUTIONS OF OPERATION**

6 8 1 Noise Treatment

Servopack uses a power transistor in the main circuit. When these transistors are switched, the effect of  $\frac{di}{dt}$  or  $\frac{dv}{dt}$  (switching noise) may sometimes occur depending on the wiring or grounding method.

The Servopack incorporates CPU. This requires wiring and treatment to prevent noise interference. To reduce switching noise as much as possible, the recommended method of wiring and grounding is shown in Fig. 6.22.

(1) Grounding method (Fig. 6.22)

- Motor frame grounding

When the motor is at the machine side and grounded through the frame, Cf  $\frac{di}{dt}$  current flows from the PWM power through the floating capacity of the motor. To prevent this effect of current, motor ground terminal ⊕ (motor frame) should be connected to terminal ⊖ of Servopack. (Terminal ⊕ of Servopack should be directly grounded.)

- Servopack SG 0V

Noise may remain in the input signal line, so make sure to ground SG 0V. When motor wiring is contained in metal conduits, the conduits and boxes must be grounded. The above grounding uses one-point grounding.

6 8 1 Noise Treatment(Cont'd)

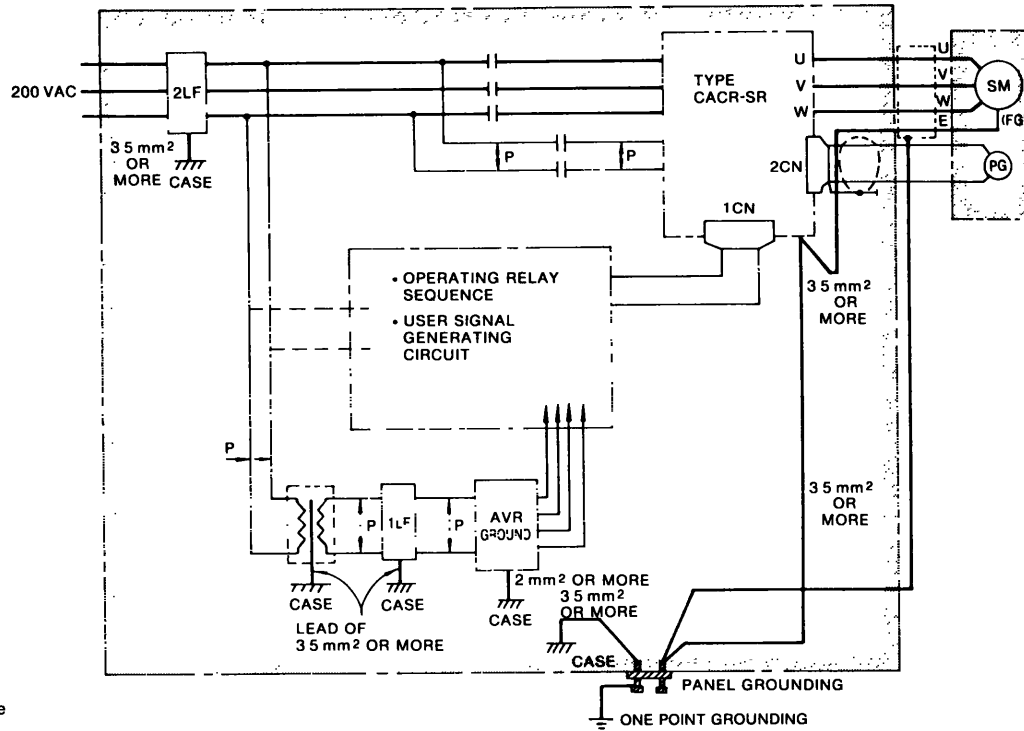

Twisted cable

- Note
- 1 Use wires of 3.5 mm<sup>2</sup> or more for grounding to the case (preferably flat-woven copper wire)
  - 2 Connect line filters observing the precautions as shown in (2) Noise filter installation

Fig 6 22 Grounding Method

(2) Noise filter installation

When noise filters are installed to prevent noise from the power line, the block type must be used. The recommended noise filter is shown in Table 6.5. The power supply to peripherals also needs noise filters.

**NOTE**

If the noise filter connection is wrong, the effect decreases greatly. Observing the precautions, carefully connect them as shown in Figs 6 23 to 6 26

Table 6 5 Recommended Noise Filter

Servopack Type CACR-	Applicable Noise Filter	Recommended Noise Filter	
		Type	Specifications
SR03BZ SR05BZ	 CORRECT	LF-305	Three-phase 200 VAC class, 5 A
SR07BZ		LF-310	Three-phase 200 VAC class, 10 A
SR10BZ SR15BZ		LF-315	Three-phase 200 VAC class, 15 A
SR20BZ		LF-320	Three-phase 200 VAC class, 20 A
SR30BZ		LF-330	Three-phase 200 VAC class, 30 A
SR44BZ		LF-340	Three-phase 200 VAC class, 40 A
SR60BZ	LF-350	Three-phase 200 VAC class, 50 A	

Note Noise filter made by Tokin Corp

- (a) Separate the input and output leads. Do not bundle or run them in the same duct.

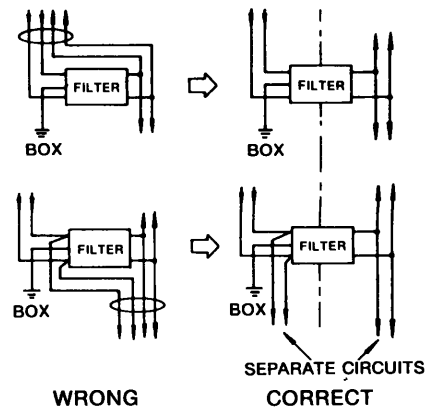

Fig 6 23

(b) Do not bundle the ground lead with the filter output line or other signal lines or run them in the same duct.

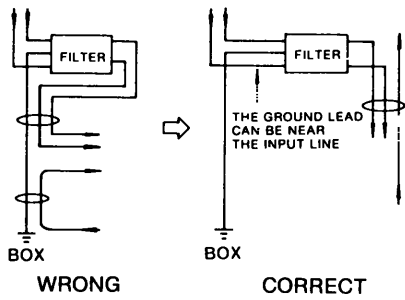

Fig 6 24

(c) Connect the ground lead singly to the box or the ground panel.

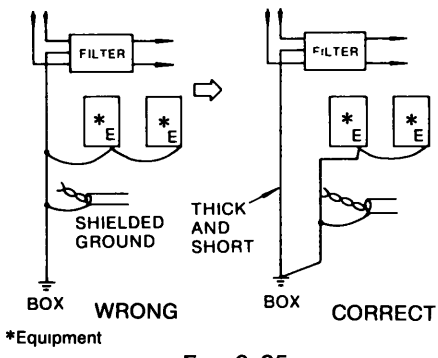

Fig 6 25

(d) If the control panel contains the filter, connect the filter ground and the equipment ground to the base of the control unit.

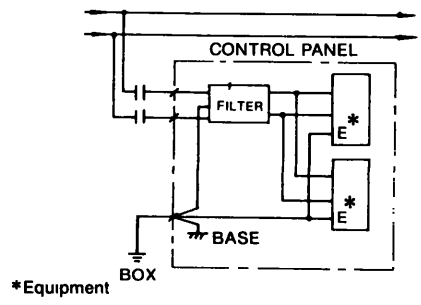

Fig 6 26

6 8 2 Power Line Protection

The Servopack is operated through the commercial power line(200 V). To prevent the power line accidents due to grounding error, contact error, or to protect the system from a fire, circuit breakers(MCCB) or fuses must be installed according to the number of Servopacks used (Table 6.6).

A quick-melting fuse cannot be used, because the Servopack uses the capacitor-input power supply and the charging current might melt such a fuse.

Table 6 6 Power Supply Capacity and MCCB or Fuse Capacity

Servopack Type CACR-	Power Capacity* per Servopack	Current Capacity per MCCB or Fuse
SR03BZ	0.65 kVA	5 A
SR05BZ	1.1 kVA	5 A
SR07BZ	1.5 kVA	8 A
SR10BZ	2.1 kVA	8 A
SR15BZ	3.1 kVA	10 A
SR20BZ	4.1 kVA	12 A
SR30BZ	6.0 kVA	18 A
SR44BZ	8.0 kVA	24 A
SR60BZ	11 kVA	32 A

\*Values at rated load

6.9 APPLICATION

6'9 1 Connection for Reverse Motor Running

If the machine construction requires that the normal forward reference is used for reverse motor running and the normal reverse reference for forward running, short across CN2-11 and CN2-7 of connector 2CN for the PG. In this case, change of motor and PG connection is not required.

If the CN2-11 and CN2-7 are shorted, normal incremental pulse and initial incremental pulse in absolute data are output in the reverse direction, but serial data code in absolute data is not reversed. Therefore, when the connection for reverse motor running is used, reverse the serial data code.

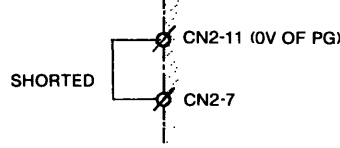

Fig 6 27

6 9 2 Speed and Torque Measurement

When an instrument is connected to measure speed and torque, make the connection as shown in Fig. 6.28, using a DC ammeter of ±1 mA (both swing).

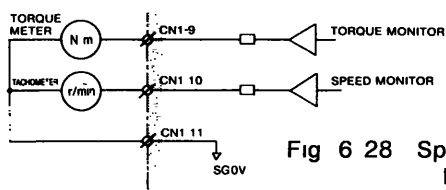

Fig 6 28 Speed and Torque Measurement

- Torque monitor output(CN1-9): ±3.0 V ±10%/100% torque
- Speed monitor output(CN1-10):  
M, F series — ±4.0 V ±5%/1000 r/min  
S series — ±2.0 V ±5%/1000 r/min
- Instrument: ±1 mA (both swing) ammeter.  
Use ammeter of DCF-6 or DCF-12N by Toyo Instrument or equivalent.
- Example: When an M Series motor (rated speed: 1000 r/min) is used, and speeds are to be measured up to the maximum speed (2000 r/min) in both directions, use ±8V (both swing) DC voltmeter.

### 6 9 3 Application of **Servomotors** with Holding Magnetic Brake

AC servomotors with brake is held by the brake when it stops operation. Follow the procedures below for use.

(1) This brake locks at non-magnetization. Therefore, turn off the brake power supply when the motor stops. Should the brake work while the motor is rotating, the contact causes excessive abrasion and the brake may be defective in shorter period.

(2) The brake has delay time. For operation timing of ON/OFF, see Fig. 6.29.

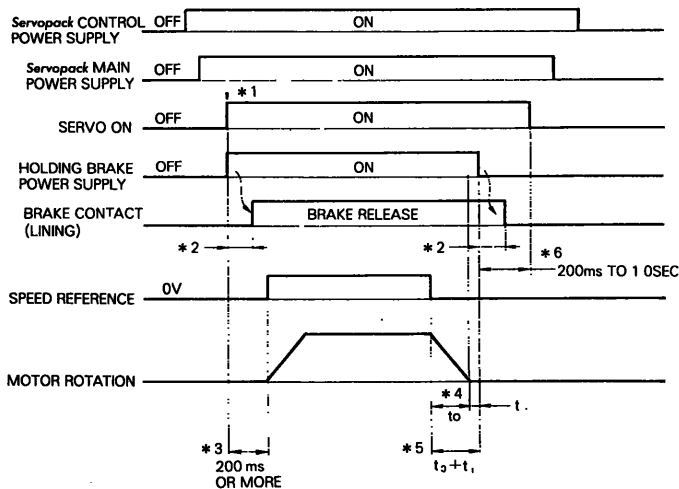

Fig 6 29 Brake Timing

#### Timing

- \*1 "Servo On" and the holding brake power supply can be operated simultaneously.
- \*2 It takes a maximum of 180ms from when the brake power supply is ON till when mechanical contact is released. It takes a maximum of 100ms when the brake power supply is OFF.
- \*3 More than 200ms must be considered from when the brake power supply is ON till when speed reference is input.
- \*4  $t_0$  shows motor stopping time and is calculated as follows

$$t_0 = \frac{4(J_M + J_L) \times N_M}{375 \times (T_P + T_L)} \text{ (SEC)}$$

$J_M (=GD_M^2/4)$  Moment of rotor inertia  
( $\text{kg} \cdot \text{cm}^2 = \text{lb} \cdot \text{in} \cdot \text{s}^2 \times 10^{-3}$ )

$J_L (=GD_L^2/4)$ : Moment of load inertia  
( $\text{kg} \cdot \text{cm}^2 = \text{lb} \cdot \text{in} \cdot \text{s}^2 \times 10^{-3}$ )

$N_M$ : Motor speed (r/min)

$T_P$ : Motor speed reduction torque (N·m)

$T_L$ : Load torque (N·m)

\*5 Turn off the brake power supply when the motor stops. For normal operation,  $t_0 + t_1$  is approximately 1 to 2 seconds.

\*6 Turn off "servo ON" 0.2 to 1.0 second after the brake power supply is turned OFF.

## 7. INSTALLATION AND WIRING

### 7.1 RECEIVING

This motor has been put through severe tests at the factory before shipped. After unpacking, however, check and see the following.

- Its nameplate ratings meet your requirements.
- It has sustained no damage while in transit.
- The output shaft should be hand-rotated freely. However, the brake-mounted motor does not rotate as it is shipped with the shaft locked.
- Fastening bolts and screws are not loose.

If any part of the motor is damaged or lost, immediately notify us giving full details and nameplate data.

### 7.2 INSTALLATION

#### 7 2 1 AC Servomotor

AC Servomotor can be installed either horizontally or vertically.

(1) Before mounting

Wash out anticorrosive paint on shaft extension and flange surface with thinner before connecting the motor to the driven machine. See Fig. 7.1.

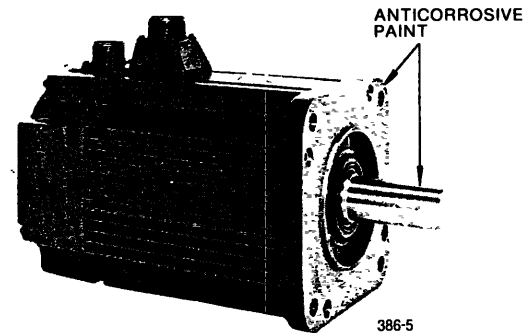

Fig 7 1 Anticorrosive Paint to be Removed

(2) Location

Use the motor under the following conditions.

- Indoors
- Free from corrosive and/or explosive gases or liquids
- Ambient temperature: 0 to +40°C
- Clean and dry
- Accessible for inspection and cleaning

If the AC servomotor is subject to excessive water or oil droplets, protect the motor with a cover. The motor can withstand a small amount of splashed water or oil.

### (3) Environmental conditions

Ambient Temperature: 0 to +40°C

Storage Temperature: -20 to +60°C

Humidity: 20% to 80% RH(non-condensing)

### (4) Load coupling

True alignment of motor and driven machine is essential to prevent vibration, reduced bearing and coupling life, or shaft and bearing failures.

Use flexible coupling with direct drive. The alignment should be made in accordance with Fig. 7.2.

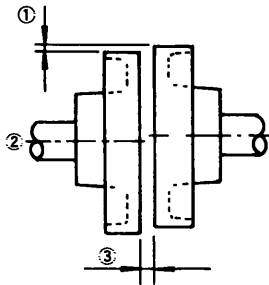

① Measure the gap between the straightedge and coupling halves at four equidistant points of the coupling. The each reading should not exceed 0.03 mm

② Align the shafts

③ Measure the gap between the coupling faces at four equidistant points around the coupling rim with thickness gage. The maximum variation between any two readings should not exceed 0.03 mm

Fig 7 2 Alignment of Coupling

### (5) Allowable bearing load

Avoid both thrust and radial loads to the motor shaft. If unavoidable, never exceed the values in Tables 4.1 to 4.3.

## 7 2 2 Servopack

### (1) Installation

The Servopack type CACR-SR is mounted on the base as standard.

### (2) Location

- When installed in a panel:

Keep the temperature around Servopack at 55°C or below. (Fig. 7.3)

- When installed near a heat source:

Keep the temperature around Servopack below 55°C. (Fig. 7.4)

- If subjected to vibration:

Mount the unit on shock absorbing material.

- If corrosive gases are present:

Avoid locations where corrosive gases exist as it may cause extensive damage over long use. Especially vulnerable are switching operation of contactors and relays.

- Unfavorable atmospheric conditions:

Select a location with minimum exposure to oil, water, hot air, high humidity, excessive dust or metallic particles.

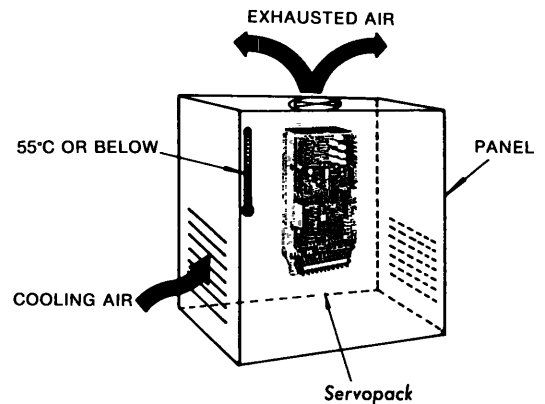

Fig 7 3 Typical Layout for Panel Mounting

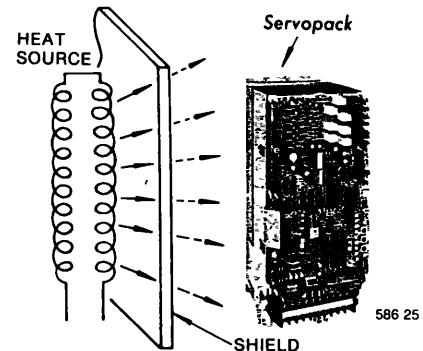

Fig 7 4 Protection against Heat Radiation

### (3) Mounting Direction

Mount the unit vertically on the wall using the mounting holes (4) on the base plate, with main terminals at the bottom. (Fig. 7.5)

- VERTICAL MOUNTING

- HORIZONTAL MOUNTING

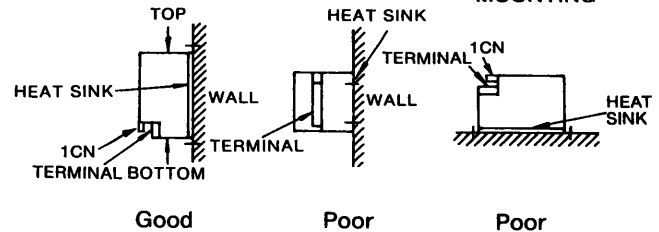

Fig 7 5 Mounting Direction of Servopack

## 7.3 WIRING

### 7 3 1 Rated Current and Cable Size

Tables 7.1 and 7.2 show external terminals, rated current, and cable sizes of the power unit and Servopack, respectively. Select the type and size of cables to meet ambient conditions and current capacity. The cable size is calculated so that a bundle of three cables can bear the rated current at an ambient temperature of 40°C. Table 7.3 lists the type of cables.

### 7 3 1 Rated Current and Cable Size (Cont'd)

Table 7 1 Rated Current

External Terminal	Type CACR Symbol	Rated Current A (Effective Current)									
		SR 03BZ	SR 05BZ	SR 07BZ	SR 10BZ	SR 15BZ	SR 20BZ	SR 30BZ	SR 44BZ	SR 60BZ	
On Line: Main Circuit Power Input	R S T	2	5	6	8	10	12	18	24	32	
Motor Connection	U V W	3.0	4.2	5.8	7.6	11.7	18.8	26.0	33.0	45.0	
Control Power Input	r t	0.5A									
Off Line: Control I/O Signal Connector	1CN	100mA DC max									
PG Signal Connector	2CN	100mA max (500mA DC for power line only)									
Ground	⏚										

Table 7 2 Recommended Cable Size of Servopack

External Terminal	Type CACR Symbol	Cable Size mm <sup>2</sup>									
		SR 03BZ	SR 05BZ	SR 07BZ	SR 10BZ	SR 15BZ	SR 20BZ	SR 30BZ	SR 44BZ	SR 60BZ	
On Line: Main Circuit Power Input	R S T	HIV 2.0 or more			HIV 3.5 or more			HIV 5.5 or more	HIV 5.5 or more	HIV 8.0 or more	
Motor Connection	U V W	HIV 2.0 or more			HIV 3.5 or more						
Control Power Input	r t	HIV 1.25 or more									
Off Line: Control I/O Signal Connector	1CN	<ul style="list-style-type: none"> <li>Two-core twisted shielded cable</li> <li>Core must be 0.2 mm<sup>2</sup> or more</li> <li>Tin-plated soft-copper twisted cable</li> <li>Finished cable dimension 16 dia or less for 1CN</li> <li>11 dia or less for 2CN</li> </ul>									
PG Signal Connector	2CN										
Ground	⏚	HIV 2.0 or more									

Table 7 3 Cable

Type of Lead	Allowable Conductor Temperature
Vinyl Cable (PVC)	—
600 V Vinyl Cable (IV)	60
Special Heat-Resistant Cable (HIV)	75

Note

- For main circuits, use cables of 600 V or more
- Where cables are bundled or run through a duct (unplasticized polyvinyl chloride conduit or metallic conduit) select the larger cable size than listed considering the current drop rate of the cables
- Where the ambient (panel inside) temperature is high (40°C to 60°C), use heat-resistant cables

### 7.3 2 Wiring Precautions

Servopack is a device for speed control of 3000:1, and signal level of several milli-volts or less. The following precautions should be taken for wiring.

(1) For signal lines and PG feedback lines, use twisted cables or multi-core shielded twisted-pair cables (Yaskawa Drawing No. DP8409123 or DE8400093).

Cable length is a maximum of 3 m for reference input lines and a maximum of 20 m for PG feedback lines. Use the shortest possible length.

(2) For ground line, cable should be as heavy as possible to provide class 3 ground (ground resistance 100 Ω or less). Make sure to ground at one point. If the motor and machine are insulated, ground the motor.

(3) To prevent malfunction due to noise, take the following precautions:

- Place the noise filter, Servopack and I/O reference as near as possible to each other.
- Make sure to insert a surge absorbing circuit into the relay, electromagnetic contact, and solenoid coils.
- Run the power line and signal line, holding the distance to 30 cm or more; do not run them in the same duct or in a bundle.
- When the same power is used for Servopack, as for an electric welder or electrical discharge machine or when a high-frequency noise source is present in the vicinity, use filters in the power and input circuits.
- The Servopack uses a switching amplifier, and spurious noise may be present in the signal line. Never leave the termination of the analog input wiring open.

### (4) Remedy for Radio Frequency Interference (R.F.I)

Servopack is not provided with protected from radio frequency interference. If the controller is adversely affected by radio waves, connect a noise filter to power supply.

(5) The signal line uses cables whose core is extremely fine (0.2 to 0.3 mm<sup>2</sup>). Avoid using excessive force which may damage these cables.

### 7 3 3 Power Loss

The power loss of Servopack is shown in Table 7.4.

Table 7 4 Power Loss at Rated Output

Servopack Type CACR-	Output Current A	Power Loss			
		Main Circuit W	Regenerative Resistance W	Control Circuit W	Total W
SR03BZ	3.0	20	10	60	90
SR05BZ	4.2	40			110
SR07BZ	5.3	60			140
SR10BZ	7.6	70	20		150
SR15BZ	11.7	80			160
SR20BZ	18.8	100	40		200
SR30BZ	26.0	160	80		300
SR44BZ	33.0	210	100		370
SR60BZ	45.0	300	120		480

Note The regenerative resistor causes power loss when the motor is decelerated, but is negligible if the motor is not started and stopped frequently

## 8. DIMENSIONS in mm (inches)

### 8.1 SERVOMOTOR: M SERIES

**Drawing 1**  
(Taper Shaft)

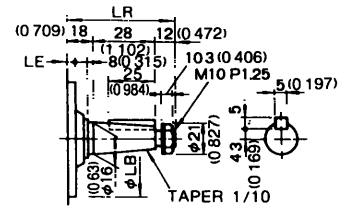
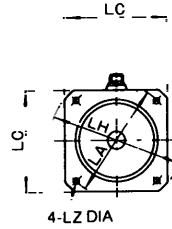
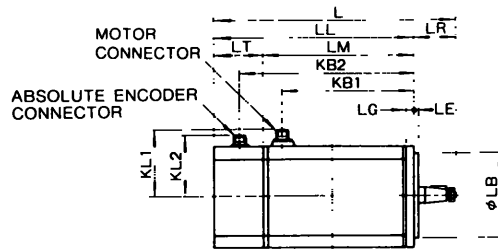

Detail of Shaft Extension

**Drawing 2**  
(Straight Shaft)

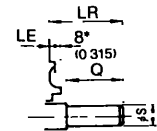
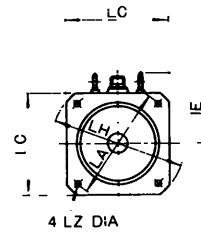
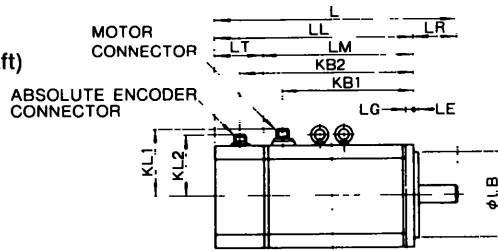

\* Only for USAMED-09MS2

Detail of Shaft Extension

**Drawing 3** • USAMKD-60MS2 (6.0 kW)

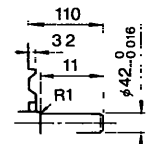
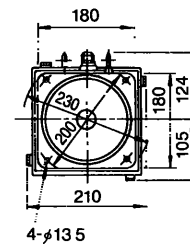
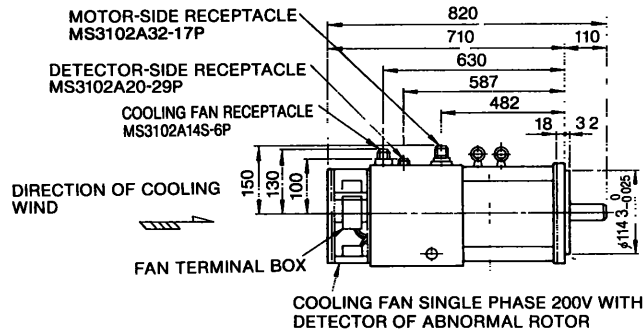

Detail of Shaft Extension

Approx Weight 75kg

### 8.1 SERVOMOTOR: M SERIES (Cont'd)

AC Servomotor Type USAMED	Dwg No	L	LL	LM	LR	LT	KB1	KB2	IE	KL1	KL2	Flange Surface							Shaft Extension		Approx Mass kg (lb)				
												LA	LB	LC	LE	LG	LH	LZ	S	Q					
03MS1	1	286 (11.259)	228 (8.976)	182 (7.165)		46 (1.811)	124 (4.882)	201 (7.913)													See Drawing 1	10 (22)			
06MS1	1	343 (13.524)	285 (11.225)	239 (9.409)	58 (2.283)		181 (7.126)	258 (10.157)		112 (4.439)	93 (3.661)	145 (5.709)	110 (4.331)	130 (5.118)	6 (0.236)	12 (0.472)	165 (6.496)	9 (0.354)				15 (33)			
09MS2*	2	424 (16.693)	366 (14.409)	308 (12.126)			247 (9.724)	339 (13.346)													22 (0.866)	40 (1.575)	21 (46)		
12MS2*	2	355 (13.976)	276 (10.866)	218 (8.583)			171 (6.732)	237 (9.331)															24 (53)		
20MS2	2	413 (16.260)	334 (13.150)	276 (10.867)	79 (3.110)	58 (2.283)	229 (9.016)	295 (11.614)		137 (5.394)													32 (71)		
30MS2	2	498 (19.606)	419 (16.496)	361 (14.213)			314 (12.362)	380 (14.960)	124 (4.882)		110 (4.331)	200 (7.874)	110 (4.331)	130 (5.118)	32 (1.259)	18 (0.709)	230 (9.055)	135 (5.315)				35 (1.378)	76 (2.992)	43 (95)	
44MS2	2	725 (28.543)	615 (24.212)	557 (21.929)	110 (4.331)		482 (18.976)	587 (23.110)		150 (5.905)													42 (1.654)	110 (4.331)	70 (154)

AC Servomotor Type USAMED	Receptacle Type		Mechanical Specification		
	Motor Side	Detector Side	Shaft Runout *	Flange Surface Perpendicular to Shaft *	Flange Dia Concentric to Shaft *
03MS1					
06MS1	MS3102A 18-10P				
09MS2*		MS3102A 20-29P	0.02 (0.0008)	0.04 (0.0016)	0.04 (0.0016)
12MS2*					
20MS2	MS3102A 22-22P				
30MS2					
44MS2	MS3102A 32-17P				
60MS2	MS3102A 32-17A	MS3102A 20-29P	0.04 (0.0016)		

- \* Not provided with an eyebolt
- \* TIR Total Indicator Reading
- Note 1 Absolute encoder is used as a detector
- 2 Vibration 15/μm or below
- 3 Plug and clamp are not attached for receptacle connection
- 4 Connector specifications

Motor receptacle      Detector receptacle



A	Phase U
B	Phase V
C	Phase W
D	Ground

A	Channel A output	K	—
B	Channel A output	L	—
C	Channel B output	M	—
D	Channel B output	N	—
E	Channel Z output	P	—
F	Channel Z output	R	For reset
G	0V	S	0V (battery)
H	+5VDC	T	3V (battery)
J	Frame ground	—	—





## 8.2 SERVOMOTOR: F SERIES (Cont'd)

AC Servomotor Type USAFED-	Dwg No	L	LL	LM	LR	LT	KB1	KB2	IE	KL1	KL2	Flange Surface						Shaft Extension		Approx Mass kg (lb)	
												LA	LB	LC	LE	LG	LH	LZ	S		Q
02FS1	1	234 (9.213)	197 (7.756)	137 (5.394)	37 (1.457)	60 (2.362)	89.5 (3.524)	172 (6.772)		76 (2.992)	87 (3.425)	100 (3.937)	83.5 (3.285)	90 (3.543)	4 (0.155)	7 (0.276)	120 (4.724)	6.6 (0.260)	See Drawing 1		5 (11)
03FS1	1	280 (11.024)	243 (9.567)	183 (7.205)				218 (8.583)													5.5 (12)
05FS1	2	286 (11.259)	228 (8.976)	182 (7.165)		46 (1.811)		124 (4.882)	201 (7.913)										See Drawing 2		10 (22)
09FS1	2	343 (13.524)	285 (11.220)	239 (9.409)	58 (2.283)			181 (7.126)	258 (10.157)		112 (4.409)	93 (3.661)	145 (5.709)	110 (4.331)	6 (0.236)	12 (0.472)	165 (6.493)	9 (0.354)			15 (33)
13FS2*	3	424 (16.693)	366 (14.409)	308 (12.126)				247 (9.724)	339 (13.346)												22 (8.66)
20FS2*	3	355 (13.976)	276 (10.866)	218 (8.583)		58 (2.283)		171 (6.732)	237 (9.331)												40 (15.75)
30FS2	3	413 (16.260)	334 (13.150)	276 (10.866)	79 (3.113)			229 (9.016)	295 (11.614)	124 (4.882)	137 (5.394)	110 (4.331)	200 (7.874)	143 (5.630)	3.2 (0.126)	18 (0.709)	230 (9.055)	13.5 (0.531)			35 (13.78)
44FS2	3	498 (19.606)	419 (16.496)	361 (14.213)				314 (12.352)	380 (14.925)												76 (29.92)

AC Servomotor Type USAFED-	Receptacle Type		Mechanical Specifications		
	Motor Side	Detector Side	Shaft Runout*	Flange Surface Perpendicular to Shaft*	Flange Dia Concentric to Shaft*
02FS1	MS3102A 14S-2P				
03FS1					
05FS1	MS3102A 18-10P				
09FS2		MS3102A 20-29P	0.02 (0.0008)	0.04 (0.0016)	0.04 (0.0016)
13FS2*					
20FS2*	MS3102A 22-22P				
30FS2					
44FS2					

### 4 Connector specifications

#### Motor receptacle

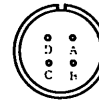

A	Phase U
B	Phase V
C	Phase W
D	Frame ground

#### Detector receptacle



A	Channel A output	K	—
B	Channel A output	L	—
C	Channel B output	M	—
D	Channel B output	N	—
E	Channel Z output	P	—
F	Channel Z output	R	For reset
G	0V	S	0V(battery)
H	+5VDC	T	3V(battery)
J	Frame ground	—	—

\* Not provided with an eyebolt

+ TIR Total Indicator Reading

Note 1 Absolute encoder is used as a detector

2 Vibration 15µm or below

3 Plug and clamp are not attached for receptacle connection

### 8.3 SERVOMOTOR: S SERIES

#### Drawing 1

(Straight Shaft)

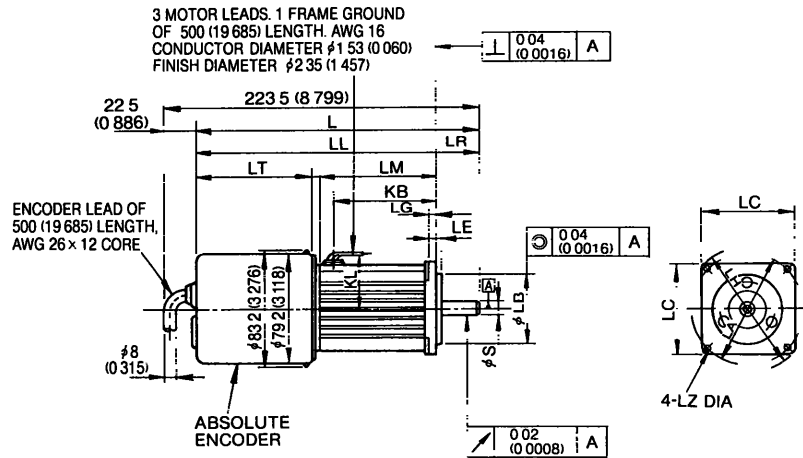

#### Drawing 2

(Straight Shaft)

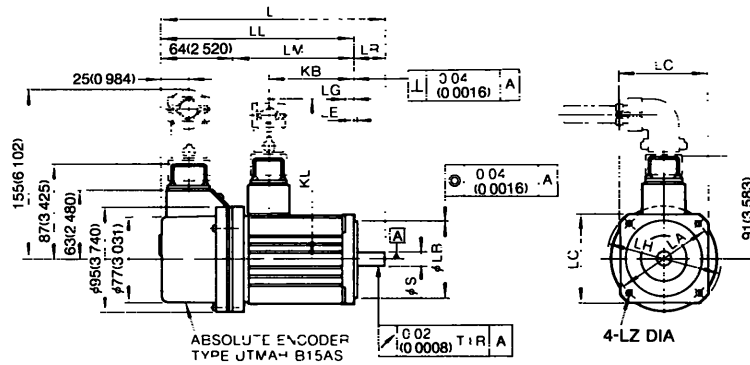

#### Drawing 3

(Taper Shaft)

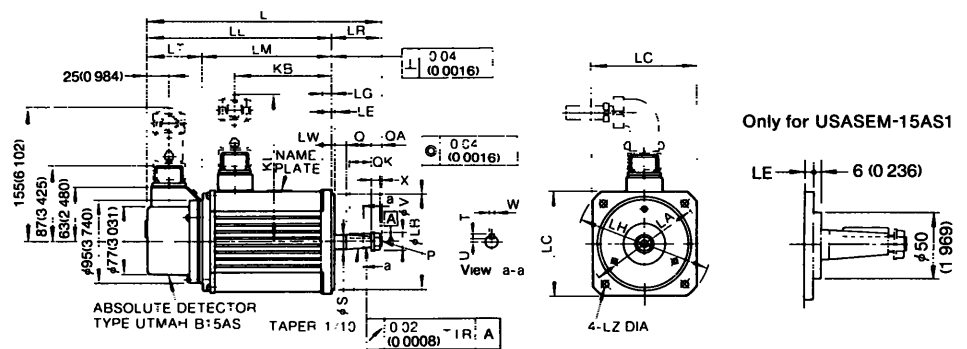

### 8.3 SERVOMOTOR: S SERIES (Cont'd)

AC Servomotor Type USASEM-	Dwg No	L	LL	LM	LR	LT	KB	KL	Flange Surface							Receptacle Type		Approx Mass kg (lb)
									LA	LB	LC	LE	LG	LH	LZ	Motor Side	Detector Side	
02AS2	1	201 (7913)	171 (6732)	83 (32675)	30 (1181)	83 (32675)	72.5 (2854)	41 (1614)	80 (3150)	50 <sup>0</sup> <sub>-0.025</sub> (1969 <sup>0</sup> <sub>-0.00098</sub> )	65 (2559)	3 (0118)	6 (0236)	90 (3543)	5 (0197)	-	-	1.5 (3.31)
03AS2	2	208 (8150)	178 (7008)	114 (4488)	30 (1181)	-	79 (3110)	145 (5708)	90 (3543)	70 <sup>0</sup> <sub>-0.030</sub> (2756 <sup>0</sup> <sub>-0.00119</sub> )	80 (3150)	3 (0118)	8 (0315)	105 (4134)	6 (0236)	MS3102A 18-10P	-	3.2 (7.05)
05AS2	2	230 (9055)	200 (7874)	136 (5354)	-	-	101 (3976)	-	-	-	-	-	-	-	-	-	-	3.8 (8.37)
08AS2	3	274 (10787)	216 (8504)	152 (5984)	58 (2283)	-	115 (4527)	170 (6693)	130 (5118)	110 <sup>0</sup> <sub>-0.035</sub> (43308 <sup>0</sup> <sub>-0.00138</sub> )	120 (4724)	3 (0118)	10 (0394)	155 (61)	9 (0354)	MS3102A 20-20P	-	6.3 (13.89)
15AS1	3	325.5 (12815)	267.5 (10532)	203.5 (8012)	64 (2520)	-	166.5 (6555)	177 (6969)	145 (5708)	-	130 (5118)	6 (0236)	12 (0472)	165 (6496)	-	MS3102A 20-4P	-	11.5 (25.35)
30AS1	3	374 (14724)	304 (11969)	240 (9449)	70 (2756)	-	206 (8110)	205 (8071)	200 (7874)	114.3 <sup>0</sup> <sub>-0.042</sub> (45 <sup>0</sup> <sub>-0.00157</sub> )	180 (7087)	6 (0236)	18 (0708)	230 (9055)	13.5 (0531)	-	-	24.5 (54.01)

AC Servomotor Type USASEM-	Dwg No	Shaft Extension										
		LW	Q	QK	QA	X	S	V	P	U	W	T
02AS2	1	-	-	-	-	-	8 <sup>0</sup> <sub>-0.009</sub> (0315 <sup>0</sup> <sub>-0.00025</sub> )	-	-	-	-	-
03AS2	2	-	-	-	-	-	14 <sup>0</sup> <sub>-0.01</sub> (0551 <sup>0</sup> <sub>-0.00043</sub> )	-	-	-	-	-
05AS2	2	-	-	-	-	-	-	-	-	-	-	-
08AS2	3	18 (0709)	28 (1102)	25 (0984)	12 (0472)	10.3 (0406)	16 (0630)	21 (0827)	M10 P1 25	43 <sup>0</sup> <sub>-0.1</sub> (01693 <sup>0</sup> <sub>-0.0039</sub> )	5 (01968)	5 (01968)
15AS1	3	-	-	-	-	-	19 (0748)	-	-	58 <sup>0</sup> <sub>-0.1</sub> (02283 <sup>0</sup> <sub>-0.0039</sub> )	-	-
30AS1	3	20 (0788)	36 (1417)	32 (1259)	14 (0551)	12.5 (0492)	22 (0866)	24 (0945)	M12 P1 25	66 <sup>0</sup> <sub>-0.1</sub> (02598 <sup>0</sup> <sub>-0.0039</sub> )	6 (02362)	6 (02362)

- Note**  
 1 Drawout construction of Type USASEM-02AE20B is waterproof gland method  
 For details, request another dimensions to your Yaskawa representative  
 2 Absolute encoder is used as a detector  
 3 Vibration 15 μm or below  
 4 Plug and clamp are not attached for receptacle connection  
 5 Connector specifications

- Motor receptacle



A	Phase U
B	Phase V
C	Phase W
D	Ground

- Detector receptacle



A	Channel A output	K	-
B	Channel A output	L	-
C	Channel B output	M	-
D	Channel B output	N	-
E	Channel Z output	P	-
F	Channel Z output	R	For reset
G	0V	S	0V (battery)
H	+5VDC	T	3V (battery)
J	Frame ground	-	-

## 8.4 Servopack

(1) Types CACR-SR03BZ to -SR15BZ

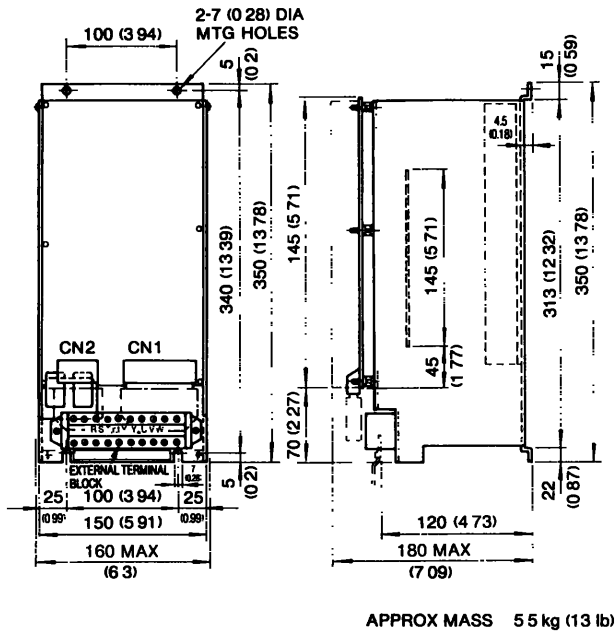

(3) Types CACR-SR44BZ

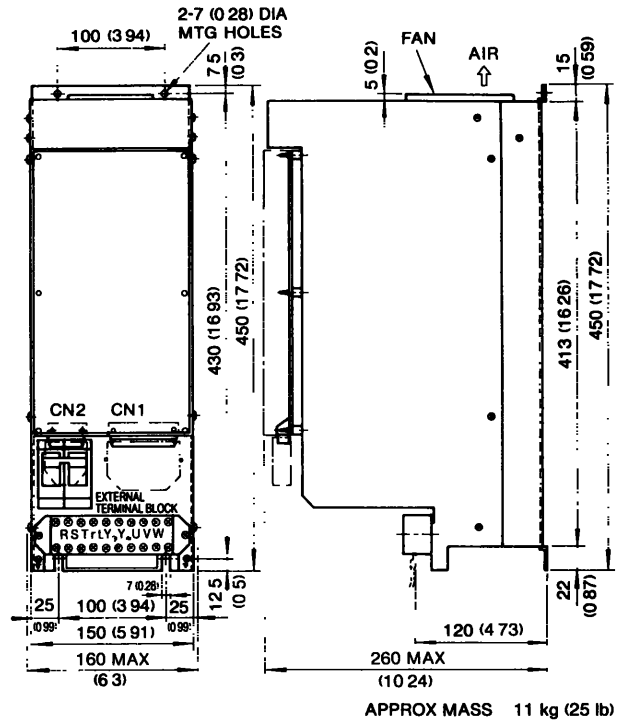

(2) Types CACR-SR20BZ to -SR30BZ

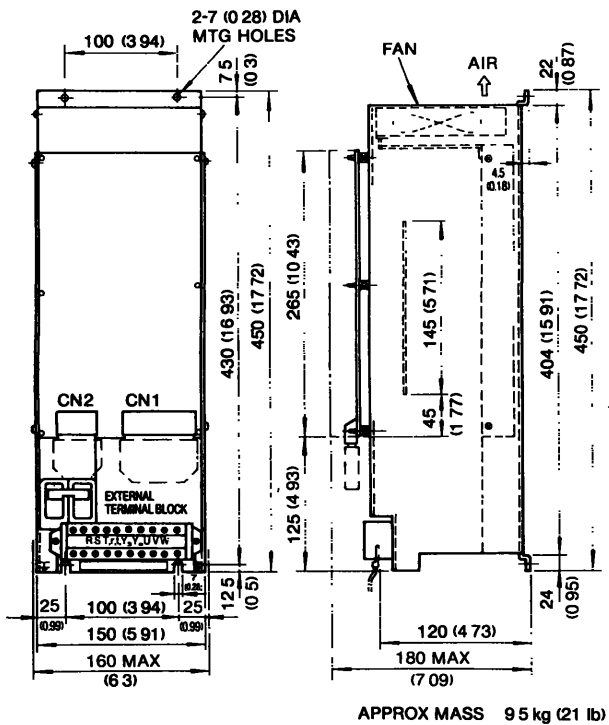

(4) Type CACR-SR60BZ

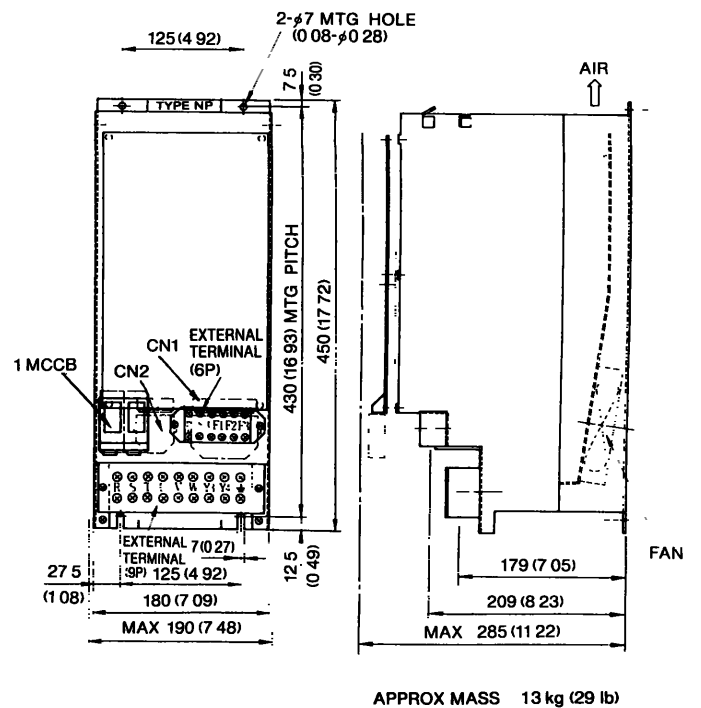

## 9. TEST RUN

Before test run, check the following. Correct any deficiency.

### 9.1 CHECK ITEMS BEFORE TEST RUN

#### 9.1.1 AC Servomotor

Before test run, check the following. If the test run is performed after long storage, see Par. 11. Inspection and Maintenance.

- Connection to machines or devices, wiring, fuse connection, and grounding are correct.
- Bolts and nuts are not loose.
- For motors with oil seals, the seals are not damaged and oil is properly lubricated.

#### 9.1.2 Servopack

- Setting switches are correctly set to satisfy the specifications for the applicable servomotor.
- Connection and wiring leads are firmly connected to terminals or inserted into the connectors.
- The power supply is turned off if servo alarm outputs.
- Voltage supplied to Servopack is 200 to 230V  $\pm 10\%$   $-15\%$ . (If a voltage line other than 200V is used, the voltage should be dropped to 200V through a power transformer.)
- The speed reference should be 0V (speed reference circuit is short-circuited.)

## 9.2 TEST RUN PROCEDURES

### 9.2.1 Preparation of Operation

During test run, loads should not be applied to the servomotor. If it is necessary to start with the driven machine connected to the motor, confirm that the driven system has been ready for emergency stop at any time.

#### (1) Power ON

- After checking items in Par. 9.1, turn on the power supply. When the power on sequence is correct, according to Par. 6.1, the power is turned on by pressing the POWER pushbutton for approximately 1 second.
- When the power is correctly supplied, the following green LED's light: **P** and **MP**.

- When a Servo ON signal is input (contact is on), the power circuit in the Servopack operates and the motor is ready to run.

### 9.2.2 Operation

The operation is possible only while Servo ON signal is on.

- Increase the speed reference voltage gradually from 0 V, then the motor will rotate at a speed proportional to the reference voltage.
- When the reference voltage is positive, the motor rotates forward (counterclockwise viewed from drive end—output shaft) (Fig. 9.1).

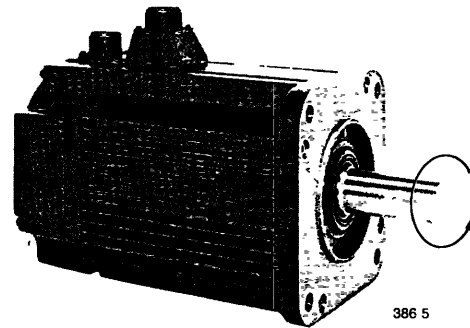

Fig 9.1 Motor Forward Running

### 9.2.3 Inspection during Test Run

The following items should be checked during the test run.

- Unusual vibration
- Abnormal noise
- Excessive temperature rise

If any abnormality is found, take corrective actions according to Par. 12. At a test operation, the load and machine may not fit well at first and result in overload.

### 9.2.4 Setup of Absolute Encoder

With the absolute encoder providing to the machine, the machine original point, that is, standard position must be set to absolute encoder. This operation is called setup. For setup methods, refer to Par. 6.4.3(8).

# 10. ADJUSTMENT

## 10.1 SETTINGS AT THE TIME OF DELIVERY

The Servopack has been factory-adjusted as follows:

(1) M series

Table 10 1 Standard Adjustment and Setting Specifications

Servopack Type CACR-	Applicable Servomotor		Servopack Adjustment		
	Type USAMED-	Rated Current * A	Speed Setting	Starting Current Setting* A	Output Pulse Setting
SR03BZ1SM	03MS1	30	1000 r/min at rated speed reference	7.3	6000 P/R
SR07BZ1SM	06MS1	58		13.9	
SR10BZ1SM	09MS2	76		16.6	
SR15BZ1SM	12MS2	117		28.0	
SR20BZ1SM	20MS2	188		42.0	
SR30BZ1SM	30MS2	260		56.5	
SR44BZ1SM	44MS2	330		70.0	
SR60BZ1SM	60MS2	95.0		80.6	

\* Effective value

Table 10 2 Standard Factory-adjusted Switch Positions

Servopack Type CACR-	SW1	SW2	SW3	SW4
	Motor Type	Output Pulse Setting	Speed Loop Condition Setting	Motor Characteristics, Servopack Function Setting
SR03BZ1SM to SR44BZ1SM	<p>1 2 3 4 5 6 7 8</p>	<p>6000 P/R</p> <p>1 2 3 4 5 6 7 8 †</p>	<p>1 2 3 4 5 6 7 8</p>	<p>1 2 3 4 5 6 7 8 †</p>

† Spare short-circuit pin

Table 10 3 Standard Factory-adjusted Potentiometers

Servopack Type CACR-	Auxiliary Input Setting	Auxiliary Input Fine Setting	Zero Drift Setting	Max Current Setting	Loop Gain Setting
	VR1 <span style="border: 1px solid black; padding: 2px;">IN-B</span>	VR4	VR3 <span style="border: 1px solid black; padding: 2px;">ZERO</span>	VR5 <span style="border: 1px solid black; padding: 2px;">CUR</span>	VR6 <span style="border: 1px solid black; padding: 2px;">LOOP</span>
SR03BZ1SM SR07BZ1SM SR10BZ1SM SR15BZ1SM SR20BZ1SM SR30BZ1SM SR44BZ1SM SR60BZ1SM	10V at rated speed (For setting by the user)	5/10	4/10 to 6/10	10/10 (For setting by the user)	5/10

Note

1 In the Table above, shows approximate scale of potentiometer

For example, indicates 7/10 scale

2 The potentiometers other than listed in the Table above are provided for the Servopack. Do not tamper with these potentiometers except for a special case as they have been preset at the factory

## 10.1 SETTING AT THE TIME OF DELIVERY (Cont'd)

(2) F series

Table 10 4 Standard Adjustment and Setting Specifications

Servopack Type CACR-	Applicable Servomotor		Servopack Adjustment		
	Type USAFED-	Rated Current* A	Speed Setting	Starting Current Setting* A	Output Pulse Setting
SR03BZ1SF	02FS1, 03FS1	3.0	1500 r/min at rated speed reference	8.5	6000 P/R
SR05BZ1SF	05FS1	3.8		11.0	
SR10BZ1SF	09FS1	6.2		17.0	
SR15BZ1SF	13FS2	9.7		27.6	
SR20BZ1SF	20FS2	15.0		42.0	
SR30BZ1SF	30FS2	20.0		56.5	
SR44BZ1SF	44FS2	30.0		77.0	

\* Effective value

Table 10 5 Standard Factory-adjusted Switch Positions

Servopack Type CACR-	SW1	SW2	SW3	SW4
	Motor Type	Output Pulse Setting	Speed Loop Condition Setting	Motor Characteristics, Servopack Function Setting
SR03BZ1SF to SR44BZ1SF		6000 P/R 		

\* Spare short-circuit pin

Table 10 6 Standard Factory-adjusted Potentiometers

Servopack Type CACR-	Auxiliary Input Setting	Auxiliary Input Fine Setting	Zero Drift Setting	Max Current Setting	Loop Gain Setting
	VR1 <span style="border: 1px solid black; padding: 2px;">IN-B</span>	VR4	VR3 <span style="border: 1px solid black; padding: 2px;">ZERO</span>	VR5 <span style="border: 1px solid black; padding: 2px;">CUR</span>	VR6 <span style="border: 1px solid black; padding: 2px;">LOOP</span>
SR03BZ1SF	10 V at rated speed (For setting by the user)	5/10	4/10 to 6/10	10/10 (For setting by the user)	5/10
SR05BZ1SF					
SR10BZ1SF					
SR15BZ1SF					
SR20BZ1SF					
SR30BZ1SF					
SR44BZ1SF					

Note

1 In the Table above, shows approximate scale of potentiometer

For example, indicates 7/10 scale

2 The potentiometers other than listed in the Table above are provided for the Servopack. Do not tamper with these potentiometers except for a special case as they have been preset at the factory



(3) S series

Table 10 7 Standard Adjustment and Setting Specifications

Servopack Type CACR-	Applicable Servomotor		Servopack Adjustment		
	Type USASEM-	Rated Current* A	Speed Setting	Starting Current Setting* A	Output Pulse Setting
SR03BZ1SS-Y41	02AS2	2 1	3000 r/min at rated speed reference	6 0	6000 P/R
SR03BZ1SS	03AS	3 0		8 5	
SR05BZ1SS	05AS	4 2		11 0	
SR10BZ1SS	08AS	5 3		15 6	
SR15BZ1SS	15AS	10 4		28 0	
SR30BZ1SS	30AS	19 9		56 5	

\* Effective value

Table 10 8 Standard Factory-adjusted Switch Positions

Servopack Type CACR-	SW1	SW2	SW3	SW4
	Motor Type	Output Pulse Setting	Speed Loop Condition Setting	Motor Characteristics, Servopack Function Setting
SR03BZ1SS-Y41 to SR30BZ1SS		6000 P/R 	SR10BZ, SR15BZ  SR03BZ, SR05BZ, SR30BZ 	

† Spare short-circuit pin

Table 10 9 Standard Factory-adjusted Switch Positions

Servopack Type CACR-	Auxiliary Input Setting	Auxiliary Input Fine Setting	Zero Drift Setting	Max Current Setting	Loop Gain Setting
	VR1	VR4	VR3	VR5	VR6
SR03BZ1SS-Y41	10 V at rated speed (For setting by the user)	5/10	4/10 to 6/10	10/10 (For setting by the user)	5/10
SR03BZ1SS					
SR05BZ1SS					
SR10BZ1SS					
SR15BZ1SS					
SR30BZ1SS					

Note

1 In the Table above, shows approximate scale of potentiometer

For example, indicates 7/10 scale

2 The potentiometers other than listed in the Table above are provided for the Servopack. Do not tamper with these potentiometers except for a special case as they have been preset at the factory

## 10.1 SETTING AT THE TIME OF DELIVERY(Cont'd)

(4) D series

Table 10 10 Standard Adjustment and Setting Specifications

Servopack Type CACR-	Applicable Servomotor		Serkopack Adjustment		
	Type USADED-	Rated Current* A	Speed Setting	Starting Current Setting* A	Output Pulse Setting
SR05BZ1SD	05ES1	3.5	2000 r/min at rated speed reference	10.6	6000 P/R
SR15BZ1SD	10ES2	7.9		25.2	
SR20BZ1SD	15ES2	12.6		40.7	
SR30BZ1SD	22ES2	16.6		54.0	
SR44BZ1SD	37ES2	23.3		77.0	

\* Effective value

Table 10 11 Standard Factory-adjusted Switch Positions

Servopack Type CACR-	SW1	SW2	SW3	SW4
	Motor Type	Output Pulse Setting	Speed Loop Condition Setting	Motor Characteristics, Servopack Function Setting
SR05BZ1SD to SR44BZ1SD	1 2 3 4 5 6 7 8 	6000 P/R 1 2 3 4 5 6 7 8† 	1 2 3 4 5 6 7 8 	1 2 3 4 5 6 7 8† 

† Spare short-circuit pin

Table 10 12 Standard Factory-adjusted Potentiometers

Servopack Type CACR-	Auxiliary Input Setting	Auxiliary Input Fine Setting	Zero Drift Setting	Max Current Setting	Loop Gain Setting
	VR1  IN-B	VR4	VR3  ZERO	VR5  CUR	VR6  LOOP
SR05BZ1SD	10 V at rated speed (For setting by the user)	5/10	4/10 to 6/10	10/10 (For setting by the user)	5/10
SR15BZ1SD					
SR20BZ1SD					
SR30BZ1SD					
SR44BZ1SD					

Note

1 In the Table above, shows approximate scale of potentiometer,

For example indicates 7/10 scale

2 The potentiometers other than listed in the Table above are provided for the Servopack. Do not tamper with these potentiometers except for a special case as they have been preset at the factory

## 10.2 CHARACTERISTICS AT THE TIME OF DELIVERY

The Servopack has been factory-adjusted as follows:

(1) Speed reference input—servomotor speed ratio (no load) (Fig. 10.1)

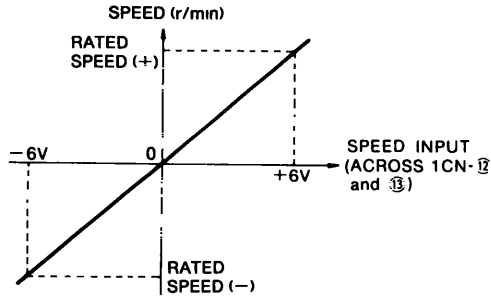

Fig 10 1 Speed Reference Input—Servomotor Speed Ratio

(2) Speed Variation (Fig. 10.2)

Speed variation  $\Delta N$ ,  $\Delta n$ :

$$\frac{\Delta N}{N_R} \times 100\% \leq 0.03\%$$

$$\frac{\Delta n}{N_R} \times 100\% \leq 0.015\%$$

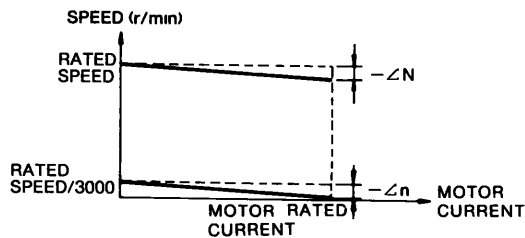

Fig 10 2 Speed Variation

(3) Start—stop characteristics (Fig. 10.3)

$I_p$ : Start current set value in Tables 10.1, 10.4, 10.7. The overshoot ( $\Delta N_{ov}$ ) and undershoot ( $\Delta N_{ud}$ ) when  $J_L = J_M$ , are as shown in Table 10.13 (adjustment level preset at the factory).

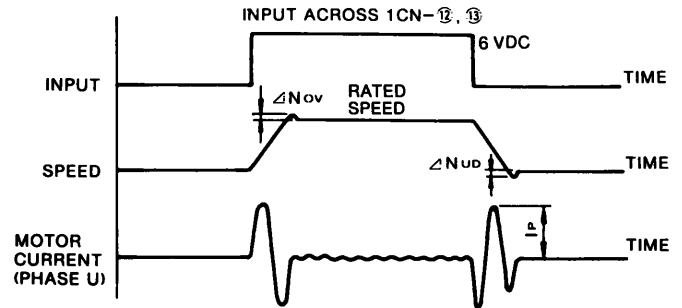

Fig 10 3 Start—Stop Characteristics

Table 10 13 Overshoot and Undershoot at Step Response

Type CACR-	$\Delta N_{ov}/N_R \times 100$	$\Delta N_{ud}/N_R \times 100$
SR03BZ	5 % max	5 % max
SR05BZ		
SR07BZ		
SR10BZ		
SR20BZ		
SR30BZ		
SR44BZ		
SR60BZ		

## 10.3 READJUSTMENT

The Servopack has been adjusted at the factory to obtain optimum characteristics, and readjustment is normally unnecessary. If adjustment is required depending on the use, readjust the Servopack referring to Table 10.14 (Do not tamper with potentiometers.)

## 10. 4 ADJUSTMENT PROCEDURES

Fig. 10. 4 shows the arrangement of potentiometers, and terminals for checking waveforms; Table 10.14 shows the specifications of the check pin (CH); and Table 10.15 lists check terminals and functions.

Adjust the potentiometers, observing the specified check locations. (Potentiometers should not be tampered with.) Fig. 10.5 shows waveforms at the respective check terminals for step responses at no load.

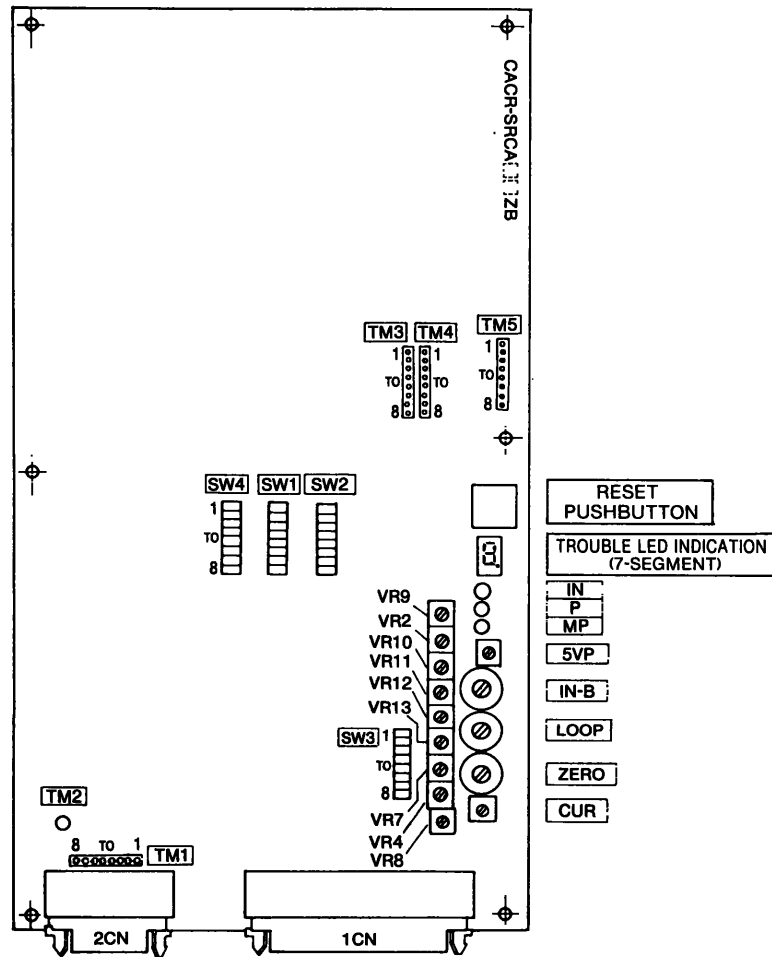
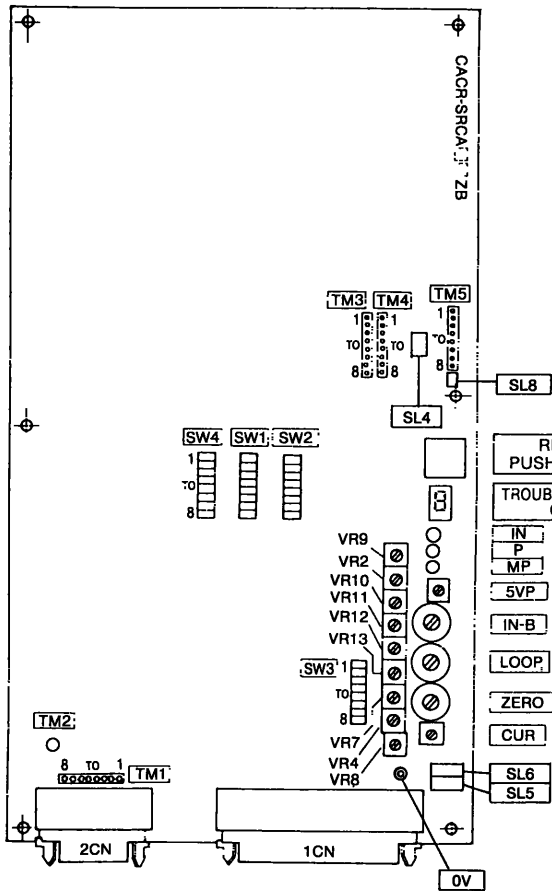

Fig 10 4 (a) Arrangement of Potentiometers (VR), Check Terminals, and Switches (SW) for Servopack Type CACR-SRCA□□ZB REV B



**SL4, SL5** Select switches should not be adjusted except in special cases  
**SL6** Do not adjust

**Fig 10.4 (b) Arrangement of Potentiometers (VR), Check Terminals, Select Switches (SL), and Switches (SW) for Servopack Type CACR-SRCA ZB REV E**

**SL4, SL5** Select switches should not be adjusted except in special cases  
**SL6, SL8** Do not adjust

**Fig 10.4 (c) Arrangement of Potentiometers (VR), Check Terminals, Select Switches (SL), and Switches (SW) for Servopack Type CACR-SRCA ZB REV C**

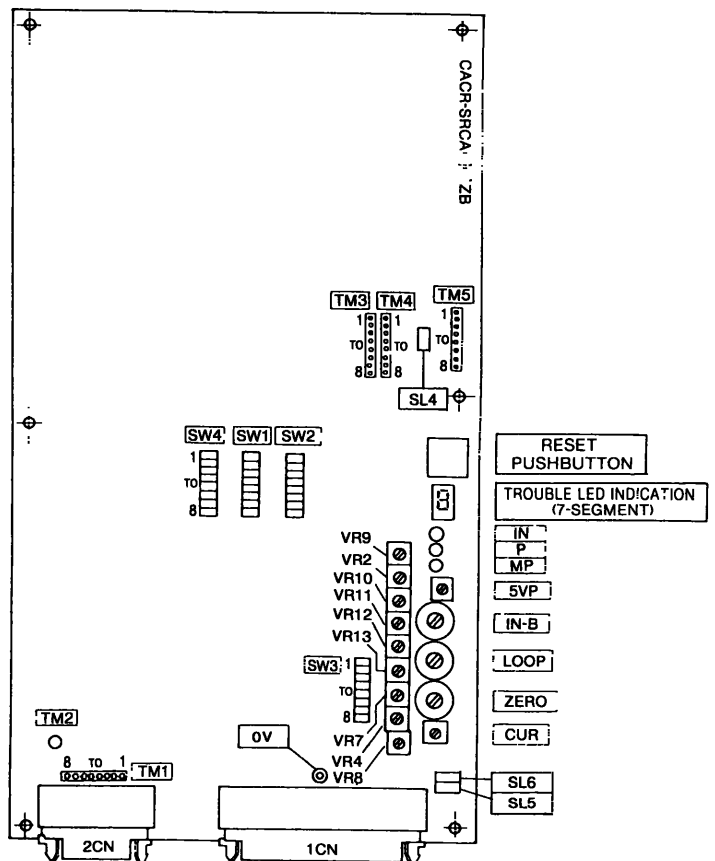

### 10.4 ADJUSTMENT PROCEDURES (Cont'd)

Table 10 14 Potentiometer Adjustment

Potentiometer	VR1 <b>IN-B</b>	VR4	VR3 <b>ZERO</b>	VR5 <b>CUR</b>
Functions	Auxiliary input adjustment	Auxiliary input fine adjustment	Zero drift adjustment	Starting current adjustment
How to Adjust	To be adjusted only when the rated reference voltage ( $\pm 2$ to $\pm 10V$ ) is other than $\pm 6V$ . Turn VR1 only to get the rated speed and do not operate other VRs	To fine adjust the adjusted value of VR1	To adjust so that the motor does not turn at the speed reference voltage 0 V. Turning VR3 CW allows the motor to be finely adjusted in forward rotation, and CCW in reverse rotation	Turning VR5 CCW decreases the starting current. This has been adjusted to full scale CCW at the factory
Characteristics	<p>Adjustable in units of 1/10 of VR1 setting</p>			
Adjustment	○	○	○	○
Potentiometer	VR6 <b>LOOP</b>	VR2	VR9	VR10
Functions	Speed loop gain adjustment	f/V gain adjustment	f/V zero adjustment	f/V balance adjustment
How to Adjust	To increase gain, turn VR6 CW	Turning CW increases feedback voltage	f/V circuit offset adjustment	f/V circuit $\pm$ output voltage balance adjustment
Characteristics	Turn VR6 CCW to prevent hunting	Turning CW decreases motor speed	—	If f/V balance adjustment is not correct, motor does not run at the same speed in both directions under the same absolute reference voltage
Adjustment	○	x	—	x
Potentiometer	VR7	VR8	—	—
Functions	Torque reference adjustment	Max current adjustment	—	—
How to Adjust	Adjust to rated current at 3V	Set max current depending on types and motor output (Turn VR5 CW to full scale)	—	—
Characteristics	—	Turning CW increases max current	—	—
Adjustment	x	x	—	—
Potentiometer	VR11	VR12	VR13	VR21
Function	Phase U current offset adjustment	Phase V current offset adjustment	Phase W current offset adjustment	Absolute encoder 5V voltage adjustment
How to Adjust	With only control power turned on, adjust until phase U current amplifier output voltage becomes minimum	With only control power turned on, adjust until phase V current amplifier output voltage becomes minimum	With only control power turned on, adjust until phase W current amplifier output voltage becomes minimum	Absolute encoder power voltage adjustment. It is set to 5.5V at the factory
Characteristics	Incorrect adjustment increases torque ripple			Turning CW increases voltage. If wiring to absolute encoder is long, causing voltage drop, increase voltage
Adjustment	x	x	x	△

Adjustment Directions

Mark ○ Potentiometer should be adjusted in accordance with specifications and application

Mark △ Potentiometer should not be adjusted except in special cases

Mark x Do not adjust

Table 10 15 List of Check Terminals

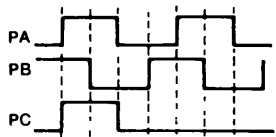
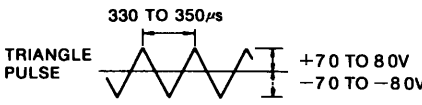
Equipment Symbol	Signal Name	Description																							
TM1	1	PA	Phase A pulse is input																						
	2	* PA	Reverse pulse of phase A is input																						
	3	PB	Phase B pulse is input																						
	4	* PB	Reverse pulse of phase B is input																						
	5	PC	Phase C pulse is input																						
	6	* PC	Reverse pulse of phase C is input																						
	7	—	Unused																						
	8	5VP	Absolute encoder supply voltage +5V																						
		<p>PA and PB are two-phase pulse with 90° phase difference PC occurs once for each motor rotation, in synchronization with PA</p> <p>Waveform at motor forward rotation</p> 																							
TM2	OVP	0V of the absolute encoder power supply (common terminal of signals)																							
TM3	1	IN-A	Monitors the speed reference input (connector 1CN ⑫—⑬)																						
	2	IN-B	Monitors the speed reference auxiliary input (connector 1CN ⑭—⑮)																						
	3	V TG	Monitors the motor speed ±4.0 VDC/±1000 r/min (M, F, D series), ±2.0 VDC/±1000 r/min (S series)																						
	4	T-Mon	Monitors the motor torque ±3.0 VDC/100 %																						
	5	T-Ref	Torque reference ±2.0 to ±3.0 VDC/100 %																						
	6	U-sin	Monitors phase U sin waveform																						
	7	V-sin	Monitors phase V sin waveform																						
	8	SG	Signal 0V (for printed circuit board of REV B), (Blank for printed circuit board of REV C, REV E)																						
TM4	1	IU	Phase U current monitor																						
	2	IV	Phase V current monitor																						
	3	—	Unused																						
	4	AU	Phase U current amplification output monitor																						
	5	AV	Phase V current amplification output monitor																						
	6	AW	Phase W current amplification output monitor																						
	7	OSC2	Carrier frequency (triangle pulse)																						
	8	SG	Signal 0V (for printed circuit board of REV B), (Blank for printed circuit board of REV C, REV E)																						
		<table border="1" style="display: inline-table; vertical-align: middle;"> <thead> <tr> <th>Type</th> <th>CACR-SR</th> <th>03</th> <th>05</th> <th>07</th> <th>10</th> <th>15</th> <th>20</th> <th>30</th> <th>44</th> <th>60</th> </tr> </thead> <tbody> <tr> <td>Monitor Voltage (V/A)</td> <td></td> <td>0.4</td> <td>0.24</td> <td>0.20</td> <td>0.16</td> <td>0.08</td> <td></td> <td></td> <td>0.04</td> <td></td> </tr> </tbody> </table>		Type	CACR-SR	03	05	07	10	15	20	30	44	60	Monitor Voltage (V/A)		0.4	0.24	0.20	0.16	0.08			0.04	
Type	CACR-SR	03	05	07	10	15	20	30	44	60															
Monitor Voltage (V/A)		0.4	0.24	0.20	0.16	0.08			0.04																
																									
OV	Signal 0V for each signal measurement of TM3 and TM4. (for printed circuit board of REV C, REV E)																								

Note

- The check terminals allow oscilloscope connection for measurement
- Measure waveforms of TM3 and TM4 with TM3-8 or TM4-8 (signal 0V) taken as the reference
- TM2 (OVP) are impedance-connected to TM3-8 and TM4-8 (signal 0V)

- During measurement, do not short the adjacent two check terminals, as the connected elements may be destroyed by this
- TM5 check terminal is for use only by the manufacturer. Do not make any measurement with it

## 10.4 ADJUSTMENT PROCEDURES (Cont'd)

Fig 10 5 Waveforms at the Respective Check Terminals for Step Responses (No Load)

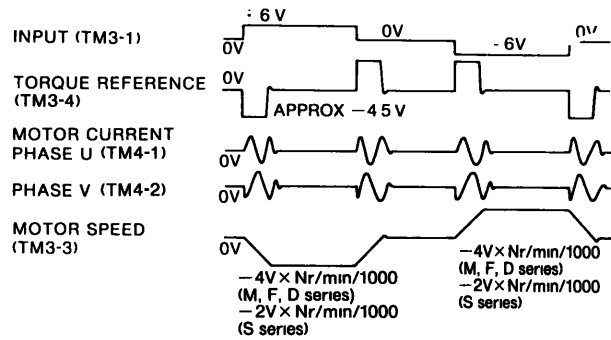

## 10.5 SWITCH SETTING

The four switches (SW1, SW2, SW3, SW4) have the following functions:

Table 10 16 Switch Setting and Function

Switch Name	Function	User Adjustment	Remarks
SW1	Motor type setting Servopack function setting	Possible	See Tables 10 2, 10 5, 10 8, 10 11
SW2	Output pulse setting	Possible	See Table 6 1
SW3	Speed loop condition setting	Possible	See the figure below As a normal rule, leave the setting as it was preset at the factory
SW4	Motor characteristics and Servopack function setting	Never change this setting	The optimized motor torque characteristics and Servopack functions have already been at the factory

Note Function of SW3

1 PI time constant setting (SW3 -1 to -6)

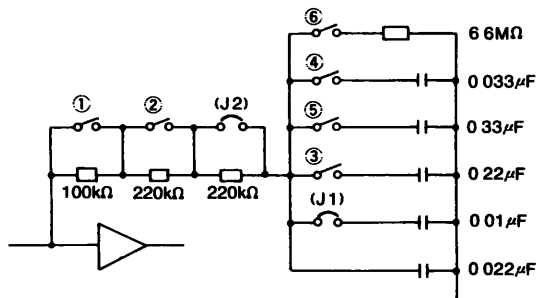

2 f/V filter setting (SW3 -7)

SW3-7	Time Constant
Shorted	1.2 ms
Open	0.1 ms

3 Mode switch setting (SW3 -8)

SW3-8	Mode Switch
Shorted	Not provided
Open	Provided



## 11. INSPECTION AND MAINTENANCE

### 11.1 AC SERVOMOTOR

The AC servomotor has no wearing parts(eg. brushes), so simple daily inspection is sufficient. The inspection schedule for the motor is shown in Table 11.1.

Do not disassemble the motor. If disassembly should become necessary, contact your Yaskawa representative.

Table 11 1 Inspection Schedule for Motors

Inspection Item	Frequency	Inspection Operation
Vibration	Daily	Feel manually
Noise	Daily	Aurally
Exterior and Cleaning	As required	Clean with dry cloth or compressed air
Insulation Resistance	Yearly	Make sure that it is more than 10MΩ by measuring with a 500V megger after disconnecting the motor from the controller
Oil Seal	Every 5000 hours	If worn or damaged, replace after disconnecting the motor from the driven machine
Total Inspection	Every 20,000 hours	Contact Yaskawa representative

### 11.2 Servopack

The Servopack is of contactless construction so that no special maintenance is required. Remove dust and tighten screws periodically.

### 11.3 BATTERY REPLACEMENT METHOD

The life of lithium battery (type BR-C) is approximately 10 years. The battery for absolute encoder (provided by user) is replaced as follows:

- 1.\* After Servopack power is turned on, SEN signal remains at a high-level for 3 minutes minimum. (The capacitor in encoder is charged.)
2. Replace the battery. (Servopack power may be turned off or on.)

The encoder speed data are recorded the same as prior to replacement.

\*After this operation is performed, the encoder will operate normally for four days maximum even without a battery.

## 12. TROUBLESHOOTING GUIDE

### 12.1 AC SERVOMOTOR

**WARNING**

Remedies in   should be practiced  
after turning off the power

Table 12 1 Troubleshooting Guide for AC Servomotor

Trouble	Cause	What to do
Motor does not start	Loose connection	Tighten connection
	Wrong wiring	Correct
	Overload	Reduce load or use a larger motor
Unstable operation	Wrong wiring	Inspect and correct wiring across motor terminals U, V, and W, and PG
Motor overheats	Excessive ambient temperature	Reduce below 40 °C
	Motor dirty	Clean motor surface
	Overload	Reduce load or use a larger motor
Unusual noise	Motor loosely mounted	Tighten foundation bolts
	Motor misaligned	Realign
	Coupling out of balance	Balance coupling
	Noisy bearing	Check alignment, loading of bearing, lubrication and contact Yaskawa representative
	Vibration of driven machine	Contact the machine manufacturer

## 12.2 Servopack

### 12.2.1 LED Indication (7-segment) for Troubleshooting

Table 12.2 LED Indication for Troubleshooting

LED	Detection	Lighting Condition	Probable Cause	Corrective Action
1.	Over-current	Goes on when power is supplied to the control circuit	• Defective control circuit board (1 PWB)	• Replace the Servopack
		Goes on when power is supplied to the main circuit and servo power is turned on • MCCB does not trip	• Defective current feedback circuit • Defective main circuit transistor module	• Replace the Servopack
		Goes on when power is supplied to the main circuit and servo power is turned on • MCCB trips	• Defective motor grounding • Defective main circuit transistor module	• Replace the motor • Replace the Servopack
		Goes on when power is supplied to the main circuit	• Defective main circuit transistor module	• Replace the Servopack
		Goes on when the motor starts or slows down	• Incomplete (1 PWB) VR8 adjustment	• Replace the Servopack
2.	Circuit protector tripped	Goes on when power is supplied to the control circuit	• Defective control circuit board (1 PWB) (MCCB is ON status)	• Replace the Servopack
		Goes on when power is supplied to the main circuit	• Defective main circuit thyristor-diode module	• Replace the Servopack
			• MCCB trips	• Replace the Servopack
3.	Regenerative trouble	Goes on when power is supplied to the control circuit	• Defective control circuit board (1 PWB)	• Replace the Servopack
		Goes on approximately 0.5 to 1 second after power is supplied to the main circuit	• Defective regenerative transistor	• Replace the Servopack
			• Regenerative resistor disconnection	• Check and replace the regenerative resistor (Replace the Servopack)
4.	Over-voltage	Goes on when the motor starts or slows down	• Load inertia $J_L$ ( $GD^2$ ) too large	• Check the inertia of the machine with the value converted to the motor shaft
			• Defective regenerative circuit	• Replace the Servopack
5.	Over-speed	When the reference is input, the motor runs fast and 5. goes on	• Motor connection error • Absolute encoder connection error	• Correct the motor connection • Check and correct pulses in phases A and B with 2CN
			• The reference input voltage too large	• Decrease the reference input voltage
6.	Voltage drop	Goes on when power is supplied to the main circuit	• Defective main circuit thyristor-diode module	• Replace the Servopack
7.	Overload	Goes on when power is supplied to the control circuit	• Defective control circuit board (1 PWB)	• Replace the Servopack
		Goes on during operation • When power to the control circuit is turned off and then turned on again, the operation starts	• Operation with 105% to 130% or more of the rated load	• Check and correct the load (may be overload)
		Goes on during operation • When power to the control circuit is turned off and then turned on again, 7. or 8. goes on again When reset later, the operation starts	• Fan has stopped	• Check the fan (SR20, 30, 40, 60)
• Temperature around the Servopack exceeds 55°C	• Decrease the temperature below 55°C (The heat sink may be overheated)			
8.	Heat sink overheat	The motor rotates, but the torque is unavailable. When power to the control circuit is turned off and then turned on again, the operation starts, but the torque is still unavailable	• Motor circuit error connection, such as U→V, V→W, W→U or single-phase connection	• Correct the connection

## 12 2.1 LED Indication (7-segment) for Troubleshooting (Cont'd)

Table 12 2 LED Indication for Troubleshooting (Cont'd)

LED	Detection	Lighting Condition	Probable Cause	Corrective Action
<b>b.</b>	A/D error	Goes on when power is supplied to the control circuit	• Defective control circuit board (1PWB)	• Replace the Servopack
<b>c.</b>	CPU error	Goes on during operation	• Faulty internal elements • Defective internal elements	• Resume after reset operation • Replace the Servopack
<b>F.</b>	Open phase	Goes on when power is supplied to the control circuit	• Defective control circuit board (1 PWB)	• Replace the Servopack
		Goes on when power is supplied to the main circuit	• Poor connection to 3-phase power supply	• Check and correct the connection
<b>C.</b>	Overrun prevention	Goes on when power is supplied to the control circuit	• Defective control circuit board (1 PWB)	• Replace the Servopack
		The motor starts momentarily, then <b>C</b> goes on	• Motor connection error • Absolute encoder connection error	• Correct the motor connection • Check and correct pulses in phases A and B with 2CN
<b>D.</b>	Absolute control error*	Goes on when power is supplied to the control circuit	• Defective control circuit board (1PWB)	• Replace the Servopack
		Goes on approximately 1 second after SEN signal is input	• Faulty absolute encoder • Faulty internal elements • Faulty absolute encoder • Battery not yet connected • Absolute encoder connection error • Defective absolute encoder	• Drop the SEN signal, and then input the SEN signal again • Reattempt the setup of absolute encoder • Correct the absolute encoder connection • Replace the motor
<b>B.</b>	Positioning error	Goes on when power is supplied to the control circuit	• Defective control circuit board (1PWB)	• Replace the Servopack
		Goes on frequently during operation	• Defective encoder connection error • Faulty internal PG pulse counter	• Check and correct pulses in phases A, B and C with 2CN • Drop the SEN signal, and then input the SEN signal again • Consider countermeasure for possible noise interference

\* Alarm of absolute control error is reset by dropping SEN signal (Reset button need not be depressed)

## 12 2 2 Examples of Troubleshooting for Defective Wiring or Parts

Table 12 3 Example of Troubleshooting for Defective Wiring or Parts

Trouble	Check Items	What to do
MCCB trips immediately after Power On and Servo On	• Main circuit wiring (such as the ground of motor)	• Correct the wiring
The reference is input, but the motor does not run	• Voltage across <b>R</b> , <b>S</b> , and <b>T</b> • LED <b>P</b> and <b>MP</b> on	• Check the AC power supply circuit
	• Trouble LED off	• If LEDs are on, check the cause
	• Speed reference voltage • LED <b>IN</b> on • P-CON, N-OT, P-ON, S-ON signals	• Adjust the speed setting potentiometer (supplied by the user)

## 12 2 3 Examples of Troubleshooting for Incomplete Adjustment

Table 12 4 Examples of Troubleshooting for Incomplete Adjustment

Trouble	Cause	What to do
Motor rotates even if the speed reference voltage is 0 V	Incomplete ZERO potentiometer adjustment	Adjust VR3 <b>ZERO</b> correctly
Motor vibrates or vibration frequency is too high, approx 200 to 300 Hz (When vibration frequency equals commercial frequency)	Speed loop gain too high <ul style="list-style-type: none"> <li>• Excessively long lead of <i>Servopack</i> input circuit</li> <li>• Noise interference due to bundling of signal line and power line</li> </ul>	Turn VR6 <b>LOOP</b> CCW to decrease the speed loop gain <ul style="list-style-type: none"> <li>• Decrease length of lead</li> <li>• Separate input circuit line from power line or connect input circuit to low impedance less than several 100 ohms</li> </ul>
Motor speed overshoot is too large at starting or stopping	<ul style="list-style-type: none"> <li>• Speed loop gain too high</li> </ul>	<ul style="list-style-type: none"> <li>• Turn <b>LOOP</b> CCW to decrease the speed loop gain</li> </ul>

VS-800 SERIES

# AC Servo Drives

WITH ABSOLUTE ENCODER M, F, S, D SERIES FOR SPEED CONTROL



*A Better Tomorrow for Industry through Automation*

## **YASKAWA Electric Mfg. Co., Ltd.**

**TOKYO OFFICE** Ohtemachi Bldg, 1-6-1 Ohtemachi, Chiyoda-ku, Tokyo, 100 Japan  
Phone (03) 284-9111, -9145 Telex YASKAWA J33530 Fax (03) 284-9034

**SEOUL OFFICE** Seoul Center Bldg, 91-1, So Kong-Dong, Chung-Ku, Seoul Korea  
Phone (02) 776-7844 Fax (02) 753-2639

**SINGAPORE OFFICE** CPF Bldg, 79 Robinson Road No 24-03, Singapore 0106  
Phone 2217530 Telex (87) 24890 YASKAWA RS Fax (65) 224-5854

**TAIPEI OFFICE** Union Commercial Bldg, 137, Nanking East Road, Sec 2, Taipei, Taiwan  
Phone (02) 507-7065, -7732 Fax (02) 506-3837

### **YASKAWA ELECTRIC AMERICA, INC. SUBSIDIARY**

**Chicago Office (Head Office)** 3160 MacArthur Blvd, Northbrook, Illinois 60062-1917, U S A  
Phone (708) 291-2340, 291-2348 Telex (230) 270197 YSKW YSNC NBRK Fax (708) 498-2430, 480-9731

**Los Angeles Office** 7341 Lincoln Way, Garden Grove California 92641, U S A  
Phone (714) 894-5911 Telex (230) 678396 YASKAWAUS TSTN Fax (714) 894-3258

**New Jersey Office** 30 Two Bridges Road, Fairfield, New Jersey 07006, U S A  
Phone (201) 575-5940 Fax (201) 575-5947

**YASKAWA ELECTRIC EUROPE GmbH SUBSIDIARY**  
Niederhöchstädter Straße 71-73, 6242 Kronberg-Oberhöchstädt, West Germany  
Phone (06173) 640071, 640072, 640073 Telex 415660 YASE D Fax (06173) 68421

**YASKAWA ELETRICO DO BRASIL COMERCIO LTDA SUBSIDIARY**  
Av Brng Faria Lima, 1664-cj 721/724, Pinheiros, São Paulo-SP, Brasil CEP-01452  
Phone (011) 813-3933, 813-3694 Telex (011) 82869 YSKW BR Fax (011) 815-8795

*Due to ongoing product modification/improvement, data subject to change without notice.*