

---

ArtCAM Pro 8.0

# Reference Manual

By Delcam plc

ArtCAM PRO



THE QUEEN'S AWARDS  
FOR ENTERPRISE  
2003

Issue: 8.003 Released: 20/07/05

## **Disclaimer**

Delcam plc has no control over the use made of the software described in this manual and cannot accept responsibility for any loss or damage howsoever caused as a result of using the software. Users are advised that all the results from the software should be checked by a competent person, in accordance with good quality control procedures.















Information contained in this manual is subject to change without notice and does not represent a commitment by Delcam plc. The software described in this manual is furnished under licence agreement and may be used or copied in accordance with the terms of such licence. No part of this manual may be reproduced or transmitted in any form or by any means, electronic or mechanical, including photocopying and recording, for any purpose without the express permission of Delcam plc.



















Copyright © 2005 Delcam plc. All rights reserved.

Delcam plc  
Talbot Way  
Small Heath Business Park  
Birmingham B10 0HJ  
England

Tel: (UK) 0121-766-5544  
(Int) +44 (0) 121-766-5544

# Contents

<b>Overview</b>	<b>1</b>
ArtCAM Pro Overview .....	1
Information about ArtCAM Pro.....	1
Comparing Bitmaps, Vectors and Reliefs.....	3
What is a Vector?.....	3
What is a Bitmap?.....	4
What is a Relief?.....	5
<b>ArtCAM Pro Layout</b>	<b>7</b>
ArtCAM Pro Layout .....	7
Using the Design Windows .....	11
Adjusting the Window View .....	11
Opening a New 2D View Window.....	12
Labelling a 2D View Window .....	13
Deleting a 2D View Window .....	13
2D View Manipulation .....	15
 3D View .....	15
 Zoom In Tool.....	15
 Zoom Out Tool .....	15
 Zoom Previous.....	16
 Window Fit .....	16
 Zoom Object(s).....	16
 Zoom 1:1 .....	16
 Vectors On/Off .....	16
 Bitmap On/Off.....	16
 Greyscale View.....	17
 Undo.....	17
 Redo .....	17
 Link All Colours .....	17
 Unlink All Colours .....	17
 Link/Unlink Colours.....	17

	Merge Colours .....	18
	2D Bitmap Contrast Tool .....	18
	Scrolling the 2D View .....	19
	2D View Options.....	19
	Using Rulers .....	20
	Using the Snap Grid.....	20
	Using Guidelines.....	22
	Snapping to Objects .....	25
	3D View Manipulation.....	26
	2D View .....	26
	Twiddle Tool.....	26
	Pan View .....	27
	Zoom .....	27
	Zoom Out .....	28
	Previous View .....	28
	Scale To Fit .....	28
	Isometric View .....	28
	View Along X .....	28
	View Along Y .....	28
	View Along Z .....	29
	Select Relief Detail.....	29
	Draw Zero Plane .....	29
	Draw X Y .....	29
	Origin .....	30
	Objects To Draw.....	30
	Colour Shade.....	31
	3D View Options.....	31
	Using the Top Toolbar .....	33
	Updating ArtCAM Pro .....	33
	Installing Your ArtCAM Licence .....	37
	Managing ArtCAM Pro's Preferences .....	37

## **Working with Models 45**

	Getting Started .....	45
	Creating a Model .....	45
	Creating a Model from an Image.....	47
	Opening an Existing Model .....	48
	Viewing Model Information .....	50
	Closing a Model.....	50

Shutting Down ArtCAM Pro .....	51
Managing a Model .....	52
Creating a New Model.....	53
Creating a New Model Using Pixels .....	54
Opening a Model .....	54
Saving a Model.....	55
Saving the 3D View as an Image.....	56
Printing a Model .....	57
Importing Images.....	61
Editing the Model Dimensions .....	62
Editing Asymmetrical Dimensions in a Model .....	63
Setting the Position of a Model .....	65
Clearing a Model .....	67
Deskewing a Model .....	67
Creating a Greyscale Image from a Relief .....	67
Adding a Border to a Model .....	69
Using a Spot Filter on a Bitmap Image .....	70
Adjusting Light and Material Settings .....	71
Using the Selection Rectangle .....	78
Cropping a Model .....	79
Using the ArtCAM Pro Notepad .....	80
Importing Vector Artwork.....	81
Exporting Vector Artwork.....	87
Importing a 3D Model File.....	87
Importing a 3D Model File for Unwrapping .....	92
Importing CopyCAD Relief Data.....	95
Multiplate Engraving Tool .....	96
Correcting an Action .....	104
Mirroring a Model .....	105
Rotating a Model .....	105
Printing a Model .....	106
Working with Layers .....	110
Creating a New Layer.....	110
Naming a Layer .....	111
Assigning a Colour to a Layer .....	111
Manipulating Layers.....	112
Using the Font Editor.....	116
Using the Face Wizard.....	122

## **Working with Bitmaps** **129**

Drawing using Bitmaps.....	129
Bitmap Drawing Tools .....	129

Creating a Model from a Bitmap .....	130
Importing a Bitmap into a Model.....	130
Setting a Bitmap's Size and Origin .....	130
Working with Colours.....	130
Selecting the Primary and Secondary Colours .....	131
Reducing Colours .....	132
Colour Merging.....	133
Colour Linking.....	134
Edge Marking .....	135
Colour Thinning.....	135
Colour Thickening .....	136
Adding Colours.....	137
Saving a Custom Colour Palette .....	139
Loading a Custom Colour Palette.....	139
Editing a Bitmap Image .....	140
Using the Paint Brush .....	140
Using the Draw Tool.....	143
Using the Bitmap Line Tool .....	144
Using the Erase Tool.....	144
Flood Filling .....	145
Copying and Pasting Bitmap Areas .....	146
Converting a Bitmap into Vectors .....	147
Creating a Shape from a Bitmap .....	149

## **Working with Vectors 151**

Overview .....	151
Drawing with Polylines.....	152
Creating a Polyline.....	152
Completing Polyline Creation .....	154
Closing a Polyline to Create a Polygon .....	155
Amending a Polyline .....	155
Creating Simple Shapes .....	156
Creating a Rectangle.....	156
Creating a Circle .....	159
Creating an Ellipse.....	161
Creating a Polygon.....	164
Creating a Star .....	166
Creating an Arc .....	169
Editing Vector Objects.....	171
Selecting Vectors .....	172
Moving Vectors .....	174
Editing Vector Spans .....	175

Editing Vector Nodes .....	182
Deleting Vector Objects .....	191
Copying and Pasting Vector Objects.....	192
Offsetting Vector Objects .....	197
Splining Vector Objects.....	199
Filleting Vector Objects.....	203
Trimming Vector Objects .....	207
Wrapping Vectors to a Relief.....	209
Locking and Unlocking Vector Objects .....	211
Fitting Arcs to Vector Objects.....	211
Nesting Vector Objects.....	212
Distorting Vector Objects .....	218
Pasting Vectors Along a Curve .....	223
Converting Vector Objects .....	224
Creating a Vector Border.....	225
Using the Vector Doctor.....	226
Working with Vector Text .....	229
Creating Vector Text .....	230
Selecting Vector Text .....	231
Editing Vector Text .....	231
Formatting Vector Text .....	233
Wrapping Text Round a Curve.....	238
Measuring Vector Objects .....	243
Transforming Vector Objects .....	244
Using Transform Vectors Mode.....	244
Using the Transform Vector(s) Page.....	246
Manipulating Vector Objects.....	254
Mirroring Vectors .....	254
Aligning Vectors.....	257
Centring Vectors.....	258
Merging Vectors .....	259
Joining Vectors .....	262
Closing Vectors .....	265
Clipping Vectors.....	266
Slicing Vectors.....	268
Grouping Vector Objects .....	270
Viewing the Properties of a Vector Object.....	272
Reversing a Vector Object's Direction.....	274
Ungrouped Vectors.....	274
Grouped Vectors.....	275
Creating Bitmaps from Vectors .....	275
Flood Filling Vector Objects .....	276
Importing Vector Artwork .....	276

Exporting Vector Artwork .....	276
Creating a Shape from a Vector .....	277
Creating a Feature from a Vector .....	277
Creating a Raised Feature .....	277
Creating a Recessed Feature .....	280
Creating a Centreline Engraved Feature .....	281
Returning a Feature to a Vector .....	282

## **Working with Reliefs 285**

Overview .....	285
Using the Shape Editor .....	286
Creating a Shape from a Bitmap .....	286
Creating a Shape from a Closed Vector .....	290
Creating a Shape Using Vectors .....	294
Creating a Swept Profile Shape .....	295
Creating a Two Rail Sweep .....	310
Creating a Weave Shape .....	316
Creating ISO-FORM Letters .....	320
Creating a Dome .....	323
Creating a Feature .....	324
Calculating a Relief .....	325
Replacing the Relief .....	326
Adding to the Relief .....	326
Subtracting from the Relief .....	328
Merging with the Relief .....	330
Transforming and Manipulating Reliefs .....	333
Using 3D Clipart .....	333
Copying and Pasting a Relief .....	344
Pasting a Relief along a Vector .....	349
Inverting a Relief .....	351
Smoothing a Relief .....	352
Scaling the Relief Height .....	354
Scaling to Volume .....	356
Mirroring a Relief .....	357
Mirror Merging a Relief .....	358
Offsetting a Relief .....	359
Resetting a Relief .....	360
Resetting the Relief Height .....	360
Managing and Editing Reliefs .....	361
Saving a Relief .....	362
Loading a Relief .....	363
Calculating the Surface Area .....	366



Displaying the Calculation Time .....	367
Adding a Draft Angle .....	368
Creating a Triangle Mesh .....	368
Creating a Cross-Section .....	370
Creating an Angled Plane .....	371
Blending 3D Shapes .....	374
Relief Envelope Distortion .....	378
Fading a Relief.....	386
Creating a Ring.....	390
Adding Texture to a Relief.....	390
Sculpting a Relief .....	397
Removing Holes in the Relief Surface .....	402
Creating a Greyscale Image from a Relief .....	402
Rotating a Relief or Triangle Mesh .....	402

## **Machining Models 403**

Overview .....	403
Using Toolpaths.....	405
2D Toolpaths.....	405
2D Profiling .....	407
2D Area Clearance.....	417
V-Bit Carving .....	423
Bevel Carving .....	428
Smart Engraving .....	434
Machine Vectors.....	441
Inlay Wizard .....	447
Drill Holes .....	476
3D Toolpaths.....	481
Machine Relief.....	481
Feature Machining.....	486
Z Level Roughing.....	490
Laser Machining .....	495
3D Cut Out.....	498
3D Rest Machining.....	505
Managing and Modifying Toolpaths .....	508
Selecting Toolpaths .....	509
Transforming Toolpaths .....	510
Copying Toolpaths .....	512
Merging Toolpaths .....	521
Creating Toolpath Panels.....	523
Editing a Profile Pass.....	527
Setting the Machining Order .....	537

Adjusting the Machining Parameters of a Tool.....	540
Saving a Toolpath .....	543
Editing a Toolpath .....	545
Deleting Toolpaths.....	546
Calculating a Single Toolpath .....	548
Calculating a Batch of Toolpaths .....	549
Using a Toolpath Summary .....	550
Using the Tool Groups Database.....	554
Adjusting the Material Setup .....	562
Deleting the Material .....	564
Creating a Toolpath Template .....	564
Loading a Toolpath Template.....	565
Loading Toolpath Data .....	566
Setting the Toolpath Order .....	567
Simulating Toolpaths .....	567
Viewing a Toolpath .....	573
Hiding a Toolpath .....	575
Resetting a Simulation.....	576
Deleting a Simulation .....	577
Saving a Simulation as a Relief.....	577
Loading a Simulation from a Relief .....	578

## Index

**579**

# Overview

---

## ArtCAM Pro Overview

ArtCAM Pro is a unique software program which allows users to easily create impressive, high quality 3D products starting from 2D bitmap or vector based artwork. ArtCAM Pro transforms ideas into finished products far more quickly than is possible using conventional methods. Even in cases where a hand-finished look is desired, ArtCAM Pro accelerates production. Using ArtCAM Pro and a machine tool or router to machine most of the job, leaves the artisan more time to concentrate on the original design and the fine details, which together help to differentiate products in today's competitive markets.

---

## Information about ArtCAM Pro

You can find information about the features in ArtCAM Pro from the following sources:

1. The ArtCAM Pro **Assistant** (In-line Help). Click on the **Show Help** on each page displayed in the **Assistant** window to view its In-Line Help. For further details, see "ArtCAM Pro Layout" in the ArtCAM Pro Layout chapter.
2. The ArtCAM Pro On-Line Help pages. From the Main menu bar, click on the **Help** menu, followed by the **Index** option. You can find a list of shortcuts that can be used in ArtCAM Pro here.
3. The **Assistant's Getting Started** page. Click on the  icon in the **Other Features** area to display details of the latest features in ArtCAM Pro.

4. The ArtCAM Pro Reference Manual (this manual).
5. The ArtCAM Pro Website. From the Main menu bar, click on the **Help** menu, followed by the **ArtCAM Pro On The Web > ArtCAM Pro Home Page** option.
6. The ArtCAM User Forum. From the Main menu bar, click on the **Help** menu, followed by the **ArtCAM Pro On The Web > ArtCAM Pro Forum** option. You can also access the forum at <http://forum.artcam.com>.

If you have not already registered as a forum member, click on the **Join** option on the forum's Home Page to do so. Registered users are able to download images, example ArtCAM models and relief files attached to posts.

7. Subscribe to the ArtCAM Pro Newsletter. From the Main menu bar, click on the **Help** menu, followed by the **Subscribe to the ArtCAM Pro Newsletter** option to send an e-mail requesting subscription to the quarterly newsletter.
8. The Frequently Asked Questions page. From the Main menu bar, click on the **Help** menu, followed by the **ArtCAM Pro On The Web > Frequently Asked Questions** option.

## ***ArtCAM Pro Reference Manual***

This manual provides you with instructions on how to create and manipulate both 2D and 3D models, and then machine them.

This Reference Manual is divided into the following sections:

- **Overview.** This section provides an overview of what ArtCAM Pro can be used for.
- **ArtCAM Pro Layout.** This section explains the layout of ArtCAM Pro, how to use its design windows and manage its preferences.
- **Working with Models.** This section explains how to create and manage an ArtCAM model, as well as create and edit fonts for use within ArtCAM Pro.
- **Working with Bitmaps.** This section explains how to create and manipulate bitmap images in a model. These can then be used to create vector objects or 3D shapes as all or part of a relief in a model.

- **Working with Vectors.** This section explains how to create and manipulate vector artwork in a model. This can then be used to create a three-dimensional shape as all or part of a relief, or to machine a 2D model.
- **Working with Reliefs.** This section explains how to create different types of shapes and combine them with any existing relief, how to transform, manipulate, edit and manage the relief. The relief can then be used to machine a 3D model.
- **Machining Models.** This section explains how to machine a model from the vector artwork or three-dimensional relief that you have created.

---

## Comparing Bitmaps, Vectors and Reliefs

Vectors and bitmaps are two different methods of reproducing particular types of images. ArtCAM Pro uses both bitmap images and vector objects to create three-dimensional shapes. In ArtCAM Pro, a vector object can be created from a bitmap image, and vice versa. For more details, see the Working with Bitmaps and Working with Vectors chapters.

*Vector Data*

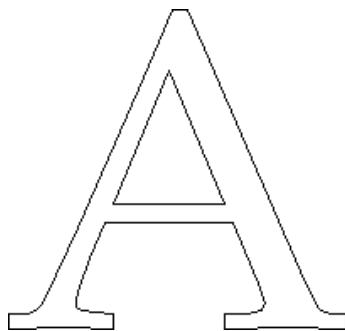

*Bitmap Data*

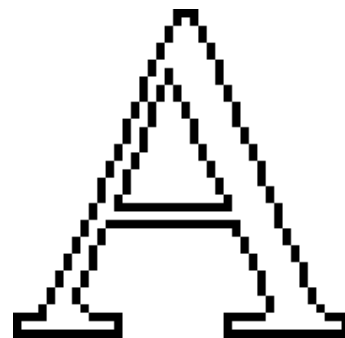

The three-dimensional shapes created from the bitmap images and vector objects in ArtCAM Pro make up a relief. This relief is used to machine a 3D model.

### What is a Vector?

Vector data is defined mathematically. Objects are geometrical, being made up of a number of points connected by lines or curves. Vectors

are extremely flexible and can be manipulated with both ease and accuracy.

The amount of data required to display all of the attributes of a vector object is very small, so graphics made up of vector objects can have very small file sizes. As the objects become more complex, the sizes increase.

Vector data is ideal for producing smooth features. A vector object not only has greater definition than the bitmap, the geometry of the vector object can also be used to drive an assigned machining tool directly, which, in turn, can produce a better finish.

ArtCAM Pro can read files containing vector data saved in the following formats:

- Drawing Interchange files, including PowerSHAPE and AutoCAD (**.dxf**)
- Encapsulated PostScript format (**.eps**)
- AutoCAD 2D Drawing files (**.dwg**)
- Adobe Illustrator image (**.ai**)
- Windows Metafile (**.wmf**)
- Lotus, PC Paint or DUCT picture (**.pic**)

## What is a Bitmap?

Bitmap data is made up of a set of values specifying the colour of individual pixels (picture elements) that make up an image. Bitmap data is characterised by resolution and bit depth.

Resolution relates to the detail in an image and is expressed in dots per inch (**.dpi**) or pixels per inch (**.ppi**). The higher the resolution (i.e. the more dots used to describe the image), the more detail possible.

Bit depth has to do with the number of colours the image can display. Bits are the building blocks of binary data. A black and white image is 1 bit, meaning it can be off or on, black or white. As bit depth increases, more colours are available.

Unlike vector data, bitmap data is large. For example, a simple object like the letter in the previous image is 32,838 bytes as vector data in ArtCAM Pro. When rasterized (changed to a bitmap), the file size changes to 40,078 bytes in ArtCAM Pro. For small compositions the increase in file size may not matter greatly, but for larger compositions the difference in file size seriously impacts machining times.

ArtCAM Pro allows three-dimensional shapes to be created from areas of bitmap colour. It can also read bitmap files generated by other drawing and desktop publishing packages or those scanned from paper based artwork saved in any of the following formats:

- Windows Bitmap (**.bmp**)
- TIFF image (**.tif**)
- PCX image (**.pcx**)
- CompuServe image (**.gif**)
- JPEG image (**.jpg or .jpeg**)

## What is a Relief?

A relief is made up of one or more three-dimensional shapes created in ArtCAM Pro. A three-dimensional shape becomes all or part of a relief when the relief combination method selected for the shape has been calculated.

Ultimately, a relief is made up of a grid of points in a similar way to a bitmap image. However, instead of colour, each point is assigned a specific height.

When a new model is created in ArtCAM Pro, you are required to set its size in millimetres or inches. The model's resolution is also specified here. The number of points in the model determines the resolution of the relief and any associated bitmap image. For further information, see "Creating a Model" in the Working with Models chapter.

A compromise must be made between the quality of a model, including any relief within it, and the speed of the processor in your computer. For most jobs, a model of 1,000,000 points is a reasonable value. Since a relief is made up of a number of points, even the quality and smoothness of the three-dimensional shapes created from vector objects depends on the resolution of the model, although this is to a lesser extent than with those shapes created from bitmap images.

A relief can be saved or loaded in the **.rlf** format. If there is no bitmap image of the same resolution as the relief, ArtCAM Pro creates a greyscale bitmap representation of the 3D model when it is loaded.





# ArtCAM Pro Layout

---

## ArtCAM Pro Layout

The ArtCAM Pro screen layout has been designed to let you work effectively and efficiently.

The hub of ArtCAM Pro is the innovative **Assistant** window. When you have an open model, the **Assistant's** Home page displays a collection of tools to help you create, edit and machine a model. These tools appear in the form of buttons.

Grouped in a logical arrangement, you can navigate to the button that you require quickly. To find out more about most of the buttons in ArtCAM Pro, click on it to display a page in the **Assistant** window showing In-line Help. The In-line Help informs you of exactly where, when and how to use the button, thus reducing the learning curve.

The screen layout is divided into eight regions:

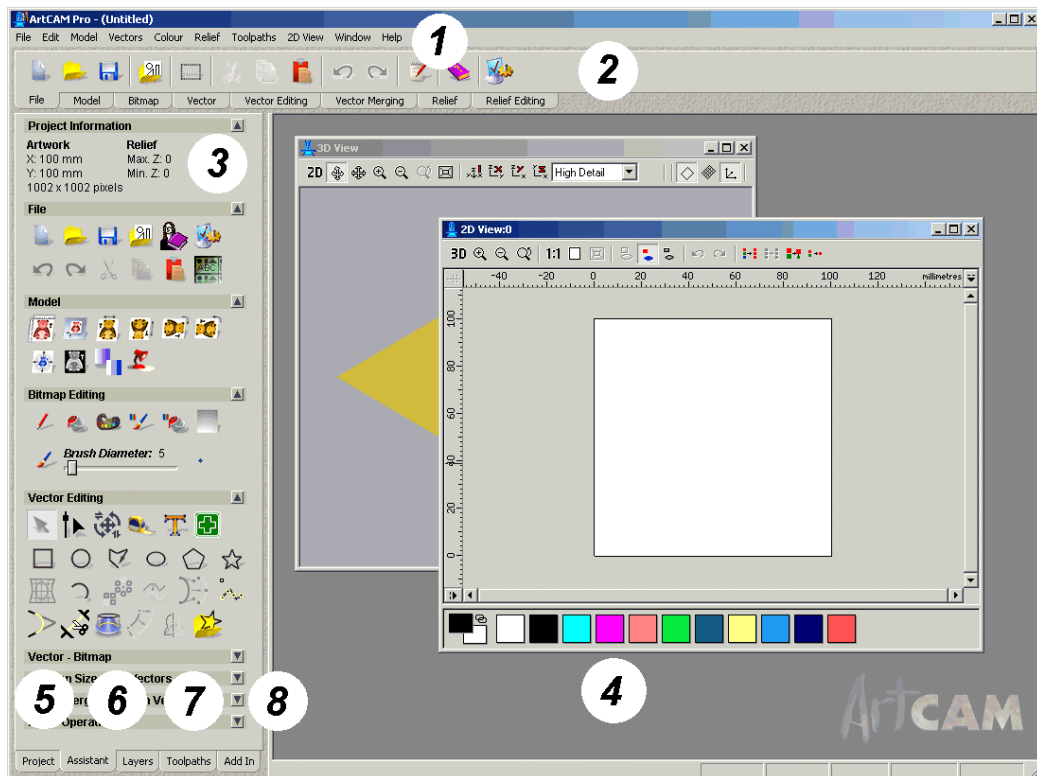



1. **Main menu bar** - Click on a menu item to display a drop-down menu that contains a range of sub-menus and commands relating to the features in ArtCAM Pro. If an item in a menu is greyed-out, then it does not apply to the currently active **2D View** window.
2. **Top toolbar** - Click on one of the eight available tabs to display a toolbar that contains a range of buttons relating to the features in ArtCAM Pro.
3. **Assistant Window** - On starting ArtCAM Pro, the **Assistant's Getting Started** page is displayed. This page is divided into three areas. The **Create Model** area allows you to create a new ArtCAM model of a specific size, or from an imported image file. The **Open Model** area allows you to open existing ArtCAM model files, listing the last four models on which you have been working. The **Other Features** area allows you to create new or modify existing fonts, create a face relief from a photographic image and find out about the latest features in ArtCAM Pro.

When a model has been created or opened, the **Assistant's Home** page is displayed. The **Assistant's Home** page contains buttons for almost all of the features in ArtCAM Pro, as well as a summary of your model and relief dimensions. For almost every button you click on, a



corresponding interactive In-line Help page is displayed in its place. These buttons are divided into ten areas:

- **File** - You can use these buttons to manage your model files, as well as the image, vector and triangle model files that you want to use.
- **Model** - You can use these buttons to manage the appearance of your model, as well as adjust how a model appears in the **3D View** window.
- **Bitmap Editing** - You can use these buttons to draw and paint bitmap shapes, as well as manage the content of the Colour Palette and the size and shape of the brush you use.
- **Vector Editing** - You can use these buttons to create vector objects in the form of shapes or text, as well as measure and manipulate the vector objects that make up the artwork in your model.
- **Vector - Bitmap** - You can use these buttons to convert a vector object in your model to a bitmap, or vice versa.
- **Position Size Align Vectors** - You can use these buttons to transform, mirror, align and centre vector objects, as well as wrap them around a curve or nest them within a defined area.
- **Group Merge Join Trim Vectors** - You can use these buttons to group, merge, join, trim, clip and slice the vector objects you create as part of your model.
- **Relief Operations** - You can use these buttons to load, save and calculate reliefs, create a triangle mesh or cross-section.
- **Vector Based Relief Creation** - You can use these buttons to create three-dimensional shapes from the vector artwork in your model, and paste an imported relief along a vector object.
- **Relief Editing** - You can use these buttons to scale, smooth, invert, offset, sculpt, reset or add texture to a relief. You can also create an angled plane or a blended shape, distort a relief or copy and paste a relief.

You can change the appearance of the **Assistant's** Home page in the following way:

- Click on the arrow displayed in each of the ten areas of the **Assistant's** Home page to either hide  or display  the buttons within that particular area.

You can also change the appearance of each page displayed in the **Assistant** window when you click on any of the buttons on the **Assistant's** Home page:

- Click on **Hide Help** to hide all In-line Help shown on the page. You can also click on the  icon in the top-right corner of the page to hide In-line Help shown.
- Click on **Show Help** to display In-line Help on the page. You can also click on the  icon in the top-right corner of the page to display the In-line Help.
- Click on the  icon in the top-right corner of the page to return to the **Assistant's** Home page.

You can play a video tutorial on how you can use the page that is currently displayed in the **Assistant** window if you:

- Click on the video icon  when the In-line Help is shown.

4. **Design Windows** - This is the central area of the screen. ArtCAM Pro uses two types of view. The **2D View** window displays the vector and bitmap artwork in your model and previews of any calculated 2D toolpaths, while the **3D View** window displays a three-dimensional relief and any calculated or simulated toolpaths.
5. **Project** - This tab displays the **Project** page in the **Assistant** window. You can use this page to view information about your model, to create, delete or edit the design windows and calculate reliefs. You can also edit, calculate, delete and simulate toolpaths, or create a template from them.
6. **Layers** - This tab displays the **Layers** page in the **Assistant** window. You can use this page to organise the vector artwork in your model into layers. Each layer you create can be given its own name and colour. You can also toggle the visibility, snapping and locking for the vector

artwork on each layer. You can also use this page to control which sheet of nested vectors or plates is active at any given time.

7. **Toolpaths** - This tab displays the **Toolpaths** Home page in the **Assistant** window. You can use this page to create machining toolpaths, drill holes, add bridging and lead moves, manage the machining order, produce a toolpath summary, and manage the tools database.

You can also use this page to simulate toolpaths, save toolpaths, edit toolpaths, load or save a toolpath template, and edit the machining parameters relating to a tool.

8. **Add In** - This tab displays the **Add Ins** page in the **Assistant** window. You can use this page to control 'plug-in' tools compatible with ArtCAM Pro. The root of the **Add In** tab is in the ArtCAM Pro installation folder, and 'plug-in' tools will be made available to download from the ArtCAM **Maintenance Download** page. For details, see "Updating ArtCAM Pro" on page 34.

---

## Using the Design Windows

When you create or open a model in ArtCAM Pro, a **2D View** and a **3D View** design window are displayed. You use the **2D View** window to create the vector and bitmap artwork you need to produce a three-dimensional relief in ArtCAM Pro. This relief is shown in the **3D View** window.

### Adjusting the Window View

You can adjust the appearance of the **2D View** and **3D View** windows in ArtCAM Pro:

1. From the Main menu bar, click on the **Window** menu, followed by the option for how you want the design windows to be displayed:
  - **Cascade** - Click on this option to display both the **2D View** and **3D View** windows overlapping one another.
  - **Tile** - Click on this option to display both the **2D View** and **3D View** windows beside one another.

- **2D View** - Click on this option to display the **2D View** window only.



---

**Note:** You can also display the **2D View** window by pressing the **F2** key on your keyboard when the **3D View** window is displayed.

---

- **3D View** - Click on this option to display the **3D View** window only.



---

**Note:** You can also display the **3D View** window by pressing the **F3** key on your keyboard when the **2D View** window is displayed.

---

You can also select which design window is displayed from the **Project** page:

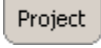
1. Click on the **Project** tab  to display the **Project** page.
2. With the **Views** element shown, click on the **2D View** or **3D View** window that you want to view.

## Opening a New 2D View Window

To open a new **2D View** window:

- From the Main menu bar, click on the **2D View** menu, and then on the **New View** option.

A **2D View** window appears named as **2D View: 1** by default. You can change the name of the new window if you want to. For details, see "Labelling a 2D View Window" on page 13.

The content within the new **2D View** window is identical to that of the previous window.

The Colour Palette beneath the new **2D View** window is the same as that which is below the previous **2D View** window, although any colour links or relief attributes used are removed.

You can also open a new **2D View** window from the **Project** page:

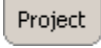
1. Click on the **Project** tab  to display the **Project** page.
2. With the **Views** element shown, right-click on the last **2D View** created to display the context menu, and then click on the **New View** option.

## Labelling a 2D View Window

The **2D View** window that automatically appears when you open or create a model is named **2D View: 0** by default. You can edit the name of any **2D View** window that is open in your current ArtCAM Pro session.

To edit the name of a **2D View** window:

1. Make sure that the **2D View** window you want to rename is active by clicking on it.
2. From the Main menu bar, click on the **2D View** menu, and then on the **Edit View Name** option. The **Edit View Name** dialog box appears:

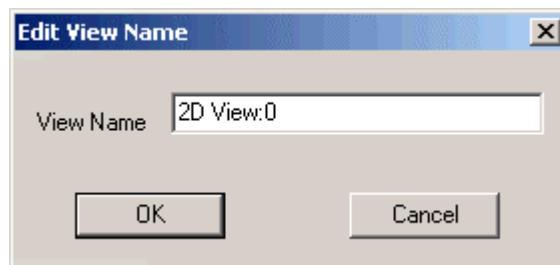

3. Click in the **View Name** box and then type the name you want for the **2D View** window in it.
4. Click on the **OK** button to close the **Edit View Name** dialog box.

You can also edit the name of any **2D View** window from the **Project** page:

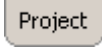
1. Click on the **Project** tab  to display the **Project** page.
2. With the **Views** element shown, right-click on the **2D View** that you want to name to display the context menu, and then click on the **Edit View Name** option.
3. Type the name you want to use for the **2D View** window, then click.

## Deleting a 2D View Window

You can delete any active **2D View** window in a model:

1. Make sure that the **2D View** window you want to delete is active by clicking on it.

2. From the Main menu bar, click on the **2D View** menu, and then on the **Delete View** option.

If you have not previously saved the current model, or any changes that you have made since it was saved last, the following message box appears:

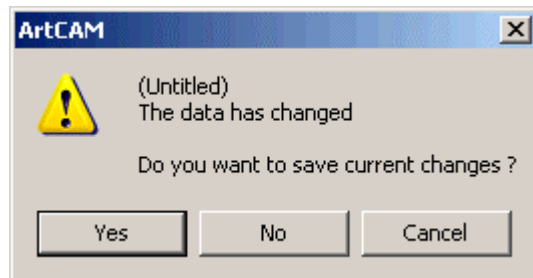

3. If you want to save the changes in the model:
  - Click on the **Yes** button to open the **Save As...** dialog box. For details on using the **Save As...** dialog box, see "Saving a Model" in the Working with Models chapter.

If you do not want to save the model you are working on:

- Click on the **No** button to close the message box and the **2D View** window. The **Getting Started** page appears in the **Assistant** window. For details, see "Getting Started" in the Working with Models chapter.

If you have decided that you do not want to delete the **2D View** window:

- Click on the **Cancel** button to close the message box.

You can also delete any **2D View** window from the **Project** page:

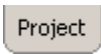
1. Click on the **Project** tab  to display the **Project** page.
2. With the **Views** element shown, right-click on the **2D View** that you want to delete to display the context menu, then click on the **Delete View** option. For further details, see "Viewing Model Information" in the Working with Models chapter.



---

# 2D View Manipulation

You can change the **2D View** of a model using the tools above the window:



## **3D View**

Click on the **3D View** button  to display the **3D View** window.





---

**Note:** You can also display the **3D View** window by pressing the **F3** key on your keyboard.



---

## **Zoom In Tool**

You can use the **Zoom In Tool** button  in two ways. You can:

- Enlarge the area directly beneath the  cursor by 50%.
- Zoom in on a defined area of the model.

To enlarge an area directly beneath the  cursor by 50%:

1. Click on the **Zoom In Tool** button , move the magnifying cursor  over the area of the model that you want to zoom in on, and then click.





---

**Note:** You can also magnify the area directly beneath the cursor by 50% if you hold down the **Ctrl** key on your keyboard and right-click.

---

To zoom in on a defined area of the model:

1. Click on the **Zoom In Tool** button , and then move the magnifying cursor  over the area of the model that you want to zoom in on.
2. Click and drag to create a bounding box around the area of the model that you are interested in.
3. Release the left mouse button to view the area defined by the bounding box you have drawn.

## **Zoom Out Tool**

Each click on the **Zoom Out Tool** button  reduces the size of the image by 50%.



---

**Note:** You can also reduce the area directly beneath the cursor by 50% if you hold down the **Shift** key on your keyboard and right-click.

---

## **Zoom Previous**

Click on the **Previous Zoom** button  to restore the previous zoom setting.

## **Window Fit**

Click on the **Window Fit** button  to automatically adjust the zooming to view the whole model.

## **Zoom Object(s)**

Click on the **Zoom Object(s)** button  to focus in on a selected vector object within the model. For details, see "Selecting Vectors" in the Working with Vectors chapter.

## **Zoom 1:1**

Click on the **Zoom 1:1** button  to return to a zoom aspect ratio of 1:1.

## **Vectors On/Off**

Click on the **Vectors On/Off** button  to hide the vector objects drawn in the model from view.

Click on the **Vectors On/Off** button  to display the vector objects drawn in the model.

## **Bitmap On/Off**

Click on the **Bitmap On/Off** button  to hide the bitmap images drawn in the model from view.

Click on the **Bitmap On/Off** button  to display the bitmap images drawn in the model.

## **Greyscale View**

Click on the **Greyscale View** button  to display a greyscale view of the existing relief.

Click on the **Greyscale View** button  to hide the greyscale view of the existing relief.



---

**Note:** You can set the default colours used in the **Greyscale View** using the **ArtCAM Options** page. For details, see "Managing ArtCAM Pro's Preferences" on page 37.

---

## **Undo**

Click on the **Undo** button  to cancel each of your consecutive editing actions, working backwards.

## **Redo**

Click on the **Redo** button  to repeat each of the editing actions you have previously cancelled in succession, working forwards.

## **Link All Colours**

Click on the **Link All Colours** button  to simultaneously link all colours in the current Colour Palette, other than the Secondary Colour, to the Primary Colour.

## **Unlink All Colours**

Click on the **Unlink All Colours** button  to unlink all colours currently linked together in the Colour Palette.

## **Link/Unlink Colours**

Click on the **Link/Unlink Colours** button  to link the Secondary Colour to the Primary Colour.

You can see that the Secondary and Primary Colours are linked when they appear in the Colour Palette as follows:



When the Secondary Colour is linked to the Primary Colour, it is displayed as the Primary Colour in the bitmap image.

Click on the **Link/Unlink Colours** button  again to unlink the Secondary Colour from the Primary Colour.



---

**Note:** You can also link or unlink the Secondary and Primary Colours if you click on the **Link/Unlink Colours** icon  in the Colour Palette or double right-click on the Secondary Colour itself.

---

## **Merge Colours**

Click on the **Merge Colours** button  to merge the current Secondary Colour with the current Primary Colour.

## **2D Bitmap Contrast Tool**

You can adjust the contrast of a bitmap image shown in the **2D View** window, making it far easier to draw vector outlines representing specific areas within the bitmap image.

The contrast command changes the amount of shading applied to a bitmap image shown in the **2D View** window. You can use it to blur the image, to make colours appear more saturated.

*2D Bitmap Contrast slider set at 100%...*

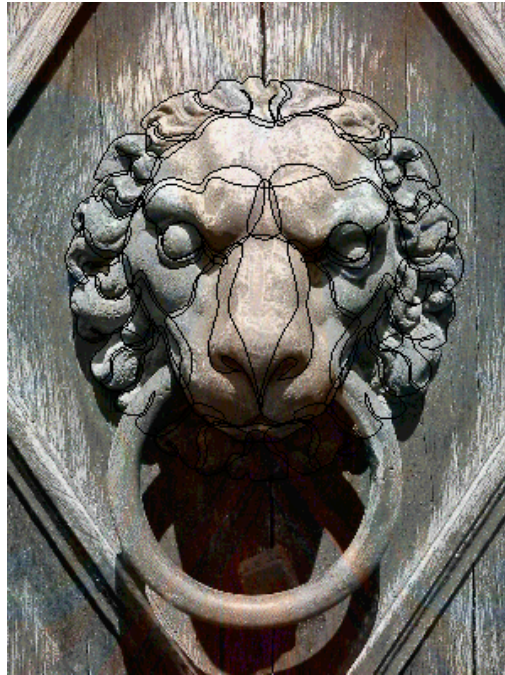

*2D Bitmap Contrast slider set at 50%...*

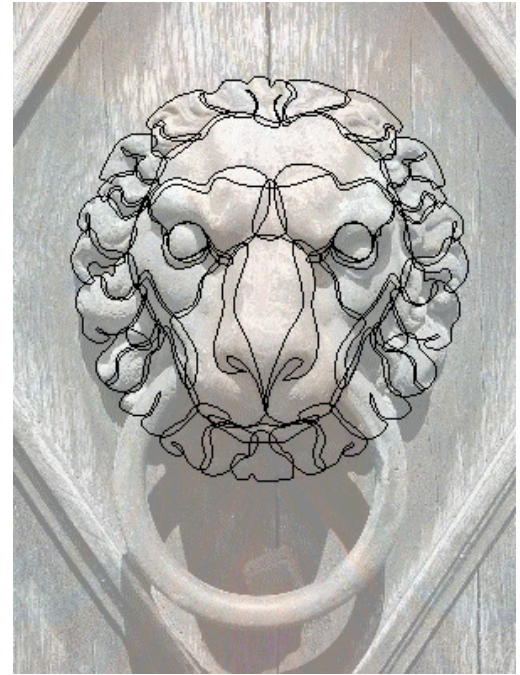

The ability to adjust the contrast of a bitmap image from within ArtCAM Pro greatly reduces the need to edit the image elsewhere before it is imported. It is a particularly useful tool when working with scanned or faxed data.

The **2D Bitmap Contrast** slider is located on the far-right side of the **2D View** toolbar, as shown below:



To set the contrast applied to the bitmap image, click and drag on the **2D Bitmap Contrast** slider. Click and drag the slider to the right to restore the image to its original sharpness, or click and drag the slider to the left to blur the image.

## Scrolling the 2D View

If you cannot see all of an open model in the **2D View** window, often as a result of zooming in, ArtCAM Pro automatically displays scrollbars along the vertical and horizontal axes:

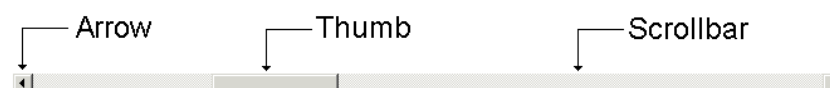

To view a different area of the open model, you can:

- Click on the arrow at either end of the scrollbar.
- Drag the thumb in the scrollbar to the appropriate position.
- Click directly in the scrollbar on either side of the thumb to page back and forth.

---

## 2D View Options

When drawing vector objects in ArtCAM Pro, there are three invaluable features available to help you create a vector object according to an exact set of measurements. These are:

- Rulers. For details, see "Using Rulers" on page 20.
- The Snap Grid. For details, see "Using the Snap Grid" on page 21.
- Horizontal and vertical guidelines. For details, see "Using Guidelines" on page 23.

These features help consistently align and size vector objects.

### Using Rulers

You can use the rulers adjacent to the X and Y-axis of the **2D View** window to make measurements.

The ruler along the X-axis also displays the units of measurement (millimetres or inches) selected for the model that is shown in the **2D View** window. For details, see "Creating a Model" in the Working with Models chapter.

To turn the rulers off:

1. From the Main menu bar, click on the **2D View** menu, followed by the **Show Rulers** option to deselect it. The rulers along the X and Y-axis of the **2D View** window are hidden.

To turn the rulers on:

1. From the Main menu bar, click on the **2D View** menu, followed by the **Show Rulers** option to select it. Rulers appear adjacent to the X and Y-axis of the **2D View** window.

## Using the Snap Grid

The snap grid is a network of fixed points that controls the placement of vector objects, making it easier to consistently size and align them.

You can use the **Snap Grid Settings** dialog box to adjust the spacing of gridlines, to activate or deactivate the grid, or to force vector objects to automatically align themselves to the snap grid.

### *Displaying the Snap Grid*

To display the snap grid in an active **2D View** window

1. From the Main menu bar, click on the **2D View** menu, followed by the **Snap Grid Settings** option. The **Snap Grid Settings** dialog box is displayed:

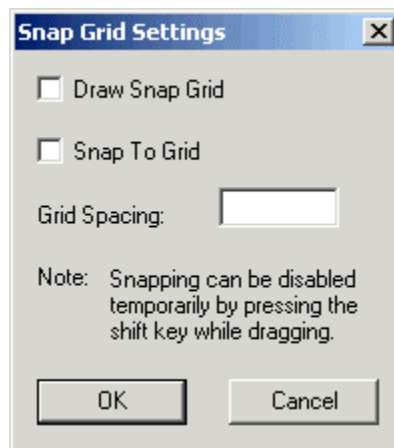

2. Click to select the **Draw Snap Grid** option .
3. Click on the **OK** button to close the **Snap Grid Settings** dialog box and draw the snap grid.

To hide the snap grid in an active **2D View** window, repeat the previous steps, clicking on the **Draw Snap Grid** option to deselect it .

### *Setting the Grid Spacing*

You can set the spacing between grid points using the model's units of measurement selected in the **Setup Job Dimensions** dialog. For details, see "Creating a Model" in the Working with Models chapter.

To set the grid spacing:

1. From the Main menu bar, click on the **2D View** menu, followed by the **Snap Grid Settings** option to display the **Snap Grid Settings** dialog box:

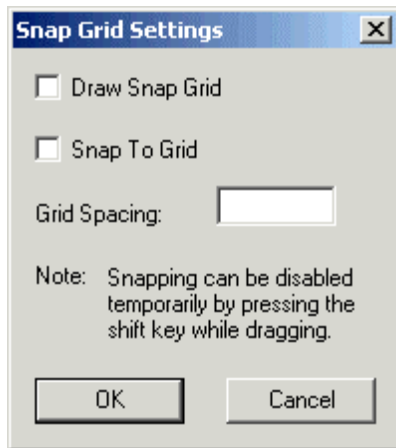

2. Define the distance between each grid point in the **Grid Spacing** box.
3. Click on the **OK** button to close the **Snap Grid Settings** dialog box and set the grid spacing.

## ***Snapping to the Grid***

To make the cursor snap to the nearest point on the grid when creating or editing a vector object:

1. From the Main menu bar, click on the **2D View** menu, followed by the **Snap Grid Settings** option to display the **Snap Grid Settings** dialog box:

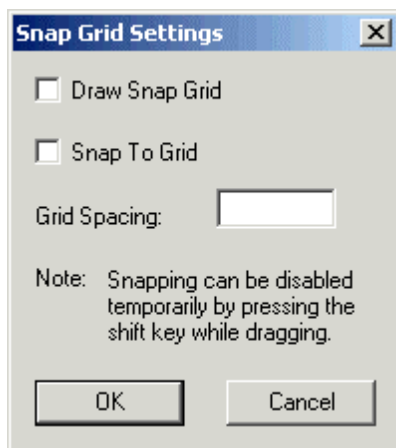

2. Click on the **Snap To Grid** option to select it .
3. Click on the **OK** button to close the **Snap Grid Settings** dialog box and activate grid snapping.



---

**Note:** To temporarily disable the snapping behaviour, press and hold down the **Shift** key on your keyboard.

---



## Using Guidelines

While a **Snap Grid** is made up of a network of fixed points, a guideline is a solid line parallel to either the horizontal (X) or vertical (Y) axis that can be moved to any position in the **2D View** window.

To create guidelines, the rulers must be checked on. For details, see "Using Rulers" on page 20.

To create a horizontal guideline:

- Click and hold down the left mouse button on the top ruler to display a guideline in the **2D View** window, and then drag it into position.

To create a vertical guideline:

- Click and hold down the left mouse button on the left-hand ruler to display a guideline in the **2D View** window, and then drag it into position.

To reposition a guideline:

- Move the cursor over the guideline you want to move. When the cursor changes to a double-headed arrow  $\leftrightarrow$ , click and drag the guideline into its new position.



---

**Warning:** You must have the both the **Show Rulers** and the **Show Guidelines** options selected in the **2D View** menu to see guidelines in the **2D View** window.

---

### *Defining a Guideline's Position*

You can define the position of a guideline using the **Position Guide** dialog box. This is a more accurate method than clicking and dragging a guideline into position.

To display the **Position Guide** dialog box, move the mouse cursor over a guideline and click the right mouse button:

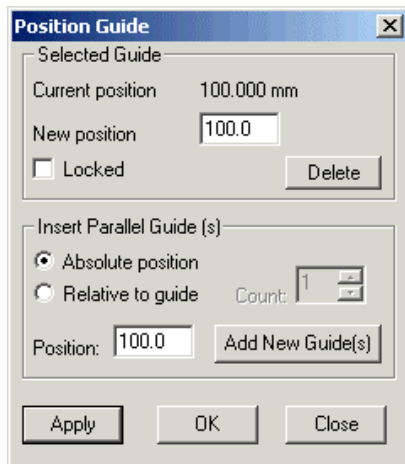

The **Selected Guide** area of the **Position Guide** dialog box allows you to:

- Reposition a guideline.
- Delete a guideline.
- Lock a guideline into position.

To reposition a guideline:

- Define the new position for the guideline in the **New Position** box, and then click on the **Apply** button.

To delete a guideline:

- Click on the **Delete** button.

To lock a guideline in its current position:

- Click to select the **Locked** option .



The **Insert Parallel Guide(s)** area of the **Position Guide** dialog box allows you to:

- Create a guideline at an absolute position.
- Create any number of guidelines at a position relative to the selected guideline.

To insert a parallel guideline at an absolute position:

1. Click to select the **Absolute position** option .
2. Define the position of the parallel guideline in the **Position** box.
3. Click on the **Add New Guide(s)** button to draw the guideline.
4. Click on the **OK** button to close the **Position Guide** dialog box.

To insert any number of parallel guidelines at a relative position:

1. Click to select the **Relative to guide** option .
2. Define the number of guidelines that you want to draw using either of the following methods:
  - Type the number of guidelines in the **Count** box.
  - Use the  and  buttons on the right of the **Count** box to set the number of guidelines.
3. Define the distance between each of these parallel guidelines in the **Position** box. You can set the relative position for the new guidelines using a positive or negative value.

For example, if you want to create a new guideline to the right of an existing vertical guideline, or above an existing horizontal guideline, you must type a positive value in the **Position** box e.g. 10.

If you want to create a new guideline to the left of an existing vertical guideline, or below an existing horizontal guideline, you must type a negative value in the **Position** box e.g. -10.
4. Click on the **Add New Guide(s)** button to draw the guidelines.



---

**Tip:** If you want to carry out more than one action in the **Position Guide** dialog box, instead of clicking on the **OK** button, click on the **Apply** button. This applies the change and keeps the dialog box open.

---

## Snapping to Objects

Using snapping, you can align a vector object relative to another vector object on any visible layer or guideline shown in the **2D View** window. For further information on guidelines, see "Using Guidelines" on page 23. For further details on layers, see "Snapping on a Layer" in the Working with Models chapter.

Snapping is enabled by default. You can enable and disable snapping as follows:

1. From the Main menu bar, click on the **2D View** menu, followed by the **Snap to Objects** option.

When enabled, the **Snap to Objects** option is selected , and vice versa.



---

**Note:** Make sure that the **Toggle Snapping** button for the layer is also enabled . For details, see "Snapping on a Layer" in the Working with Models chapter.

---





---

**Tip:** To temporarily disable snapping, press and hold down the **Shift** key on your keyboard.

---

With the **Snap to Objects** option enabled, the mouse cursor shown in the **2D View** changes when it snaps to any of the following places:





- A point (node) in another vector object. This is shown by the cursor changing to a .
- The mid of a linear or arc span within another vector object. This is shown by the cursor changing to a .
- The centre of another vector object, defined by a bounding box. This is shown by the cursor changing to a .





---

**Tip:** If you hold down the **X** key on your keyboard, the cursor also changes to  where two vector objects intersect.



---

- The point at which two guidelines intersect. This is shown by the cursor changing to a .
- A horizontal guideline. This is shown by the cursor changing to a .
- A vertical guideline. This is shown by the cursor changing to a .
- Directly above or below the X co-ordinate of a polyline's Start Point (node). This is shown by the  cursor changing to a .

Directly above or below the Y co-ordinate of a polyline's Start Point (node). This is shown by the  cursor changing to a .



---

**Note:** The  and  cursors only appear when you are creating polylines. For details, see "Creating a Polyline" in the Working with Vectors chapter.

---

---

# 3D View Manipulation

You can change the view of a model using the tools above the **3D View** window:

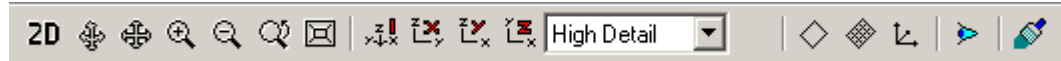

## **2D View**

Click on the **2D View** button  to display the **2D View** window.





**Note:** You can also move from the **3D View** to the **2D View** window by pressing the **F2** key on your keyboard.

---



## **Twiddle Tool**

The **Twiddle Tool** button  allows you to rotate the model around a central point, adjust the viewpoint (pan) and zoom in on or out from the current viewpoint.



To rotate the model:

1. Click on the **Twiddle Tool** button .
2. Move the  cursor over the model, click and hold down the left mouse button, and then drag the model to the required viewing angle.

To pan the model:

1. Click on the **Twiddle Tool** button .
2. Move the  cursor over the model, click and hold down both mouse buttons, and then drag the model to the required viewing position.

To zoom in on the model:

1. Click on the **Twiddle Tool** button .
2. Move the  cursor over the model, click and hold down the right mouse button, and then drag upwards.
3. Release the mouse button to set the viewpoint.



To zoom out from the model:

1. Click on the **Twiddle Tool** button .

2. Move the  cursor over the model, click and hold down the right mouse button, and then drag downwards.
3. Release the mouse button to set the viewpoint.

## **Pan View**

The **Pan View** button  allows you to adjust the viewing position of the model:

1. Click on the **Pan View** button .
2. Move the  cursor over the model, then click and drag the model into the required viewing position.





---

**Note:** You can also use the **Twiddle Tool** to adjust the viewpoint of a model. For details, see " Twiddle Tool" on page 27.

---

## **Zoom**

You can use the **Zoom** button  to zoom in on a defined area of the model:

1. Click on the **Zoom** button , then move the magnifying cursor  over the area of the model that you want to zoom in on.
2. Click and drag the mouse to create a bounding box around the area of the model that you are interested in.
3. Release the left mouse button to view the area defined by the bounding box.



---

**Note:** You can also use the **Twiddle Tool** to zoom in on the model shown in the **3D View** window. For details, see " Twiddle Tool" on page 27.

---

## **Zoom Out**

Click on the **Zoom Out** button  to reduce the size of the image by 50%.

## **Previous View**

Click on the **Previous View** button  to restore the previous zoom setting.

## **Scale To Fit**

The **Scale To Fit** button  resizes the model so that it fits in the **3D View** window.

## **Isometric View**

The **Isometric View** button  displays the model in the standard isometric view. The viewing angle is shown by the XYZ representation on the button.

## **View Along X**

The **View Along X** button  displays the model from the X-axis.

## **View Along Y**

The **View Along Y** button  displays the model from the Y-axis.

## **View Along Z**

The **View Along Z** button  displays the model from the Z-axis.

## **Select Relief Detail**

Click on the **Select Relief Detail** list box to display the list of options you can use when colour shading the relief, and then click on the option that you want to use:

- **Low Detail** – Select this option to colour shade the relief at a quarter of the model's pixel resolution.
- **Medium Detail** – Select this option to colour shade the relief at half of the model's pixel resolution.
- **High Detail** – Select this option to colour shade the relief equal to the model's pixel resolution. This option produces excellent visual clarity, but can mean that the relief takes longer to render.

## ◇ Draw Zero Plane

Click on the **Draw Zero Plane** button  to hide the zero level of the relief from view.

If you want to display the zero level of the relief, click on the **Draw Zero Plane** button  again.

## ▣ Draw X Y

Click on the **Draw X Y** button  to draw vertical lines across the relief. Horizontal lines are drawn across the relief by default.

*Draw X Y Off...*

*Draw X Y On...*

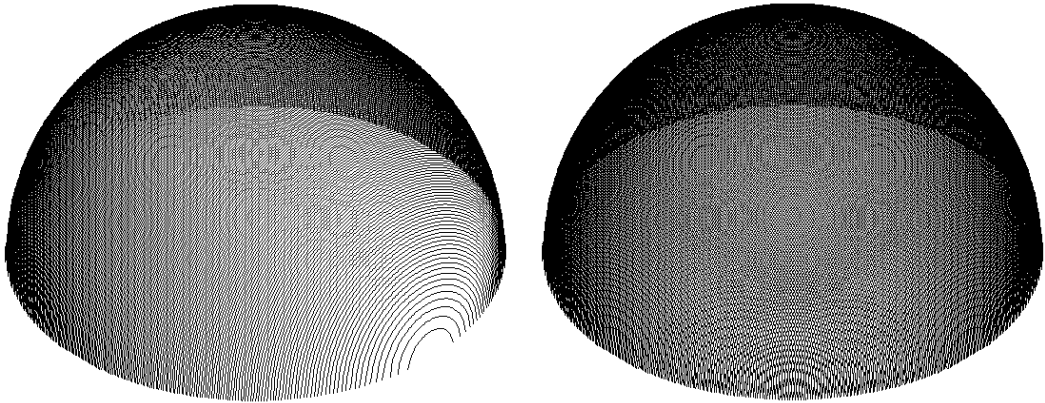

## ↖ Origin

Click on the **Origin** button  to display/hide the origin in the **3D View** window. The X-axis is red, the Y-axis is green and the Z-axis is blue.

## ▶ Objects To Draw

Click on the **Objects To Draw** button  to display the **Objects To Draw** list box. The **Objects To Draw** list box lists the block of material, the relief, all of your calculated toolpaths and all of your toolpath simulations:

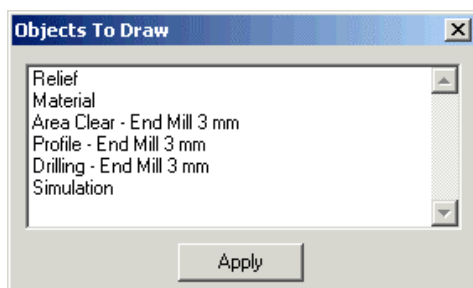



All items shown in the **3D View** window are highlighted in blue in the **Objects To Draw** list box. If an item is not highlighted, it is not shown in the **3D View** window.

You can hide any of the objects displayed in the **3D View**:

1. Click to select the object in the list box that you want to hide. The selected object is no longer highlighted in blue.
2. Click on the **Apply** button to show the object in the **3D View** window.
3. Click on the  icon in the top right corner of the **Objects To Draw** list box to close it.

To show any of the hidden objects in the **3D View**:

1. Click to select the object in the list box that you want to show. The selected object is now highlighted in blue.
2. Click on the **Apply** button to show the object in the **3D View** window.
3. Click on the  in the top-right corner of the **Objects To Draw** list box to close it.

## **Colour Shade**

Click on the **Colour Shade** button  to replace the relief or toolpath simulation with a colour shaded view.

---

## 3D View Options



You can choose whether ArtCAM Pro itself, or a graphics accelerator card using a set of fully Open GL compliant drivers, is used for shading the **3D View** window.

To adjust the 3D view options in ArtCAM Pro:

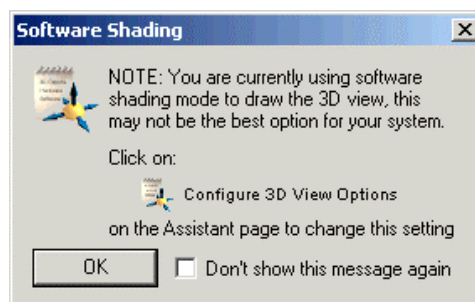
1. Start ArtCAM Pro. The **Software Shading** message box appears:



If you do not want this message box to appear the next time that you start ArtCAM Pro, click to select the **Don't show this message again** option. Click on the **OK** button to close the message box.

2. Click on the **Configure 3D View Options** icon  at the bottom of the **Assistant's Getting Started** page to display the **3D View Options** page.
3. Click on either of the **Open GL Drawing Mode** radio buttons  to select the method of shading that you want ArtCAM Pro to use when rendering your 3D models:

- **Software Shading** – Select this option  if you want ArtCAM Pro to shade a model using its own algorithms, independent of the graphics card that you have installed.

If you have a fast processor installed alongside a relatively poor graphics card (common on high-end notebooks), you should select this option.

If you select this option, ArtCAM Pro re-renders the model every time the viewpoint is adjusted or the model is changed in any way.

- **Complete Open GL Support** – Select this option  if you want ArtCAM Pro to shade a model using small triangles.

This option should only be selected if you have a fast processor, a graphics accelerator card and a set of fully compliant Open GL drivers installed. For example, NVIDIA's GeForce2 Ultra, GeForce 3 Graphics Processing Unit (GPU) or higher.

If you select this option, the model is always shaded. It also produces very fast rendering times and excellent visual clarity.



---

**Warning:** Many graphics accelerator cards have a limited subset of Open GL, used only to meet the system requirements of selected games. Please check with the manufacturer of your graphics accelerator card to confirm that it is fully Open GL compliant before selecting this option.

---

The size of the triangles that ArtCAM Pro uses to render a model in the **3D View** window is controlled

by the list box in the **3D View** toolbar. The higher the detail, the smaller the triangles that are used. For details, see "3D View Manipulation" on page 27.

4. Click on the **Apply** button to confirm your **3D View** settings.
5. Click on the **Close** button to close the **3D View Options** page and return to the **Assistant's Getting Started** page.

You can also display the **3D View Options** page in the following way:

1. From the Main menu bar, click on the **Window** menu, and then on the **3D View Options** option.

If you attempt to change the **Open GL Drawing Mode** while a model is open in ArtCAM Pro, the following message box appears:

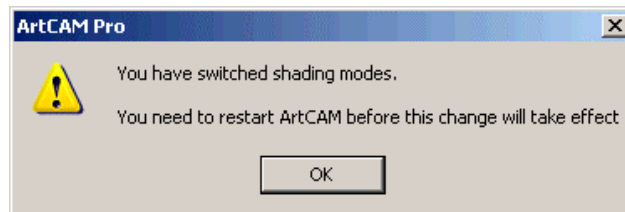

Click on the **OK** button to close the message box, then shut down and restart ArtCAM Pro for the new **Open GL Drawing Mode** to take effect. For further details, see "Shutting Down ArtCAM Pro" in the Working with Models chapter.

---

## Using the Top Toolbar

You can hide or view the Top toolbar which contains the **File**, **Model**, **Bitmap**, **Vector**, **Vector Editing**, **Vector Merging**, **Relief** and **Relief Editing** toolbars.

Hiding the Top toolbar increases the size of the central area of the screen, which in turn allows you to increase the size of the design windows.

If the Top toolbar is hidden, you can still access the options on the **File**, **Model**, **Bitmap**, **Vector**, **Vector Editing**, **Vector Merging**, **Relief** and **Relief Editing** toolbars from the Main menu bar. The Top toolbar is shown by default.

To hide the Top toolbar:

- From the Main menu bar, click on the **Window** menu, and then on the **Show Top Toolbar** option.

To view the Top toolbar:

- From the Main menu bar, click on the **Window** menu, and then on the **Show Top Toolbar** option.

---

## Updating ArtCAM Pro

ArtCAM Pro customers have the option to purchase maintenance along with their software. Maintenance is a contract between you the customer, Delcam plc and your reseller. Having a valid maintenance contract ensures that you always have access to the most up-to-date version of the software, with the most advanced functionality helping you stay competitive and get the most from your software investment.

Delcam plc are committed to releasing a new major version of ArtCAM Pro containing new features and functionality at least once a year. Having maintenance will ensure that you automatically receive the new versions along with any associated documentation. You will also be authorised to download useful 'plug-in' tools from the **Maintenance Download** page.

Contact your local software supplier for more information about maintenance.

All users with maintenance can check for software updates from within ArtCAM Pro:

1. From the Main toolbar, click on the **Help** menu followed by the **Check For ArtCAM Updates** option. ArtCAM Pro displays the **Maintenance** page in the **Assistant** window and searches for the *dcam.paf* file installed on your computer.

If the *dcam.paf* file cannot be found in the default location shown on the **Maintenance** page, or you are not on maintenance, the **Logon Failure** window is displayed:

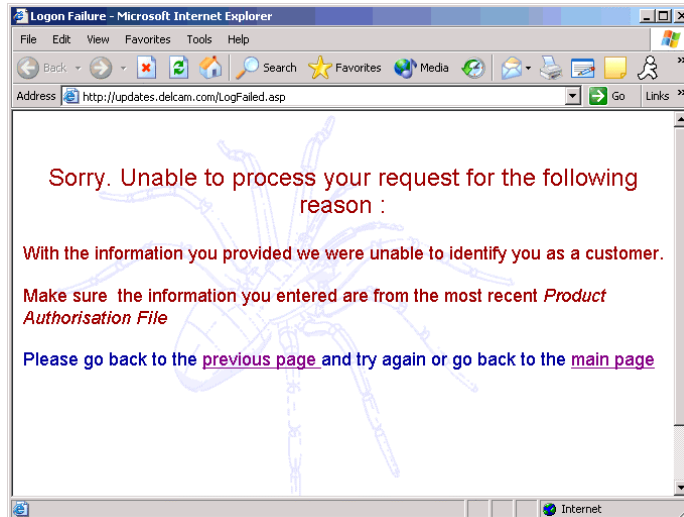

Click on the  icon in the top right corner of the window to close it. From the **Maintenance** page, you can either instruct ArtCAM Pro to search again for the *dcam.paf* file, or you can locate the file manually.

To instruct ArtCAM Pro to search again:

- Click on the **Search** button.



---

**Note:** If ArtCAM Pro fails to display the **Maintenance Download** page after locating the *dcam.paf* file, click on the **Login** button.

---

To locate the *dcam.paf* file manually:

- First, click on the **Browse** button to display the **Select PAF File** dialog box:

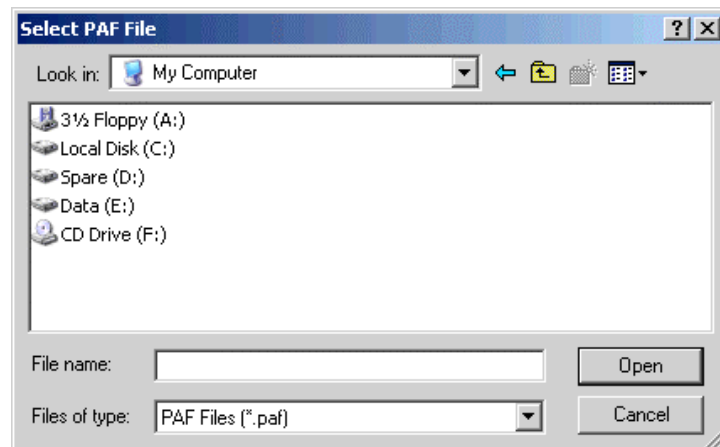

- Next, click on the **Look in** list box and select the directory in which the *dcam.paf* file is stored.

The default location is *C:\Program Files\Common Files\Delcam*

- Once you have found the *dcam.paf* file, click on its file name. Its name appears in the **File Name** area.
- Finally, click on the **Open** button to display the **Maintenance Download** page.

If the *dcam.paf* file is found and a software update is available, a window is displayed containing the **Maintenance Download** page:

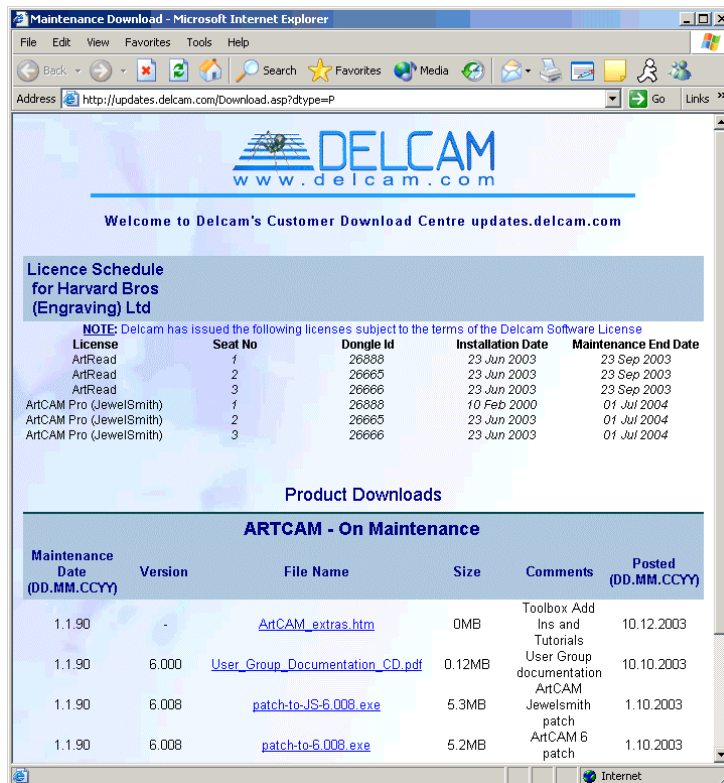

You can use this page to obtain the latest ArtCAM product downloads to which you are entitled. For example, the *ArtCAM\_extras.htm* link allows you to download a selection of new plugins for the **Add Ins** page.

If the *dcam.paf* file is found and there are no software updates currently available, the following message box appears:

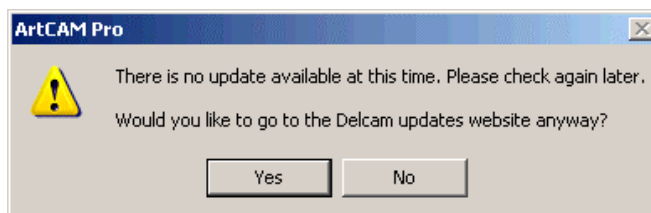

If you want to display the **Maintenance Download** page anyway, click on the **Yes** button. If you do not, click on the **No** button to close the message box.

2. Click on the **OK** button on the **Maintenance** page to return to the **Assistant's** Home page.

---

## Installing Your ArtCAM Licence

In order to use ArtCM Pro, you must ensure that you have installed a valid licence. This licence can be installed as one of two different file types: a PAFfile (*dcam.paf*) or a Delcam Licence file (*dcam.dcamlic*).

To install your ArtCAM licence:

1. From the Main menu bar, click on the **Help** menu, followed by the **Install Licence (PAF) File** option.
2. Click on the **Browse** button to display the **Select Licence File To Install...** dialog box:

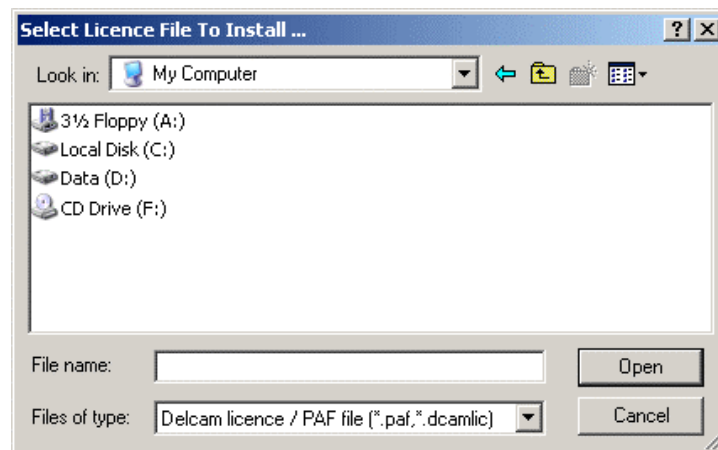

3. Click on the **Look in** list box and select the directory in which the licence file is stored. The default location is *C:\Program Files\Common Files\Delcam*
4. Once you have found the licence file, click on its file name. This appears in the **File Name** area.
5. Click on the **Open** button to install the file.

---



## Managing ArtCAM Pro's Preferences

Many of the default settings in ArtCAM Pro can be controlled from one central location. Using the **ArtCAM Options** page, you can:

- Choose the colours associated with vector objects used to indicate their current state.
- Define the speed at which the relief rotates in the **3D View** window when spun.

- Define the default settings used for machining strategies within 2D and 3D toolpaths.
- Instruct ArtCAM Pro to check for or ignore self-intersections in imported vector artwork.
- Control the increments used in ArtCAM Pro.
- Control the size of the design windows when ArtCAM Pro is started.
- Set the size of text information shown in the **2D View** window.
- Save reliefs in the same directory as the ArtCAM model file in which they were created by default.
- Choose the colours for the greyscale image of the current relief show in the **Greyscale View** and how they are blended.
- Control the size of the 'scratch' file associated with the **Undo** and **Redo** buttons.

To adjust the aforementioned display settings in ArtCAM Pro:

1. Click on the **File** tab  in the Main toolbar to display the **File** toolbar.
2. Click on the **Options** button  to display the **ArtCAM Options** page. The default colours and settings currently used in ArtCAM Pro are shown on the page.
3. In the **2D Drawing Colours** area, click on the  arrow to display its settings:
  - To change the colour associated with a selected ungrouped vector object, click on the current **Selected** colour to display the **Color** dialog box:



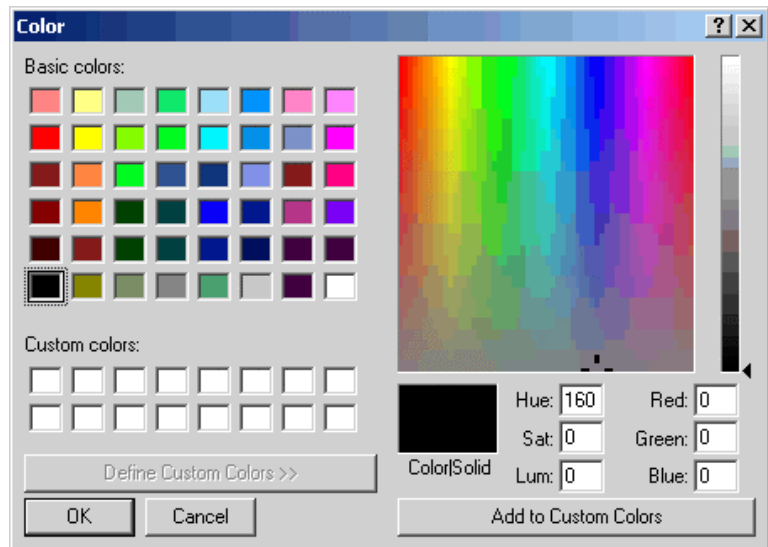



For details on how to select a colour, see "Assigning a Colour to a Layer" in the Working with Models chapter.

- To change the colour associated with two or more selected ungrouped vector objects, click on the current **Multiple Selected** colour to display the **Color** dialog box. For details on how to select a colour, see "Assigning a Colour to a Layer" in the Working with Models chapter.
- To change the colour associated with two or more overlapping vector objects, click on the current **Overlapping** colour to display the **Color** dialog box. For details on how to select a colour, see "Assigning a Colour to a Layer" in the Working with Models chapter.
- To change the colour associated with 2D toolpath previews, click on the current **Toolpath Preview** colour to display the **Color** dialog box. For details on how to select a colour, see "Assigning a Colour to a Layer" in the Working with Models chapter.
- To change the colour associated with a selected grouped vector object, click on the current **Selected** colour in the **Grouped** area to display the **Color** dialog box. For details on how to select a colour, see "Assigning a Colour to a Layer" in the Working with Models chapter.
- To change the colour associated with locked vector objects when selected, click on the current **Selected**

colour in the **Locked** area to display the **Color** dialog box. For details on how to select a colour, see "Assigning a Colour to a Layer" in the Working with Models chapter.

- To change the colour associated with locked vector objects when deselected, click on the current **Unselected** colour in the **Locked** area to display the **Color** dialog box. For details on how to select a colour, see "Assigning a Colour to a Layer" in the Working with Models chapter.
4. In the **3D View** area, click on the  arrow to display its settings:
    - To change the frame rate at which a relief or triangle model in the **3D View** window rotates when spun, define the new speed in the **Spin Update Rate** box. For details on how to rotate a relief or triangle model, see "Rotating a Relief or Triangle Mesh" in the Working with Reliefs chapter.
  5. In the **Machining** area, click on the  arrow to display its settings:
    - Climb Milling rotates the toolbit in the same direction as the feed motion. To set climb milling as the default cutting direction used in toolpaths, click to select the **Use Climb Milling by Default** option .
    - A raster machining strategy machines in passes back and forth along a specified angle. To set the default angle for toolpaths that use a raster machining strategy, type the angle in the **Default Raster Angle** box.
    - When using an offset machining strategy in a toolpath, machining inwards from the outside edge of the block of material by default, click to select the **Start Offset Machining at Edge** option .
    - If you are machining small areas of material with very fine detail, click to select the **Use Engraving Engine for Area Clear** option . Other than using the Engraving engine for Area Clearance toolpaths, this option adds tails to remove up-stands when the

stepover is greater than the tool radius. This option is deselected by default.

- To show the cutting direction in all 2D toolpath previews shown in the **2D View** window, click to select the **Cutting Direction** option .
  - ArtCAM Pro shows rapid and plunge moves in all simulated toolpaths by default. To hide all rapid and plunge moves, click to deselect the **Rapid & Plunge Moves** option .
6. In the **File Import** area, click on the  arrow to display its settings:
- ArtCAM Pro identifies all self-intersections within imported vector artwork by default. To ignore any self-intersections, click to deselect the **Check for Crossings** option .





---

**Note:** You can use the **Vector Doctor** tool  to check for self-intersections in vector artwork. For details, see "Using the Vector Doctor" in the Working with Vectors chapter.

---

7. In the **Text Defaults** area, click on the  arrow to display its settings. These settings allow you to control the default increments used in the **Size** and **Transform** areas of the **Text Tool** page and the **Text Position** area of the **Text on a Curve** page in ArtCAM Pro:
- In the **Point spin increment** box, define the incremental value used between each click on either the **▲** or **▼** arrow whenever the **points** option is selected. This option is set to 3 points by default.
  - In the **MM spin increment** box, define the incremental value used between each click on either the **▲** or **▼** arrow whenever the **mm** option is selected. This option is set to 1 mm by default.
  - In the **Inches spin increment** box, define the incremental value used between each click on either the **▲** or **▼** arrow whenever the **inches** option is selected. This option is set to 0.04 inches by default.
8. In the **2D Drawing Options** area, click on the  arrow to display its settings:

- ArtCAM Pro replaces a selection of points (nodes) with a single vertical or horizontal linear span by default. To align a selection of points (nodes) with either the X or Y axis whilst preserving the points, click to deselect the **Align Nodes – replace with a single line** option .
  - To set the size of the text information shown in the **2D View** window, such as the numbers and letters displayed when creating a Two Rail Sweep, type the point size of the font in the **pt** box. A default size of 15 points is used.
9. In the **Miscellaneous** area, click on the  arrow to display its settings:
- To maximise both of the design windows when ArtCAM Pro is started, click to select the **Maximise Views on Startup** option .
  - To save a relief file (\*.rlf) in the same directory as the ArtCAM model file (\*.art) from which it was created, click to select the **Save Reliefs in Art File Directory** option .
10. In the **Greyscale View** area, click on the  arrow to display its settings:
- To change the colour of the relief's zero plane, click on the current **Base Colour** to display the **Color** dialog box. For details on how to select a colour, see "Assigning a Colour to a Layer" in the Working with Models chapter.
  - To change the colour of the lowest points in the relief, click on the current **Lowest Colour** to display the **Color** dialog box. For details on how to select a colour, see "Assigning a Colour to a Layer" in the Working with Models chapter. ArtCAM Pro blends the relief from this colour to the colour selected for its highest points.
  - To change the colour of the highest points in the relief, click on the current **Highest Colour** to display the **Color** dialog box. For details on how to select a colour, see "Assigning a Colour to a Layer" in the Working with Models chapter.

- If you do not want ArtCAM Pro to use a linear blend for the colours selected for the lowest and highest points in the relief, click to deselect the **Linear colour blend** option . When deselected, this option produces a more detailed view of the higher points in the relief.

11. In the **Scratch File Settings** area, define the amount of space that you want to allocate on your computer to the temporary scratch file. The default size is 100mb.

The scratch file is stored in the Temp directory associated with the User currently logged-in to Windows. For example, *C:\Documents and Settings\<user>\Local Settings\Temp*.

12. Click on the **Apply** button to confirm your settings.

If you want to restore the default settings at any time, click on the **Reset** button.

13. Click on the  icon to return to the **Assistant's** Home page.



---

**Note:** You can also click on the  icon at the top of the page to return to the **Assistant's** Home page.

---



# Working with Models

---

## Getting Started

When you start ArtCAM Pro, the **Assistant's Getting Started** page is displayed. This page is divided into three areas:

- **Create Model** – This allows you to define the dimensions of a block of material or select an image file from which you want to produce an ArtCAM model. For details, see "Creating a Model" on page 45.
- **Open Model** – This allows you to open ArtCAM model files that you have already created. For details, see "Creating a Model from an Image" on page 47.
- **Other Features** – This allows you to create your own or edit existing fonts for use within ArtCAM Pro's **Text Tool**, create a relief from a photographic image containing a side-profile of a person's head and neck, and display details of the latest features available in ArtCAM Pro. For details, see "Using the Font Editor" on page 116 and "Using the Face Wizard" on page 122.

## Creating a Model

To create a model:

1. Click on the **Create New Model** icon  on the **Assistant's Getting Started** page to display the **Size For New Model** dialog box:

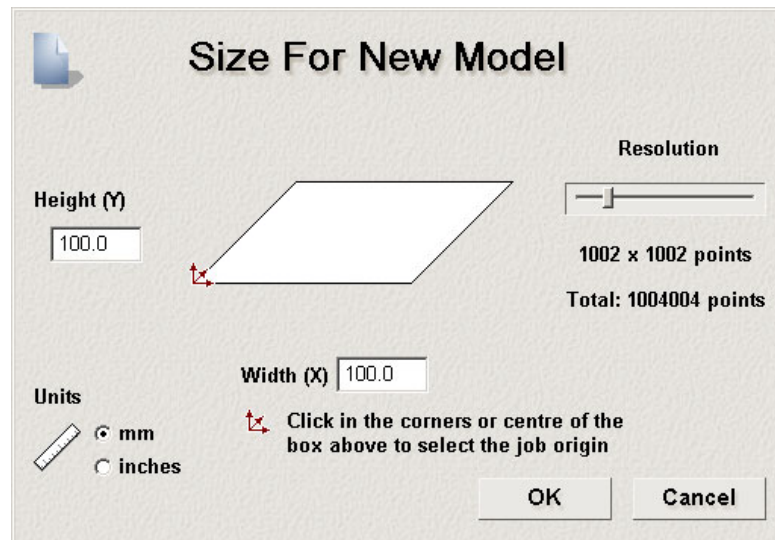



---

**Note:** You can also display the **Size For New Model** dialog box by pressing the **Ctrl + N** keys on your keyboard.

---

2. Define the **Height (Y)** and **Width (X)** according to the physical size of the model you want to create.
3. Click on the centre or any of the four corners of the box to define the X-axis zero and Y-axis zero origin.

The **Job Origin** icon  appears in the position you have clicked on.

4. Click and drag on the slider to set the **Resolution** of your model.

Drag the slider to the right to increase the resolution of the model. Drag the slider to the left to decrease it. Generally, a resolution of approximately 1,000,000 points is reasonable to work at.

5. Make sure that the **Units** option is set according to those in which you are working, either millimetres or inches.
6. Click on the **OK** button to display a **2D View** and a **3D View** window.

The **2D View** window is the area in which you draw or import the bitmap images and vector objects, and import or create the reliefs, that make up your model. The **3D View** window is the area in which you can view a three-dimensional impression of your model.

The model has a single default layer. For details, see "Creating a New Layer" on page 110.





---

**Note:** You can create a new model at any time by clicking on the **New Model** button  in the **File** area of the **Assistant's** Home page.

---

## Creating a Model from an Image

You can create a model by importing any the following types of image files into ArtCAM Pro: Bitmap (\*.bmp), TIFF (\*.tif) GIF (\*.gif) and JPEG (\*.jpg). ArtCAM Pro calculates a relief from the imported image.

To create a model from a saved image file:

1. Click on the **Create Model From Image** icon  on the **Assistant's Getting Started** page to display the **Load Photograph** dialog box.
2. Click on the **Look in** list box and select the directory where the image file from which you want to create a model is stored.
3. Click to select the image file from which you want to create a model. The file name appears in the **File name** box.
4. Click on the **Open** button to display the **Set Model Size** dialog box:

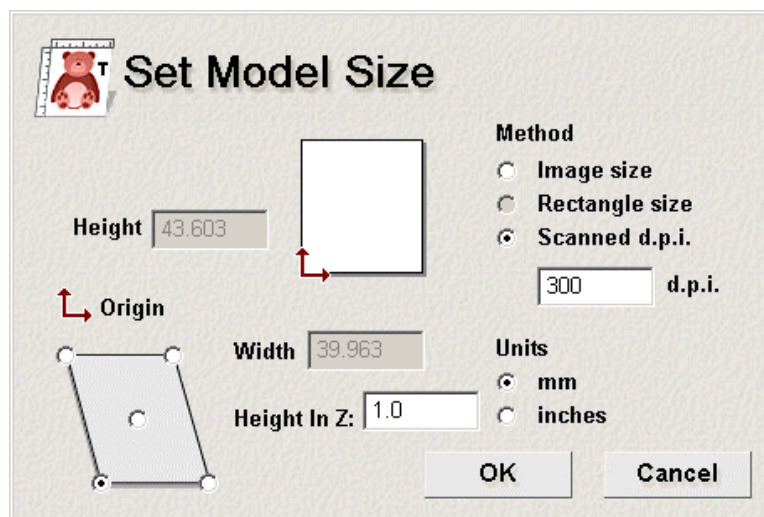

5. Make sure that the **Units** option is set according to those in which you are working, either millimetres or inches.

6. If you know the resolution (dpi) at which the image was originally scanned, type this value in the **d.p.i.** box. If you do not, go straight to the next step.
7. You are now ready to set the size of the image. In the **Method** area, click to select the **Image size** radio button .
8. Define the height (Y) of the model in the **Height** box.
9. Define the width (X) of the model in the **Width** box.
10. In the **Height In Z** box., define the maximum depth of the relief that you want to allow ArtCAM Pro to calculate from the image.



---

**Tip:** If you use an image with a high Z height, the resulting relief detail is likely to be poor. You should only use images with a low Z height, such as textures.

---



---

**Note:** The default value in the **Height In Z** box is 1.0 irrespective of the units you are using. Make sure the Z height is correct.

---

11. Define the X-axis zero and Y-axis zero origin in the model. For further details, see "Editing the Model Dimensions" on page 62.
12. Click on the **OK** button to close the **Set Model Size** dialog box and create your model. The model has a single default layer. For details, see "Creating a New Layer" on page 110.



---

**Note:** If you have imported a colour image file, it is displayed as a greyscale image in the **2D View** window.

---



---

**Note:** You can also create a new model from a saved image file (\*.bmp, \*.tif, \*.gif or \*.jpg) using the **File > New (From Image)** option from the Main menu bar.

---

## Opening an Existing Model

To open a model that you have previously saved:

1. Click on the **Open Existing Model** icon  on the **Assistant's Getting Started** page to display the **Open** dialog box:

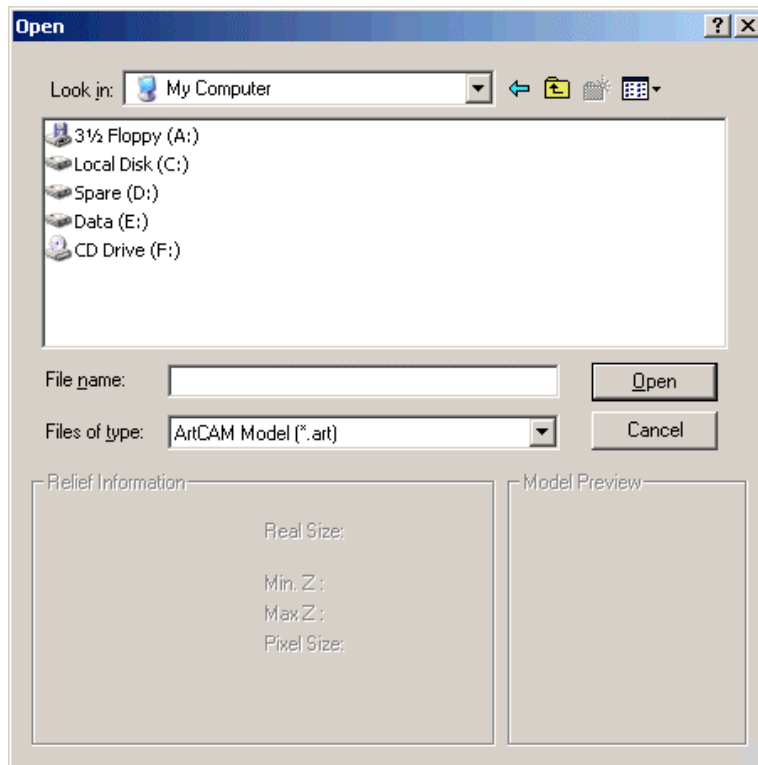

**Note:** You can also display the **Open** dialog box by pressing the **Ctrl + O** keys on your keyboard.

2. Click on the **Files of type** list box, and then on the file type of the model you want to open.



**Note:** You can open a model saved as an **\*.art**, **\*.bmp**, **\*.tif**, **\*.pcx**, **\*.gif**, **\*.jpg**, **\*.rlf**, **\*.dxf** and **\*.dwg** file only.

3. Click on the **Look in** list box and select the directory where the model file that you want to open is stored.
4. Once you have found the model file, click on its file name.
5. Click on the **Open** button to open the model.



**Note:** You can also click on the **Open File** button  in the **File** area of the **Assistant's** Home page to open a model when already working on another.

## Opening Recent Models

If you want to open a model that you were working on recently:

1. From the **Assistant's Getting Started** page, click on the  icon beside the correct ArtCAM model file name.



---

**Tip:** You can also open previously saved models by clicking on the **File** menu in the Main menu bar, and then on the appropriate file name listed above the **Exit** option. Up to five models are listed.

---

## Viewing Model Information



You can use the **Project** page to view information about the ArtCAM model on which you are currently working.





To view details of the model on which you are working on:

- Click on the **Project** tab  to display the **Project** page in the **Assistant** window.

The **Project** page contains a tree that is divided into four model elements.

The  icon denotes the root of the tree. If the current ArtCAM model has been saved, the name of the model file is shown beside this icon.

You can display details about a model element by clicking on the  icon, or you can hide them by clicking on the  icon. The four model elements shown within the Project tree are as follows:

-  **Artwork** – This element details the model dimensions.
-  **Views** – This element details all of the open design windows within the model.
-  **Relief** – This element details the relief dimensions within the model, its minimum and maximum height and its origin.
-  **Machining** – This element details the thickness of the material block and all of the toolpaths that you have calculated.

## Closing a Model

To close the ArtCAM Pro model that you are currently working on, you can either:

- Click on the  icon on the top-right corner of each of the open **2D View** windows; or

- From the Main menu bar, click on the **File** menu, followed by the **Close** option.

If you close a new model before saving it, or close a previously saved model before saving any changes you have made, the following message box appears:

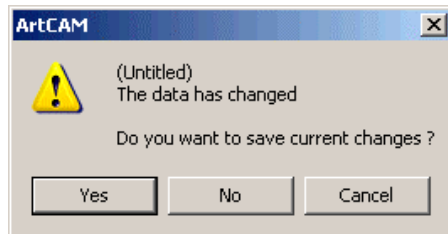

If you want to save the model:

1. Click on the **Yes** button to open the **Save As...** dialog box. For further details, see "Saving a Model" on page 55.

If you do not want to save the model you are working on:

1. Click on the **No** button to close the message box and return to the **Getting Started** page.

## Shutting Down ArtCAM Pro

To shut down ArtCAM Pro:

1. From the Main menu bar, click on **File** menu, followed by the **Exit** option.

If you click on the **Exit** option before saving a changed model, the following message box appears:

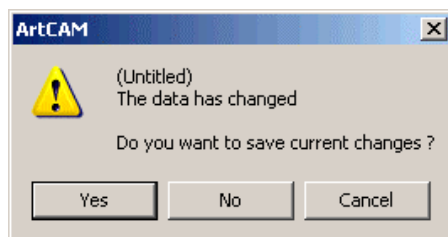

If you want to save the model:

1. Click on the **Yes** button to open the **Save As...** dialog box. For further details, see "Saving a Model" on page 55.

If you do not want to save the model you are working on:

1. Click on the **No** button to close the message box and return to the **Getting Started** page.

---

# Managing a Model

When you have created or opened a model in ArtCAM Pro, the **Assistant's** Home page is displayed.

You can use the buttons in the **File** and **Model** areas of the **Assistant's** Home page to help you manage a model. All of these buttons can also be found on the **File** and **Model** toolbars:



Using the buttons on the **File** toolbar you can:

- Create a new model. See "Creating a New Model" on page 53.
- Open a saved model. See "Opening a Model" on page 54.
- Save an open model. See "Saving a Model" on page 55.
- Display or hide a note file attached to a model. For details, see "Using the ArtCAM Pro Notepad" on page 80.
- Import vector files created in other applications. See "Importing Vector Artwork" on page 81.
- Correct a mistake that you have made. See "Correcting an Action" on page 104.
- Open the Help for ArtCAM Pro.



---

**Note:** Click on the **Help Index** button  in the **File** toolbar to display ArtCAM Pro's Online Help.

---

- Manage the preference settings for ArtCAM Pro. For details, see "Managing ArtCAM Pro's Preferences" in the ArtCAM Pro Layout chapter.

Using the buttons on the **Model** toolbar you can:

- Edit the dimensions of a model. For details, see "Editing the Model Dimensions" on page 62.
- Set the position of a model. For details, see "Setting the Position of a Model" on page 65.

- Delete all bitmap artwork in a model. For details, see "Clearing a Model" on page 67.
- Create a greyscale image from a relief. For details, see "Creating a Greyscale Image from a Relief" on page 67.
- Add a border to a model. For details, see "Adding a Border to a Model" on page 69.
- Reduce the colours in a model. For details, see "Reducing Colours" in the Working with Bitmaps chapter.
- Adjust the lights and material settings for a relief. For details, see "Adjusting Light and Material Settings" on page 71.
- Mirror a model. For details, see "Mirroring a Model" on page 105.
- Rotate a model. For details, see "Rotating a Model" on page 105.

## Creating a New Model

To create a new model:

1. Click on the **New Model** button  in the **File** area of the **Assistant's** Home page to display the **Size For New Model** dialog box. For further details, see "Creating a Model" on page 45.





---

**Note:** You can also create a new model by pressing the **Ctrl + N** keys on your keyboard, or by clicking on the **File** menu in the Main menu bar, followed the **New...** option.

---

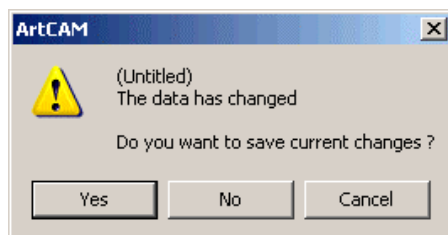
If you click on the **New Model** button  while working on an unsaved model, and then the **OK** button in the **Size For New Model** dialog box, the following message box appears:



If you want to save the model:

1. Click on the **Yes** button to open the **Save As...** dialog box. For further details, see "Saving a Model" on page 55.

If you do not want to save the model you are working on:

1. Click on the **No** button to close the message box and return to the **Getting Started** page.

## Creating a New Model Using Pixels

To create a model made up of an exact number of pixels:

1. From the Main menu bar, click on the **File > New (Specify Pixel Size)** option to display the **Size For New Image In Pixels** dialog box:

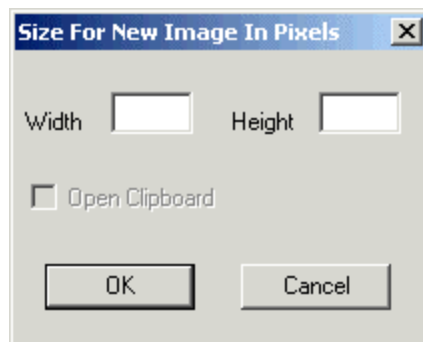

2. If you want to use the image currently on the Windows clipboard as the new model, make sure that the **Open Clipboard** option is selected .
3. In the **Width** box, define the width (X) of the model in pixels.
4. In the **Height** box, define the height (Y) of the model in pixels.
5. Click on the **OK** button to create the model.

## Opening a Model

To open a model that you have previously saved:

1. Click on the **Open File** button  in the **File** area of the **Assistant's** Home page to display the **Open** dialog box:



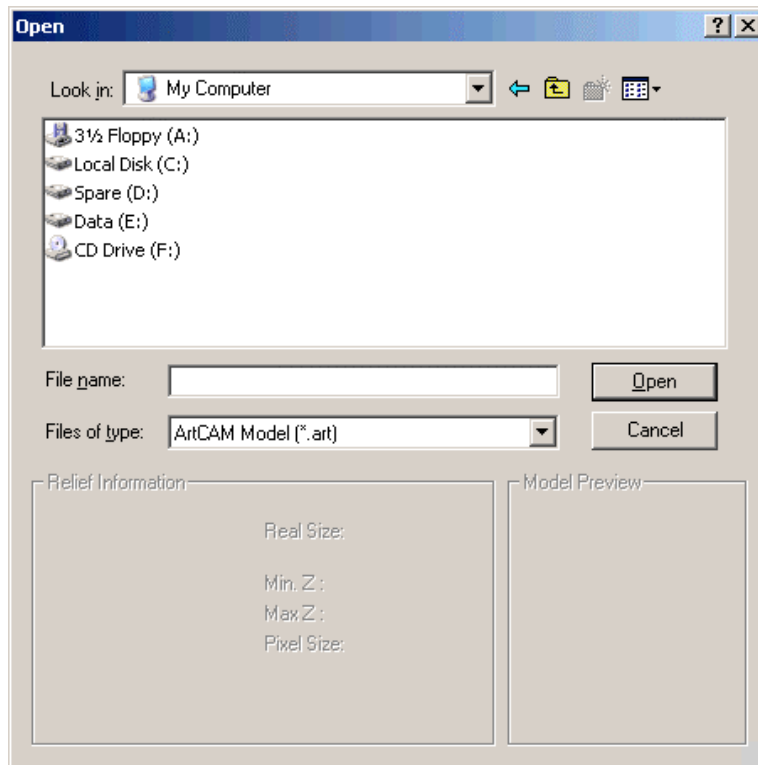

---

**Note:** You can also display the **Open** dialog box by pressing the **Ctrl + O** keys on your keyboard.

---

For further details, see "Opening an Existing Model" on page 48.

## Saving a Model

You can save a model as an ArtCAM model file (\*.art), Windows Bitmap (\*.bmp), TIFF (\*.tif), PCX (\*.pcx), GIF (\*.gif) or JPEG (\*.jpg) image.

To save the ArtCAM model you have created:

1. Click on the **Save** button  in the **File** area of the **Assistant's** Home page to display the **Save As...** dialog box:

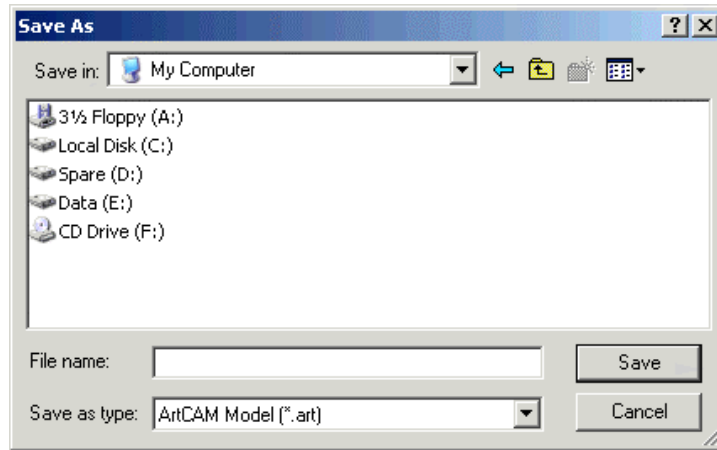

---

**Note:** You can also display the **Save As** dialog box by pressing the **Ctrl + S** keys on your keyboard, or by clicking on the **File** menu in the Main menu bar, followed the **Save As...** option.

---

2. Click on the **Save In** list box and select the directory in which you want to save the model.
3. Click on the **Save As Type** list box, and then on the file type you want to save the model as.



---

**Note:** ArtCAM Pro saves the model as an **\*.art** file by default. This is an ArtCAM proprietary file that stores not only your vector or bitmap artwork and a relief, but also any toolpaths that have been created as part of the model.

---

4. Type the file name you want to use for the model in the **File name** box.
5. Click on the **Save** button.

To save the changes you have made to a model since it was last saved:

1. Click on the **Save** button .



---

**Note:** You can also save a model if you click on **File** in the Main menu bar, and then on the **Save** option.

---

## Saving the 3D View as an Image

You can save the contents of the **3D View** window as a Windows Bitmap (**\*.bmp**), TIFF (**\*.tif**), PCX (**\*.pcx**), GIF (**\*.gif**) or JPEG (**\*.jpg**) image.

To save the model displayed in the **3D View** window as an image:

1. Click on the **3D View** window that you want to save as an image to make sure that it is active.
2. From the Main menu bar, click on the **Windows** option to display the **Windows** menu, and then on the **Save 3D View Image** option. The **Save As** dialog box appears:

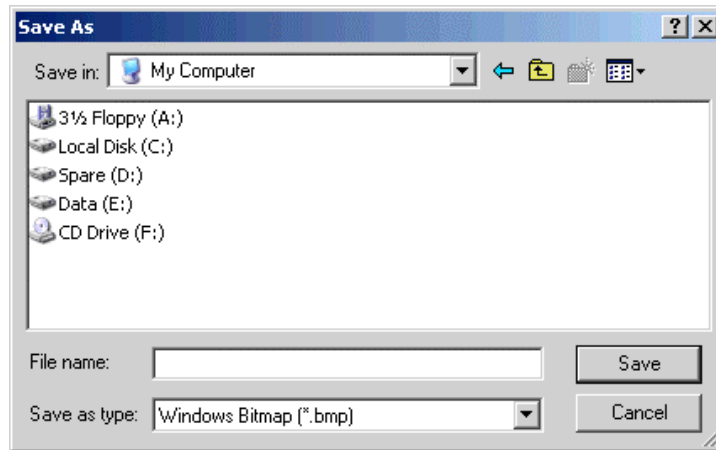

3. Click on the **Save In** list box and select the directory in which you want to save the image.
4. Type a name for the image in the **File Name** box.
5. Click on the **Save As Type** list box, and then on the image type in which you want to save the contents of the **3D View** window (\*.bmp, \*.tif, \*.pcx, \*.gif or \*.jpg).
6. Click on the **Save** button to save the image.

## Printing a Model

You can print a model as it is shown in the active design window.

To print a model:

1. Click to select the design window that you want to print.
2. From the Main menu bar, click on the **File** option, followed by the **Print** option to display the **Print Setup** dialog box:

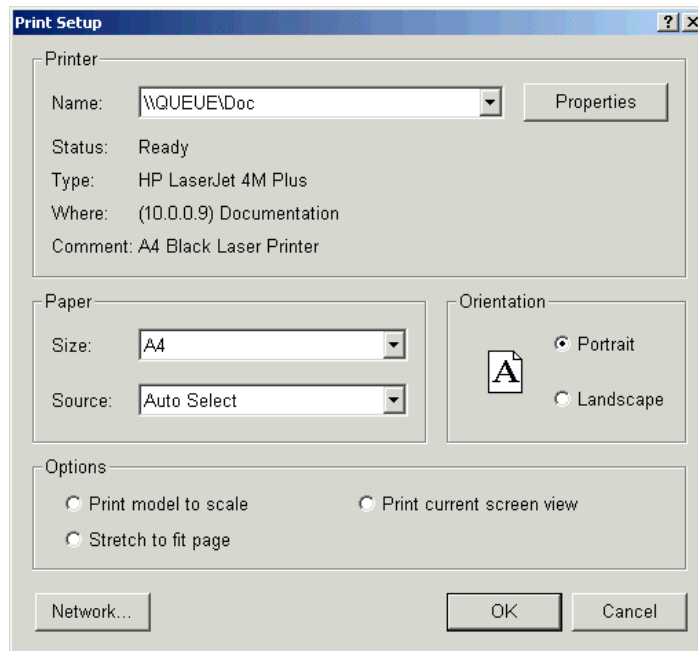

3. Make sure that your printer settings are correct. For details, see "Print Setup" on page 60.
4. In the **Options** area, click on the print option that you want to use:



---

**Note:** If you are printing the **3D View** window, the print options are automatically greyed-out. In this instance, ArtCAM Pro prints to fit the **3D View** window in its current orientation.

---

- **Print model to scale** – Click on this radio button  if you want to print the model according to its physical dimensions.  
Before printing, make sure that the model can fit on the paper onto which you are printing. For details, see "Print Setup" on page 60.
- **Stretch to fit page** – Click on this radio button  if you want to print the model according to the dimensions of the paper onto which you are printing.
- **Print current screen view** – Click on this radio button  if you want to print the model as it currently appears in the **2D View** window.

5. Click on the **OK** button to close the **Print Setup** dialog box and print the active design window.

## Print Preview

You can view the content of the active design window as it would appear when printed. This is known as a print preview.

To create a print preview:

1. Click to select the design window that you want to print.
2. From the Main menu bar, click on the **File** option, followed by the **Print Preview** option to display a preview image of the active design window:

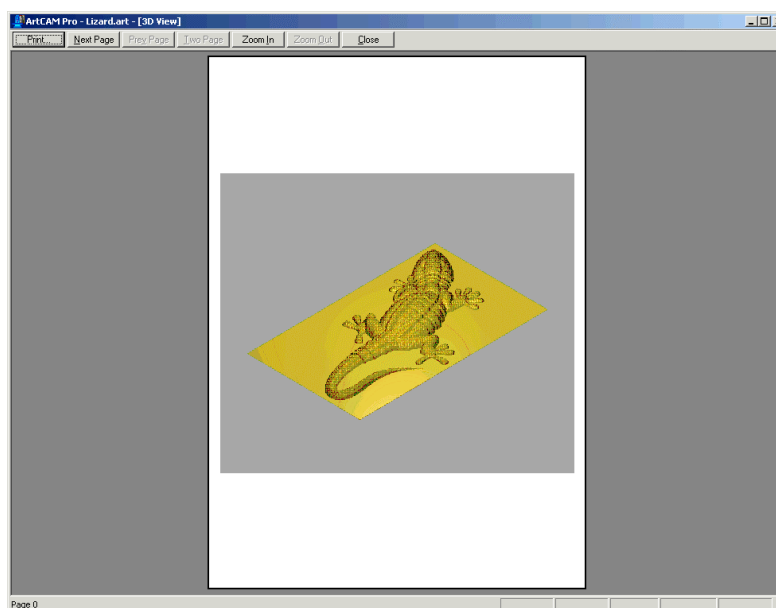

3. You can use the buttons in the bar at the top of the **ArtCAM Pro** window to view the preview image in more detail:
  - To show the next page of the preview image, click on the **Next Page** button. If this button is greyed out, there are no further pages.
  - To show the previous page in the preview image, click on the **Prev Page** button. If this button is greyed out, there are no further pages.
  - To show two pages in the preview image at the same time, click on the **Two Page** button. If this button is greyed out, there is only one page in the preview image.
  - To enlarge the size of the preview image, click on the **Zoom In** button.
  - To reduce the size of the preview image, click on the **Zoom Out** button.

4. You are now ready to print the preview image:
  - If you want to print the preview image, click on the **Print** button. For details, see "Printing a Model" on page 57.
  - If you do not want to print the preview image, click on the **Close** button.

## **Print Setup**

You can control the settings for the printer to which the content of the active design window is sent by ArtCAM Pro.

To adjust the printer settings:

1. Click to select the design window that you want to print.
2. From the Main menu bar, click on the **File** option, followed by the **Print Setup** option to display the **Print Setup** dialog box.
3. Click on the **Name** list box and then on the printer that you want to use.
4. In the **Paper** area, click on the **Size** list box and select the size of paper on which you are printing.
5. In the **Paper** area, click on the **Source** list box and then on the tray or paper feed option that you want to use when printing.
6. Select the orientation that you want to use when printing:
  - **Portrait** - Click on this radio button  if you want to print the model vertically. Typically, portrait orientation is used for models that are taller than they are wide.
  - **Landscape** - Click on this radio button  if you want to print the model horizontally. Typically, landscape orientation is used for models that are wider than they are tall.
7. In the **Options** area, click on the print option that you want to use:
  - **Print model to scale** – Click on this radio button  if you want to print the model according to its physical dimensions.

Before printing, make sure that the model can fit on the paper onto which you are printing.

- **Stretch to fit page** – Click on this radio button  if you want to print the model according to the dimensions of the paper onto which you are printing.
- **Print current screen view** – Click on this radio button  if you want to print the model as it currently appears in the **2D View** window.



---

**Note:** If you are printing the **3D View** window, the print options are automatically greyed-out. In this instance, ArtCAM Pro prints to fit the **3D View** window in its current orientation.

---

8. Click on the **OK** button to print the active design window and close the **Print Setup** dialog box.

## Importing Images

In ArtCAM Pro, you can use image files created in other drawing packages as part of a model.

If you want to import an image saved as a Bitmap (\*.bmp), TIFF (\*.tif), PCX (\*.pcx), GIF (\*.gif) or JPEG (\*.jpg) into a model:

1. Click on the **Open** option from the **File** menu to display the **Open** dialog box:

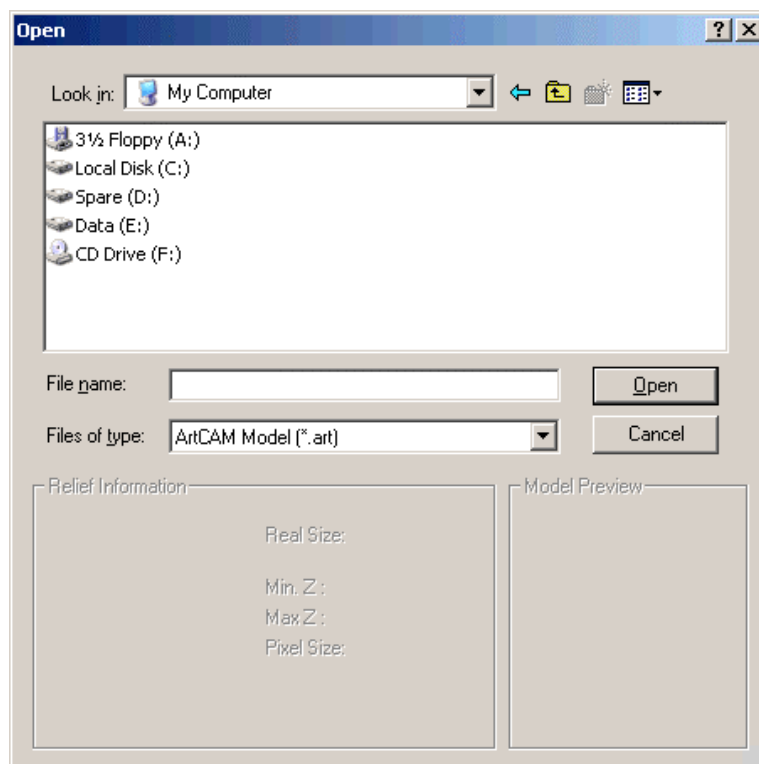



2. Click on the **Files of type** list box, and then on the image file type that you want to import.
3. Click on the **Look In** list box and find the image file that you want to import.
4. Once you have found the image file, click to select the file listed in the main window of the **Open** dialog box. Its name appears in the **File Name** box.
5. Click on the **Open** button to import the image file into ArtCAM Pro.

## Editing the Model Dimensions

To edit the dimensions originally defined for a model when it was created:

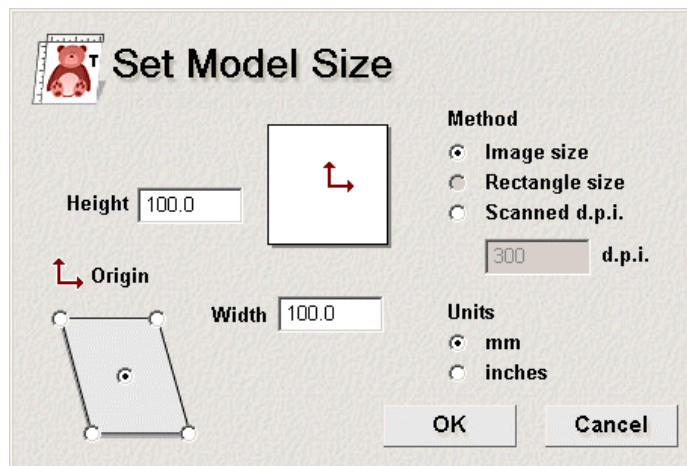
1. Click on the **Set Model Size** button  in the **Model** area of the **Assistant's** Home page to display the **Set Model Size** dialog box:



2. In the **Method** area, click on the appropriate radio button  according to how you want to set the new size of the model. If you have selected the **Image Size** method:
  - In the **Height** and **Width** boxes, define the new height and width according to the physical size of the model you want to create.



---

**Warning:** If you have not created a selection rectangle before clicking on the **Set Model Size** button, the **Rectangle Size** option is greyed out. For details, see "Using the Selection Rectangle" on page 78.

---



If you have selected the **Rectangle Size** method:

- The dimensions of the selection rectangle that you have drawn are displayed in the **Height** and **Width** boxes.

If you have selected the **Scanned d.p.i.** method:

- Define the resolution that you want use for the model in the **d.p.i.** box.



---

**Note:** Reducing the dots per inch increases the size of the model.

---

3. In the **Origin** area, click on the centre or any of the four corner radio buttons  to define the X-axis zero and Y-axis zero origin.
4. Make sure that the **Units** option is set according to those you in which you are working (millimetres or inches).
5. Click on the **OK** button to set the size of the model according to the defined dimensions.

## Editing Asymmetrical Dimensions in a Model



---

**Warning:** Editing the asymmetrical dimensions of a model only affects the size of a relief within it.

---

You can edit any asymmetrical dimensions that you find in a model.

To edit a model's asymmetrical dimensions:

1. From the Main menu bar, click on the **Model > Set Size Asymmetric** option to display the **Specify Model Size** dialog box:

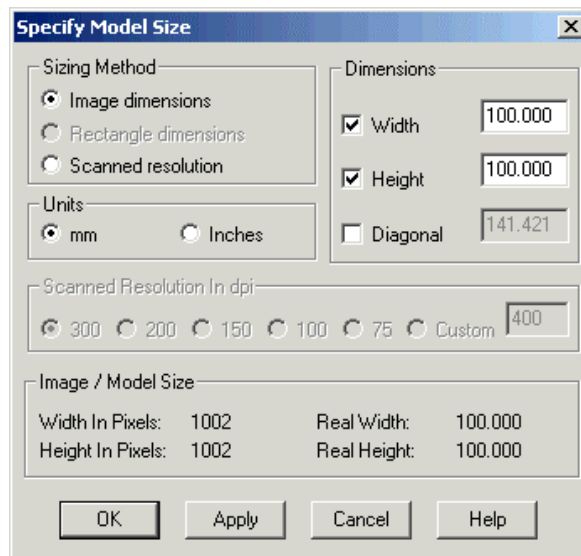

2. Click on the **Sizing Method** radio button  that you want to use:
  - **Image dimensions** – This option allows you to set the size of a model using specific measurements.
  - **Rectangle dimensions** – This option allows you to set the size of a model to an area defined by a Selection Rectangle. For details, see "Using the Selection Rectangle" on page 78.
  - **Scanned resolution** – This option allows you to set the size of a model by defining the size of a pixel within it.
  
3. If you have selected the **Image dimensions** or the **Rectangle dimensions** option:
  - To define both the **Width** (X) and the **Height** (Y) as a specific size, make sure that both of these options is selected  in the **Dimensions** area, and then type the measurement in each of the boxes.
  - To preserve the ratio between the **Width** (X) and the **Height** (Y) of the model, make sure that only one of these options is selected  in the **Dimensions** area, and then type the measurement in the adjacent box.  
 All other boxes in the **Dimensions** area are automatically greyed out when only one of the available options is selected .
  - To define the distance between the origin and the top right corner of the model, make sure that only the

**Diagonal** option is selected  in the **Dimensions** area, then type the measurement in the adjacent box.

If you have selected the **Scanned resolution** option:

- Click on one of the radio buttons  in the **Scanned Resolution in d.p.i.** area to define the size of a pixel in the model.



---

**Note:** Reducing the dots per inch increases the size of the model.

---

4. Make sure that the **Units** option is set according to those in which you are working (millimetres or inches).

5. Click on the **Apply** button to preview the new model size.

The **Real Height** and **Real Width** values in the **Image/Model Size** area are updated according to your new dimensions.

6. Click on the **OK** button to set the size of the model.

## Setting the Position of a Model

You can define the position of the X-axis zero and Y-axis zero origin as one of five pre-defined locations using the **Set Model Size** dialog box. For details, see "Editing the Model Dimensions" on page 62.

To define the position of the X-axis zero and Y-axis zero origin as somewhere other than the five available locations in the **Set Model Size** dialog box, you can use the **Set Position** dialog box. You can also define the Z-axis zero origin using the **Set Position** dialog box.

To set the position of a model:

1. Click on the **Set Model Position** button  in the **Model** area of the **Assistant's** Home page to display the **Set Position** dialog box:

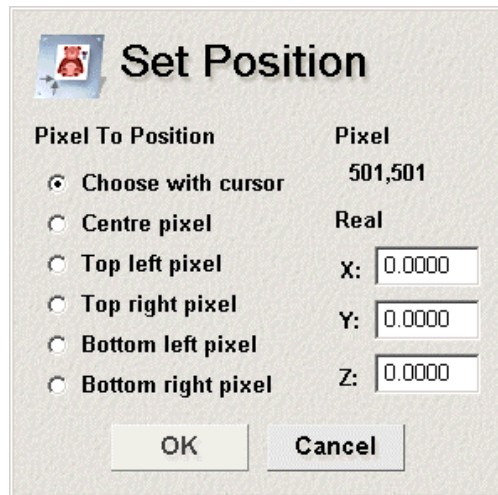

2. In the **Pixel To Position** area, click on one of the radio buttons  to select which pixel in the model you want to use as the origin:

- **Choose with cursor** – If you select this option, move the  cursor over the pixel in the model that you want to use and then click.

The co-ordinates of the pixel are displayed in the **Pixel** area.

- **Centre pixel** – Select this option to define the origin as the centre of the model.
- **Top left pixel** – Select this option to define the origin as the top left corner of the model.
- **Top right pixel** – Select this option to define the origin as the top right corner of the model.
- **Bottom left pixel** – Select this option to define the origin as the bottom left corner of the model.
- **Bottom right pixel** – Select this option to define the origin as the bottom right corner of the model.

If you want to define the exact location of the origin, define the appropriate X, Y and Z values in the boxes in the **Real** area.

3. Click on the **OK** button to close the **Set Position** dialog box and to define the new origin in the model.

## Clearing a Model

You can delete all bitmap data within a model and restore the background to the current Primary Colour.

To clear a model:

1. Make sure that the colour you want to use for the background of the model is selected as the Primary Colour. For details, see "Selecting the Primary and Secondary Colours" in the Working with Bitmaps chapter.
2. Click on the **Clear** button  in the **Model** toolbar to restore the background to the current Primary Colour.

You can also clear an open model in the following way:

1. From the Main menu bar, click on the **Model** option to display the **Model** menu, and then on the **Clear** option.

## Deskewing a Model

You can adjust a model to compensate for justification errors that may have occurred when scanning the bitmap images used within it. This operation is called deskewing.

To deskew a model:

1. From the Main menu bar, click on the **Model** option to display the **Model** menu, and then on the **Deskew** option to display the **Deskew Image** dialog box:

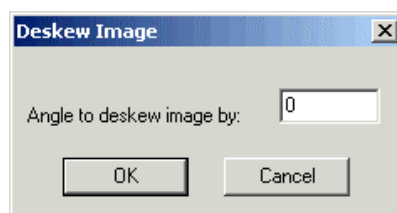

2. Define the deskewing angle in the **Angle to deskew image by** box.
3. Click on the **OK** button to deskew the model and close the **Deskew Image** dialog box.

## Creating a Greyscale Image from a Relief

A greyscale is an image in which the only colours are shades of grey. You can create a greyscale image from any relief in a model.



---

**Warning:** The greyscale image created from the existing relief replaces any bitmap images currently drawn in the **2D View** window. If you do not want to lose your bitmap artwork, use the **Greyscale View** button in the **2D View** toolbar instead.

---

It is recommended that you use this option to view a swept profile shape more clearly, particularly when you want to position vector text or 3D clipart relative to it. For details, see "Creating a Swept Profile Shape" in the Working with Reliefs chapter.

This option is particularly useful for identifying areas of a model to which you want to add texture, as the entire relief is painted in a single colour by default. For details, see "Adding Texture to a Relief" in the Working with Reliefs chapter.

To create a greyscale image from a relief, replacing any existing bitmap artwork in the **2D View** during the process:

1. Click on the **Greyscale From Relief** button  in the **Model** area of the **Assistant's** Home page.

You can also create a greyscale image from a relief in either of the following ways:

- Press the **F10** key on your keyboard.
- From the Main menu bar, click on the **Model** menu, and then click on the **Greyscale From Relief** option.



---

**Note:** If you want to restore the full colour image of a relief, click on the **Edit** option in the Main menu bar to display the **Edit** menu, and then on the **Undo Create Greyscale Image** option.

---

You can display a greyscale view of the existing relief without losing any of the bitmap artwork currently shown in the **2D View** window. To do so:

- Click on the **Greyscale View** button  in the **2D View** toolbar.



---

**Note:** You can set the default colours used in the **Greyscale View** using the **ArtCAM Options** page. For details, see "Managing ArtCAM Pro's Preferences" in the ArtCAM Pro Layout chapter.

---

## Adding a Border to a Model

You can create a border around an open model in the current Primary Colour. Any existing relief in the model is extended by the width of the border you define.

To create a border around a model:

1. Make sure that the colour in which you want to create the border is selected as the Primary Colour. For details, see "Selecting the Primary and Secondary Colours" in the Working with Bitmaps chapter.
2. Click on the **Add Border** button  in the **Model** area of the **Assistant's** Home page to display the **Add Border** dialog box:

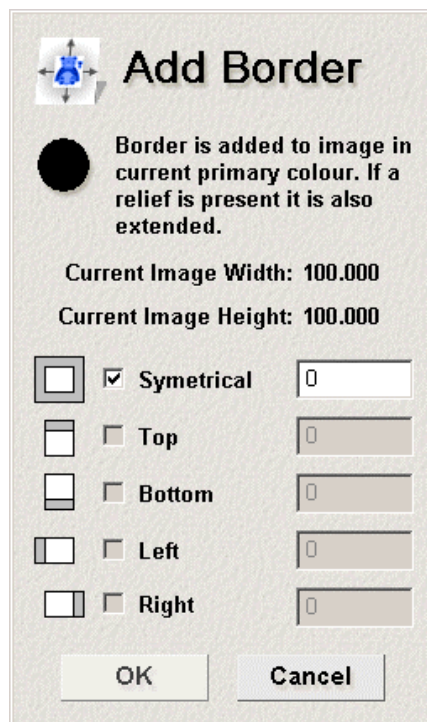

The current Primary Colour is shown, as is the width and height of the model. The **Symmetrical** border option is selected  by default.

3. If you want to create a symmetrical border, you can simultaneously define the width of all four sides in the adjacent box.

If you want to define the width of the border on each of the four sides independently:

- First, click to deselect the **Symmetrical** option .

- Next, click to select  the option for each of the sides (**Top**, **Bottom**, **Left**, **Right**) to which you want to add a border, and then define their widths in the adjacent boxes.

If a side option is not selected , it is greyed out.

4. Click on the **OK** button to close the **Add Border** dialog box and create the border around the model.

## Using a Spot Filter on a Bitmap Image

You can remove any isolated pixels from within a scanned bitmap image using a spot filter.

A spot filter performs better with black and white or greyscale images. It may be necessary to apply a spot filter several times on the same image to remove all unwanted pixels (spots) in the bitmap image.

To use a spot filter:

1. From the Main menu bar, click on the **Model** option to display the Model menu. Move over the **Spot Filter** option to display the filters available.
2. Click on the **Spot Filter** option that you want to apply to the bitmap image:
  - **Photo Image** – This option is the maximum filter that is most likely to remove unwanted spots in the image.



---

**Warning:** The **Photo Image** filter may also remove areas of the bitmap image that you want to keep.

---

- **General** – This option is the medium filter.
- **Line Drawing** – This option is the minimum filter, which removes only a few spots in the image. You may have to apply this filter several times before removing any unwanted spots.

The **Working** dialog box appears during the filtering process:



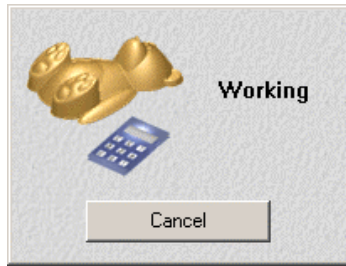

## Adjusting Light and Material Settings

You can alter the appearance of a model in the **3D View** window by:

- Using up to four different lights at once to illuminate selected areas of the relief.
- Changing the colour of the relief to match that of the actual block of material used in the manufacturing process.
- Changing the background colour or filling it with a bitmap image.
- Projecting an image or reflection map onto the relief.

This allows you to create an authentic impression of the machined model.

### *Light and Shading Settings*

You can illuminate selected areas of the relief shown in the **3D View** window using up to four types of light in a number of combinations.

To change the light or shading settings:

1. Click on the **Lights and Material** button  in the **Model** area of the **Assistant's** Home page to display the **Lights and Material** page.



---

**Note:** You can also display the **Lights and Material** page if you click on the **Model** menu in the Main menu bar, and then on the **Lights and Material Setup** option.

---

2. If you want to load a light (\*.lgt) or shading (\*.shd) setting file that you have previously saved, click on the **Load** button to open the **Load Lights and Material Settings** dialog box:

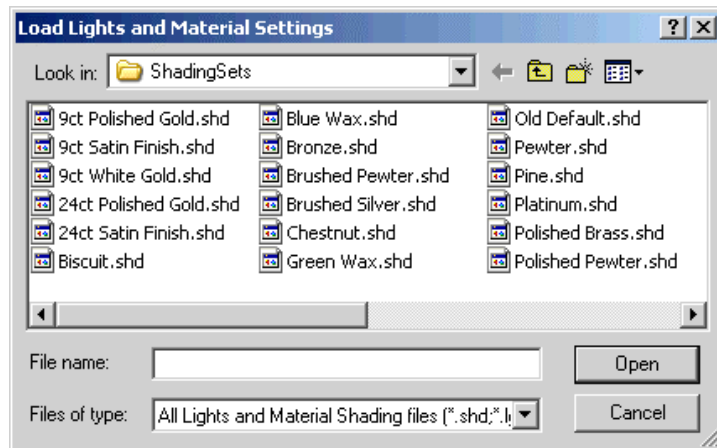



Click on the **Look in** list box and select the directory where the file that you want to load is stored, and then click to select the setting file that you want to load. The file name appears in the **File name** box

Click on the **Open** button to load the settings into the **Lights and Material** page.

3. If you want to use any of the preset shading settings in ArtCAM Pro, click on the list box in the **Shading Setup** area, and then on the shading setting that you want to use.
4. To adjust the amount of background lighting, click and drag on the **Ambient** slider.
5. In the **Lights** area, there are four options that you can use to expose light to the relief. To expose light to a relief, click on the **Enabled** option beside the light options that you want to select .
6. To edit the settings for any of the lights you have enabled, click on the  arrow to display them.

If you want to change the type of light, click on the **Type** list box, and then on the light option that you want to use:

- **Distant** – This option allows you to add the effect of a light at a distance from the relief. The  icon appears if this type of light is selected.
- **Point** – This option allows you to add the effect of a light bulb held over the relief. The  icon appears if this type of light is selected.
- **Spot** – This option allows you to add the effect of a spot light held over the relief. The  icon appears if this type of light is selected.

Next, set the colour of the light:

- First, click on the **Colour Palette** button  or the colour shown beside it to display the **Color** dialog box:

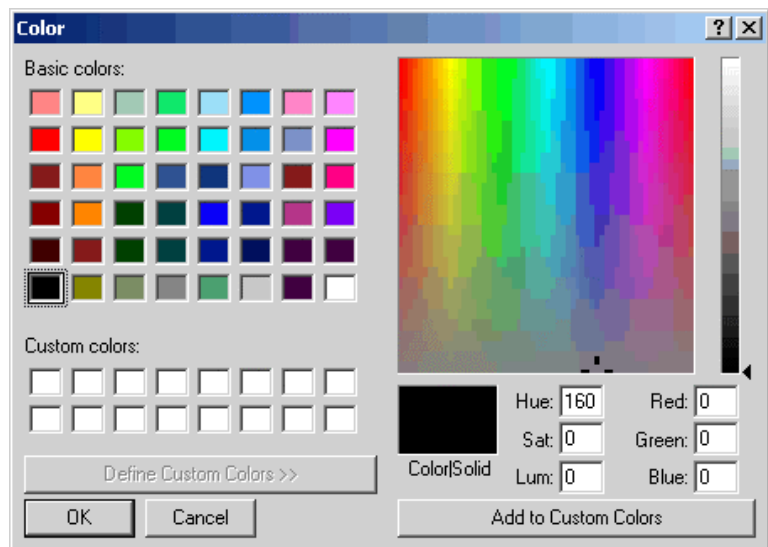

- Next, select the colour that you want to use for the light. For details on how to select Basic and Custom colours, see "Assigning a Colour to a Layer" on page 111.
- Finally, click on the **OK** button to close the **Color** dialog box.

You can now adjust the contrast of the light by clicking and dragging on the **Intensity** slider.

If you have selected a **Spot Light**, you can adjust its focus by clicking and dragging on the **Edge** slider. You can also adjust its scope by typing a value in the **Width** box.

If you have selected a **Point Light** or a **Spot Light**, you can adjust its position relative to the relief:

- Click on the bulb icon  on the **Lights and Material** page and drag it into position over the relief in the **3D View** window.

The value displayed in the first box is shown as a percentage of the width (X) of the model.

The value displayed in the second box is shown as a percentage of the height (Y) of the model.

- The value displayed in the third box is shown as a percentage of half the height of the longest side in the model. This value is then used for the Z height of the light.

If you have selected a **Distant Light** or a **Spot Light**, you can set the direction of the light:

- To align the direction of the light to one of seventeen points on the sphere, click on the **Use Snap points on sphere** option to select it .

Click and drag on the sphere and release the mouse button when the  $\oplus$  cursor has snapped to the point that you want to use as the light direction.

- If you want to align the direction of the light with your field of vision when focused directly at your computer monitor, click on the **Fix light along viewing direction** option to select it .





---

**Note:** This option is only available if you have enabled a **Distant Light**.

---

To hide the settings for a light you have enabled, click on the arrow.

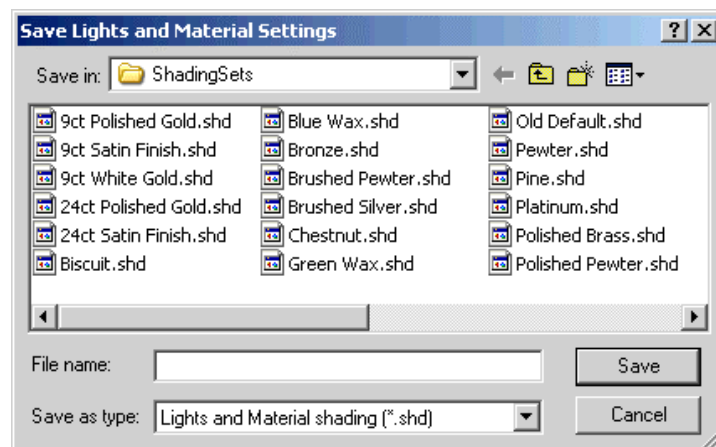
7. Click on the **Apply** button to apply the changes you have made to the light and/or shading settings.
8. You can now save or reset your light and shading settings:
  - If you want to save these light and shading settings, click on the **Save** button to display the **Save Lights and Material Settings** dialog box:



Click on the **Save in** list box and select the directory where you want to save the file. Type a name for the file in the **File Name** box, and then click on the **Save** button.

- If you are not happy with these light and shading settings, you can either continue to adjust them or click on the **Reset** button to restore the default settings.
9. If you want to set your light and shading settings as default, click on the **Set As Default** button.
  10. Click on the **Done** button to close the **Lights and Material** page and return to the **Assistant's Home** page.

## ***Material and Background Settings***

You can change the colour used to shade the relief in the **3D View** window, the brightness of the lit areas on the relief surface, and the reflectivity of the relief surface. You can also select a background colour or image for the **3D View** window, and project a reflection map onto the relief surface.

You can use the sphere in the **Material** area of the page to preview the effects that the settings you create have on the relief shown in the **3D View** window:



To change the material settings:

1. Click on the **Lights and Material** button  in the **Model** area of the **Assistant's Home** page to display the **Lights and Material** page.
2. If you want to load a material shading (\*.mtl) setting file that you have previously saved, click on the **Load** button to open the **Load Lights and Material Settings** dialog box:

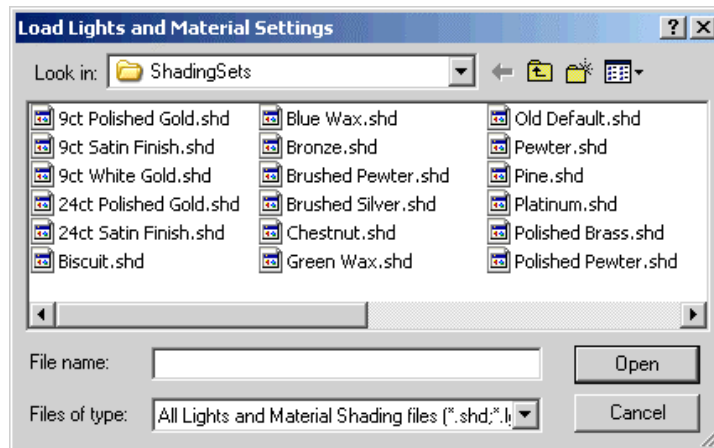

Click on the **Look in** list box and select the directory where the file that you want to load is stored, and then click on the setting file that you want to load to select it. The file name appears in the **File name** box

Click on the **Open** button to load the settings into the **Lights and Material** page.

3. To change the colour of the material shown in the **3D View** window, click on the list box in the **Colour** area, and then on the option that you want to use:
  - **Selected Colour** - This option allows you to select the colour of the relief using the **Color** dialog box. For further information, see "Assigning a Colour to a Layer" on page 111. You can then edit the chosen colour using the sliders in the **Colour** area.
  - **2D View** - This option allows you to project the bitmap colours or image, as shown in the **2D View** window, onto the relief.

If you want to use any of ArtCAM Pro's preset materials, click on the list box in the **Colour** area, and then on the material that you want to use. When using any of these preset settings:

- If you want to tile the material across the relief, click to select the **Tile** option and then define its size using the **Size X** and **Size Y** boxes.
- If you want to replace areas of the relief under the current Primary Colour with the selected material, click to select the **Only Show Image Under Primary Colour** option.



---

**Note:** If you want to use your own material, copy the TIF image file (\*.tif) representing the material to the ArtCAM Pro\Rendering\Materials folder and then restart ArtCAM Pro. Your image will then be listed in the **Colour** list box when the **Lights and Material** page is next displayed.

---

4. To adjust the reflectivity of the material surface, click and drag on the **Shininess** slider.
5. To adjust the brightness of the lit areas in the model, click and drag on the **Highlight Intensity** slider.
6. If you want to project a reflection map onto the relief surface, click on the list box in the **Reflection Map** area, and then on the reflection map that you want to use.
7. You can now fill the background of the **3D View** window with an image or a colour. To fill the background with a colour:
  - In the **Background** area, click on the list box and then on the **Selected Colour** option. This is the default option when the **Lights and Material** page is displayed.
  - Next, click on the **Colour Palette** button  to display the **Color** dialog box.
  - Select the colour that you want to use as the background. For details on how to select Basic and Custom colours, see "Assigning a Colour to a Layer" on page 111.
  - Finally, click on the **OK** button to close the **Color** dialog box.

To fill the background with a bitmap image:

- In the **Background** area, click on the list box and then on the image that you want to use.



---

**Note:** If you want to use your own bitmap image as a background in the **3D View** window, copy the bitmap file (\*.bmp) to the ArtCAM Pro\Backgrounds folder and then restart ArtCAM Pro. Your image will then be listed in the **Background** list box when the **Lights and Material** page is next displayed.

---

8. Click on the **Apply** button to apply the material settings that you have chosen.
9. You can now save or reset your material settings:
  - If you want to save these material settings, click on the **Save** button to display the **Save Lights and Material Settings** dialog box:

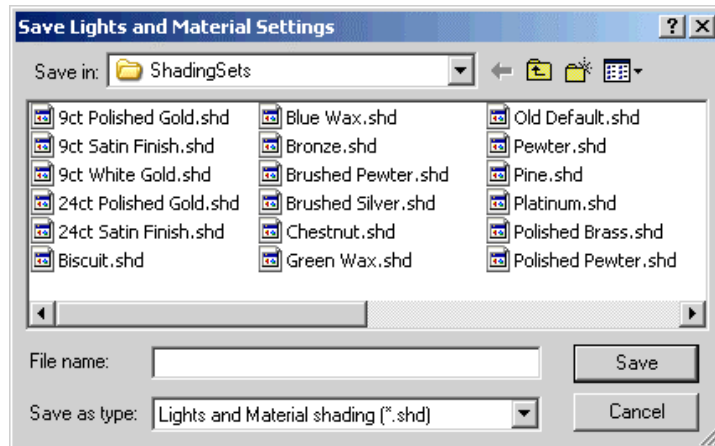

- Click on the **Save in** list box and select the directory where you want to save the file. Type a name for the file in the **File Name** box, and then click on the **Save** button.
  - If you are not happy with these light and shading settings, you can either continue to adjust them or click on the **Reset** button to restore the default settings.
10. If you want to set your material settings as default, click on the **Set As Default** button.
  11. Click on the **Done** button to close the **Lights and Material** page and return to the **Assistant's Home** page.

## Using the Selection Rectangle



You can use a selection rectangle to define an area in a model, which can then be used to:

- Set the dimensions of the model. For details, see "Editing the Model Dimensions" on page 62.
- Set the asymmetrical dimensions of the model. For details, see "Editing Asymmetrical Dimensions in a Model" on page 63.



- Crop the model. For details, see "Cropping a Model" on page 79.
- Copy and paste an area of a bitmap image. For details, see "Copying and Pasting Bitmap Areas" in the Working with Bitmaps chapter.
- Create a dome shape. For details, see "Creating a Dome" in the Working with Reliefs chapter.

To create a selection rectangle:

1. Click on the **Selection Rectangle** button  in the **File** toolbar.
2. Move the  cursor over a corner of the area in the model that you want to select, then click and drag diagonally.

The selection rectangle appears in the **2D view** window as follows:





If you want to move the selection rectangle to another area in the model:

- Move the cursor inside of the selection rectangle, then click and drag it into position.

If you want to edit the size of the selection rectangle:

- Move the cursor over a corner or side of the selection rectangle, then click and drag to set its size.

## Cropping a Model

1. Click on the **Selection Rectangle** button  in the **File** toolbar.
2. Move the  cursor over a corner of the area in the model that you want to select, then click and drag diagonally.

The selection rectangle appears in the **2D view** window as follows:



If you want to move the selection rectangle to another area in the model:

- Move the cursor inside of the selection rectangle, then click and drag it into position.

If you want to edit the size of the selection rectangle:

- Move the cursor over a corner or side of the selection rectangle, then click and drag into position.

3. From the Main toolbar, click on the **Edit** menu, followed by the **Crop** option.

## Using the ArtCAM Pro Notepad

You can add comments concerning a model to the ArtCAM Pro notepad.

To use the ArtCAM Pro notepad:

1. Click on the **Display/Hide Notes** button  in the **File** toolbar to display the **ArtCAM Notes** window:



2. Click on the **ArtCAM Notes** window and then type the comments that you want to add about the model using your keyboard.



---

**Tip:** If you type **..** and then press the **Enter** key on your keyboard before typing your comments, the **ArtCAM Notes** window is displayed when you open the saved model again.

---

3. Click on the **Display/Hide Notes** button  to close the **ArtCAM Notes** window.

When the open model is saved, any comments that have been added to the **ArtCAM Notes** window are also saved.

If you do not save the model, any comments that you have added are deleted from the **ArtCAM Notes** window.

## Importing Vector Artwork

In ArtCAM Pro, you can import vector artwork saved as files of type **\*.dxf**, **\*.eps**, **\*.dwg**, **\*.ai**, **\*.wmf** or **\*.pic** into a model.

When importing Drawing Interchange (**\*.dxf**) or AutoCAD Drawing (**\*.dwg**) files, you can position its vector artwork in the centre of the ArtCAM model, define the units of measurement used, instruct ArtCAM Pro to identify loops within tolerance and rejoin all coincident points (nodes) within tolerance. ArtCAM Pro also reads all layer information saved within these files. For further information, see "Working with Layers" on page 110.

When importing Encapsulated PostScript (\*.eps, \*.ai) files with an origin outside of an ArtCAM model, you can position its vector artwork in the centre of the ArtCAM model or according to the origin saved within the file.

Windows Meta (\*.wmf) and Lotus or PC Paint PIC (\*.pic) files import into ArtCAM Pro directly.

To import vector artwork:

1. Click on the **Import Vector Data** button  in the **File** area of the **Assistant's** Home page to display the **Vector Import** dialog box:

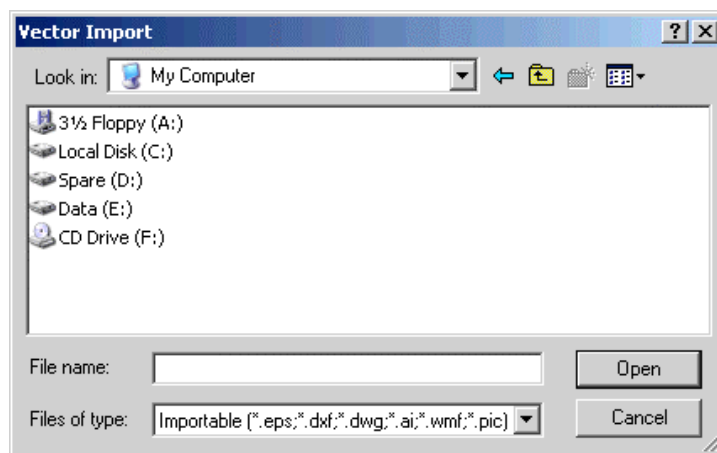

---

**Note:** You can also open the **Vector Data** dialog box by clicking on **File > Import > Vector Data** from the Main menu bar.

---

2. Click on the **Look In** list box and find the file that you want to import.
3. Once you have found the file, click on its file name.
4. Click on the **OK** button to import the vector artwork into the currently selected layer.

If you are importing vector artwork saved as a \*.dxf file, the **Imported File** dialog box is displayed:

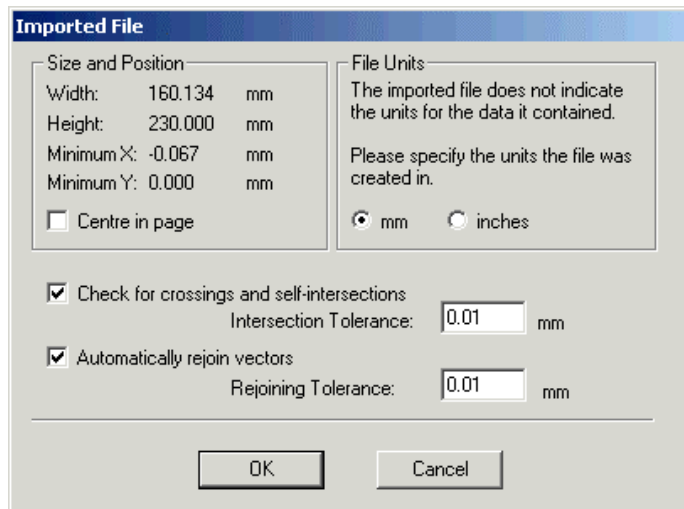

Make sure the settings for the imported vector data are correct:

- If you want to position the imported vector data in the centre of the model, click to select the **Centre In Page** option .
- In the **File Units** area, make sure that the units for the imported data are the same as those used for the ArtCAM model by clicking on the correct radio button .
- If you want to identify all self-intersecting spans in the vector data within tolerance, make sure that the **Check for crossings and self-intersections** option is selected . Define the tolerance in the **Intersection Tolerance** box.

Self-intersecting spans are shown in red when selected, with white circular shapes marking the positions where the spans overlap. For details, see "Selecting Vectors" in the Working with Vectors chapter.

- If you want to rejoin any spans in the vector data that have been 'exploded' within tolerance, make sure that the **Automatically rejoin vectors** option is selected . Define the tolerance in the **Rejoining Tolerance** box.

If you are importing vector artwork saved as an Encapsulated PostScript file (\*.eps or \*.ai) with its origin is outside of the current ArtCAM model, the **Choose Location of Data** dialog box is displayed:

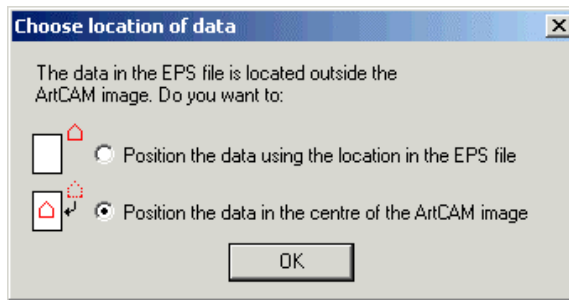

Click on either of the radio buttons  to select where you want to position the imported data in the ArtCAM model, and then click on the **OK** button to import the vector artwork.



The imported vector object is selected by default. It is magenta and surrounded by a bounding box. When deselected, the vector object appears in the colour assigned to the selected layer. For further information, see "Selecting Vectors" in the Working with Vectors chapter.

## ***Using a Vector Library***

You can now use the **Vector Library** tool to manage vector data saved as **\*.eps**, **\*.dxf**, **\*.dwg**, **\*.ai**, **\*.wmf** and **\*.pic** files that you want to import into an ArtCAM model. ArtCAM Pro recalls the position in which the vector object was saved.



A vector library is made up of at least one folder that contains one or more **\*.eps**, **\*.dxf**, **\*.dwg**, **\*.ai**, **\*.wmf** and **\*.pic** files.

ArtCAM Pro creates an area on the **Vector Library** page for each of the folders within a library that contain **\*.eps**, **\*.dxf**, **\*.dwg**, **\*.ai**, **\*.wmf** and **\*.pic** files. If an **\*.eps**, **\*.dxf**, **\*.dwg**, **\*.ai**, **\*.wmf** or **\*.pic** file within a library shares the same name as a **\*.jpg** or **\*.gif** file also within the same library, ArtCAM Pro creates an icon next to its filename. If there are no **\*.eps**, **\*.dxf**, **\*.dwg**, **\*.ai**, **\*.wmf** or **\*.pic** files in a selected directory, a message is displayed on the page indicating that no library has been found.

You can click on the  arrow on the page to hide the list of files within a library's folder, and on the  arrow to reveal the list.

To select a folder as a vector library:

1. Click on the **Import From a Vector Library** button  in the **Vector Editing** area of the **Assistant's Home** page to display the **Vector Library** page.

2. If you cannot see the vector library settings, click on the **Choose Library** arrow  to display them. Any existing vector libraries are listed in the **Libraries** box.
3. Click on the **New** button to display the **Browse For Folder** dialog box.
4. Click to select the directory in which you want to store your vector artwork files, or in which they are already kept. It is highlighted in blue.
5. Click on the **OK** button to select the directory, and then close the **Browse For Folder** dialog box. The directory is now defined as an ArtCAM vector library.
6. Click on the  icon to return to the **Assistant's** Home page.







---

**Note:** You can also press the **Esc** key on your keyboard or the  icon at the top of the page to return to the **Assistant's** Home page.

---

To import a file from a vector library:

1. Click on the **Import From a Vector Library** button  in the **Vector Editing** area to display the **Vector Library** page.
2. If you cannot see the vector library settings, click on the **Choose Library** arrow  to display them. All existing vector libraries are listed in the **Libraries** list box.
3. Move the cursor over the filename in the list containing the vector artwork that you want to import, and then click. The vector artwork appears in the **2D View** window.
4. Click on the  icon to return to the **Assistant's** Home page.







---

**Note:** You can also press the **Esc** key on your keyboard or the  icon at the top of the page to return to the **Assistant's** Home page.

---

To refresh the list of files identified within a library:

1. Click on the **Import From a Vector Library** button  in the **Vector Editing** area to display the **Vector Library** page.

2. If you cannot see the vector library settings, click on the **Choose Library** arrow  to display them. All existing vector libraries are listed in the **Libraries** box.
3. Click on the **Libraries** list box, and then on the library for which you want to update the listing.
4. In the **Options** area, click on the **Rescan** button to refresh the list of folders and files within the current library
5. Click on the  icon to return to the **Assistant's** Home page.







---

**Note:** You can also press the **Esc** key on your keyboard or the  icon at the top of the page to return to the **Assistant's** Home page.

---

To remove a library:

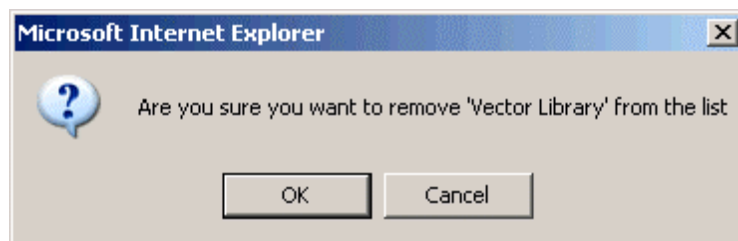
1. Click on the **Import From a Vector Library** button  in the **Vector Editing** area to display the **Vector Library** page.
2. If you cannot see the vector library settings, click on the **Choose Library** arrow  to display them. All existing vector libraries are listed in the **Libraries** box.
3. Click on the **Libraries** list box, and then on the library you want to remove.
4. In the **Options** area, click on the **Remove** button to remove the selected library.
5. A message box appears asking you to confirm your decision to remove the library:



Click on the **OK** button to close the message box and remove the library.

6. Click on the  icon to return to the **Assistant's** Home page.





---

**Note:** You can also press the **Esc** key on your keyboard or the **X** icon at the top of the page to return to the **Assistant's** Home page.

---

## Exporting Vector Artwork

You can export vector objects as data. This data can then be used in other drawing packages supporting **\*.eps**, **\*.dxf** and **\*.pic** file formats.

To export vector objects as data:

1. Select the vector object(s) that you want to export. For details, see "Selecting Vectors" in the Working with Vectors chapter.
2. From the Main menu bar, click on the **File** menu, followed by the **Export...** option to display the **Vector Export** dialog box:

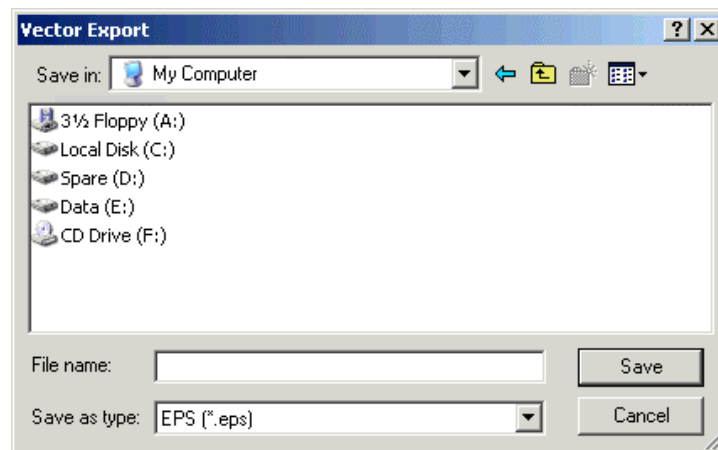

3. Click on the **Save In** list box and select the directory you want to save the vector object in.
4. Type the file name you want to use for the vector object(s) in the **File name** box.
5. Click on the **Save as type** list box, and then click on the file type you want to use.
6. Click on the **Save** button.

## Importing a 3D Model File

You can import triangle models saved as 3D Assembly (**\*.3da**), 3D Studio (**\*.3ds**), Drawing Interchange Format (**\*.dxf**) and STL (**\*.stl**) files into an ArtCAM model:

1. From the Main menu bar, click on the **File > Import > 3D Model** option to display the **Import 3D Model** dialog box:

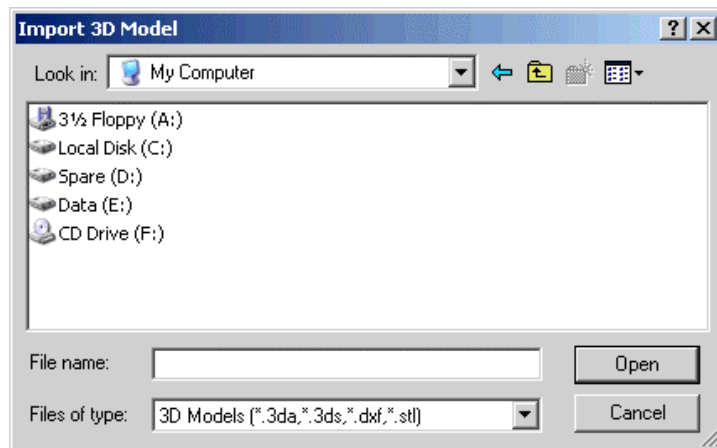

2. Click on the **Look In** list box and find the file that you want to import.
3. Once you have found the file, click to select the file listed in the main window of the **Import 3D Model** dialog box. Its name appears in the **File Name** box.
4. Click on the **Open** button to import the file into the model and display the **Paste 3D Model** dialog box:

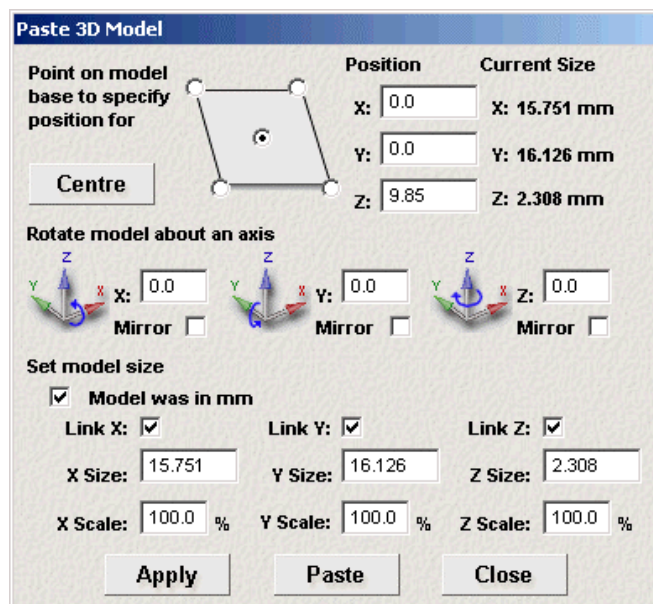





The current size of the model is shown and the original coordinate system used when the triangle model was constructed is kept.

5. You can now use the **Paste 3D Model** dialog box to set the position, size and origin of the triangle model before it is pasted into the relief within the ArtCAM model.

## Using the Paste 3D Model Dialog Box

The **Paste 3D Model** dialog box allows you set the position, size and origin of an imported three-dimensional model before it is pasted into the relief within an ArtCAM model.

To define how the triangle model is pasted into the relief:

1. Set the position of the triangle model within the ArtCAM model:
  - To position the triangle model in the centre of the ArtCAM model, click on the **Centre** button.
  - To position the triangle model in the centre or one of the four corners in the ArtCAM model, click on the appropriate **Point on base to specify position for** radio button  on the model diagram.
  - To position the triangle model in a specific location within the ArtCAM model, define the co-ordinates in the **X**, **Y** and **Z** boxes.
2. To rotate the triangle model on any of the three axes:
  - In the **Rotate model about an axis area**, define the angle of rotation in the **X**, **Y** and/or **Z** box.
  - To mirror the model in any of the three axes, make sure that the **Mirror** option below the **X**, **Y** and/or **Z** box is selected .
3. If you are working in inches, the **Model was in inches** option is selected  by default. If the triangle model appears too large, either click to deselect the option and scale the 3D model between inches and mm, or proceed to the next step to resize or scale the triangle model.  
  
If you are working in millimetres, the **Model was in mm** option is selected  by default. If the triangle model appears too small, either click to deselect the option and scale the triangle model between mm and inches, or proceed to the next step to resize or scale the triangle model.
4. Set the size of the triangle model:
  - To resize or scale the triangle model in a specific axis, click to deselect the **Link** options for the axes that you do not want to adjust . For example, if you only want to resize the model in the X-axis, click to deselect the **Link Y** and **Link Z** options.

- In the **Size** box, define the new size for the axis that you want to adjust.
- In the **Scale** box, define the new scale for the axis that you want to adjust.

5. Click on the **Apply** button.



---

**Tip:** Click on the **Apply** button whenever you type a new value in the **Paste 3D Model** dialog box so you can see how your model is changing.

---

6. Click on the **Paste** button to paste the triangle model into the relief within the ArtCAM model using the **Merge Highest** option. For details, see "Merge Highest" in the Working with Reliefs chapter.
7. Click on the **Close** button to close the **Paste 3D Model** dialog box and paste the triangle model into the relief within the ArtCAM model.

## Example

In the following example, you can see how the **Paste 3D Model** dialog box is used to set the size and position of an imported triangle model, and then paste it into the relief within an ArtCAM model.

1. Click on the **Create New Model** icon  on the **Getting Started** page to display the **Size For New Model** dialog box:

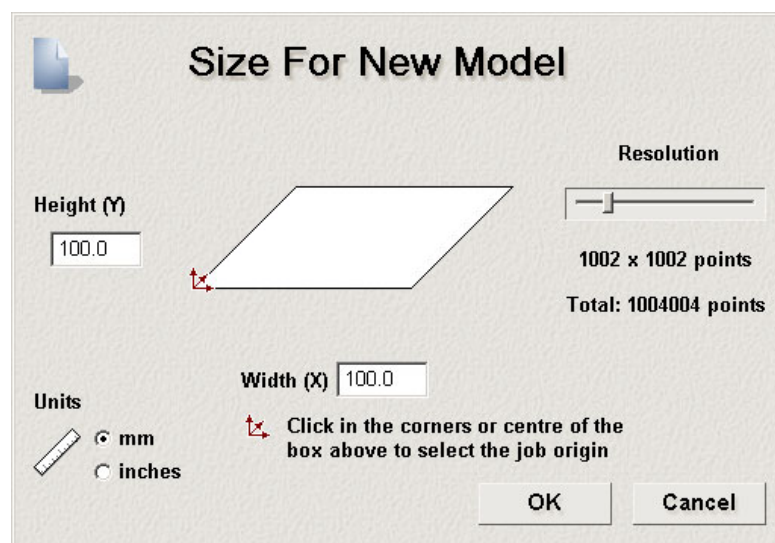

2. Click on the **mm** radio button  in the **Units** area to set the units of measurement as millimetres.

3. Type *100* in the **Height (Y)** and **Width (X)** boxes.
4. Click and drag on the **Resolution** slider and set it to *1004004* points.
5. Click on the **OK** button to close the **Size For New Model** dialog box and create the ArtCAM model.
6. From the Main menu bar, click on the **File** option to display the **File** menu, then on the **Import > 3D Model** option to display the **Import 3D Model** dialog box:

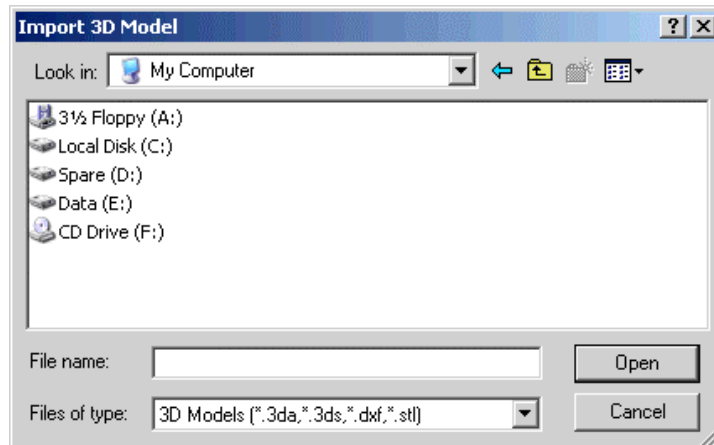

7. Click to select the **cow.dxf** file in the ArtCAM Pro 8.0\Examples\3d models directory, and then click on the **Open** button to import the triangle model into your ArtCAM model.

The cow triangle model appears on the origin of the ArtCAM model in the **3D View** window. The **Paste 3D Model** dialog box also appears:

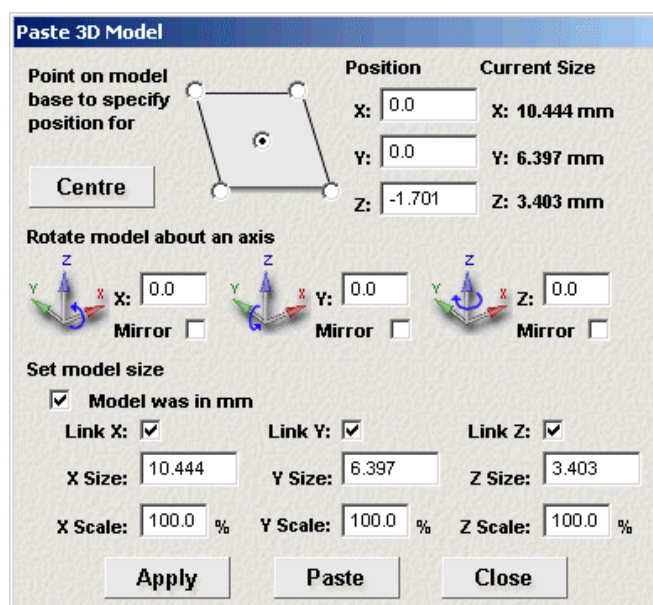

8. You are now ready to set the position of the cow triangle model within the ArtCAM model. In the **Position** area of the dialog box:
  - First, type *50* in the **X** box.
  - Next, type *50* in the **Y** box.
  - Finally, type *-14.499* in the **Z** box.
9. You are now ready to resize the cow triangle model. In the **Set Model Size** area, type *89.999* in the **X Size** box.
10. Click on the **Apply** button to resize and position the cow triangle model.
11. Click on the **Paste** button to combine the cow triangle model with the relief in the ArtCAM model. The relief should appear in the **3D View** window something like the image shown below:

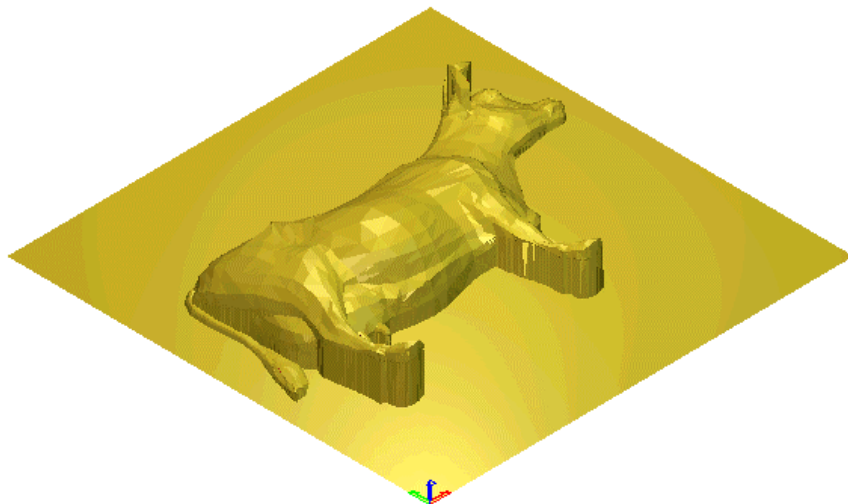

## Importing a 3D Model File for Unwrapping

You can import wrapped triangle models saved as 3D Assembly (\*.3da), 3D Studio (\*.3ds), Drawing Interchange Format (\*.dxf) and STL (\*.stl) files into an ArtCAM model.

The imported model can then be unwrapped along a cylindrical axis into a flat relief within an ArtCAM model. This command is intended for unwrapping ring designs created in other CAD systems into flat reliefs for machining within ArtCAM Pro.

To import a triangle model that you want to unwrap:

1. From the Main menu bar, click on the **File > Import > 3D Model For Unwrapping** option to display the **Import 3D Model** dialog box.
2. Click on the **Look In** list box and find the file that you want to import.
3. Once you have found the file, click to select the file listed in the main window of the **Import 3D Model** dialog box.
4. Click on the **Open** button to import the file into the open ArtCAM model.

If you select a file that does not contain normals, the following message box appears:

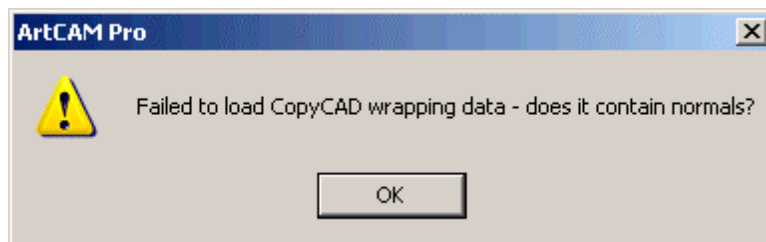

Click on the **OK** button to close the message box.

If the file contains normals, the **3D Model Unwrapping** page is displayed in the **Assistant** window and the **Paste 3D Model** dialog box appears:

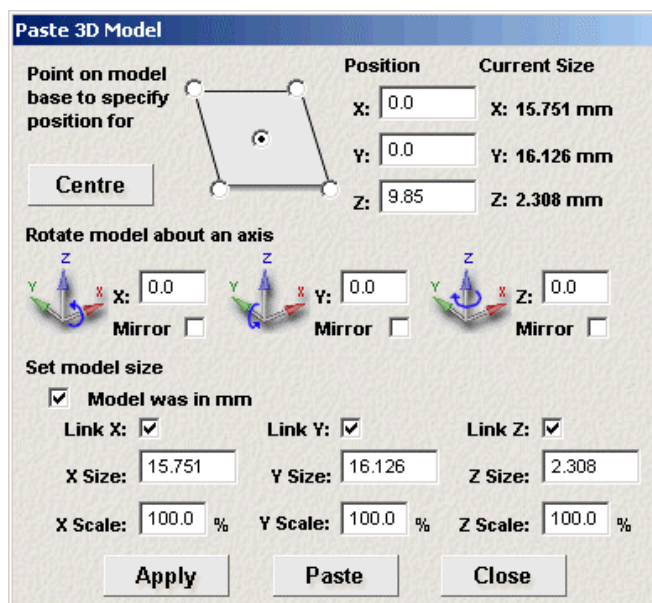

---

**Note:** Normals show the direction from which the points in the 3D model were taken and are perpendicular to the model surface.

---

The current size of the model is shown and the original coordinate system used when the triangle model was constructed is kept.

5. You can now use the **Paste 3D Model** dialog box and/or the **3D Model Unwrapping** page to set the position, size and origin of the unwrapped model and exactly how it will be unwrapped:
  - For details on using the **Paste 3D Model** dialog box, see "Using the Paste 3D Model Dialog Box" on page 89.
  - For details on using the **3D Model Unwrapping** page, see "Using the 3D Model Unwrapping page" on page 94.

### ***Using the 3D Model Unwrapping page***

The **3D Model Unwrapping** page allows you to unwrap an imported triangle model along a cylindrical axis into a flat relief within an ArtCAM model.

To unwrap a triangle model along a cylindrical axis:

1. In the **3D Model Origin** area, define the position of the triangle model's origin within the ArtCAM model using the the **X**, **Y** and **Z** boxes.
2. In the **Rotate Model** area, use the  and  buttons to rotate the triangle model along any of the three axes in the ArtCAM Pro model in 90° increments.
3. In the **Unwrapping Cylinder** area:
  - In the **Diameter** box, define the diameter of the cylindrical axis along which the triangle model is unwrapped.
  - Click on one of the **Axes** radio buttons  to select the axis along which the centreline in the triangle model is aligned.
  - In the **Border Width** box, define the width of the border which is added above and below the triangle model.

If you want to add a border later or using another method, see "Adding a Border to a Model" on page 69 for details.



4. Click on the **Create New Model** button.
5. Click on the **Close** button to return to the **Assistant's** Home page.

## Importing CopyCAD Relief Data

You can import a wrapped relief map with normals saved as American Standard Code for Information Interchange (\*.asc) or CopyCAD Binary (\*.ccb) format files into a model. The imported relief data is attached to the base of a relief within the ArtCAM model.



---

**Note:** Normals show the direction from which the points in the 3D model were taken and are perpendicular to the model surface. The size of the wrapped relief map with normals must match that of the relief within the ArtCAM model.

---

To import relief data:

1. From the Main menu bar, click on the **File > Import > Load CopyCAD Wrapping Data** option to display the **Load CopyCAD Wrapped Relief Map** dialog box:

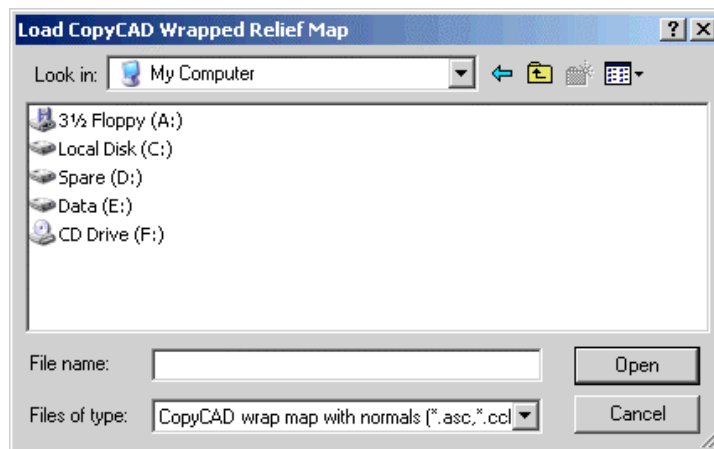

2. Click on the **Look In** list box and find the file that you want to import.
3. Once you have found the file, click on the file name listed in the main window of the **Load CopyCAD Wrapped Relief Map** dialog box.
4. Click on the **Open** button to import the file into the ArtCAM model.

If you select a file that does not contain normals, the following message box appears:

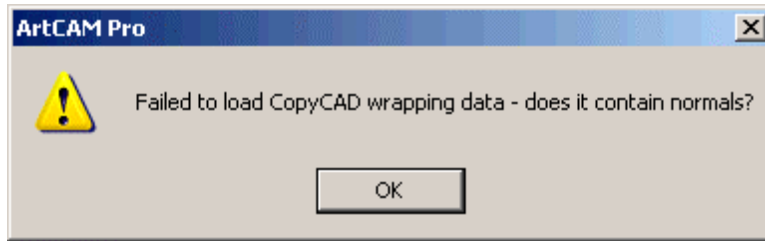

Click on the **OK** button to close the message box.

If the size of the imported wrapped relief map with normals does not match that of the relief within the ArtCAM model, the following message box appears:

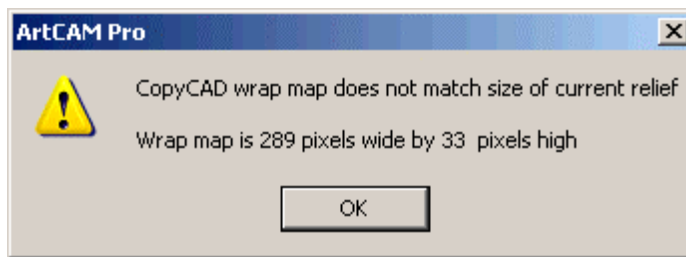

Click on the **OK** button to close the message box.

## Multiplate Engraving Tool

ArtCAM Pro allows you to create sheets of badges or name-plates, each with its own unique details, using only vector artwork to define the shape and layout, a text file (\*.txt or \*.csv) containing the data you want to feature on the plates, and vector text to define how and where this data is used.

A multiplate is made up of one or more sheets of vector artwork representing individual plates. The total number of sheets depends on the total number of plates created. The total number of plates able to fit onto a sheet depends on the size of the vector artwork used for the plate layout, the defined gaps between each plate along the X and Y-axes, and the defined boundary along the X and Y-axes.

Each plate is made up of variables. A block of vector text within curly braces defines each of the variables on a plate. When creating the multiplate, ArtCAM Pro replaces the vector text within double curly braces with data from an imported text file. The data assumes the same style of font, and any formatting, of the original block of vector text. What of the data within the imported text file will be created as vector text depends on what field headings within the text file are assigned to the variables.

To create a multiplate:

1. Create the vector artwork representing the overall shape of the plate to which you want to add data. For further details, see the "Working with Vectors" chapter.

For example, a rectangle with filleted corners might be used:



2. Use the **Text Tool** to type the names of the variables that you want to use on each of the plates in vector text. These must be enclosed in double curly braces. For further details, see "Creating Vector Text" in the Working with Vectors chapter.

In our example, the template vector artwork for the plate layout now appears as follows:



3. Create the toolpath that you want to use to machine the plates that you are creating. For details, see "Toolpaths" in the Machining Models chapter.
4. From the **2D View** window, select all of the vector artwork representing the template for the plate layout, along with the preview of the toolpath you have calculated. For details, see "Selecting Vectors" in the Working with Vectors chapter and "Selecting Toolpaths" in the Machining Models chapter.
5. Click on the **Create Multiple Plates...** button  in the **File** area of the **Assistant's** Home page to display the **Multi-plate Tool** page.

If you click on the button without first selecting the vector artwork representing the template for the plate layout, the following message box appears:

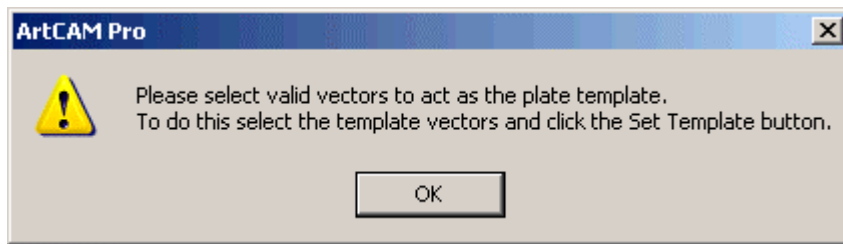

Click on the **OK** button to close the message box, and then select the vector artwork.

6. Click on the **Set Template** button to set the selected vector artwork as the template for the plate layout.
7. In the **Import Text File Data** area, click on the **Load Data** button to display the **Load Data** dialog box:

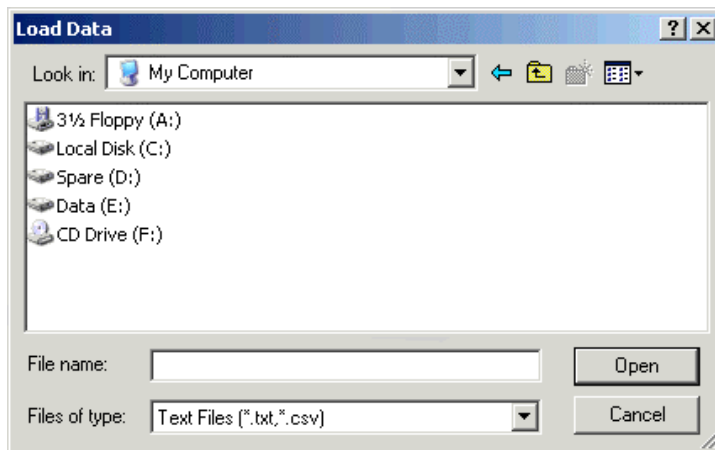

---

**Note:** You can open data saved as a **\*.txt** or **\*.csv** file only.

---

8. Click on the **Look in** list box and select the directory in which the text file that you want to open is stored.
9. Once you have found the text file, click on its file name. Its name appears in the **File Name** area.
10. Click on the **Open** button to display the **Text File Import** dialog box.

In our example, the data within a **.txt** file is shown in the **Text File Import** dialog box as follows:

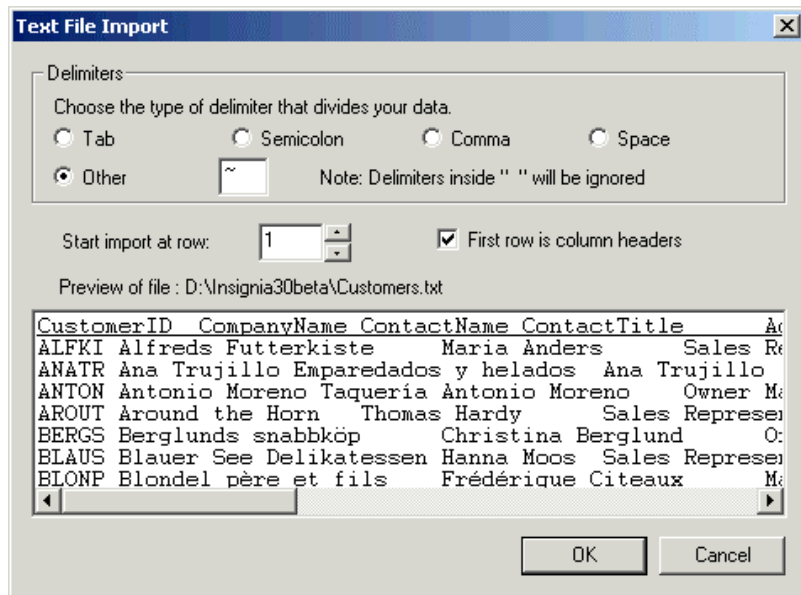

11. You can see a preview of the data within the imported text file in the main window of the dialog box. You can control the appearance of this data and what of it will be used in the Multiplate tool:

- In the **Delimiters** area, click to select the option for the delimiter that has been used to divide the data in the imported text file.







---

**Note:** All delimiters contained within quotation marks, " ", are ignored.

---

If a delimiter has been used other than any of those listed, you must type the delimiter in the box, and then click to select the **Other** option .

- If you want to set the first row of text as column headers, click to select the **First row is column headers** option .
- Define the row from which you want to import data into the Multiplate tool. You can either type the number in the box, or use the  and  arrows to set the row number.

In our example, the data within the **Text File Import** dialog box now appears as follows:

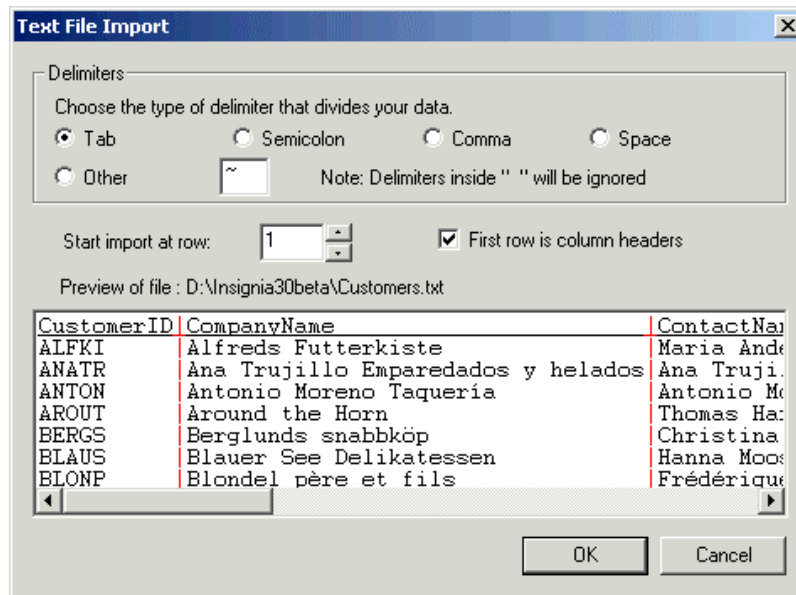

12. Click on the **OK** button to load the data into the Multiplate tool.
13. In the **Sheet Layout** area, use the settings to define the material dimensions and the number of plates you want to create:
  - Define the width of the material in the **Total Width** box.
  - Define the height of the material in the **Total Height** box.
  - Define the number of plates you want to create in the **Number of Plates** box.

The total number of sheets is displayed on the page. The number of sheets created depends on the size of the material and the number of plates.

14. In the **Plate Layout** area, use the settings to define the overall appearance of the plates created in a sheet:
  - Define the number of the first plate in the sheet in the **First Plate Position** box.
  - Define the distance along the x-axis between each plate in the **Plate Gap in X** box.
  - Define the distance along the y-axis between each plate in the **Plate Gap in Y** box.
  - Define the width of the boundary along the left and right edges of each sheet in the **X Boundary** box.

- Define the width of the boundary along the top and bottom edges of each sheet in the **Y Boundary** box.

15. Click on the **Next** icon  to display more settings.





---

**Note:** You can also use the **Close** icon  to return to the **Assistant's** Home page.

---

16. Click on the **Preview For Sheet** list box, and then on the sheet that you want to preview. In our example, a total of 91 plates are created across two sheets. The first sheet of fifty plates appears as shown below:

46	47	48	49	50
41	42	43	44	45
36	37	38	39	40
31	32	33	34	35
26	27	28	29	30
21	22	23	24	25
16	17	18	19	20
11	12	13	14	15
6	7	8	9	10
1	2	3	4	5

The number marked by a red square  indicates the currently selected plate. Click to select the plate for which you want to set its variables.

17. In the **Variables Section** area, you can see a list box for each of the variables that you have created as vector text enclosed in curly braces, as part of the template vector artwork.

In our example, list boxes labelled as *name* and *title* are created. These labels match the vector text enclosed in curly braces drawn in our model.

Each of these list boxes contains options for the data found in the field headings of the imported text file. Click on each of the list boxes, and select an option to define the properties of each variable. Each list box also has two default options. These are as follows:

- **None** – Click on this option if you want to define your own data.

- **Number** – Click on this option if you want to set the variable as a numeric value. If you use this option, set the number from which you want to begin counting in the **Start Value** box, and the difference that you want to set between each consecutive number in the **Increment** box. You can use both whole and decimal numbers. You can also define the number of zeroes preceding the start value and following any value after a decimal point in the **Format** boxes.

In our example, we click to select the *ContactName* option from the *name* list box and the *ContactTitle* option from the *title* list box.

When you create the sheet of plates, the field headings from the imported text file assigned to the variables defined in the template vector artwork are created as vector text in the same position as these variables.

The data beneath the field headings from the text file that are assigned to each variable will be created as vector text throughout the sheet of plates. The vector text is created in the same style and position as the variables that you created as vector text enclosed in curly braces.

18. In the **Plate Values** area, you can edit the variables that will be created as vector text on each plate on the sheet. Select the plate for which you want to edit its variables. You can either:
  - Define the plate number in the **Plate No.** box.
  - Click to select the plate from the matrix preview. Its number is displayed in the **Plate No.** box.

With the plate selected, you can now type in each of the boxes displayed for each variable associated with the plate. For example, name, age and address. Click on the **Update** button to confirm any changes that you have made to the variables.

19. Click on the **Create Plates** button to create the sheet of plates. The data used for the selected variables appears as vector text on each plate in the same position.



In our example, the two sheets of plates and the default sheet containing our original vector artwork and toolpath preview appear as follows:



PlateSheet1

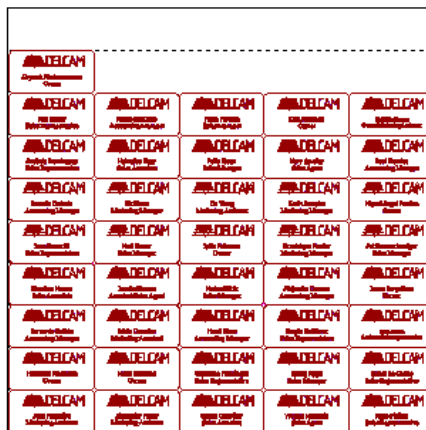

PlateSheet2



Default Sheet

The vector text created is constrained by default to ensure that all of the text fits within the vector representing the plate. For further details, see "Formatting Vector Text" in the Working with Vectors chapter. Each sheet of plates is created on a separately in the model. Each of these sheets are named *PlateSheet* by default, numbered consecutively, and assigned the colour black. Each sheet of plates is listed on the **Layers** page. The last sheet is displayed by default. For further information, see "Working with Layers" on page 110.

You can control which sheet of plates is shown in the **2D View** window by clicking to select the name of the specific *PlateSheet* you want to view from the **Active Sheet** list box. You can only view one sheet of plates at a time. You can only edit the vector artwork on the active sheet.

The arrangement of the rows and columns of sheets shown in the **2D View** window will vary according to the most economical use of the available space.

In our example, two sheets are created in total.

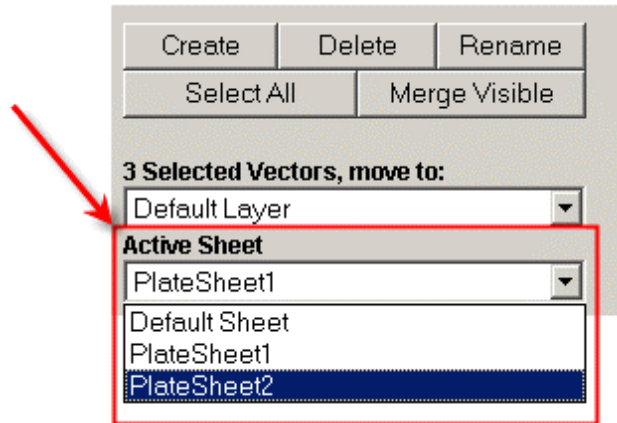

After the vector artwork for the plates has been created, the **Create Toolpaths** button is displayed at the bottom of the page.

20. Make sure that all of the vector artwork and the toolpath preview(s) shown in the **2D View** window are selected.
21. Click on the **Create Toolpaths** button to calculate the toolpaths needed to machine the plates.

A separate toolpath is calculated for each of the sheets in the model. This allows you to save each the toolpaths associated with each sheet as a separate toolpath file.



---

**Note:** You can use the **Previous** icon  to return to the previous page of settings.

---



---

**Note:** You can also use the **Close** icon  to return to the **Assistant's Home** page.

---

## Correcting an Action

You can perform a sequence of relief or bitmap editing techniques in order to correct your mistakes without having to apply each of your changes in turn.

To cancel each of your consecutive editing actions, working backwards:

- Click on the **Undo** button  in the **File** area of the **Assistant's** Home Page.



---

**Note:** You can also cancel an action by pressing the **Ctrl + Z** keys on your keyboard.

---

To repeat each of the editing actions you have previously cancelled in succession, working forwards:

- Click on the **Redo** button  in the **File** area of the **Assistant's** Home Page.



---

**Note:** You can also redo a cancelled action by pressing the **Ctrl + Y** keys on your keyboard.

---



---

**Note:** Alternatively, click on the **Edit** menu in the Main menu bar, followed by the relative option listed, for example, *Undo Draw Ellipse*.

---

The number of times that you can undo or redo your actions depends on the size of the 'scratch' file associated with ArtCAM Pro, as well as the magnitude of your editing. For example, a sequence of small changes to the relief or bitmap will store more undo actions than larger modifications.

To set the size of the 'scratch' file associated with the **Undo** and **Redo** buttons, see "Managing ArtCAM Pro's Preferences" in the ArtCAM Pro Layout chapter.

## Mirroring a Model

You can mirror an open model both vertically and horizontally.

To mirror a model horizontally:

1. From the Main menu bar, click on the **Model** menu, followed by the **Mirror > Horizontal** option.

To mirror a model vertically:

1. From the Main menu bar, click on the **Model** menu, followed by the **Mirror > Vertical** option.

## Rotating a Model

You can rotate an open model both clockwise and anti-clockwise.

To rotate a model clockwise:

1. From the Main menu bar, click on the **Model** menu, followed by the **Rotate 90 Degrees > Clockwise** option to turn the model through 90° in a clockwise direction.

To rotate a model anti-clockwise:

1. From the Main menu bar, click on the **Model** menu, followed by the **Rotate 90 Degrees > AntiClockwise** option to turn the model through 90° in an anti-clockwise direction.

## Printing a Model

You can print a model as it is shown in the active design window.

To print a model:

1. Click to select the design window that you want to print.
2. From the Main menu bar, click on the **File** menu, followed by the **Print Setup** option to display the **Print Setup** dialog box:

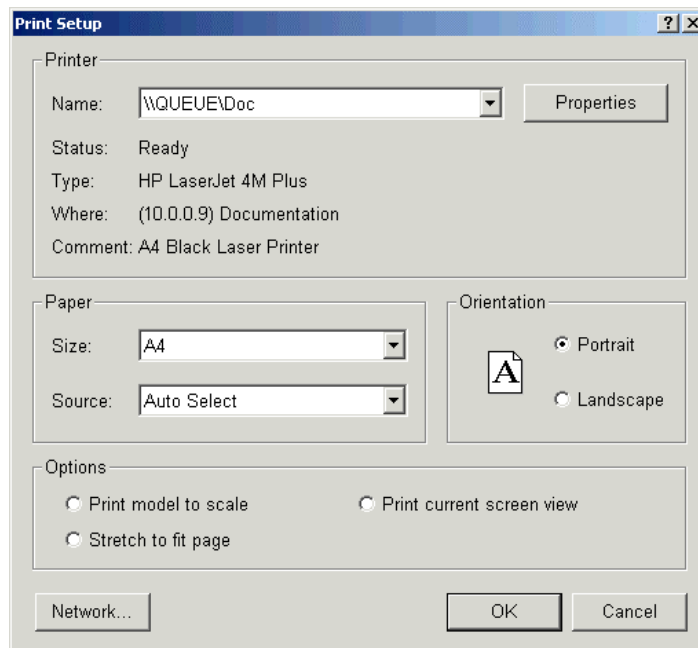

3. Make sure that your printer settings are correct. For details, see "Print Setup" on page 108.
4. In the **Options** area, click on the print option that you want to use:
  - **Print model to scale** – Click on this radio button  if you want to print the model according to its physical dimensions.

Before printing, make sure that the model can fit onto the paper to which it is currently being printed. For details, see "Print Setup" on page 108.

- **Stretch to fit page** – Click on this radio button  if you want to print the model according to the dimensions of the paper onto which it is to be printed.
- **Print current screen view** – Click on this radio button  if you want to print the model as it currently appears in the **2D View** window.



---

**Note:** If you are printing the **3D View** window, the print options are automatically greyed-out. In this instance, ArtCAM Pro prints to fit the **3D View** window in its current orientation.

---

5. Click on the **OK** button to close the **Print Setup** dialog box and print the active design window.

## **Print Preview**

You can view the content of the active design window as it would appear when printed.

To create a print preview:

1. Click to select the design window that you want to print.
2. From the Main menu bar, click on the **File** option, followed by the **Print Preview** option to display a preview image of the active design window.
3. You can use the buttons in the bar at the top of the **ArtCAM Pro** window to view the preview image in more detail:
  - To show the next page of the preview image, click on the **Next Page** button. If this is greyed out, there are no further pages.
  - To show the previous page in the preview image, click on the **Prev Page** button. If this is greyed out, there are no further pages.
  - To show two pages in the preview image at the same time, click on the **Two Page** button. If this is greyed out, there is only one page in the preview image.
  - To enlarge the size of the preview image, click on the **Zoom In** button.

You can also move the  cursor over the area you want to enlarge, and then click.

- To reduce the size of the preview image, click on the **Zoom Out** button.
4. You are now ready to print the preview image:
    - If you want to print the preview image, click on the **Print** button. For further information, see "Printing a Model" on page 106.
    - If you do not want to print the preview image, click on the **Close** button.

## **Print Setup**

You can control the settings for the printer to which the content of the active design window is printed in ArtCAM Pro.

To adjust the printer settings:

1. Click to select the design window that you want to print.
2. From the Main menu bar, click on the **File** menu, followed by the **Print Setup** option to display the **Print Setup** dialog box:

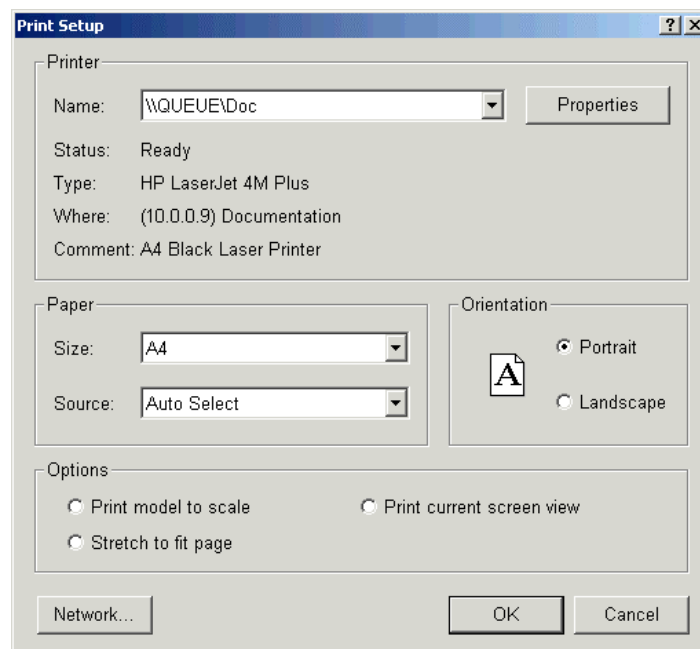

3. Click on the **Name** list box and then on the printer that you want to use.

If you want to change any of the default settings of the printer, such as the paper size and orientation, click on the **Properties** button.

4. In the **Paper** area, click on the **Size** list box and select the size of paper that you want to print to.
5. In the **Paper** area, click on the **Source** list box and then on the tray or paper feed option that you want to use when printing.
6. Select the orientation that you want to use when printing:
  - **Portrait** - Click on this radio button  if you want to print the model vertically. Typically, portrait orientation is used for models that are taller than they are wide.
  - **Landscape** - Click on this radio button  if you want to print the model horizontally. Typically, landscape orientation is used for models that are wider than they are tall.
7. In the **Options** area, click on the print option that you want to use:
  - **Print model to scale** – Click on this radio button  if you want to print the model according to its physical dimensions.

Before printing, make sure that the model can fit onto the paper to which it is currently being printed.
  - **Stretch to fit page** – Click on this radio button  if you want to print the model according to the dimensions of the paper onto which it is to be printed.
  - **Print current screen view** – Click on this radio button  if you want to print the model as it currently appears in the **2D View** window.



---

**Note:** If you are printing the **3D View** window, the print options are automatically greyed-out. In this instance, ArtCAM **Pro** prints to fit the **3D View** window in its current orientation.

---

8. Click on the **OK** button to print the active design window and close the **Print Setup** dialog box.

---

# Working with Layers



All models have a single default layer. You can, however, add as many layers as you want. This allows you to view only the vector objects you are interested in at any given time, clearing the **2D View** window of all unnecessary detail.

Layers are seen in the **2D View** window only. Using the **Layers** page, you can:

- Create a layer to represent each part of the model that you are creating. For details, see "Creating a New Layer" on page 110.
- Name a layer to identify the vector objects on it. For details, see "Naming a Layer" on page 111.
- Assign a colour to a layer, which is used for all vector objects on it. For details, see "Assigning a Colour to a Layer" on page 111.
- Hide layers, allowing you to isolate the part of the model that you want to work on. For details, see "Viewing a Layer" on page 113.
- Lock the vectors on a layer into position, or unlock them. For details, see "Locking the Vectors on a Layer" on page 114.
- Align vector object on a layer with another vector object on any visible layer or a guideline using snapping. For details, see "Snapping on a Layer" on page 114.

## Creating a New Layer

The **Default Layer** for the model is listed on the **Layers** page, and its default colour is black. You can change this colour at any time. For details, see "Assigning a Colour to a Layer" on page 111.

You can create up to 990 layers in a model. For all of the layers that you create, the Visibility  and Snapping  options are selected by default, the Locking option  is deselected and it is coloured black. For further information, see "Manipulating Layers" on page 112.

To create a new layer:

1. Click on the **Layers** tab  to display the **Layers** page.





---

**Tip:** You can toggle between the **Assistant** page and the **Layers** page using the **F7** key on your keyboard.

---

2. Click on the **Create** button to add a layer to the model. It is named *Layer* by default, and is numbered sequentially.
3. Type a name for the new layer.
4. Click on the  button to apply the name to the layer. If you want to change the name, click on  button, then follow the steps in "Naming a Layer" on page 111.

## Naming a Layer

The name of a layer should reflect what the vector objects in it are used for in a model. You can change the name of any layer, other than the **Default Layer**, at any time. To do so:

1. Click on the **Layers** tab  to display the **Layers** page.
2. Click on the layer on the page that you want to rename to select it. It is highlighted in blue.



---

**Note:** You cannot rename the **Default Layer**.

---

3. Click on the **Rename** button.
4. Type over the current name with the name for the layer.
5. Click on the  button to apply the name to the layer. If you want to change the name, click on  button and repeat the previous step.

## Assigning a Colour to a Layer



You can assign a colour to a layer. Once you have done so, all of the vector objects in the layer are shown in that colour. This allows you to easily recognise what vector objects in the **2D View** window belong to a specific layer in the model.



---

**Tip:** Avoid using blue, magenta or red when assigning a colour to a layer. This is because these colours are used in the program when you select vector objects or view toolpath previews. For details, see "Selecting Vectors" in the Working with Vectors chapter and "Selecting Toolpaths" in the Machining Models chapter.

---

1. Click on the **Layers** tab  to display the **Layers** page. Each new layer is coloured black by default.
2. Click on the  button for the layer whose colour you want to change. The **Color** dialog box is displayed:

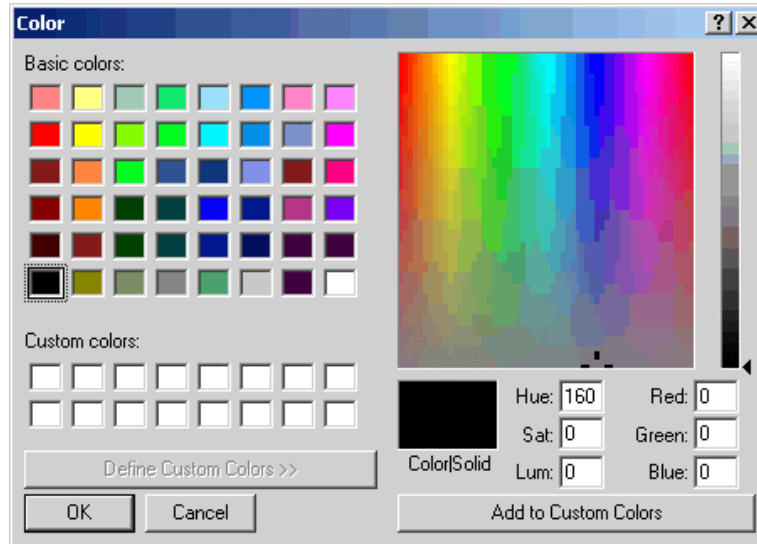

3. Select the colour that you want to use for the layer.
 

To select a Basic colour:

  - Click on a colour in the **Basic Colors** palette.

To select a Custom colour:

  - Click on an approximate colour in the Colour Matrix, then click and drag on the slider at the right of the dialog box to adjust the colour's attributes.
  - Type values in the **Hue**, **Sat** (Saturation) and **Lum** (Luminosity), or the **Red**, **Green** and **Blue** boxes to specify the colour.
  - Click on the **Add To Custom Colors** button to add the colour to the **Custom Colors** palette.
4. Click on the **OK** button to close the **Color** dialog box and set the colour of the vector objects in the layer.

## Manipulating Layers

You can change the settings for a layer using the buttons associated with it.

- Hide a layer from view. For details, see "Viewing a Layer" on page 113.

- Lock vector objects on a layer into position. For details, see "Locking the Vectors on a Layer" on page 114.
- Snap one vector object on a layer in relation to another. For details, see "Snapping on a Layer" on page 114.
- Move vector objects from one layer to another. For details, see "Transferring Vectors Between Layers" on page 114.
- Merge one layer with another. For details, see "Merging Layers" on page 115.

## Viewing a Layer

You can turn the visibility for a layer on and off. When a layer is visible, the vector artwork drawn on the layer is shown in the particular colour assigned to the layer.



---

**Note:** You only hide the vector objects on a layer. If you also want to hide a toolpath preview associated with a vector object, see "Hiding a Toolpath" in the Machining Models chapter.

---





---

**Note:** You cannot merge a layer with another when its visibility is deselected . For details, see "Merging Layers" on page 115.





---



---



**Note:** If you try to create a vector object on an active layer in which the visibility is deselected , the visibility is automatically selected .

---

- Click on the **Toggle Visibility** button  to hide the contents of a layer.
- Click on the **Toggle Visibility** button  to show the contents of a layer.
- Click on the **Toggle All Visibility** button  to simultaneously hide the contents of all the layers that make up the model.
- Click on the **Toggle All Visibility** button  to simultaneously show the contents of all the layers that make up the model.

## Locking the Vectors on a Layer

You can lock or unlock selected vector objects on a layer, so that they cannot be moved within it. Locking, however, does not prevent you from transferring vector objects from one layer to another.

- Click on the **Toggle Locking** button  to lock the selected vector objects on a layer.
- Click on the **Toggle Locking** button  to unlock all locked vector objects on a layer.

## Snapping on a Layer

Using snapping, you can align a vector object on the active layer with another vector object on any visible layer or a guideline. For further information on guidelines, see "Using Guidelines" in the ArtCAM Pro Layout chapter.





---

**Note:** The **Snap To Objects** option in the **2D View** menu must be selected  **Snap To Objects** to use the **Toggle Snapping** button  on the **Layers** page. For details, see "Snapping To Objects" in the ArtCAM Pro Layout chapter.

---

You can turn the snapping for a layer on and off.

- Click on the **Toggle Snapping** button  to select snapping on the layer.
- Click on the **Toggle Snapping** button  to deselect snapping on the layer.



---

**Tip:** To temporarily disable snapping, hold down the **Shift** key on your keyboard.

---

For details on how the mouse cursor changes when it snaps, see "Snapping To Objects" in the ArtCAM Pro Layout chapter.

## Transferring Vectors Between Layers

You can transfer selected vector objects from one layer to another.

1. Click on the **Layers** tab  to display the **Layers** page.
2. From the **2D View** window, select the vector object(s) that you want to transfer. For details, see "Selecting Vectors" in the Working with Vectors chapter.



---

**Tip:** If you want to transfer all of the vector objects in the selected layer, click on the **Select All** button.

---

3. In the list box at the bottom of the **Layers** page, click to select the layer to which you want to transfer the selected vector objects.

The vector objects are transferred to the chosen layer and are shown in the colour assigned to it.

## **Merging Layers**

You can merge all visible layers with an active layer.

1. Click on the **Layers** tab  to display the **Layers** page.
2. Click to select the layer with which you want all other visible layers to be merged. It is highlighted in blue.

For example, if you select the default layer, it appears as follows:



3. Make sure that the visibility is deselected  for all of the layers that you do not want to merge with the active layer. For details, see "Viewing a Layer" on page 113.
4. Click on the **Merge Visible** button to merge the visible layers.

The visible layers are merged with the active layer. The vector objects from the layers are now shown on the active layer in the colour assigned to it.

## **Deleting Layers**

You can delete any layer, choosing to delete the vector objects on it along with it or to transfer them to another layer:

1. Click on the **Layers** tab  to display the **Layers** page.
2. Click to select the layer that you want to delete. It's name is highlighted in blue.
3. Click on the **Delete** button to display the following message box:

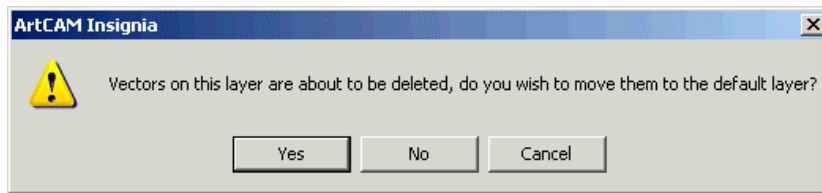

4. If you want to delete the layer along with the vector objects on it, click on the **No** button.

If you want to transfer the vector objects on the selected layer to the default layer before it is deleted, click on the **Yes** button.

---

## Using the Font Editor

ArtCAM Pro allows you to create your own fonts by editing characters within any installed fonts and then saving them. Using ArtCAM Pro's **Font Editor** tool, you can:

- Adjust the contour of characters within a font.
- Create an entirely new font using ArtCAM Pro's vector creation tools.
- Adjust the offset distance and the ascent applied to all characters within a font.
- Set the order in which the vector objects that make up a character will be machined.
- Adjust the kerning (white space) between pairs of characters within a font.
- Save your customised font and then type in it using ArtCAM Pro's **Text Tool**. For further details, see "Working with Vector Text" in the Working with Vectors chapter.



---

**Note:** All customised fonts are listed with an '(AFN)' prefix in the **Font** list box on the **Text Tool** page.

---

To create a customised font:

1. Click on the **Font Editor** icon  on the **Assistant's Getting Started** page to display the **Font Editor** page.



---

**Note:** You can click on the **Back** icon  to return to the **Assistant's Getting Started** page.

---

2. Select the font that you want to edit. This is referred to as the base font.

If you want to edit a TrueType font:

- First, click on the **Base Font** list box, and then on the font that you want to edit.
- Next, click on the **Script** list box below, and then on the script option that you want to use for the font.
- Finally, click on the **Create** button.

If you want to edit an AutoCAD shape file (\*.shp):

- First, make sure that the **Open for editing** option is selected .
- Now, click on the **Import** button to display the **Import** dialog box:

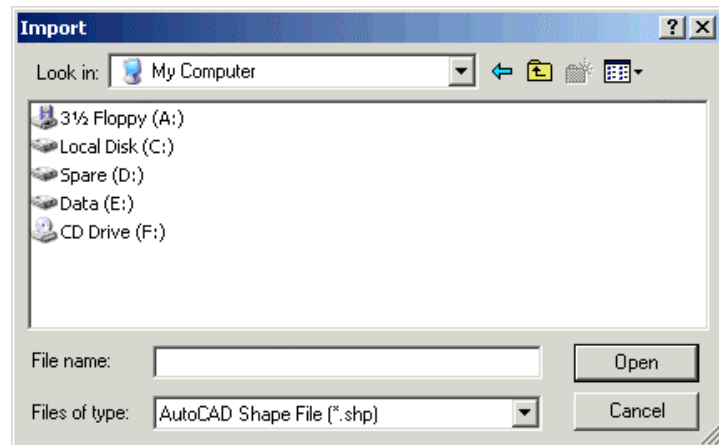

- Next, click on the **Files of type** list box, and then on the file type of the AutoCAD shape you want to open.
- Next, click on the **Look in** list box and select the directory where the AutoCAD shape file that you want to open is stored. Once you have found the file, click on its name.
- Finally, click on the **Open** button.

A new ArtCAM model is created and the **Font Creator** page is displayed. All of the characters within the selected font appear as vector objects in the **2D View** window.

For example, the characters that make up the Arial Western font appear as shown below:



---

**Note:** You can toggle the grid of guidelines off and on by clicking on the  button where the horizontal and vertical rulers meet.

---

3. If you cannot see the character that you want to edit, click on the **View Page** list box, and then on the next page number. Repeat this step until you have found the character. For Unicode fonts, each page contains 256 characters.
4. Select the character that you want to edit. You can either:
  - Type the character or its code number in the **Choose Character** box, and then click on the **Edit Character** button.
  - Click on the character itself in the **2D View** window.

Only the selected character is now shown in the model area (the white area) of the **2D View** window. The vector objects that make up the character are now ungrouped. Red, purple and green guidelines are shown by default.

In our example, the lower-case character 'p' is selected, as shown as follows:



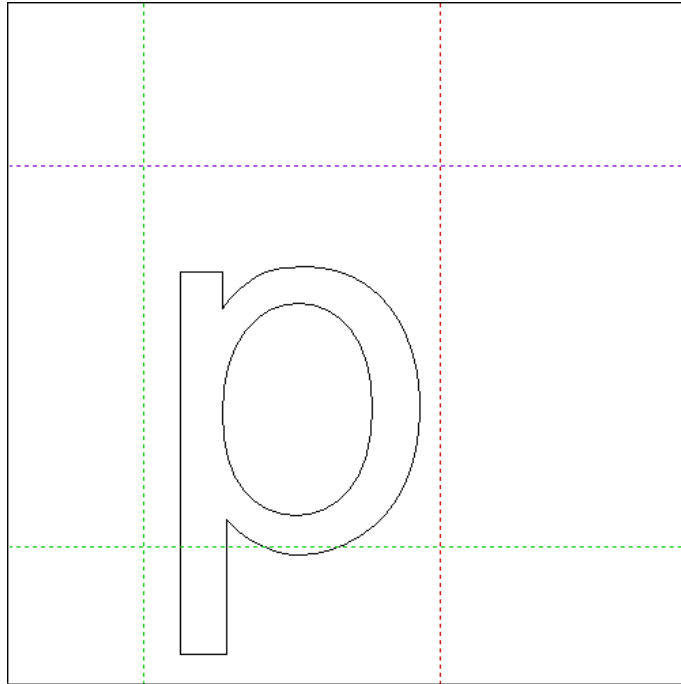

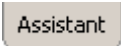
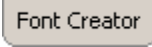
5. Click on the **Assistant** tab  and use the available vector tools to edit the selected character. A character can be edited in the same way as any other vector object in ArtCAM Pro. For further information, see "Editing Vector Objects" in the Working with Vectors chapter.
6. Click on the **Font Creator** tab  to display its settings. You can now adjust the offset and the ascent for the font using the currently selected character:
  - To adjust the offset distance between the current character and the next in the font, click and drag the red guideline into position.
  - To adjust the ascent of the font to which the current character belongs, click and drag the purple guideline at the top and the green guideline at the bottom of the font into position.
  - To restore the default position of all guidelines, click on the **Reset Guides** button.





---

**Tip:** Make sure that the purple guideline is aligned with the top edge of the capital 'H' or 'M' character in the font. The green guidelines should be aligned with the left and bottom edges of the capital character.

---

7. If you want to set the order in which the character's vector objects will be machined, click on the **Set Vector Order**

button to display the settings in the **Assistant** window. Each of the character's vector objects is numbered in the **2D View** window, showing the total number of vector objects and the current order in which they will be machined. You can either:

- Move the  cursor over the vector object, and then click on each of the vector objects that make up the character in turn.
  - Click on the **Swap Order** button. Move the  cursor over the vector object whose position you want to alter, and then click. Its current position in the machining order is displayed on the mouse cursor, replacing its left question mark. Click on the vector object whose position you want to exchange with that which is already selected. The selected vector objects are renumbered according to their new positions in the overall machining order.
8. If you want to adjust the kerning between the selected character and another within the font:



---

**Note:** A list of characters that have been kerned by default along with the selected character are shown in the **Currently Kerned Characters** area of the page. You can click on any of the listed characters to display them along with the selected character in the **2D View** window.

---

- First, type the new character or its code number in the **Edit Kerning for Character** box, and then click on the **Edit Kerning** button. The new character appears alongside the previously selected character in the **2D View** window.

In our example, the upper-case characters 'A' and 'W' appear as follows when selected:

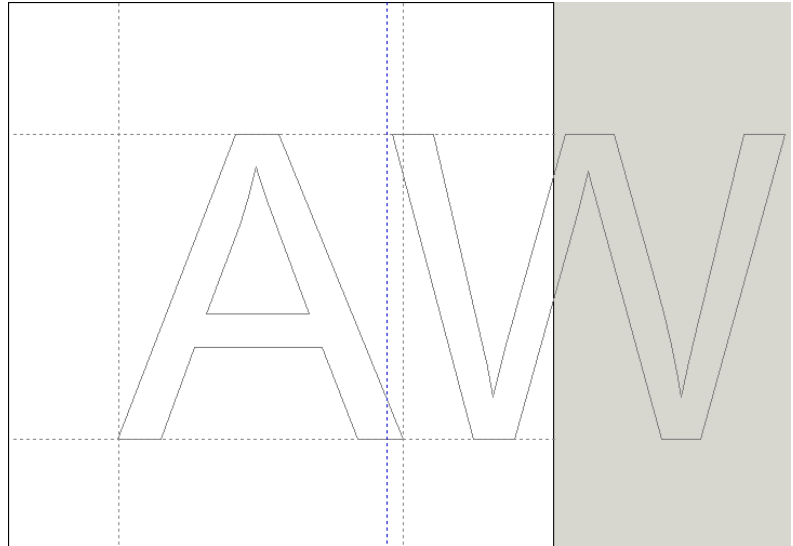

- Next, click and drag the blue guideline to set the distance between the pair of characters. Drag to the left to move the characters closer together, and to the right to move them further apart.





---

**Note:** This action only adjusts the kerning for the currently selected pair of characters in the font.

---

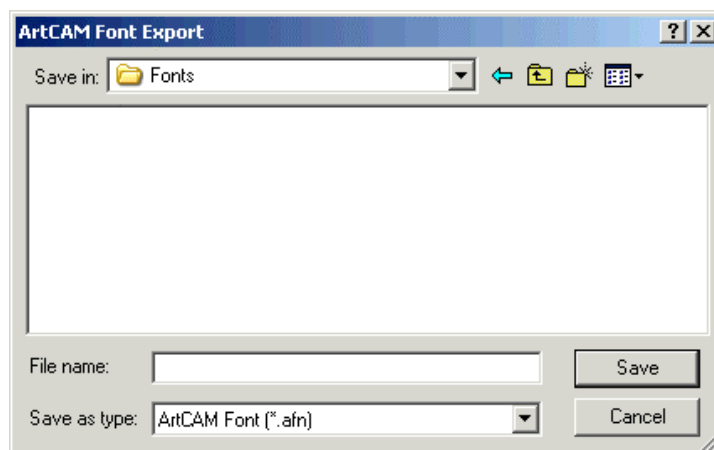
- Finally, click on the **Done** button to return to the **Edit Character** settings.
9. Click on the **Done** button. The **Choose Character** options are displayed on the page and all of the characters within the selected font are shown again in the **2D View** window.
  10. Repeat these steps until you have finished editing characters in the font. When you have finished, click on the **Save Font** button to display the **ArtCAM Font Export** dialog box:



The ArtCAM Pro 8.0\Fonts folder is selected by default.

11. Type a name for the font in the **File Name** box, and then click on the **Save** button to close the **ArtCAM Font Export** dialog box and save the font (\*.afn).
12. Click on the **Quit** button to return to the **Assistant's Getting Started** page.



---

**Note:** If you click on the **Quit** button before saving the font, a message box appears warning that the font has been modified. If you want to save the font, click on the **Yes** button. If you do not, click on the **No** button.

---



---

## Using the Face Wizard

ArtCAM Pro allows you to create a relief from a photographic image containing a side-profile of a person's head and neck saved as a Bitmap (\*.bmp), TIFF (\*.tif), GIF (\*.gif) or JPEG (\*.jpg) file. This process is almost entirely automated.

To produce a detailed relief, your image should ideally be captured by a digital source using a resolution of at least 1024 x 768 pixels. Colour photographic images can be imported, but they will appear as black and white in ArtCAM Pro.

To create a relief using the Face Wizard tool:

1. Click on the **Face Wizard** icon  on the **Assistant's Getting Started** page to display the first page of the **Face Wizard**.
2. Click on the **Open Photo...** icon  to display the **Select Image File** dialog box:

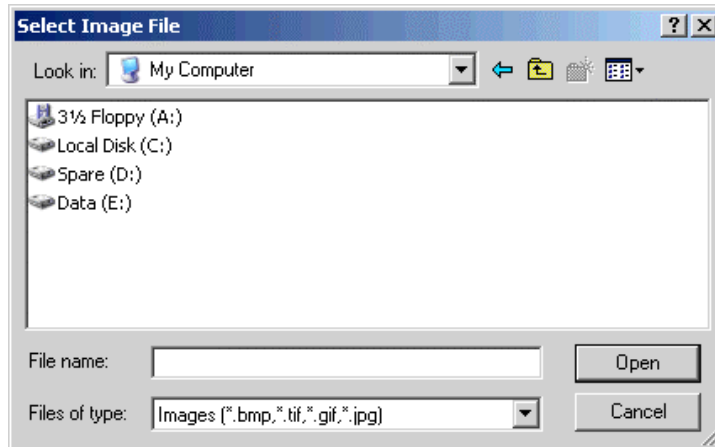

3. Click on the **Look in** list box and select the directory in which the image file from which you want to create a relief is stored.
4. Once you have found the image file from which you want to create a relief, click on its file name. Its name appears in the **File Name** area.
5. Click on the **OK** button to import the image into ArtCAM Pro and display the second page of the Face Wizard.

For example, we will use the following TIFF image:



You are now ready to create a vector object to mark the outline of the head and neck shown in the imported image.

6. Click on the **Create Polyline Tool** button  on the Face Wizard page to enter polyline creation mode. For

further information, see "Creating a Polyline" in the Working with Vectors chapter.

If you want ArtCAM Pro to join each point with a bezier span, click to select the **Draw Smooth Polyline** option  before creating the polyline.



7. In the **2D View** window, click and drag your mouse to create a freeform polyline around the head and neck of the person shown in the imported image.



---

**Note:** You can use the **Bitmap On/Off** button  in the **2D View** toolbar to show and hide the imported image. This will allow you to view the polyline more clearly.

---

8. Use the Join Vectors buttons to close the polyline as required:
  - Click on the **Close Vector With A Line** button  to close the polyline with a linear span
  - Click on the **Close Vector With A Curve** button  to close the polyline with a bezier curve.
  - Click on the **Close Vector – Move End Points** button  to close the polyline by joining its start and end points.

The polyline is shown in magenta and surrounded by a bounding box, indicating that it is closed and selected.



In our example, the polyline is drawn as follows:

*Polyline, Image Displayed...*



*Polyline, Image Hidden...*

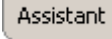

9. Click on the **Assistant** tab  to display the **Assistant's** Home page.
10. Click on the **Node Editing** button  in the **Vector Editing** area to enter Node Editing mode. You can see the points (nodes), control points and spans that make up the polyline you have drawn.
11. Click on the **Add In** tab  to return to the second page of the Face Wizard tool.
12. Edit the shape of polyline so that it follows the outline of the face area perfectly, or is even a pixel distance inside of the face area. For further information, see "Editing Vector Spans" and "Editing Vector Nodes" in the Working with Vectors chapter of the Reference Manual.
13. Click on the **Next** button to display the third page of settings. You are now ready to define points to identify specific facial features in the image.
14. Click to select the position on the image that you want to define as the centre-front of the person's eyebrow. The selected point must be on or inside of the polyline that you have drawn. The selected point is marked by a red square.
15. Click to select the position on the image that you want to define as the nape of the neck. The selected point must be on or inside of the polyline that you have drawn. The selected point is marked by a red square.



---

**Note:** You can use the **Bitmap On/Off** button  in the **2D View** toolbar to show and hide the imported image. This will allow you to view the selected points more clearly.

---

If you want to change the position of either of the selected points, click on the **Remove Points** button and repeat the previous two steps.

In our example, the following points are defined:

*Points, Image Displayed...*

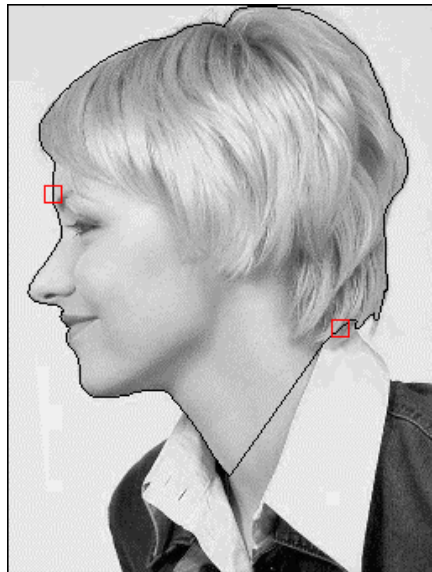

*Points, Image Hidden...*

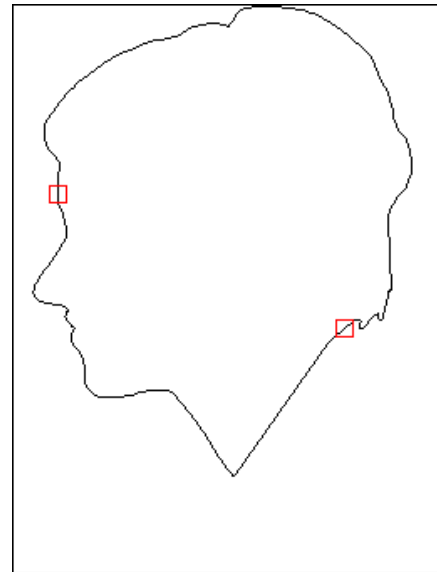

16. Click on the **Next** button to display the fourth page of settings.
17. In the **Head Dimensions** area, define the height and width of the relief.
18. In the **Model Dimensions** area, define the height and width of the ArtCAM model in which you want to create the relief.
19. Click on the **Next** button to calculate the relief.

During the relief calculation process, a progress bar and a cancel button are displayed beneath the design window area:



If you want to stop this process, click on the **Cancel** button .

The calculated relief is shown in the **3D View** window, and the **Interactive Sculpting** page is displayed in the **Assistant** window.



In our example, the following relief is shown in the **3D View** window:



The area of the image shown within the polyline is projected onto the relief by default.

20. Use the **Interactive Sculpting** tools to edit the relief shown in the **3D View** window. For further information, see "Sculpting a Relief" in the Working with Reliefs chapter.
21. Click on the **Finish** button to return to the **Assistant's** Home page.

In our example, the sculpted relief is shown as follows:



# Working with Bitmaps

---

## Drawing using Bitmaps

When you have created or opened an ArtCAM model, you can use the drawing and painting tools in the **Bitmap Editing** area of the **Assistant's** Home page and on the **Bitmap** toolbar to create your own bitmap images.

The bitmap images you create can be used to create the three-dimensional shapes that make up the relief within an ArtCAM model, to edit the relief in a variety of ways, and ultimately machine a 3D model. For more information, see the Working with Reliefs chapter.

## Bitmap Drawing Tools

A bitmap image, or raster graphic, is made up of pixels in a grid. Pixels are picture elements; tiny dots of individual colour that make up the images that you see on your screen. Bitmap images are resolution dependent. Resolution refers to the number of pixels in an image and is usually stated as d.p.i. (dots per inch). Since bitmap images are resolution dependent, it is difficult to scale them to a larger size without sacrificing a degree of quality.

In ArtCAM Pro, you can edit imported bitmap images or create your own. The group of bitmap tools is found on the **Bitmap** toolbar:



You can also find a selection of the tools featured in the **Bitmap** toolbar in the **Bitmap Editing** and **Vector – Bitmap** areas of the **Assistant's** Home page.

---

## Creating a Model from a Bitmap

You can create an ArtCAM model by importing any the following types of image files: Bitmap (\*.bmp), TIFF (\*.tif), GIF (\*.gif) and JPEG (\*.jpg). ArtCAM automatically calculates a relief from the imported image. For details, see "Creating a Model from an Image" in the Working with Models chapter.

---

## Importing a Bitmap into a Model

In ArtCAM Pro, you can import any the following types of image files into a model: Bitmap (\*.bmp), TIFF (\*.tif), PCX (\*.pcx), GIF (\*.gif) and JPEG (\*.jpg). For details, see "Importing Images" in the Working with Models chapter.

---

## Setting a Bitmap's Size and Origin

You can change the size of a bitmap image imported into ArtCAM Pro. In resizing the bitmap image, you also set the size of the vector objects that can be created from it.

There are three ways to set the size of a bitmap image imported into ArtCAM Pro, all of which are done via the **Set Model Size** dialog box.



---

**Note:** Changing the size of the image does not alter the resolution of the original bitmap you imported into ArtCAM Pro. The image retains the same number of pixels as the original.

---

You can also set the origin of an imported bitmap image to any one of five preset positions in ArtCAM Pro. Each of these positions determines where the vector objects you create from the bitmap image are positioned in the model. For details on how to use the **Set Model Size** dialog box, see "Editing the Model Dimensions" in the Working with Models chapter.

---

## Working with Colours

Whenever you create or open an existing ArtCAM model, a default Colour Palette is displayed beneath the **2D View** window:



When you have imported a bitmap image, all of the colours within the image are displayed in the Colour Palette below the **2D View** window.

ArtCAM Pro allows you to manipulate the colours within a bitmap image. You can:

- Select the Primary and Secondary colours from the Colour Palette. For details, see "Selecting the Primary and Secondary Colours" on page 131.
- Reduce the number of colours in a bitmap image. For details, see "Reducing Colours" on page 132.
- Link colours within a bitmap image. For details, see "Colour Linking" on page 134.
- Merge colours within a bitmap image. For details, see "Colour Merging" on page 133.
- Mark the edge of a bitmap image. For details, see "Edge Marking" on page 135.
- Thicken colours within a bitmap image. For details, see "Colour Thickening" on page 136.
- Thin colours within a bitmap image. For details, see "Colour Thinning" on page 135.
- Add colours to the Colour Palette. For details, see "Adding Colours" on page 137.
- Save a custom Colour Palette. For details, see "Saving a Custom Colour Palette" on page 139.
- Load a custom Colour Palette. For details, see "Loading a Custom Colour Palette" on page 139.

## Selecting the Primary and Secondary Colours

The Primary Colour defines the shape of the vector objects or the three-dimensional shapes you can create from a bitmap image. ArtCAM Pro can create vector objects around the outline of all areas in the Primary Colour, along with those colours to which it is linked.

The Primary Colour controls the colour of the **Paint** and **Draw** tools. You can use the Secondary Colour only when painting, drawing or editing a bitmap image.

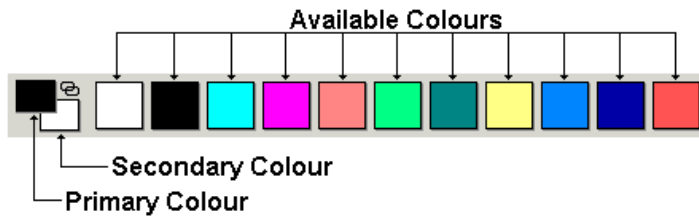

The Primary and Secondary colours are also used to define the areas in a relief that you do or do not want to edit.

You can select the Primary and Secondary colours from the Colour Palette beneath the **2D View** window:





You can also select the Primary and Secondary colours from the bitmap image itself using the **Pick Colour** tool.

To select the Primary Colour, you can either:

- Click on the colour in the Colour Palette you want to use.
- Click on the **Pick Colour** button  in the **Bitmap** toolbar, move the dropper  over the colour in the bitmap image that you want to select, and then click.

To select the Secondary Colour, you can either:

- Right-click on the colour in the Colour Palette you want to use.
- Click on the **Pick Colour** button  in the **Bitmap** toolbar, move the dropper  over the colour in the bitmap image that you want to select, hold the **Shift** key down on your keyboard, and then click.

## Reducing Colours

You can reduce the number of colours in a bitmap image. ArtCAM Pro takes colours of a similar shade and from them produces an averaged colour. This averaged colour is displayed in the Colour Palette in place of the original colours.



---

**Note:** Colour reduction should be done as an iterative process so that the number of colours can be minimised whilst preserving the detail in the original bitmap image.

---

To reduce the number of colours in a bitmap image:

1. Click on the **Reduce Colours** button  in the **Model** area of the **Assistant's** Home page to display the **Reduce Number Of Colours In Image** dialog box:



2. Define the new number of colours in the **New Maximum Number Of Colours For Image** box.  
The default number is always one less than that shown in the greyed-out **Current Number Of Colours In Image** box.
3. Click on the **OK** button to close the **Reduce Number Of Colours In Image** dialog box and reduce the number of colours in the bitmap image to that specified.



---

**Warning:** Reducing the number of colours in a bitmap image resets all colour links and attributes. If you want to keep any new or linked colours you have created, do not click on the **OK** button.

---

## Colour Merging

You can merge all of the pixels within a bitmap image in the Secondary Colour with the Primary Colour. The Secondary Colour is then removed from the Colour Palette beneath the **2D View** window.



To do so:

1. Click on the colour within the Colour Palette that you want to select as the Primary Colour.
2. Right-click on the colour within the Colour Palette you want to select as the Secondary Colour.
3. Click on the **Merge Colours** button  in the **2D View** toolbar to merge the current Secondary Colour with the current the Primary Colour. The Secondary Colour is removed from the Colour Palette altogether.

## Colour Linking

You can both link and unlink colours within the Colour Palette beneath the **2D View** window. When a colour in the Colour Palette is linked to the Primary Colour, it is treated as the Primary Colour for as long as it is linked to it.

There are three ways you can link a colour in the Colour Palette with the current Primary Colour:

- Click on the **Link/Unlink** button  to link the Secondary Colour to the Primary Colour.
- Click on the **Link/Unlink** icon  in the Colour Palette to link the Secondary Colour to the Primary Colour.
- Double right-click on the colour in the Colour Palette that you want to link to the Primary Colour.

You can see that colours are linked to the Primary Colour when shown in the Colour Palette as follows:

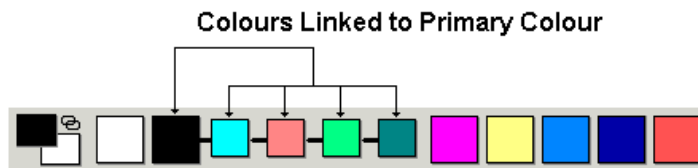

When colours are linked to the Primary Colour, they are displayed within the image in the Primary Colour.

### ***Linking All Colours***

By clicking on the **Link All Colours** button , you can simultaneously link all colours currently in the Colour Palette, other than the Secondary Colour, to the Primary Colour.



---

**Tip:** Depending on how many colours there are you want to link, it may be quicker to use the **Link All Colours** method of linking and then use the **Link/Unlink** button  to unlink the individual colours that you do not want.

---

### ***Unlinking All Colours***

By clicking on the **Unlink All Colours** button , you can unlink all colours currently linked in the Colour Palette.



## Edge Marking

You can paint a line around the edge of a bitmap image. Marking the outline of a bitmap image in this way means that its shape is clearly defined when it is converted into vector objects or three-dimensional shapes.

To mark the edges:

1. Click on the colour in the Colour Palette around which you want to paint a line. This colour is now set as the Primary Colour.
2. Right-click on the colour in the Colour Palette that you want to use for painting the outline. This colour is now set as the Secondary Colour.
3. Click on the **Mark Edge** option from the **Colour** menu. A line is painted in the Secondary Colour around all regions in the bitmap image made up of the Primary Colour.

## Colour Thinning

Thinning reduces the width of a colour area, replacing edges with the Secondary Colour. If you select the full thinning process, this reduces the area to a single pixel skeleton. Rather than manually changing an area of colour pixel by pixel, you can automatically thin areas in the Primary Colour.

To thin areas in the Primary Colour:

1. Click on the colour within the Colour Palette you want to select as the Primary Colour.
2. Right-click on the colour within the Colour Palette you want to select as the Primary Colour.
3. From the Main toolbar, click on the **Colour** menu followed by the **Thin...** option to display the **Thin Primary Colour** dialog box:

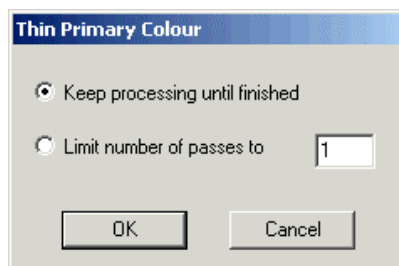

4. Click to select the thinning method you want to use:

- **Keep processing until finished** - This option continues to thin all regions in the Primary Colour until they are reduced to a width of one pixel.
  - **Limit number of passes to** - This option sets a limit on the number of thinning passes according to the value you type in the box. Each pass converts one edge pixel in the Primary Colour to the Secondary Colour.
5. Click on the **OK** button to close the **Thin Primary Colour** dialog box and to thin all regions in the Primary Colour. The **Working** box is displayed while ArtCAM Pro completes the colour thinning process:

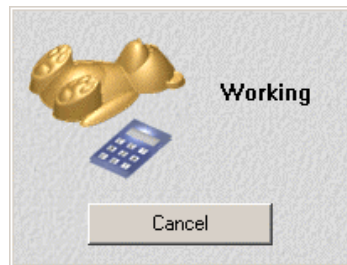

The region of removed pixels is marked in the current Secondary Colour. If you do not need to mark this region, ensure that the Secondary Colour is the same as the background colour in the bitmap image before colour thinning.

## Colour Thickening

Thickening increases the width of a colour area, expanding the borders with the Secondary Colour. Rather than manually changing an area of colour pixel by pixel, you can automatically thicken areas in the Primary Colour.

To thicken areas in the Primary Colour:

1. Click on the colour within the Colour Palette you want to select as the Primary Colour.
2. Right-click on the colour within the Colour Palette you want to select as the Secondary Colour.
3. From the Main toolbar, click on the **Colour** menu followed by the **Thicken...** option to display the **Thicken Colour** dialog box:



4. Define the brush diameter in the **Number of Pixels** box.



---

**Warning:** The brush diameter should be an odd number. Even numbers are automatically rounded up to an odd number.

---

5. Click on the **OK** button to close the **Thicken Colour** dialog box and to apply a round brush of the diameter you have already defined in the current Secondary Colour to each pixel in the current Primary Colour.

The **Working** box is displayed while ArtCAM Pro completes the colour thickening process:

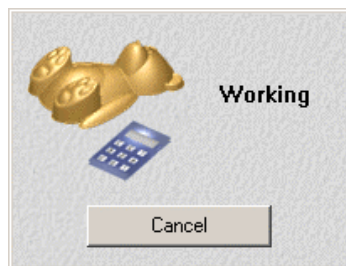

If you want to cancel the colour thickening process at any time, click on the **Cancel** button.

The original pixels in the bitmap image remain in the Primary Colour, while the thickened regions appear in the Secondary Colour. If you do not need this distinction, ensure that both the Primary and Secondary Colours are identical before colour thickening.

## Adding Colours

You can increase the range of colours within the Colour Palette beneath the **2D View** window. You can add Basic Colours and/or create your own Custom Colours for you to paint in.

To add to the Colour Palette:

1. Click on the **Add Colour** button  in the **Bitmap Editing** area of the **Assistant's** Home page to open the **Color** dialog box:

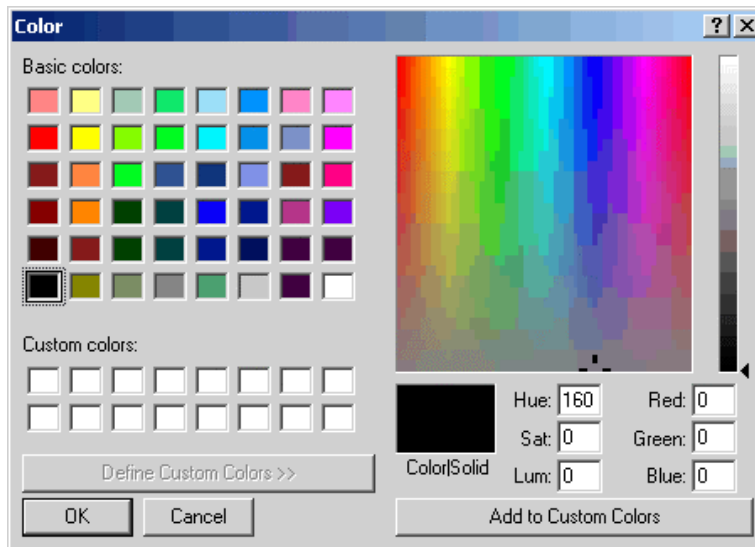

2. Select a colour that you want to add to the Colour palette.  
To select a Basic colour:

- Click on a colour in the **Basic colors** chart.

To select a Custom colour:

- Click on an approximate colour in the Colour Matrix, and then click and drag the slider at the right of the dialog box to adjust the colour's attributes.
  - Type new values in the **Hue**, **Sat** (Saturation) and **Lum** (Luminosity) or the **Red**, **Green** and **Blue** boxes to specify the colour. The colour appears in the **Color/Solid** area of the **Color** dialog box.
3. Click on the **Add To Custom Colors** button to add the colour you have defined to the Custom Colours palette. The colour you have selected appears in the **Custom colors** area of the **Color** dialog box.
  4. Click on the **OK** button to close the **Color** dialog box.

If you try to add a colour that is already in the Colour Palette, the following message box appears:

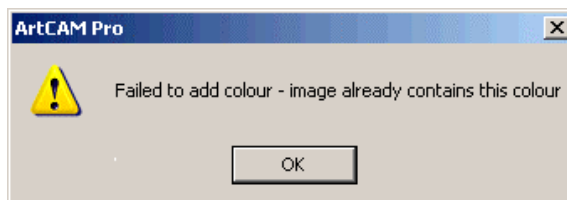

If so, click on the **OK** button to close the message box and add a different colour.

The Basic and/or Custom Colours that you have selected appear in the Colour Palette beneath the **2D View** window.

## Saving a Custom Colour Palette

You can save any custom arrangement of colours you have made in the Colour Palette beneath the **2D View** window as an ArtCAM Palette file (\*.pal).

You can replace the current Colour Palette displayed beneath the **2D View** window with another custom Colour Palette by loading a previously saved ArtCAM Palette file.

To save the Colour Palette that you are currently using:

1. From the Main menu bar, click on the **Colour** menu, and then on the **Save** option to display the **Save As** dialog box.
2. Click on the **Save In** list box and then on the directory in which you want to save the Colour Palette.
3. Type the file name that you want to use for the Colour Palette in the **File name** box.
4. Click on the **Save** button to save the Colour Palette.

## Loading a Custom Colour Palette

You can replace the Colour Palette currently displayed beneath the **2D View** window with another custom Colour Palette by loading a previously saved ArtCAM Palette file (\*.pal).

To load an ArtCAM Palette file:

1. From the Main menu bar, click on the **Colour** menu, and then on the **Load** option to display the **Open** dialog box:

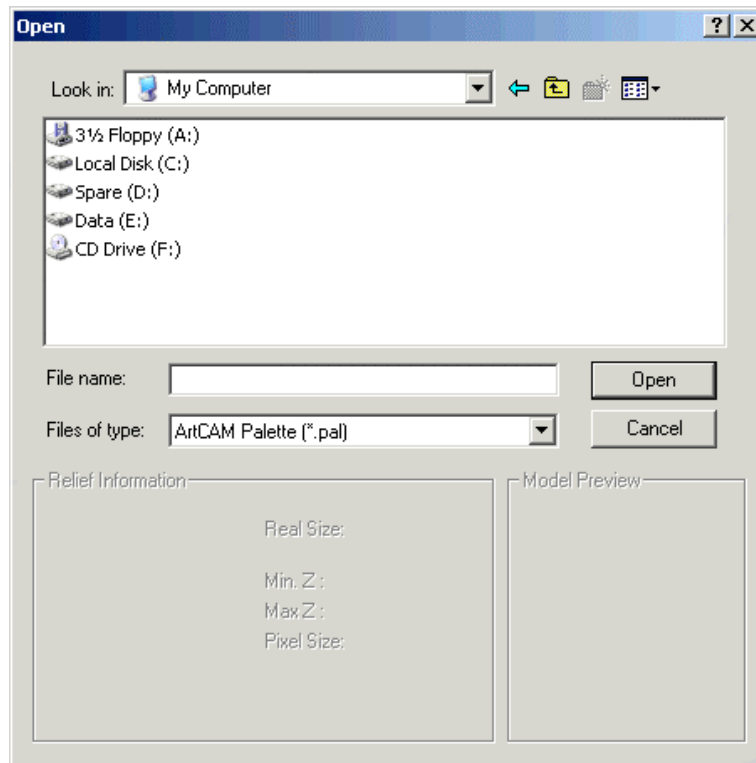

2. Click on the **Look In** list box in the **Open** dialog box and find the ArtCAM Palette file that you want to load.
3. Once you have found the file, click on the file name listed in the main window of the **Open** dialog box. Its name appears in the **File name** box.
4. Click on the **Open** button to display the custom Colour Palette beneath the **2D View** window.

---

## Editing a Bitmap Image



You can change a bitmap image using the painting and drawing tools and the Colour Palette. The painting tools in ArtCAM Pro are a brush and a flood-fill tool. The drawing tools are a pencil and a bitmap-line tool.

### Using the Paint Brush

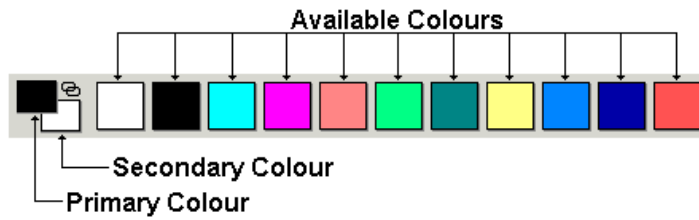
The paint brush allows you to paint in the Primary and Secondary Colours, as shown on the left of the Colour Palette below the **2D View** window:



You can use the paintbrush to modify any bitmap image that you have created or imported into ArtCAM Pro:

1. Click on the **Paint** button  in the **Bitmap Editing** area of the **Assistant's** Home page to enter Paint mode.
2. Set the brush size and shape, as described in "Setting the Brush Size and Shape" on page 141.
3. Move the  cursor over the area of the bitmap image you want to edit, and then click and drag to paint in the Primary Colour.
4. Click on the **Select Vectors** button  in the **Vector Editing** area of the **Assistant's** Home page to exit from Paint mode.

## Setting the Brush Size and Shape

You can change the size and shape of the brush used for painting at any time with the **Brush Size** tool displayed in the **Bitmap** toolbar:

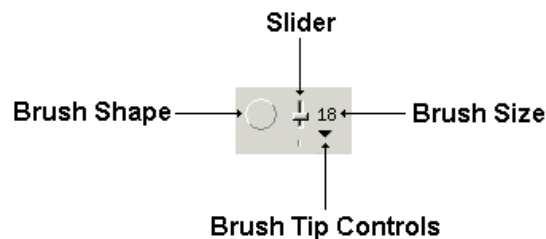

You can change between a square and a circle brush tip simply by clicking on the Brush Shape icon, as shown above.

You can increase the number of pixels that make up the Brush Size by clicking and dragging the slider upwards, or decrease them by clicking and dragging the slider downwards.

You can also change the size and shape of the brush used for painting at any time with the **Brush Diameter** slider and the brush shape icon displayed in the **Bitmap Editing** area of the **Assistant's** Home page:

You can change between a square and a circle brush tip simply by clicking on the Brush Shape icon, as shown above.

You can increase the number of pixels that make up the Brush Size by clicking and dragging the slider upwards, or decrease them by clicking and dragging the slider downwards.

You can also change the size and shape of the brush used for painting at any time with the **Brush Diameter** slider and the brush shape icon displayed in the **Bitmap Editing** area of the **Assistant's** Home page:



You can change between a square and a circle brush tip simply by clicking on the Brush Shape icon, as shown above.

You can increase the number of pixels that make up the Brush Size by clicking and dragging the slider to the right, or decrease them by clicking and dragging the slider to the left.

Alternatively, you can use the Brush Tip controls in the **Bitmap** toolbar to set all of the brush properties:

1. Click on the ▼ arrow of the **Brush Size** tool to display the Brush Tip controls:

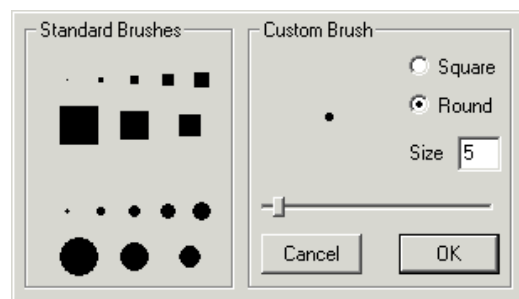

2. Select or create the brush properties. If you want to select a Standard brush:

- Click on any of the square or circle icons to set the size and shape of the brush.

If you want to create a Custom brush:

- First, click on either of the radio buttons  to select the shape of the brush.
- Next, type the number of pixels in the **Size** box, or drag the slider to set the size of the brush.





3. Click on the **OK** button to set the size and shape of the brush and close the Brush Tip controls. You are now ready to paint with your new brush.

## Selective Painting

You can use the **Paint Selective** tool to paint with your brush in the current Primary Colour in all areas of a bitmap image made up of the current Secondary Colour.

To do so:

1. Click on the **Paint Selective** button  in the **Bitmap Editing** area of the **Assistant's** Home page.
2. Click on the colour within the Colour Palette you want to select as the Primary Colour.
3. Right-click on the colour within the Colour Palette you want to select as the Secondary Colour.



4. Move the  cursor over the area you want to paint over, and then click and drag.

All areas of the bitmap image that are of the Secondary Colour are replaced with the Primary Colour. All other colours in the bitmap image remain unchanged.

## Using the Draw Tool

The **Draw** tool allows you to draw a line of one pixel wide in the Primary and Secondary Colours, as shown on the left of the Colour Palette shown beneath the **2D View** window:

You can use the draw tool to create a new bitmap image or to modify a bitmap image that you have imported into ArtCAM Pro:



1. Click on the **Draw** button  in the **Bitmap Editing** area of the **Assistant's** Home page to enter Drawing mode.
2. Move the  cursor over the area of the model that you want to draw in, and then click and drag to draw in the Primary Colour.
3. If you want to draw in the Secondary Colour, hold the **Shift** key down on your keyboard, and then click and drag.

4. Click on the **Select Vectors** button  in the **Vector Editing** area of the **Assistant's** Home page to exit from Draw mode.

## Using the Bitmap Line Tool

The bitmap line tool allows you to draw a line in a bitmap image in the current Primary Colour.

To draw a bitmap line:



1. Click on the **Draw Bitmap Line** button  in the **Bitmap** toolbar to enter Bitmap Line mode.
2. If you want to change the size and shape of the bitmap line tool, you can do so as described in "Setting the Brush Size and Shape" on page 141.
3. Move the  cursor over the area of the bitmap image in which you want to draw a bitmap line, and then click and drag in the appropriate direction. A preview line appears in the **2D View** window.
4. Release the mouse button to draw the bitmap line in the model.
5. Click on the **Select Vectors** button  in the **Vector Editing** area of the **Assistant's** Home page to exit from Bitmap Line mode.

## Using the Erase Tool

The erase tool allows you to remove all or part of your last painting or drawing action from a bitmap image.

To erase all or part of your last painting or drawing action:





1. Click on the **Erase** button  in the **Bitmap** toolbar to enter Erase mode.
2. If you want to change the size and shape of the erase tool, you can do so as described in "Setting the Brush Size and Shape" on page 141.

3. Move the  cursor over the area of the bitmap image that you have drawn last, and then click and drag to erase it.
4. Click on the **Select Vectors** button  in the **Vector Editing** area of the **Assistant's** Home page to exit from Erase mode.

## Flood Filling

You can replace areas of any selected colour with the current Primary Colour, using the **Flood Fill** tool.

To do so:

1. Click on the **Pick Colour** button  in the **Bitmap** toolbar.
2. Move the dropper  over the colour you want to select as the Primary Colour and click.
3. Click on the **Flood Fill** button  in the **Bitmap Editing** area of the **Assistant's** Home page, and then move the roller  over the colour you want to flood fill with the Primary Colour and click. The block of colour you click on is replaced with the Primary Colour.

## Selective Flood Filling

You can flood fill areas of any colour with the current Primary Colour, until it meets pixels of the current Secondary Colour, using the **Flood Fill Selective** tool.

To do so:

1. Click on the **Flood Fill Selective** button  in the **Bitmap Editing** area of the **Assistant's** Home page.
2. Click on the colour within the Colour Palette you want to select as the Primary Colour.
3. Right-click on the colour within the Colour Palette you want to select as the Secondary Colour.

4. Move the roller  over the bitmap image and click to flood fill it with the Primary Colour. The Primary Colour continues flooding an area until it meets pixels of the Secondary Colour.



---



**Note:** If colours are surrounded by the Secondary Colour they are not filled in the Primary Colour. You must flood fill these areas separately.

---

## Copying and Pasting Bitmap Areas

You can copy and paste a region within a bitmap image shown in the model area (the white area) using the Selection Rectangle tool.

To do so:

1. Click on the **Selection Rectangle** button  in the **File** toolbar.
2. Move the  cursor over a corner of the region of the bitmap image shown in the model area (the white area) that you want to copy, and then click and drag diagonally.

The selection rectangle appears in the **2D view** window as follows:



If you want to move the selection rectangle to another position in the model area:

- Move the cursor inside of the selection rectangle, and then click and drag it into position.

If you want to edit the size of the selection rectangle:

- Move the cursor over a corner or side of the selection rectangle, then click and drag to set its size.

3. Click on the **Copy** button  in the **File** area of the **Assistant's** Home page to copy the region of the bitmap image within the selection rectangle to the clipboard.



---

**Note:** You can also copy the region of the bitmap image within the selection rectangle by pressing the **Ctrl + C** keys on your keyboard, or by clicking on the **Edit** menu in the Main menu bar, followed the **Copy** option.

---

4. Click on the **Paste** button  in the **File** area of the **Assistant's** Home page to attach the copied bitmap region to the selection rectangle. The selection rectangle moves to the top left corner of the model area.



---

**Note:** You can also attach the copied bitmap region to the selection rectangle by pressing the **Ctrl + V** keys on your keyboard, or by clicking on the **Edit** menu in the Main menu bar, followed the **Paste** option.

---

5. Drag the selection rectangle to the position in the model area in which you want to paste the copied region of the bitmap image, and then click to paste.

---

## Converting a Bitmap into Vectors

You can convert any bitmap image into vector objects. ArtCAM Pro creates vector objects around the outline of all areas in the Primary Colour, together with those colours that are linked to the Primary Colour. For further details about colour linking, see "Colour Linking" on page 134.

When converting a bitmap image into vector objects, the resulting vector objects follow the pixellated outline of the bitmap. You can smooth the outline of these vector objects by replacing their linear spans with bezier curves. For details, see "Smoothing Vector Objects" in the Working with Vectors chapter.

To convert a bitmap image into vector objects:

1. Click on the colour within the Colour Palette that you want to select as the Primary Colour.

2. Click on the **Bitmap to Vector** button  in the **Vector – Bitmap** area of the **Assistant's Home** page to display the **Vectors From Bitmap** dialog box:

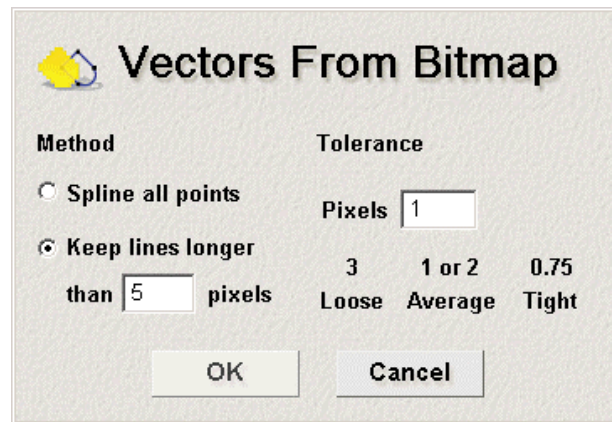

3. Click on the **Method** radio button  you want to use:
  - **Spline all points** - This option fits bezier curve spans between all points (nodes) in the vector objects.
  - **Keep lines longer than  pixels** - This option fits bezier curve spans between all points (nodes), except where the number of consecutive pixels you define in the box form a straight line.
4. In the **Tolerance** area, define the tolerance in the **Pixels** box. This sets how closely the bezier curve spans follow the points (nodes) within the vector objects.
5. Click on the **OK** button to close the **Vectors From Bitmap** dialog box and create the vector objects in the **2D View** window.

The **Working** box appears while ArtCAM Pro converts the bitmap image into vector objects:

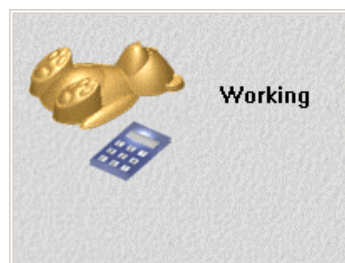

6. Click on the **Bitmap On/Off** button  in the **2D View** toolbar to hide the original bitmap image, allowing you to see the new vector objects clearly.

---

# Creating a Shape from a Bitmap

You can generate three-dimensional shapes from any colour within a bitmap image using the **Shape Editor** tool. For more details, see "Creating a Shape from a Bitmap" in the Working with Reliefs chapter.





# Working with Vectors

---

## Overview

A vector object, or object-oriented graphic, is made up of a sequence of commands or mathematical statements that places lines and shapes in a given two-dimensional or three-dimensional space. Vector objects are fully scalable without loss of resolution, and file sizes are independent of resolution.

In ArtCAM Pro, you can both import vector artwork from other applications and convert a bitmap image into vector objects. For details, see "Importing Vector Artwork" in the Working with Models chapter and "Converting a Bitmap into Vectors" in the Working with Bitmaps chapter.

Once you have created or opened a model file, you can use the drawing tools in the **Vector Editing** area of the **Assistant's** Home page and/or the **Vector** toolbar to create your own vector objects that can then be used to:

- Machine a 2D model. For details, see "2D Toolpath Strategies" in the Machining Models chapter.

Create a shape that can be used to machine a 3D model. For details, see "Creating a Shape from a Closed Vector" and "Creating a Shape Using Vectors" in the Working with Reliefs chapter, then "3D Toolpath Strategies" in the Machining Models chapter.

The group of vector drawing tools are found in the **Vector Editing** area of the **Assistant's** Home page and on the **Vector** toolbar:

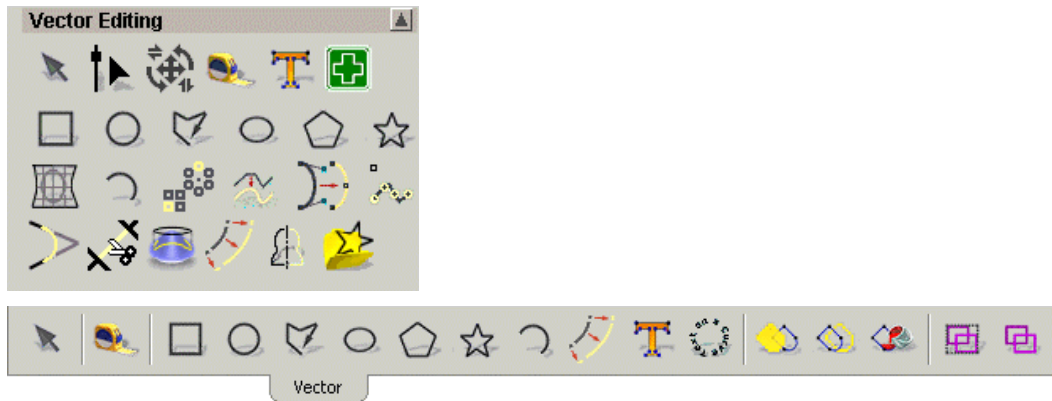

You can also find tools in the **Position Size Align Vectors** and **Group Merge Join Trim Vectors** areas of the **Assistant's** Home page, and on the **Vector Editing** and **Vector Merging** toolbars, that assist you in editing and manipulating the vector objects you create:

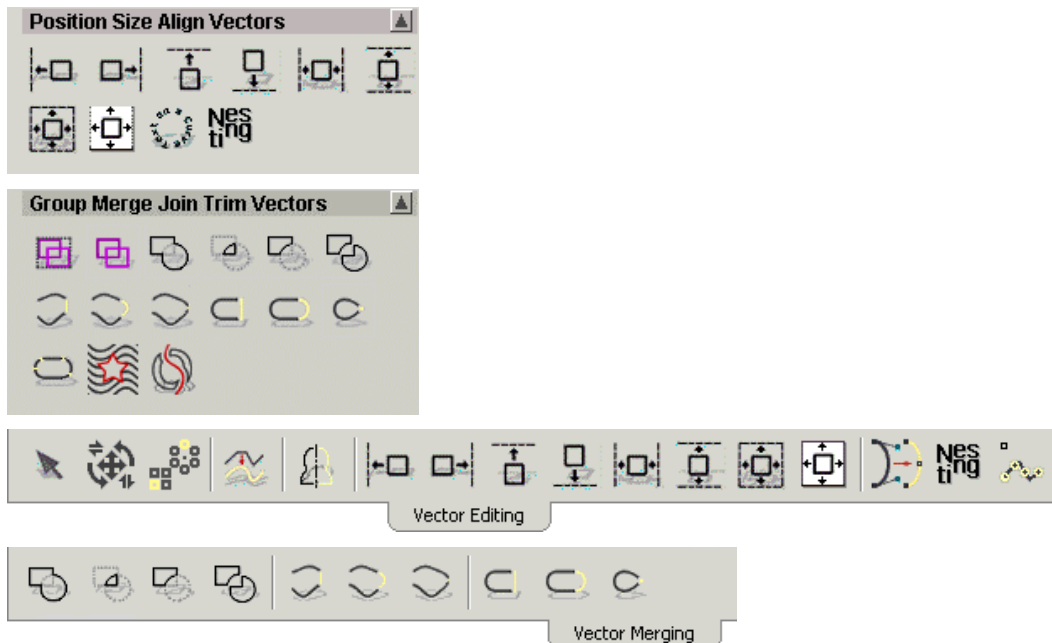

## Drawing with Polylines

You can create freeform vector objects from polylines, which are one or more linear or bezier curve spans joined together by points (nodes).

### Creating a Polyline

When creating a polyline, ArtCAM Pro displays the co-ordinates of the current cursor position, the angle and length of the span you are creating, the co-ordinates of the last point, and the change in position from the last point in both the X and Y direction on the **Polyline Creation** page.

To create a polyline:

1. Click on the **Create Polyline** button  in the **Vector Editing** area of the **Assistant's** Home page to display the **Polyline Creation** page.
2. Click once in the **2D View** window to create the start point (node) of the polyline.
3. Drag the mouse. A dotted line appears indicating where the polyline is to be drawn.



---

**Tip:** Click and hold the left button before dragging the mouse to create a bezier curve span. Release the mouse button to create the point (node) in the polyline.

---

4. Click at the position where you want to create another point (node) in the polyline.



---

**Tip:** Press and hold the **Ctrl** key on your keyboard during each click of the mouse to constrain the angle of the linear span drawn between points (nodes) to 15° increments.

---

A linear span is drawn connecting the two points (nodes). Repeat this and the previous step if you want to create further points (nodes) in the polyline connected by linear spans.

5. Right-click to end the polyline and return to the **Assistant's** Home page.



---

**Note:** You can also end the polyline if you press the **Esc** key on your keyboard or click on the **Close** button on the **Polyline Creation** page.

---

For example, if you click in the right of the **2D View** window, drag downwards and left, and then right-click, you can create a polyline that looks something like this:

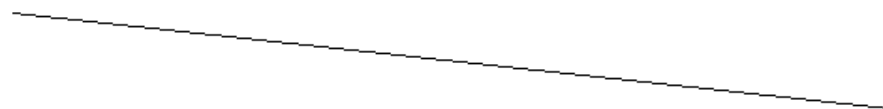

You can also create a polyline using co-ordinates taken from the **2D View** window:

1. Click on the **Create Polyline** button  in the **Vector Editing** area of the **Assistant's** Home page to display the **Polyline Creation** page.
2. Click on the position in the **2D View** window where you want to create the polyline's Start Point.
3. Define the position of the next point, using any of the following methods:



---

**Tip:** Move the cursor to the position where you want to create the point in the polyline. The X and Y co-ordinates for the position are shown in the **Cursor Position** area of the page.

---

- Define the X and Y co-ordinates for the next point in the **X** and **Y** boxes.
  - Define the angle of the next span in the polyline in the  $^{\circ}$  box, followed by its length in the **L** box.
  - Define the distance from the previous point in the X and Y axes in the **dx** and **dy** boxes.
4. If you want the polyline to be made up of bezier curve spans joined by smoothed points, rather than linear spans joined by points, click to select the **Draw Smooth Polylines** option . For further information, see "Editing Vector Spans" on page 175 and "Editing Vector Nodes" on page 182.
  5. Click on the **Add** button.
  6. Repeat these steps until you have finished creating the polyline, and then click on the **Close** button to return to the **Assistant's** Home page.

## Completing Polyline Creation

To complete the polyline you are drawing, but remain in polyline creation mode:

- Press the **Space Bar** on your keyboard.

To finish creating a polyline and return to the **Assistant's** Home page, leaving it as an open vector object, you can use any of the following methods:

- Right-click on your mouse.

- Press the **Esc** key on your keyboard.
- Press the **Return** key on your keyboard.
- Click on the **Close** button on the **Polyline Creation** page.

By default, the polyline is black, indicating that an ungrouped, open vector object has been created. If, however, you create a polyline on a layer to which a colour has been given, the polyline adopts the layer's colour. For further information, see "Selecting Vectors" on page 172 and "Assigning a Colour to a Layer" in the Working with Models chapter.

## Closing a Polyline to Create a Polygon

If you are in **Polyline Creation** mode, you can finish creating a polyline and automatically join its Start Point with its last point to form a polygon if you:

- Press the **Tab** key on your keyboard.

If you have already created a polyline, you can join its Start Point with its last point (node) to form a polygon if you:

1. Click to select the polyline that you have created. The polyline is magenta and surrounded by a bounding box. For details, see "Selecting Vectors" on page 172.
2. Click on the **Node Editing** button  in the **Vector Editing** area of the **Assistant's** Home page to enter Node Editing mode. The polyline turns black, and you can see the spans and points (nodes) that make up the polyline.
3. Click and drag the start point (green) to meet the last point in the polyline.

## Amending a Polyline

A polyline is made up of spans and points (nodes). Spans can be lines, arcs or bezier curves. You can change the position of the points and the nature of the spans after the polyline is created. For example, a linear span can be changed to an arc or a bezier curve span.

You change a polyline's form using both the Node Editing and Vector Editing menu options. These menus are displayed when working in Node Editing mode and right-clicking on either a span or a point. For details, see "Editing Vector Spans" on page 175 and "Editing Vector Nodes" on page 182.

---

# Creating Simple Shapes

In addition to the **Create Polyline** button , as detailed in "Creating a Polyline" on page 152, there are a further six buttons in the **Vector Editing** area of the **Assistant's** Home page that allow you to create specific vector object shapes.

You can create:

- Rectangles or Squares. See "Creating a Rectangle" on page 156.
- Circles. See "Creating a Circle" on page 159
- Ellipses. See "Creating an Ellipse" on page 161.
- Polygons. See "Creating a Polygon" on page 164.
- Stars. See "Creating a Star" on page 166.
- Arcs. See "Creating an Arc" on page 169.

## Creating a Rectangle



You can create either an exact or an approximate square or rectangular shaped vector object.

To create an exact square or rectangle:

1. Click on the **Create Rectangle** button  in the **Vector Editing** area of the **Assistant's** Home page to display the **Rectangle Creation** page.
2. Click on the **Square** or **Rectangle** radio button  to select the type of shape you want to create.
3. Define the height of the shape in the **Height** box.
4. Define the width of the shape in the **Width** box.
5. If you want filleted (rounded) corners, define the radius you want to apply to all four corners in the **Corner Radii** box. Otherwise, leave the default value of 0 in the **Corner Radii** box.
6. Define the centre point of your shape. To do so, you can either:
  - Define the X and Y co-ordinates of the centre point in the **Centre Point's X** and **Y** boxes.

- Move the  $+$  cursor over the **2D View** window and click on the position that you want to set as the centre point. The X and Y co-ordinates of the point appear in the **Centre Point's X** and **Y** boxes.
7. If you want your shape to be drawn at a specific angle to the model block, define the angle in the **Angle** box:
    - Type a positive angle to rotate the shape clockwise.
    - Type a negative angle to rotate the shape anti-clockwise.
  8. Click on the **Preview** button to see the shape you are about to create in the **2D View** window.
  9. If you want to draw your shape and remain in Rectangle Creation mode, click on the **Create** button. If you want to draw your shape and return to the **Assistant's** Home page, right-click.

To create an approximate sized square or rectangle:

1. Click on the **Create Rectangle** button  in the **Vector Editing** area of the **Assistant's** Home page to display the **Rectangle Creation** page.
2. Click on the **Square** or **Rectangle** radio button  to select the type of shape you want to create.
3. Move the  $+$  cursor over the **2D View** window, and then click and drag to create the size of shape you want.
4. Release the mouse button to draw a preview image of the shape you are creating in the **2D View** window.
5. If you want to draw your shape and remain in Rectangle Creation mode, click on the **Create** button. If you want to draw your shape and return to the **Assistant's** Home page, right-click.

## ***Editing a Square or Rectangle***

You can edit the size, position, corners and/or angle of a square or rectangular shaped vector object.

To begin editing a square or rectangle:

1. Select the square or rectangle you want to edit. For details, see "Selecting Vectors" on page 172.

2. Right-click on the selected shape to display the Vector Editing menu.
3. Click on the **Edit Rectangle** option to display the **Rectangle Editing** page in the **Assistant** window.

The selected shape now appears with resizing handles attached to it, and a rotation handle attached to its centre point:

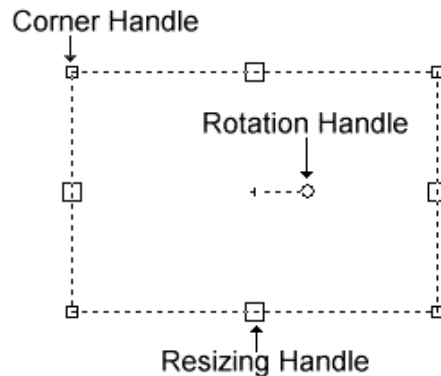

---

**Note:** You can display the **Rectangle Editing** page by selecting a square or rectangle, and then pressing the **E** key on your keyboard.

---

You can now change the size, position, corners and/or angle of the selected square or rectangle using the **Rectangle Editing** page, or by manipulating the handles on the shape itself.

To edit the selected square or rectangle using the **Rectangle Editing** page:

- Define a new value in the appropriate box for each attribute of the shape that you want to adjust.

For example, typing a new value in the **Height** box immediately increases or decreases the height of the selected square or rectangle.

You can edit the selected square or rectangle using the shape itself:

- Click and drag any of the resizing handles to adjust the size of the shape. The new height and width is shown in the **Height** and **Width** boxes on the **Rectangle Editing** page.
- Click and drag any of the corner handles to add filleting to all four corners of the shape. The new radius of the filleted corners is shown in the **Corner Radii** box on the **Rectangle Editing** page.



- Click and drag the rotation handle to adjust the angle of the shape. The new angle is shown in the **Angle** box on the **Rectangle Editing** page.
- Move the **+** cursor over the centre point of the shape. When it changes to the **↕** cursor, click and drag to move the whole shape. The new centre point appears in the **Centre Point's X** and **Y** boxes on the **Rectangle Editing** page.



---

**Tip:** To create an exact square, hold down the **Shift** key down on your keyboard, and then drag the resizing handles on your rectangle to the required size.



---

To confirm the new shape shown in the **2D View** window and return to the **Assistant's** Home page, right-click.

## Creating a Circle

You can create a circular shaped vector object.

To create a circle of a specified size:

1. Click on the **Create Circles** button  in the **Vector Editing** area of the **Assistant's** Home page to display the **Circle Creation** page.
2. Define the centre point of the circle. To do so, you can either:
  - Define the X and Y co-ordinates of the centre point in the **Circle Centre's X** and **Y** boxes.
  - Move the **+** cursor over the **2D View** window and click on the position you want to set as the centre point. The X and Y co-ordinates of the point are shown in the **Circle Centre's X** and **Y** boxes.
3. In the **Circle Size** area, define the size of the circle. You can:
  - Click to select the **Radius** radio button , and then define the circle's radius in the box below; or
  - Click to select the **Diameter** radio button , and then define the circle's diameter in the box below.
4. If you want the circle to be made up of four arc spans, rather than four bezier curve spans, click to select the **Create**

**with Arcs** option . For further information, see "Editing Vector Spans" on page 175 and "Editing Vector Nodes" on page 182.

5. Click on the **Preview** button to draw a preview image of the circle you are creating in the **2D View** window.
6. If you want to draw the circle and remain in **Circle Creation** mode, click on the **Create** button. If you want to draw your circle and return to the **Assistant's** Home page, right-click.

To create an approximate sized circle:

1. Move the **+** cursor over the **2D View** window, and then click and drag to create the size of circle you want.
2. Release the mouse button to draw a preview image of the circle you are creating in the **2D View** window.
3. If you want to draw your circle and remain in Circle Creation mode, click on the **Create** button. If you want to draw your circle and return to the **Assistant's** Home page, right-click.

## ***Editing a Circle***

You can edit the radius and position of a circular shaped vector object.

To edit a circle:

1. Select the circle you want to edit. For details, see "Selecting Vectors" on page 172.
2. Right-click on the circle to display the Vector Editing menu.
3. Click on the **Edit Circle** option to display the **Circle Editing** page in the **Assistant** window.

The selected circle now appears as a preview image with a resizing handle:

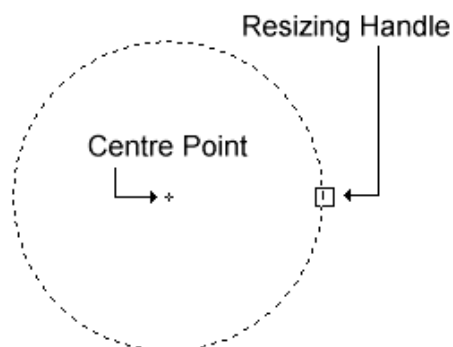

You can now change the size and position of the selected circle using the **Circle Editing** page, or by manipulating the resizing handle and the centre point on the shape itself.



---

**Note:** You can display the **Circle Editing** page by selecting a circle, and then pressing the **E** key on your keyboard.

---

To edit the selected circle using the **Circle Editing** page:

- Define a new value in the appropriate box for either of the shape's attributes that you want to adjust.

For example, typing a new value in the **Radius** box immediately increases or decreases the size of the selected circle.

You can edit the selected circle using the shape itself:

- Click and drag the resizing handle to adjust its radius. The new radius is shown in the **Radius** box on the **Circle Editing** page.
- Move the  $+$  cursor over the centre point of the circle. When it changes to the  $\leftrightarrow$  cursor, click and drag to move the circle. The new centre point is shown in the **Centre Point's X** and **Y** boxes on the page.

To confirm the new circle shown in the **2D View** window and return to the **Assistant's** Home page, right-click.

## Creating an Ellipse

You can create an elliptical shaped vector object.

To create an ellipse of a specified size:

1. Click on the **Create Ellipse** button  in the **Vector Editing** area of the **Assistant's** Home page to display the **Ellipse Creation** page.
2. Define the centre point of your ellipse. To do so, you can either:
  - Define the X and Y co-ordinates of the centre point in the **Start Point's X** and **Y** boxes.
  - Move the  $+$  cursor over the **2D View** window and then click on the point. The X and Y co-ordinates of

the point are shown in the **Start Point's X** and **Y** boxes.

3. Define the height of the ellipse in the **Ellipse Height** box.
4. Define the width of the ellipse in the **Ellipse Width** box.
5. If you want your shape to be drawn at a specific angle to the model block, define the angle in the **Angle** box:
6. Click on the **Preview** button to see the ellipse you are about to create in the **2D View** window.
7. If you want to draw your ellipse and remain in Ellipse Creation mode, click on the **Create** button. If you want to draw your ellipse and return to the **Assistant's** Home page, right-click..

To create an approximate sized ellipse:

1. Move the **+** cursor over the **2D View** window, and then click and drag to create the size of ellipse you want.
2. Release the mouse button to draw a preview image of the ellipse you are creating in the **2D View** window.
3. If you want to draw your ellipse and remain in Ellipse Creation mode, click on the **Create** button. If you want to draw your ellipse and return to the **Assistant's** Home page, right-click.

## ***Editing an Ellipse***

You can edit the size, position and/or angle of an elliptical shaped vector object.

To edit an ellipse:

1. Select the ellipse you want to edit. For details, see "Selecting Vectors" on page 172.
2. Right-click on the selected ellipse to display the Vector Editing menu.
3. Click on the **Edit Ellipse** option to display the **Ellipse Editing** page in the **Assistant** window.

The selected ellipse now appears as a preview image with resizing handles attached to it, and a rotation handle about its centre point:

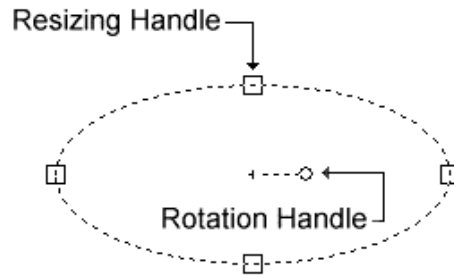

---

**Note:** You can display the **Ellipse Editing** page by selecting an ellipse, and then pressing the **E** key on your keyboard.

---

You can now change the size, position and/or angle of the selected ellipse using the **Ellipse Editing** page, or by manipulating the handles on the ellipse itself.

To edit the selected ellipse using the **Ellipse Editing** page:

- Type a new value in the appropriate box for each attribute of the ellipse that you want to adjust.

For example, typing a new value in the **Height** box immediately increases or decreases the height of the ellipse.

You can edit the selected ellipse using the shape itself:

- Click and drag any of the resizing handles to adjust the size of the ellipse. The new height and width is shown in the **Height** and **Width** boxes on the **Ellipse Editing** page.
- Click and drag the rotation handle to adjust the angle of the ellipse. The new angle is shown in the **Angle** box on the **Ellipse Editing** page.
- Move the **+** cursor over the centre point of the ellipse. When it changes to the **↕** cursor, click and drag to move the whole ellipse. The new centre point is shown in the **Start Point's X** and **Y** boxes on the **Ellipse Editing** page.

To confirm the new ellipse shown in the **2D View** window and return to the **Assistant's** Home page, you can either:

- Click on the **Apply** button, followed by the **Close** button on the **Ellipse Editing** page.
- Click the right mouse button.

## Creating a Polygon

You can create a vast range of polygonal shaped vector objects.

To create an exact polygon:

1. Click on the **Create Polygons** button  in the **Vector Editing** area of the **Assistant's** Home page to display the **Polygon Creation** page.
2. Define the polygon's number of sides in the **Settings' No. of Sides** box.



---

**Warning:** A polygon must have a minimum of three sides. Typing 3 in the **Settings' No. of Sides** box produces a triangle.

---

3. If you want your polygon to be drawn at a specific angle to the model block, define the angle in the **Settings' Angle** box:
  - Type a positive angle in the **Angle** box to rotate the polygon clockwise.
  - Type a negative angle in the **Angle** box to rotate the polygon anti-clockwise.
4. Define the centre point of your polygon. To do so, you can either:
  - Define the X and Y co-ordinates of the centre point in the **Polygon Centre's X** and **Y** boxes.
  - Move the + cursor to the point in the model you are interested in and then click. The X and Y co-ordinates of the point you click on appear in the **Polygon Centre's X** and **Y** boxes.
5. Define the polygon's radius in the **Geometry's Radius** box.
6. Click on the **Preview** button to see the polygon you are about to create in the **2D View** window.
7. If you want to draw your polygon and remain in Polygon Creation mode, click on the **Create** button. If you want to draw your polygon and return to the **Assistant's** Home page, right-click.

To create an approximate sized polygon:

1. Move the  $\oplus$  cursor over the **2D View** window, and then click and drag to create the size of polygon you want.
2. Release the mouse button to draw a preview image of the polygon you are creating in the **2D View** window.
3. If you want to draw your polygon and remain in Polygon Creation mode, click on the **Create** button. If you want to draw your polygon and return to the **Assistant's** Home page, right-click.

## ***Editing a Polygon***

You can edit the size, position, sides and/or angle of a polygonal shaped vector object.

To edit a polygon:

1. Select the polygon you want to edit. For details, see "Selecting Vectors" on page 172.
2. Right-click on the polygon to display the Vector Editing menu.
3. Click on the **Edit Polygon** option to display the **Polygon Editing** page in the **Assistant** window.

The polygon now appears as a preview image with resizing handles and a rotation handle:

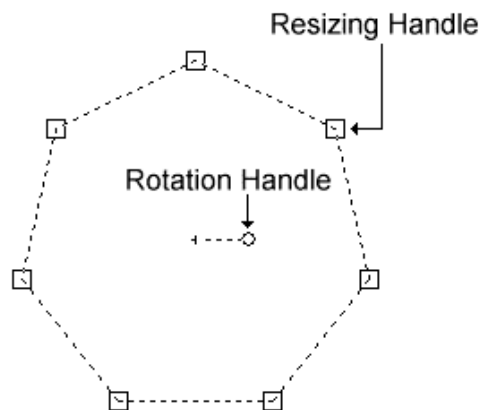

You can now change the size, position, sides and/or the angle of the selected polygon using the **Polygon Editing** page, or by manipulating the handles on the polygon itself.

To edit the selected polygon using the **Polygon Editing** page:

- Type a new value in the appropriate box for each attribute of the polygon that you want to adjust.

For example, typing a new value in the **No. of Sides** box immediately increases or decreases the number of sides in the selected polygon.

You can edit the selected polygon using the shape itself:

- Click and drag any of the resizing handles to adjust the size of the polygon. The new size is shown in the **Geometry's Radius** box on the **Polygon Editing** page.
- Click and drag the rotation handle to adjust the angle of the polygon. The new angle is shown in the **Angle** box on the **Rectangle Editing** page.
- Move the **+** cursor over the centre point of the polygon. When it changes to the **↕** cursor, click and drag to move the whole polygon. The new centre point is shown in the **Polygon Centre's X** and **Y** boxes on the **Polygon Editing** page.

To confirm the new polygon shown in the **2D View** window and return to the **Assistant's** Home page, you can either:

- Click on the **Apply** button, followed by the **Close** button on the **Polygon Editing** page.
- Click the right mouse button.

## Creating a Star

You can create a star shaped vector object.

To create an exact star:

1. Click on the **Create Stars** button  in the **Vector Editing** area of the **Assistant's** Home page to display the **Star Creation** page.
2. Define the polygon's number of sides in the **Settings' No. of Points** box.
3. If you want your star to be drawn at a specific angle to the model block, define the angle in the **Settings' Angle** box:
  - Type a positive angle in the **Angle** box to rotate the star clockwise.
  - Type a negative angle in the **Angle** box to rotate the star anti-clockwise.



4. Define the centre point of your star. To do so, you can either:
  - Define the X and Y co-ordinates of the centre point in the **Star Centre's X** and **Y** boxes.
  - Move the + cursor over the **2D View** window and click on the position you want to set as the centre point. The X and Y co-ordinates of the point are shown in the **Star Centre's X** and **Y** boxes.
5. In the **Geometry's Radius of first Points** box, define the radius of the polygon, upon which the outer points (nodes) in the star lie.
6. In the **Geometry's Radius of second Points** box, define the radius of the polygon, upon which the inner points (nodes) in the star lie.
7. Click on the **Preview** button to see the ellipse you are about to create in the **2D View** window.
8. If you want to draw your star and remain in Star Creation mode, click on the **Create** button. If you want to draw your star and return to the **Assistant's** Home page, right-click.

To create an approximate sized star:

1. Move the + cursor over the **2D View** window, and then click and drag to create the size of polygon you want, upon which the outer points in the star lie.
2. Click and drag to create the size of polygon you want, upon which the inner points in the star lie.
3. Release the mouse button to draw a preview image of the star you are creating in the **2D View** window.
4. If you want to draw your star and remain in Star Creation mode, click on the **Create** button. If you want to draw your polygon and return to the **Assistant's** Home page, right-click.

## ***Editing a Star***

You can edit the size, position, sides and/or angle of a star shaped vector object.

To edit a star:

1. Select the star you want to edit. For details, see "Selecting Vectors" on page 172.

2. Right-click on the star to display the Vector Editing menu
3. Click on the **Edit Star** option to display the **Star Editing** page in the **Assistant** window.



---

**Note:** You can display the **Star Editing** page in the **Assistant** window by pressing the **E** key on your keyboard.

---

The star now appears as a preview image with resizing handles attached to it, and a rotation handle about its centre point:

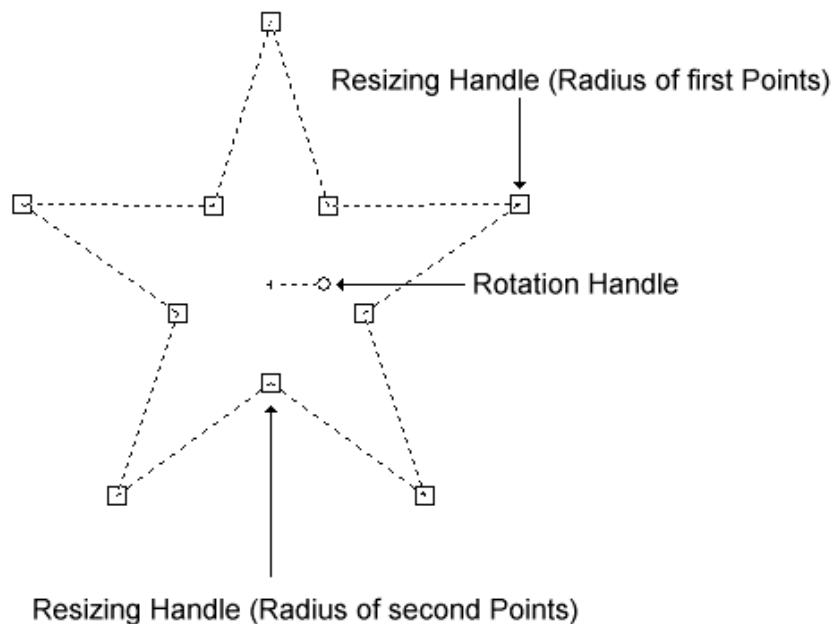

You can now change the size, position, sides and/or the angle of the selected star using the **Star Editing** page, or by manipulating the handles on the star itself.

To edit the selected star using the **Star Editing** page:

- Type a new value in the appropriate box for each attribute of the star that you want to adjust.

For example, typing a new value in the **No. of Sides** box immediately increases or decreases the number of sides in the selected star.

You can edit the selected star using the shape itself:

- Click and drag any of the inner or outer resizing handles to adjust the size and shape of the star. The new size is shown in the **Geometry's Radius of first Points** and/or

**Radius of second Points** boxes on the **Star Editing** page.

- Click and drag the rotation handle to adjust the angle of the star. The new angle is shown in the **Angle** box on the **Rectangle Editing** page.
- Move the **+** cursor over the centre point of the star. When it changes to the **↕** cursor, then click and drag to move the whole star. The new centre point appears in the **Star Centre's X** and **Y** boxes on the **Star Editing** page.



To confirm the new star shown in the **2D View** window and return to the **Assistant's** Home page, you can either:

- Click on the **Apply** button, followed by the **Close** button on the **Star Editing** page.
- Click the right mouse button.

## Creating an Arc

You can create an arc shaped vector object.

To create an arc:

1. Click on the **Create Arcs** button  in the **Vector Editing** area of the **Assistant's** Home page to display the **Arc Creation** page.
2. Click on either of the **Arc Type** radio buttons  to select the type of arc you want to create:
  - **Centre – Start – End** – A swept arc created by defining a centre point, a Start Point and then an end point.
  - **Start – End – Point On Arc** – A fitted arc created by defining a Start Point, an end point and then a mid point.
  - **Start – End – Radius** – A swept arc created by defining a Start Point, a end point and then a radius.
3. If you have selected the **Centre – Start – End** option:
  - Move the **+** cursor over the **2D View** window and click on the position that you want to set as the arc's centre point. The X and Y co-ordinates of the point are shown in the **Centre Point** area of the page.

- Move the  $\oplus$  cursor over the **2D View** window and then click on the position that you want to set as the arc's start point. The X and Y co-ordinates of the point are shown in the **Start Point** area of the page.
- Move the  $\oplus$  cursor over the **2D View** window and click on the position that you want to set as the arc's end point. The X and Y co-ordinates of the point are shown in the **End Point** area of the page.

If you have selected the **Start – End – Point On Arc** option:

- Move the  $\oplus$  cursor over the **2D View** window and then click on the position that you want to set as the arc's start point. The X and Y co-ordinates of the point are shown in the **Start Point** area of the page.
- Move the  $\oplus$  cursor over the **2D View** window and click on the position that you want to set as the arc's end point. The X and Y co-ordinates of the point are shown in the **End Point** area of the page.
- Move the  $\oplus$  cursor over the **2D View** window and click on the position that you want to set as the arc's mid point. The X and Y co-ordinates of the point are shown in the **Centre Point** area of the page.

If you have selected the **Start – End – Radius** option:

- Define the direction of the arc. If you want to draw the arc in a clockwise direction from its Start Point, make sure that the **Clockwise** option is selected .
  - Define the radius of the arc in the **Radius** box.
  - Move the  $\oplus$  cursor over the model area and click on the position that you want to set as the arcs Start Point. The X and Y co-ordinates of the point are displayed in the **Start Point** area of the page.
  - Move the  $\oplus$  cursor over the model area and click on the position that you want to set as the arc's end point. The X and Y co-ordinates of the point are displayed in the **End Point** area of the page.
4. Rather than clicking on your mouse to set the position of specific points in the arc, you can also specify their exact

co-ordinates. What points you can define in the arc depends on which type of arc you are actually creating:

- If you want to change the position of the centre point, define the co-ordinates of its new position in the **X** and **Y** boxes in the **Edit Centre Point** area.
  - If you want to change the position of the Start Point, define the co-ordinates of its new position in the **X** and **Y** boxes in the **Edit Start Point** area.
  - If you want to change the position of the end point, define the co-ordinates of its new position in the **X** and **Y** boxes in the **Edit End Point** area.
  - If you want to change the radius of the arc, define its new radius in the **Radius** box.
5. Click on the **Preview** button to see the arc you are about to create in the **2D View** window.
  6. If you want to draw your arc and remain in Arc Creation mode, click on the **Create** button. If you want to draw your arc and return to the **Assistant's** Home page, right-click on your mouse.

---

## Editing Vector Objects

You can edit any of the standard shapes of vector object in a model in the same way: square, rectangle, circle, ellipse, polygon and star.

To edit any of these standard shapes, select the vector object, then either:

- Press the **E** key on your keyboard.
- Right-click to display the Vector Editing menu and then click on the **Edit** option for the selected vector object e.g. **Edit Ellipse**.

ArtCAM Pro displays the Editing page for the selected vector object in the **Assistant** e.g. **Ellipse Editing**. You are then able to change the properties for the selected shape of vector object by modifying the appropriate values. For example, the **Height** of a rectangle.

You cannot edit the following vector objects using an Editing page in the **Assistant**, although they still can be edited:

- Created with the **Polyline Creation** tool. For details, see "Creating a Polyline" on page 152.

- Created with the **Arc Creation** tool. For details, see "Creating an Arc" on page 169.
- Created with one of the buttons in the **Vector Editing** area of the **Assistant's** page, and in which you have moved or edited a point (node) or span. For details, see "Editing Vector Objects" on page 171.
- Imported directly into ArtCAM Pro. For details, see "Importing Vector Artwork" in the Working with Models chapter.
- Created from a bitmap image using the **Bitmap to Vector** tool. For details, see "Converting a Bitmap into Vectors" in the Working with Bitmaps chapter.

## Selecting Vectors

You can select vector objects from any of the visible layers in a model. For further information on layers, see "Viewing a Layer" in the Working with Models chapter.

To select a single vector object from a layer:

1. Click on the **Select Vectors** button  in the **Vector Editing** area, and then on the vector object that you want to select.



---

**Note:** If the **Select Vectors** button is shown as  in the **Vector Editing** area, you are already in Select Vectors mode.

---



---

**Note:** You can also press the **Esc** key to enter Select Vectors mode, or right-click to display the Vector Editing menu, and then click on the **Select Vectors Mode** option.

---





---

**Note:** You can also use the **N** key to toggle between the different modes. For example, pressing the **N** key once when in Transform Vectors mode takes you into Node Editing mode. Pressing it twice takes you into Select Vectors mode.

---

To select more than one vector object from any visible layer:

1. Click on the **Select Vectors** button  in the **Vector Editing** area, and then on the vector object that you want to select.
2. Hold the **Shift** key down on your keyboard, and then click on each of the vector objects you want to select.



---

**Note:** You can also click and drag around any number of vector objects to select them. A bounding box surrounds all selected vector objects.

---



---

**Tip:** To deselect a vector object you have selected by mistake, hold the **Shift** key down on your keyboard and then click.

---

Vector objects are not always shown in the colour assigned to the layer from which they have been selected:



---

**Note:** You can set the default colour for selected vector objects using the **ArtCAM Options** page. For details, see "Managing ArtCAM Pro's Preferences" in the ArtCAM Pro Layout chapter.

---

- By default, one or more ungrouped vector objects are magenta when selected. When deselected, they appear in the colour assigned to the layer on which they are drawn.

You can change the default colour used to indicate single and multiple ungrouped vector objects when selected using the **ArtCAM Options** page. For details, see "Managing ArtCAM Pro's Preferences" in the ArtCAM Pro Layout chapter.

- By default, all grouped closed vector objects are purple when selected, unless they are self-intersecting. Then they are shown in red with the  icon marking the position of all intersections. When deselected, all grouped closed vector objects appear in the colour assigned to the layer on which they are drawn, again unless they are self-intersecting. Then they are shown in red.

You can change the default colour used to indicate grouped vector objects when selected using the **ArtCAM Options** page. For details, see "Managing ArtCAM Pro's Preferences" in the ArtCAM Pro Layout chapter.

- By default, any locked vector object is grey when selected. When deselected it is green, regardless of the colour assigned to the layer on which it is drawn.

You can change the default colours used to indicate locked vector objects when selected and deselected using the **ArtCAM Options** page. For details, see "Managing ArtCAM Pro's Preferences" in the ArtCAM Pro Layout chapter.

- A grouped open vector object is blue when deselected, regardless of the colour assigned to the layer on which it is drawn.
- If you click and drag to around a vector object to select it, and it has one or more overlaying copies, the vector object turns red.

You can change the default colour used to indicate overlaying vector objects using the **ArtCAM Options** page. For details, see "Managing ArtCAM Pro's Preferences" in the ArtCAM Pro Layout chapter.

## Moving Vectors

You can move part or the whole of any selected vector object to another area of the layer, or to a different layer in a model. For further details, see "Transferring Vectors Between Layers" in the Working with Models chapter.





---

**Note:** You cannot move a vector object if it is locked. For details, see "Locking and Unlocking Vector Objects" on page 211 and "Locking the Vectors on a Layer" in the Working with Models chapter.

---

To move a vector object to another position in the current layer:

1. Select the vector object that you want to move. For details, see "Selecting Vectors" on page 172.
2. Move the cursor over the bounding box. The cursor changes from  to .
3. Click and drag the vector object into its new position, and then release the mouse button.

To transfer a vector object from one layer to another:

1. Select the vector object that you want to transfer to another layer. For details, see "Selecting Vectors" on page 172.



2. Right-click on the selected vector object to display the Vector Editing menu, and then click on the **Move To Layer** option to display the list of layers in the model.
3. Click to select the layer from those listed to which you want to transfer the selected vector object. The selected vector object is transferred to the layer and is now shown in the colour assigned to it.

Alternatively, you can transfer a vector object from one layer to another in the following way:

1. Click on the **Layers** tab  to display the **Layers** page.
2. Select the vector object that you want to transfer to another layer. For details, see "Selecting Vectors" on page 172.



---

**Tip:** If you want to transfer all of the vector objects in the currently selected layer, click on the **Select All** button.

---

3. In the list box at the bottom of the **Layers** page, click on the layer to which you want to transfer the selected vector object. The selected vector object is transferred to the chosen layer and are shown in the colour assigned to it.

## Editing Vector Spans

Spans within a vector object can be linear, arc or a bezier curve. You can change the type of span using the Vector Editing options, displayed when you right-click on a selected vector object.



The Vector Editing options allow you to:

- Convert a span to a line. For details, see "Converting a Span to a Line" on page 176.
- Convert a span to a bezier curve. For details, see "Converting a Span to a Bezier Curve" on page 177.
- Convert a span to an arc. For details, see "Converting a Span to an Arc" on page 178.
- Insert a point (node) into a span. For details, see "Inserting a Point" on page 179.
- Remove a span. For details, see "Removing a Span" on page 181.

## Converting a Span to a Line

Converting a span to a line allows you to alter the appearance of an arc or a bezier curve span within a vector object.

To convert a span to a line:

1. Make sure that you are in Node Editing mode . For details, see "Editing Vector Nodes" on page 182.
2. Click to select a vector object containing an arc or bezier curve span. A bounding box surrounds it, within which you can see the spans, points (nodes) and control points that make up the selected vector object.
3. Position the cursor over the arc or bezier curve span. When the cursor changes from  to , right-click to display the Vector Editing menu.
4. Click on the **Convert span to a line** option to convert the existing span into a linear span.



---

**Note:** Moving the cursor over the arc or bezier curve span and pressing the **L** key on your keyboard also converts it to a linear span.

---

For example, if you were to convert a bezier curve span to a linear span you would see that its adjoining control points have been removed along with any curvature, as shown below:

*Before...*

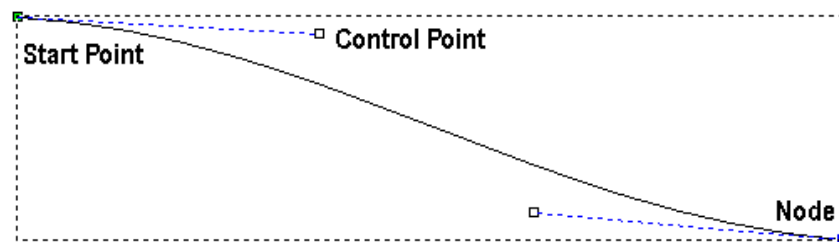

*After...*

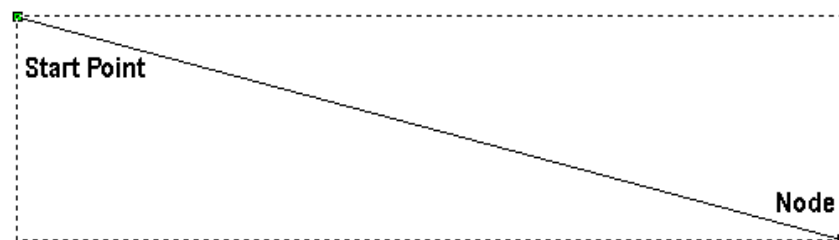



## Converting a Span to a Bezier Curve

Converting a span to a bezier curve allows you to alter the appearance of a linear or an arc span within a vector object.

Converting a span to a bezier curve places two control points on the span, both of which can be dragged to add or reduce the curvature within it.

To convert a span into a bezier curve:

1. Make sure that you are in Node Editing mode . For details, see "Editing Vector Nodes" on page 182.
2. Click to select a vector object containing an arc or linear span. A bounding box surrounds it, within which you can see the spans, points (nodes) and control points that make up the selected vector object.
3. Position the cursor over the arc or linear span. When the cursor changes from  to , right-click to display the Vector Editing menu.
4. Click on the **Convert span to bezier** option to convert the existing span into a bezier curve span.



---

**Note:** Moving the cursor over the linear or arc span and pressing the **B** key on your keyboard also converts it to a bezier curve.

---

For example, your span may look something like that shown below:

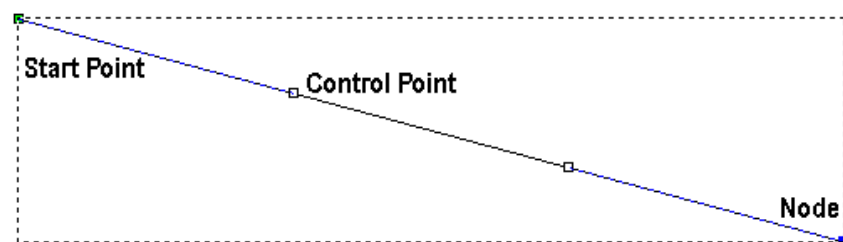

Although this span may not look like a curve now, the two control points in it indicate that it is a bezier curve span.

In our example, by dragging the control points as shown below, a bezier curve span with a smooth curvature is produced:

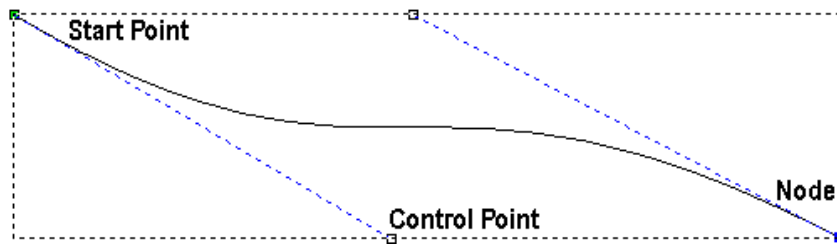



## Converting a Span to an Arc

Converting a span to an arc allows you to alter the appearance of a linear or bezier curve span within a vector object.

Converting a span to an arc places one control point in the middle of the span. This can be dragged to add or reduce the degree of curvature in the arc.

To convert a span into an arc:

1. Make sure that you are in Node Editing mode . For details, see "Editing Vector Nodes" on page 182.
2. Click to select a vector object containing an bezier curve or linear span. A bounding box surrounds it, within which you can see the spans, points (nodes) and control points that make up the selected vector object.
3. Position the cursor over the bezier curve or linear span. When the cursor changes from  to , right-click to display the Vector Editing menu.
4. Click on the **Convert span to arc** option to convert the existing span into an arc span.





---

**Note:** Moving the cursor over the linear or bezier curve span and pressing the **A** key on your keyboard also converts it to an arc.

---

For example, if you were to convert a linear span to an arc span you would see that one control point is now positioned in the centre of the arc. You can drag the control point to create a curve, as shown below:

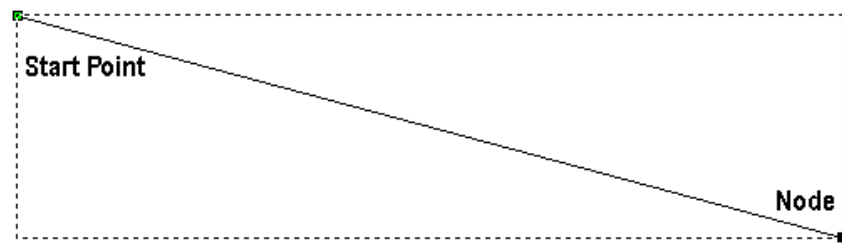
*Before...*



*After...*

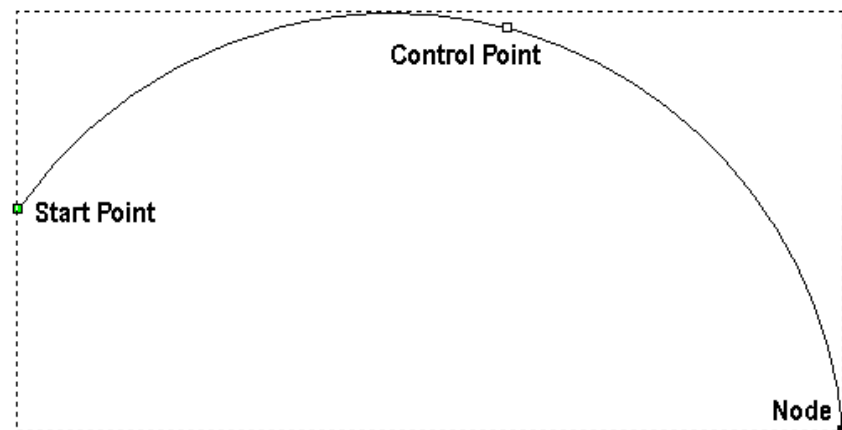



## ***Inserting a Point***

You can insert a point (node) in any span. Inserting a point divides a span into two new spans of the same type as the original.

By inserting a point you add greater flexibility in changing the shape of the vector object.

To insert a point in a span:

1. Make sure that you are in Node Editing mode . For details, see "Editing Vector Nodes" on page 182.
2. Click to select the vector object into which you want to insert a point. A bounding box surrounds it, within which you can see the spans, points (nodes) and control points that make up the selected vector object.
3. Position the cursor over the span into which you want to insert a point. When the cursor changes from  to , right-click to display the Vector Editing menu.
4. Click on the **Insert a point** option to produce a new point in the span, dividing it into two separate spans.



---

**Note:** Moving the cursor over the span and pressing the **I** key on your keyboard also inserts a point into it.

---

For example, a point has been inserted into the bezier curve span illustrated below. You can see that doing so has created a second bezier curve span with two adjoining control points:

*Before...*

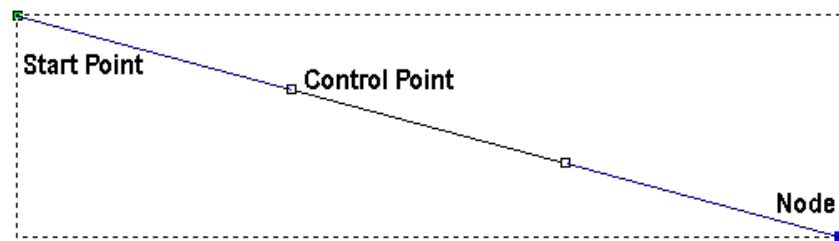

*After...*

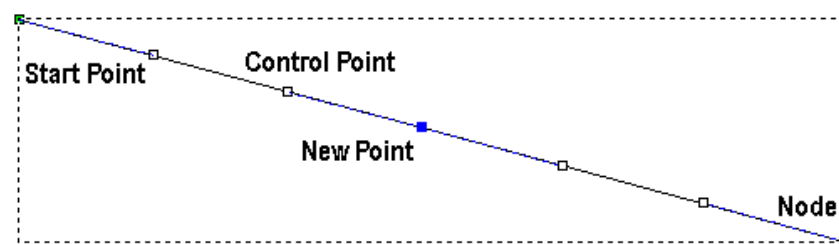

---

**Tip:** Adding points to a vector object can be a time consuming process. Alternatively, you can use the **Create Polyline** tool to create more complicated shapes from the beginning. With the **Create Polyline** page displayed, each corresponding movement and click of the mouse creates a new point and connects it to the last with a linear or bezier curve span. For details, see "Creating a Polyline" on page 152.

---

## ***Inserting a Start Point***

The green point shown within a selected vector object is the Start Point.

The Start Point in a vector object determines the point at which a tool enters the block of material when you are machining. For further details, see "Changing the Start Point Position" in the Machining Models chapter.

Inserting a Start Point divides a span into two new spans of the same type as the original. Alternatively, you can set an existing point (node) in a span as the Start Point. For details, see "Changing the Start Point" on page 189.





---

**Note:** For open vector objects, the Start Point must be at either end.

---

To insert a Start Point in a span:

1. Make sure that you are in Node Editing mode . For details, see "Editing Vector Nodes" on page 182
2. Click to select the vector object into which you want to insert a Start Point. A bounding box surrounds it, within which you can see the spans, points (nodes) and control points that make up the selected vector object.
3. Position the cursor over the span into which you want to insert a Start Point. When the cursor changes from  to , right-click to display the Vector Editing menu.
4. Click on the **Insert Start Point** option to produce a new Start Point in the span and divide it into two separate spans.



---



**Note:** Moving the cursor over the span and pressing the **P** key on your keyboard also inserts a Start Point into it.

---

## ***Removing a Span***

You can remove a linear, bezier curve or an arc span within any selected vector object in the same way.

To remove a span:

1. Make sure that you are in Node Editing mode . For details, see "Editing Vector Nodes" on page 182.
2. Click to select the vector object from which you want to remove a span. A bounding box surrounds it, within which you can see the spans, points (nodes) and control points that make up the selected vector object.
3. Position the cursor over the span. When the cursor changes from  to , right-click to display the Vector Editing menu.
4. Click on the **Remove Span** option to remove the selected span.



---

**Note:** Moving the cursor over the span and pressing the **R** key on your keyboard also removes it.

---

For example, a vector object with two spans appears as follows:

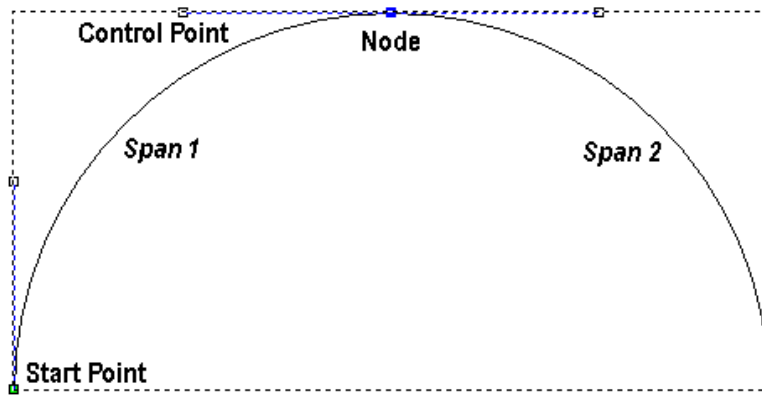

In our example, if you move the cursor over *Span 2* and then remove it from the vector object, the remaining span is shown below:

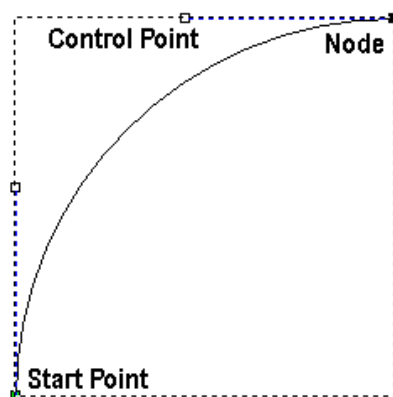

## Editing Vector Nodes

You can change the structure and appearance of a vector object using the Node Editing options, which are displayed when you are working in Node Editing mode and right-click on any point (node) within a selected vector object.

Working in Node Editing mode allows you to:

- Select points (nodes) and control points. For details, see "Selecting Points and Control Points" on page 183.
- Move points (nodes) and control points. For details, see "Moving Points" on page 184.
- Smooth points (nodes). For details, see "Smoothing Points" on page 185.
- Delete points (nodes). For details, see "Deleting Points" on page 187.
- Change the position of the start point. For details, see "Changing the Start Point" on page 189.



- Change the position of points (nodes) and/or control points. For details, see "Changing the Position of Points" on page 189.
- Align points (nodes). For details, see "Aligning Points" on page 190.

To edit points within a vector object, you must work in Node Editing mode. Use any of the following methods to enter Node Editing mode:





---

**Note:** If the **Node Editing** button is shown as  in the **Vector Editing** area, you are already in Node Editing mode.

---

- Click on the **Node Editing** button  in the **Vector Editing** area of the **Assistant's** Home page.
- Press the **N** key on your keyboard.
- Hold the **Ctrl** key down on your keyboard, and then click once.

The **Node Editing** button changes to  when you are working in Node Editing mode.





---

**Note:** If you click outside of the bounding box that surrounds the selected vector object once, ArtCAM Pro remains in Node Editing mode. If you click more than once, ArtCAM Pro returns to Select Vectors mode. For details, see "Selecting Vectors" on page 172.

---

## Selecting Points and Control Points

You can select single or multiple points and/or control points in a selected vector object.

1. Make sure that you are in Node Editing mode . For details, see "Editing Vector Nodes" on page 182.
2. Click to select the vector object containing the points and/or control points you want to edit. A bounding box surrounds it, within which you can see the spans, points (nodes) and control points that make up the selected vector object.
3. If you want to select a point (node) or control point:
  - Move the cursor over the point or control point that you want to select. When the  cursor changes to a

 , click to select it. The selected point or control point turns red.



If you select a point that has adjoining control points, these are selected along with the point itself. All of which turn red.

If you want to select more than one point (node) or control point, you can use any of the following methods:

- Click and drag to form a bounding box around them. The selected points and/or control points turn red.
- Click to select a point or control point. Hold the **Ctrl** key down on your keyboard, and then click on further points and/or control points to select them. The selected points and/or control points turn red.
- Click to select a point or control point. Hold the **Shift** key down on your keyboard, and then click to select a second point. ArtCAM Pro finds the shortest distance between these two points, and then selects all of the other points in between them. The selected points and/or control points turn red.

## ***Deselecting Points and Control Points***

If you want to deselect a point or control point:

- Move the cursor over the point or control point that you want to deselect. When the  cursor changes to a , hold the **Shift** key down on your keyboard and then click on the point or control point to deselect it.

## ***Moving Points***

You can move one or more points and/or control points to a new position.

To move a selection of points (nodes) and/or control points:

1. Make sure that you are in Node Editing mode . For details, see "Editing Vector Nodes" on page 182.
2. Click to select the vector object containing the points you want to move. A bounding box surrounds the selected vector, within which you can see the spans, points (nodes) and control points that make up the selected vector object.



3. Hold the **Shift** key down on your keyboard, and then click to select the points and/or control points that you want to move. For details, see "Selecting Points and Control Points" on page 183. The selected points and/or control points turn red.
4. You can now move the selected points and/or control points using either of the following methods:
  - Move the  cursor over any of the selected point(s) and then click and drag the point into its new position.
  - Use any of the four arrow keys on your keyboard to nudge the selected point(s) into its new position.

## Smoothing Points

You can smooth any point (node) in a vector object other than the Start Point or the last point in an ungrouped, open vector object. For details, see "Selecting Vectors" on page 172.

In smoothing, the span on either side of a point is converted to a bezier curve span. ArtCAM Pro positions control points next to the point, allowing you to control the degree of curvature in the whole vector object.

To smooth a single point:

1. Make sure that you are in Node Editing mode . For details, see "Editing Vector Nodes" on page 182.
2. Click to select the vector object containing the point you want to smooth. A bounding box surrounds it, within which you can see the spans, points (nodes) and control points that make up the selected vector object. All unsmoothed points are shown in black.
3. Move the cursor over the point that you want to smooth. When the  cursor changes to a , right-click to display the Vector Editing menu.
4. Click to select the **Smooth Point** option to convert the spans on either side of the point to bezier curves. The point turns blue.





---

**Note:** Moving the cursor over the point and pressing the **S** key on your keyboard also smooths it.

---

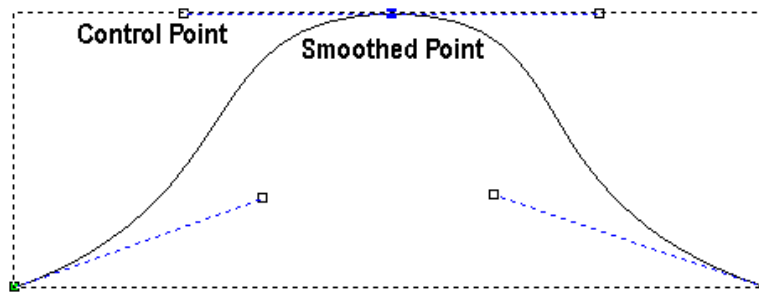
For example, the point in the middle of the vector object shown below has been smoothed:



If you move one of the control points next to the smoothed point, the other automatically moves with it. This simultaneous movement preserves the tangency between the two bezier curve spans.

To smooth a group of points:

1. Make sure that you are in Node Editing mode . For details, see "Editing Vector Nodes" on page 182.
2. Click to select the vector object containing the points you want to smooth. A bounding box surrounds it, within which you can see the spans, points (nodes) and control points that make up the selected vector object.
3. Select the points that you want to smooth. For details, see "Selecting Points and Control Points" on page 183.
4. Right-click on any of the selected points to display the Node Editing menu.
5. Click on the **Smooth Points** option to convert the spans on either side of the selected point(s) to bezier curves.





---

**Note:** Moving the cursor over any of the selected points and pressing the **S** key on your keyboard also smoothes them.

---

To remove the smoothing option from a smoothed point:

1. Make sure that you are in Node Editing mode . For details, see "Editing Vector Nodes" on page 182.
2. Click to select the vector object containing the smoothed points from which you want to remove the smoothing. A bounding box surrounds it, within which you can see the spans, points (nodes) and control points that make up the selected vector object.

3. Move the cursor over a smoothed point (node). When the cursor changes to a , right-click to display the Node Editing menu. The **Smooth Point** option is selected.
4. Click on the **Smooth Point** option to deselect it. The point (node) turns black.





---

**Note:** Moving the cursor over a smoothed point and pressing the **S** key on your keyboard also removes its smoothing.

---

Although the span on either side of the point (node) remains as a bezier curve span, deselecting the **Smooth Point** option causes the control point on either side of the point (node) to affect its adjoining bezier curve span only, rather than the whole vector object.

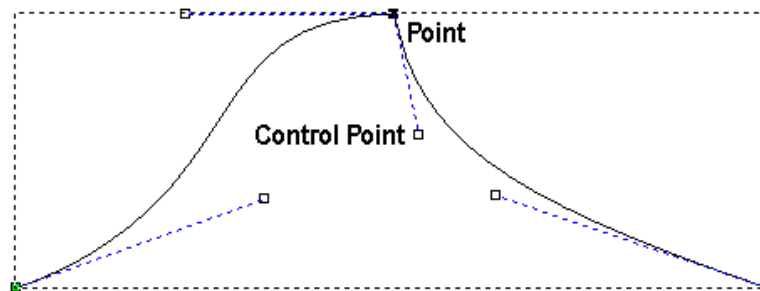

In our example, you can see that moving one control point no longer automatically moves the other:



## Deleting Points

You can delete any of the points (nodes) within a vector object. Deleting a point does not change the type of span on either side of the point but it does reduce your ability to manipulate the shape of the whole vector object.

To delete a single point:

1. Make sure that you are in Node Editing mode . For details, see "Editing Vector Nodes" on page 182.
2. Click to select the vector object containing the point you want to delete. A bounding box surrounds it, within which you can see the spans, points (nodes) and control points that make up the selected vector object.
3. Move the cursor over the point that you want to smooth. When the  cursor changes to a , right-click to display the Vector Editing menu.

4. Click to select the **Delete Point** option to delete the point from the vector object.



---

**Note:** You can also delete a point by moving the cursor over the point and then pressing the **D** key on your keyboard.

---

In the following example, you can see that in deleting the middle point, the number of control points is reduced and its shape is changed considerably:

*Before...*

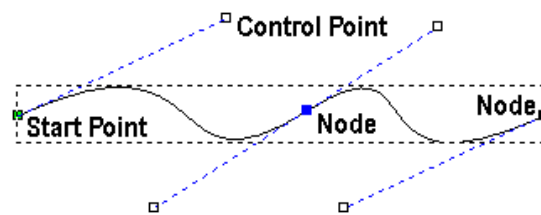

*After...*

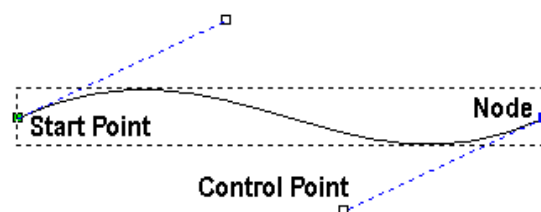

To delete a group of points:

1. Make sure that you are in Node Editing mode . For details, see "Editing Vector Nodes" on page 182.
2. Click to select the vector object containing the points you want to delete. A bounding box surrounds it, within which you can see the spans, points (nodes) and control points that make up the selected vector object.
3. Select the points that you want to delete. For details, see "Selecting Points and Control Points" on page 183.
4. Right-click on any of the selected points to display the Node Editing menu.
5. Click on the **Delete Points** option to delete the selected points.



---

**Note:** You can also delete the points by moving the cursor over any of the selected points and then pressing the **D** key on your keyboard.



---

## Changing the Start Point

The Start Point in a vector object determines the point at which a tool enters the block of material when you are machining your model.

You can change the position of the Start Point in any vector object. The green point within a selected vector object is the Start Point.

To change the position of the Start Point:

1. Make sure that you are in Node Editing mode . For details, see "Editing Vector Nodes" on page 182.
2. Click to select the vector object in which you want to change the position of its Start point. A bounding box surrounds it, within which you can see the spans, points (nodes) and control points that make up the selected vector object.
3. Move the cursor over the point that you want to set as the Start Point. When the  cursor changes to a , right-click to display the Node Editing menu.
4. Click on the **Start Point** option to make the selected point the Start Point. The point changes from black to green.



---

**Note:** You can also change the position of the Start Point by moving the cursor over the point you want to set as the new Start Point and then pressing the **P** key on your keyboard.

---

Using a toolpath preview in the **2D View** window, you can also set the position of the Start Point in any toolpath containing a profile pass. For further details, see "Changing the Start Point Position" in the Machining Models chapter.



## Changing the Position of Points

You can change the position of any point (node) or control point within a selected vector object.

To change the exact position of a point or control point:

1. Make sure that you are in Node Editing mode . For details, see "Editing Vector Nodes" on page 182.
2. Click to select the vector object in which you want to change the position of a point or control point. A bounding box surrounds it, within which you can see the spans, points

(nodes) and control points that make up the selected vector object.

3. Move the cursor over the point that you want to reposition. When the  cursor changes to a , right-click to display the Node Editing menu.
4. Click on the **Properties** option to display the **Point Properties** dialog box:

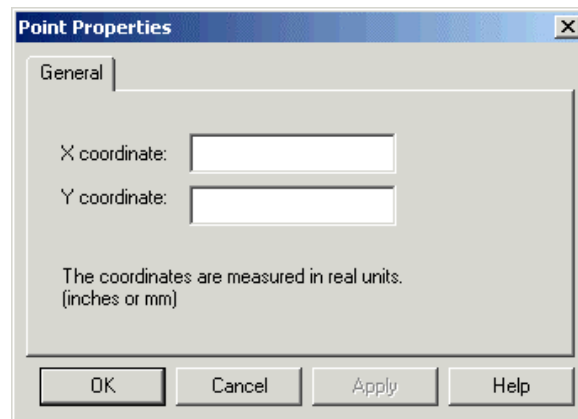

5. Define the X and Y co-ordinates of the point's new position in the **X coordinate** and **Y coordinate** boxes.
6. Click on the **OK** button to close the dialog box.

To change the approximate position of a point or control point:

1. Make sure that you are in Node Editing mode . For details, see "Editing Vector Nodes" on page 182.
2. Click to select the vector object in which you want to change the position of a point or control point. A bounding box surrounds it, within which you can see the spans, points (nodes) and control points that make up the selected vector object.
3. Click and drag on the point or control point into its new position. Release the mouse button to set its position.

## ***Aligning Points***

You can align a selection of points (nodes) and/or control points within a selected vector object in either the horizontal (X) or vertical (Y) axis.

To align a selection of points (nodes) and/or control points:

1. Make sure that you are in Node Editing mode . For details, see "Editing Vector Nodes" on page 182.



2. Click to select the vector object containing the points you want to align. A bounding box surrounds the selected vector, within which you can see the spans, points (nodes) and control points that make up the selected vector object.
3. Hold the **Shift** key down on your keyboard, and then click to select the points and/or control points you want to align with that selected last. For details, see "Selecting Points and Control Points" on page 183. The selected points and/or control points turn red.
4. Right-click on any of the selected points and/or control points to display the Node Editing menu.
5. Click on the **Align Nodes** option, followed by either the **in X** or the **in Y** option, depending on the axis with which you want to align the points and/or control points. By default, the point selected first is aligned with the point selected last, and a single horizontal (X) or vertical (Y) linear span replaces the intermediate points.



---

**Note:** You can also align selected points and/or control points along the X-axis by pressing the **X** key on your keyboard, and along the Y-axis by pressing the **Y** key on your keyboard.

---



---

**Note:** If you want to preserve all of the intermediate points (nodes) when aligning them with the X or Y axis, click to deselect the **Align Nodes – replace with a single line** option  on the **ArtCAM Options** page. For details, see "Managing ArtCAM Pro's Preferences" in the ArtCAM Pro Layout chapter.

---

## Deleting Vector Objects

You can delete a selected vector object or group of vector objects using any of the following methods:

- First, hold the **Shift** key down on your keyboard and then click to select the vector object that you want to delete. Next, right-click on any of the selected vector objects to display the Vector Editing menu, and then click on the **Delete** option.
- Select the vector objects that you want to delete, and then press the **Delete** key on your keyboard. For details, see "Selecting Vectors" on page 172.

- Select the vector objects that you want to delete, and then press the **Ctrl + X** keys on your keyboard. For details, see "Selecting Vectors" on page 172.

If you try to delete any locked vector objects, the following message box appears:

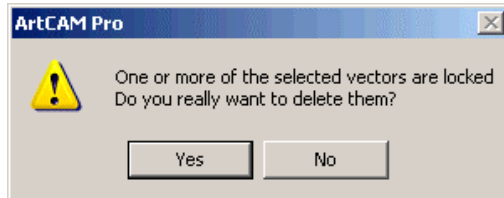

Click on the **Yes** button to close the message box and delete the selected vector object(s). For further information, see "Locking and Unlocking Vector Objects" on page 211 and "Locking the Vectors on a Layer" in the Working with Models chapter.

## Copying and Pasting Vector Objects

There are three buttons in the **File** area of the **Assistant's** Home page that you can use to copy, paste and cut vector objects in a model.

Using the **Block Copy / Rotate** button  in the **Vector Editing** area, you can also create multiple copies of a vector object in two regular patterns:

- Block copy. For details, see "Block Copy" on page 193.
- Rotate copy. For details, see "Rotate Copy" on page 196.

To copy, paste or cut a vector object:

1. Select the vector object that you want to copy, paste or cut. For details, see "Selecting Vectors" on page 172.







---

**Tip:** If you click and drag around a vector object and it has one or more overlaying copies, the selected vector object turns red. To move an overlaying copy, hold down the **Ctrl** key on your keyboard and then click and drag the copy into its new position.

---

2. In the **File** area of the **Assistant's** Home page, click on the appropriate button:

- Click on the **Cut** button  to remove the selected vector object and place it on the clipboard.

- Click on the **Copy** button  to create a duplicate of the selected vector object and place it on the clipboard.
- Click on the **Paste** button  to copy the selected vector object back from the clipboard into its original position.



---

**Note:** If you click and drag around a vector object that you want to select and it has one or more overlaying copies, the vector object turns red.

---

To move a pasted copy, move the cursor over the selected vector object until it changes to a , and then click and drag into position.





---

**Note:** You can also cut, copy or paste a selected vector object by clicking on the **Edit** menu in the Main menu bar, followed by the appropriate option.

---

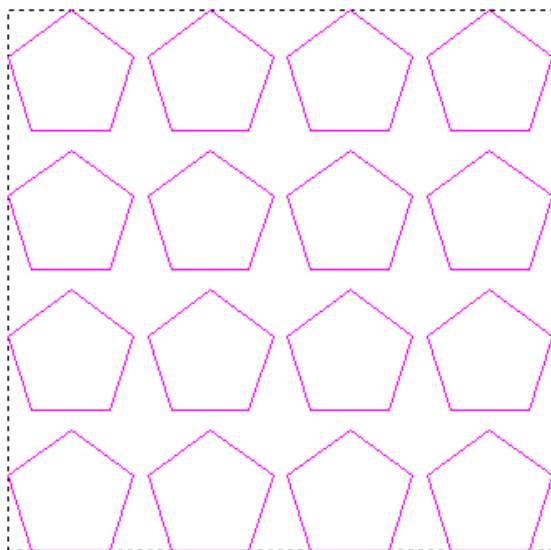

## ***Block Copy***

You can produce several copies of a selected vector object in a grid format:



To create a block of copies in a grid format:

1. Select the vector object that you want to copy and paste. For details, see "Selecting Vectors" on page 172. By default, it appears as magenta and is surrounded by a bounding box.

2. Click on the **Block Copy / Rotate** button  in the **Vector Editing** area of the **Assistant's Home** page to display the **Block and Rotate Copy** page.
3. Click on the **Block Copy** radio button  to display the settings on the page.
4. Select the method you want to use to set the distance between each copy within the block:
  - The **Distances are offsets** option allows you to set the distance at which each copy of a vector object will be created from the bottom left corner of the previous copy in the block. The overall distance between each copy equates to the height or width of the vector object plus the gap. The **Distances are offsets** radio button  is selected by default.

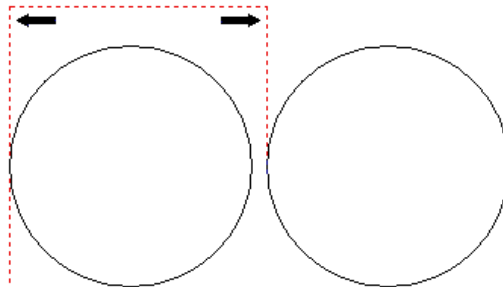

- Click on the **Distances are gaps** option allows you to set the distance and direction at which each copy of a vector object will be created from any of the four edges of the previous copy in the block. The overall distance between each copy equates to the defined gap. Click on the **Distances are gaps** radio button  to display its settings.

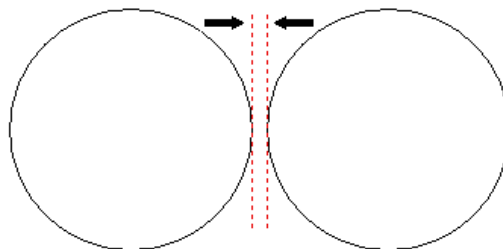

If you have selected the **Distances are offsets** option:

- First, define the distance you want to set between each copy along the X-axis in the **X Offset** box.
- Next, define the distance you want to set between each copy along the Y-axis in the **Y Offset** box.



---

**Note:** You can set the offset distance between each copy using a positive or negative value. To create a block of copies to the right of and above the selected vector object, define positive values in the offset boxes e.g. 90. To create a block of copies to the left of and below of the selected vector object, define negative values in the offset boxes e.g. -90.

---

- Finally, define the total number of copies by typing the number of rows and columns you want to create in the **Number of Rows** and **Number of Columns** boxes.

If you have selected the **Distances are gaps** option:

- First, define the width of the gap between each subsequent copy of the selected vector object along the X-axis in the **X Copy** box.
- Next, define the width of the gap between each subsequent copy of the selected vector object along the Y-axis in the **Y Copy** box.
- Now, define the total number of copies by typing the number of rows and columns you want to create in the **Number of Rows** and **Number of Columns** boxes.
- Finally, set the direction in which you want to create the block of copies:

The **Copy From Left To Right** button  allows you to copy the selected vector object to the right along the X-axis.

The **Copy From Right To Left** button  allows you to copy the selected vector object to the left along the X-axis.



---

**Note:** You can toggle between the **Copy From Left To Right** and **Copy From Right To Left** direction by clicking on whichever button is currently displayed.

---

The **Copy From Bottom To Top** button  allows you to copy the selected vector object upwards along the Y-axis.

The **Copy From Top To Bottom** button  allows you to copy the selected vector object downwards along the Y-axis.



---

**Note:** You can toggle between the **Copy From Bottom To Top** and **Copy From Top To Bottom** direction by clicking on whichever button is currently displayed.

---

5. Click on the **Apply** button to create the new block of vector objects.
6. Click on the **Close** button to return to the **Assistant's** Home page.

## Rotate Copy

You can produce several copies of a selected vector object in a circular pattern by defining a rotation centre:

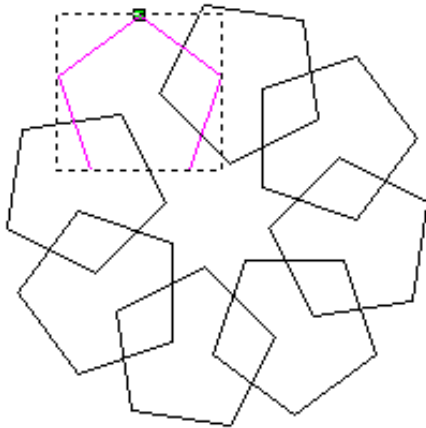

To create multiple copies in a circular pattern:

1. Select the vector object that you want to copy and paste. For details, see "Selecting Vectors" on page 172. By default, it appears as magenta and is surrounded by a bounding box.
2. Click on the **Block Copy / Rotate** button  in the **Vector Editing** area of the **Assistant's** Home page to display the **Block and Rotate Copy** page.

3. Click on the **Rotate Copy** radio button  to display the settings on the page.
4. Define the point around which you want to rotate the selected vector object. You can either:
  - Define the X and Y co-ordinates of the origin of rotation in the **Rotation Centre X** and **Rotation Centre Y** boxes.
  - Click to select the **Pick Centre with Mouse** option . Move the  cursor over the point in the model (white area) that you want to use as the origin of rotation, and then click to select. Its co-ordinates appear in the **Rotation Centre X** and **Rotation Centre Y** boxes.
5. Define how each of the copies are rotated by clicking on either of the **Angle** radio buttons :
  - **Incremental** - To rotate each subsequent copy of the selected vector object by a specified angle.
  - **Total** - To rotate each copy of the selected vector object evenly within a specified angle.
6. Define the angle of rotation in the **degrees** box:
  - Type a positive value to rotate the vector object clockwise.
  - Type a negative value to rotate the vector object anti-clockwise.
7. Define the number of copies you want to create in the **Number of Objects** box.
8. Click on the **Apply** button to create the new circular pattern of vector objects.
9. Click on the **Close** button to return to the **Assistant's** Home page.

## Offsetting Vector Objects

You can create an offset vector from any of the vector objects already drawn in your model.

To create an offset vector from a vector object:



1. Select the vector object from which you want to create an offset vector. For details, see "Selecting Vectors" on page 172.
2. Click on the **Offset Vector(s)** button  in the **Vector Editing** area of the **Assistant's** Home page to display the **Offset Vector(s)** page.



---

**Note:** You can also display the **Offset Vector(s)** page from the Main menu bar by clicking on the **Vectors** menu, followed by the **Offset...** option.

---

3. Define the distance between the selected vector object and the offset vector in the **Offset Distance** box.
4. Click to select one of the **Offset Direction** radio buttons  to set the position of the offset vector:
  - Select **Outwards/Right** if you want the offset vector to be drawn outside of the selected vector object if it is closed, or to the right of the Start Point, looking down the selected vector object if it is open.
  - Select **Inwards/Left** if you want the offset vector to be drawn within the selected vector object if it is closed, or to the left of the Start Point, looking down the selected vector object if it is open.
  - Select **Both Sides (Ridge)** if you want two offset vectors to be drawn. One inside and another outside of the selected vector object if it is closed, or on either side of the Start Point, looking down the selected vector object if it is open.
5. Click to select one of the **Offset Corners** radio buttons  to set the shape of the corners in the offset vector:
  - Select the **Radiused** option if you want the corners of the offset vector to appear as arcs with a radius equal to the **Offset Distance**.
  - Select the **Chamfered** option if you want the corners of the offset vector to appear as chamfers.
  - Select the **Sharp** option if you want the corners of the offset vector to appear as sharp points.



If you select the **Sharp** option, define the maximum offset distance before a chamfer is applied to a sharp corner in the **Max. Sharp Offset Distance** box.

The value you define should represent a percentage of the overall **Offset Distance**. For example, if the **Offset Distance** is 4 mm and the **Max. Sharp Offset Distance** is set to 50%, a chamfer is applied to the offset corners at 6 mm ( $4 + 50\%$  of  $4 = 6$ ).

6. If you want to replace the original vector object with the offset vector, click to select the **Delete original vectors** option .
7. Click on the **Offset** button to draw the offset vector.

The **Offsetting Contours** message box is displayed while ArtCAM Pro calculates the position of the offset vector(s):

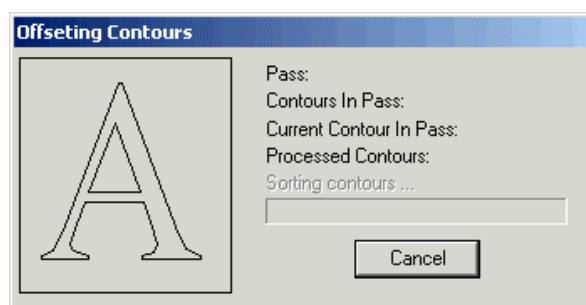

---

**Note:** You may not see the **Offsetting Contours** message box if you are creating an offset vector from a simple shape of vector object. For example, a circle.

---

8. Click on the **Close** button to return to the **Assistant's** Home page.

You can also display the **Offset Vector(s)** page in the **Assistant** window if you:

1. Select the vector object from which you want to create an offset vector. For details, see "Selecting Vectors" on page 172.
2. From the Main menu bar, click on the **Vectors** menu, followed by the **Offset...** option.

## Splining Vector Objects

You can take a selection of points (nodes) within a selected vector object and convert their adjoining linear or arc spans into a single

bezier curve span. This process is referred to as 'splining'. For further information on spans, see "Editing Vector Spans" on page 175. The vector object must be ungrouped.

In the following example, you can see vector artwork in the shape of a shark made up entirely of linear spans. When the linear spans between a selection of four points (nodes) along the top of the vector artwork are splined, you can see the its shape changes considerably:

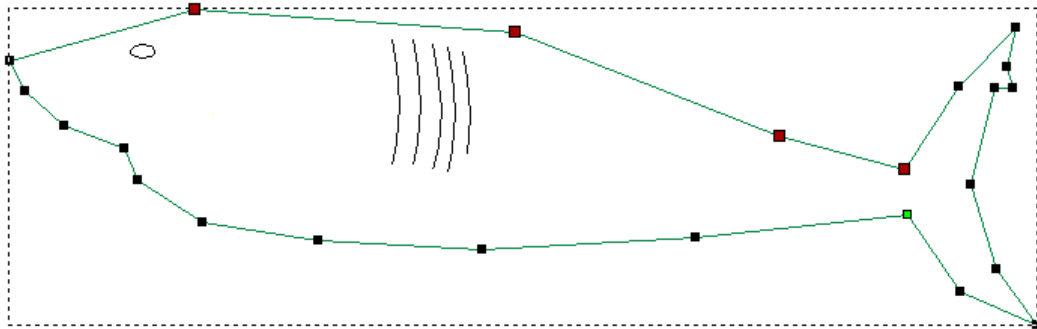

*Before...*

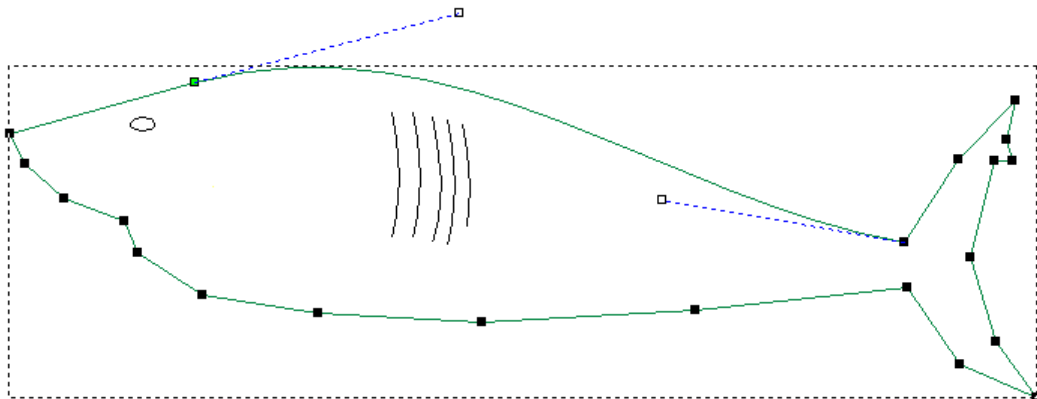

*After...*



To spline a vector object or selection of points (nodes) within a vector object:

1. Make sure that you are in **Node Editing** mode . For details, see "Editing Vector Nodes" on page 182.
2. Click to select the ungrouped vector object that you want to spline. A bounding box surrounds it, within which you can see the spans, points and control points that make up the selected vector object.
3. Click on the **Spline Vectors** button  in the **Vector Editing** area of the **Assistant's** Home page to display the **Smooth Vectors** page.



---

**Note:** You can also display the **Spline Vectors** page from the Main menu bar by clicking on the **Vectors** menu, followed by the **Spline Vectors...** option.

---

4. If you only want to spline specific spans within the selected vector object, click to select the points and/or control points to which these spans are attached. The selected points turn red. For details, see "Selecting Points and Control Points" on page 183.

In the **Selected Vectors Information** area, ArtCAM Pro displays the total number of spans and points (including control points) within the selection, and the number of linear, arc and bezier spans that make up the total.

5. If you only want convert spans to bezier spans that are within a specific tolerance, define the maximum distance the point (node) can be from the selected span in the **Tolerance** box.
6. If you want to keep all linear spans within the current selection equal to or greater than a specific length, click on the **Preserve Straight Spans** option  and then define the length in the **Keep lines longer than** box.

Otherwise, leave the default **Ignore Straight Spans** option  selected to replace all of the linear and arc spans within the current selection with bezier curve spans.

7. Click on the **Spline** button to spline all selected spans  
The linear and/or arc spans joined to the selected points are converted to bezier spans. ArtCAM Pro displays the new total number of spans and points (including control points) within the selection, and the new number of linear, arc and bezier spans that make up the total.
8. Click on the **Close** button to return to the **Assistant's** Home page.

You can also display the **Spline Vectors** page in the following way:

1. Make sure that you are in **Node Editing** mode . For details, see "Editing Vector Nodes" on page 182.
2. Click to select the vector object that you want to spline. A bounding box surrounds it, within which you can see the

spans, points and control points that make up the selected vector object.

3. Select the points (nodes) and/or control points to which the spans in the vector object you want to spline are attached. For details, see "Selecting Points and Control Points" on page 183.



---

**Note:** You can also display the **Spline Vectors** page from the Main menu bar by clicking on the **Vectors** menu, followed by the **Spline Vectors...** option.

---

4. Right-click on any of the selected points to display the Node Editing menu, and then click on the **Spline Vectors...** option to display the **Spline Vectors** page.

In the **Selected Vectors Information** area, ArtCAM Pro displays the total number of spans and points (including control points) within the selection, and the number of linear, arc and bezier spans that make up the total.

5. If you only want convert spans to bezier spans that are within a specific tolerance, define the maximum distance the point (node) can be from the selected span in the **Tolerance** box.
6. If you want to keep all linear spans within the current selection equal to or greater than a specific length, click on the **Preserve Straight Spans** option  and then define the length in the **Keep lines longer than** box.

Otherwise, leave the default **Ignore Straight Spans** option  selected to replace all of the linear and arc spans within the current selection with bezier curve spans.

7. Click on the **Spline** button to spline all selected spans.

The linear and/or arc spans joined to the selected points are converted to bezier spans. ArtCAM Pro displays the new total number of spans and points (including control points) within the selection, and the new number of linear, arc and bezier spans that make up the total.

8. Click on the **Close** button to return to the **Assistant's** Home page.

You can also display the **Spline Vectors** page in the following way:

1. Make sure that you are in **Node Editing** mode . For details, see "Editing Vector Nodes" on page 182.
2. Click to select the vector object that you want to spline. A bounding box surrounds it, within which you can see the spans, points and control points that make up the selected vector object.
3. Select the points (nodes) and/or control points to which the spans in the vector object you want to spline are attached. For details, see "Selecting Points and Control Points" on page 183.
4. Right-click on any of the selected points to display the Node Editing menu, and then click on the **Spline Vectors...** option to display the **Spline Vectors** page.

## ***Restoring the Original Shape of a Splined Vector***

You can undo the splining applied to a vector object, allowing you to restore its original shape, using either of the following methods:

- From the Main menu bar, click on the **Edit** menu, followed by the **Undo Spline Vectors** option.
- Press the **Ctrl + Z** keys on your keyboard.

## **Filleting Vector Objects**

A fillet is an arc, which is made up of two points (nodes) and a control point. ArtCAM Pro allows you to define and subsequently edit the radius of the fillet arc that you create.

You can close an open vector object with a fillet, or by joining the two points at the junction. In the latter instance, ArtCAM Pro extends the spans connected to the two points.



---

**Note:** Not all open vector objects can be closed with a fillet. For practical results, a vector object should contain at least three points (nodes) and have sufficient space to fit the fillet arc.

---

You can also convert a sharp corner within a vector object into a filleted, or rounded, corner.

To convert a sharp corner into a filleted corner:

1. Select the vector object in which you want to insert filleted corners. For details, see "Selecting Vectors" on page 172.

- Click on the **Fillet Vector With An Arc** button  in the **Vector Editing** area to display the **Fillet Tool** page.





---

**Note:** You can also display the **Fillet Tool** page by clicking on the **C** key on your keyboard when a vector object is selected.

---

- Click to select the **Insert Fillet** radio button .
- Define the radius of the filleted corner you want to insert in the **Fillet Radius** box.
- Move the cursor over the point (node) in the selected vector object, and then click to insert the fillet. The existing point is converted into two points and a control point.

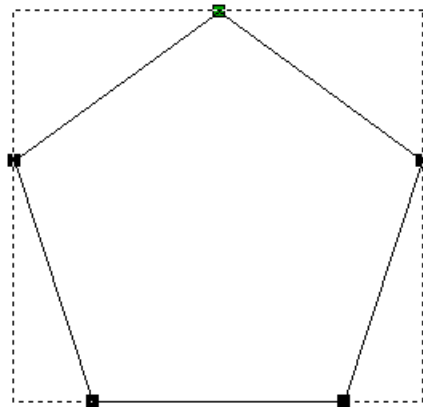
*Before...*



*After...*

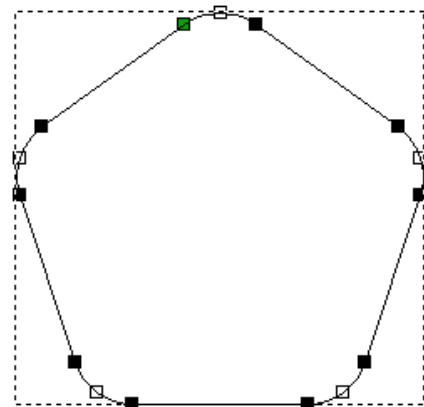

- Click on the **Close** button to return to the **Assistant's** Home page.

You can also convert a sharp corner into a filleted corner if you:

- Select the vector object in which you want to insert filleted corners. For details, see "Selecting Vectors" on page 172.
- Click on the **Fillet Vector With An Arc** button  in the **Vector Editing** area to display the **Fillet Tool** page.



---

**Note:** You can also display the **Fillet Tool** page from the Main menu bar by clicking on the **Vectors** menu, followed by the **Fillet...** option.

---

- Click to select the **Insert Fillet** radio button .
- Define the radius of the filleted corner you want to insert in the **Fillet Radius** box.

5. Click on a span on either side of a point (node) or intersection in the selected vector. The \* icon appears on the selected span.
6. Click on the span opposite to that already selected to insert the fillet. The existing point or intersection is converted into two points and a control point.

*Before...*

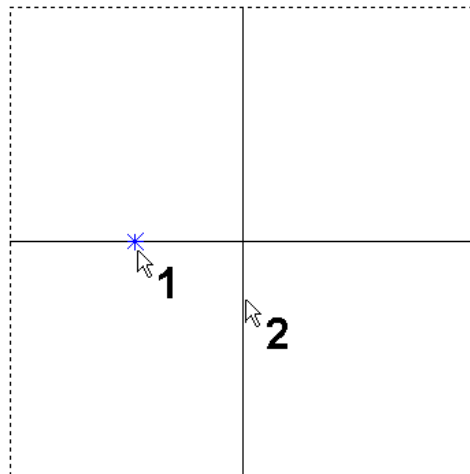

*After...*

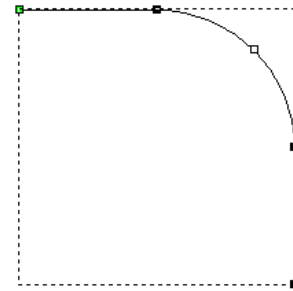





---

**Note:** If the radius of the fillet is too large or the selected spans are not parallel, a warning message appears on the page in red text. This message disappears within a few seconds.

---

7. Click on the **Close** button to return to the **Assistant's** Home page.

To close an open vector object with extended spans:

1. Select the vector object in which you want to insert filleted corners. For details, see "Selecting Vectors" on page 172.
2. Click on the **Fillet Vector With An Arc** button  in the **Vector Editing** area to display the **Fillet Tool** page.
3. Click to select the **Extend/Trim Line to Intersection** radio button .
4. Click to select the first point (node) in the junction of the open vector object. The  icon appears around the selected point.
5. Click to select the second point in the junction. ArtCAM Pro joins the two points, extending their connecting spans whilst doing so.

*Before...*

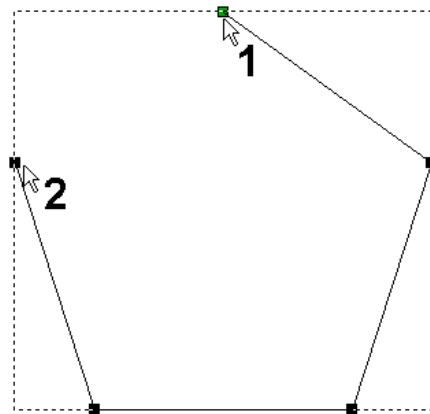

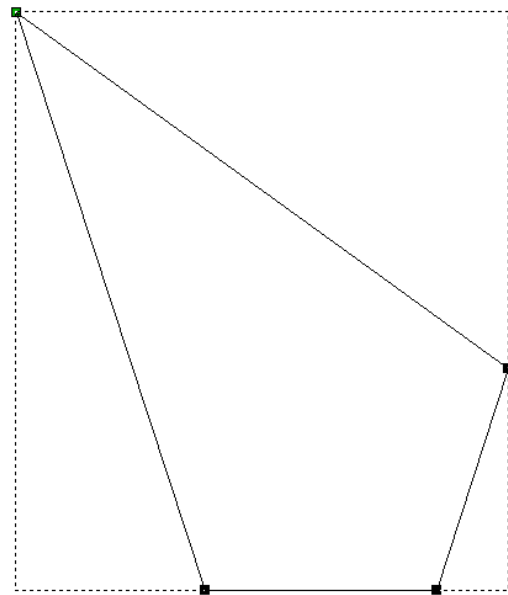

*After...*



6. Click on the **Close** button to return to the **Assistant's** Home page.

To close an open vector object with a fillet:

1. Select the vector object that you want to close with a fillet. For details, see "Selecting Vectors" on page 172.
2. Click on the **Fillet Vector With An Arc** button  in the **Vector Editing** area to display the **Fillet Tool** page.
3. Click to select the **Insert Fillet** radio button .
4. Define the radius of the fillet with which you want to close the vector object in the **Fillet Radius** box. The wider the radius, the shorter the extended spans.
5. Click to select the first point in the junction of the open vector object. The  icon appears around the selected point.
6. Click to select the second point in the junction. ArtCAM Pro joins the two points with a fillet, extending their adjoining spans whilst doing so.



*Before...*

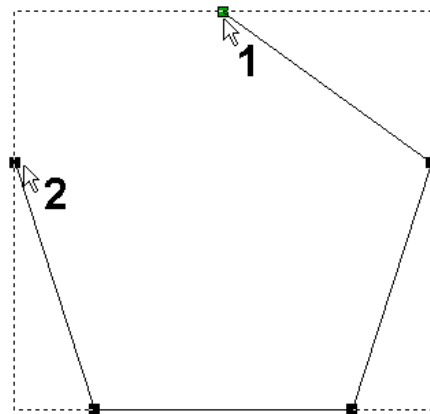

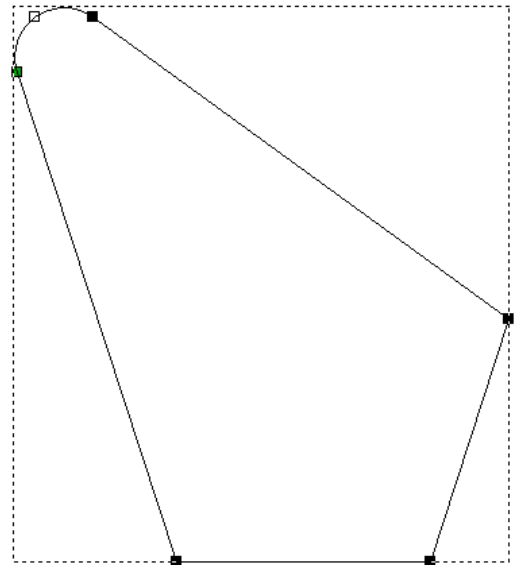

*After...*



7. Click on the **Close** button to return to the **Assistant's** Home page.

## ***Editing a Fillet***

You can alter the radius of a fillet after it has been created:

1. Select the vector object containing the fillet that you want to edit. For details, see "Selecting Vectors" on page 172.
2. Click on the **Fillet Vector With An Arc** button  in the **Vector Editing** area to display the **Fillet Tool** page.
3. Click to select the **Insert Fillet** radio button .
4. Define the new radius of the fillet in the **Fillet Radius** box.
5. Click on the control point between the two points in the fillet to alter its radius.
6. Click on the **Close** button to return to the **Assistant's** Home page.

## **Trimming Vector Objects**

You can control exactly which part of any number of overlapping vector objects you want to remove.

To trim two or more ungrouped overlapping vectors:

1. Make sure that you are in **Node Editing** mode . For details, see "Editing Vector Nodes" on page 182.



2. Select the vector objects that you want to trim. The vector objects turn magenta and a bounding box surrounds them.
3. Click on the **Trim Vector To Intersections** button  in the **Vector Editing** area to display the **Trim Tool** page.



---

**Note:** You can also display the **Trim Tool** page from the Main menu bar by clicking on the **Vectors** menu, followed by the **Trim...** option.





---

4. If you want to create a copy of the original vector object you are trimming, click to select the **Keep Original** option . The copy is overlaying the original vector object.
5. Move the  cursor over a span within the area in which the vector objects overlap. When the cursor changes to , click to delete the span.

ArtCAM Pro creates a point (node) at each place where the vector object that you are trimming intersects with the overlapping vector object.

The next available intersection point (node) in the trimmed vector object's original direction of geometry becomes its start point.



To trim two or more grouped overlapping vectors:

1. Make sure that you are in **Node Editing** mode . For details, see "Editing Vector Nodes" on page 182.
2. Select the grouped vector objects that you want to trim. The grouped vector objects turn purple and a bounding box surrounds them.
3. Click on the **Trim Vector To Intersections** button  in the **Vector Editing** area to display the **Trim Tool** page.
4. Click on the **Explode Selection** button. ArtCAM Pro ungroups the vector objects and then converts the spans between every two points (nodes) within them into individual vector objects.
5. Move the  cursor over a span that you want to remove. When the cursor changes to , click to delete the span.
6. Click on the **Close** button to return to the **Assistant's** Home page.

## Wrapping Vectors to a Relief

You can wrap vector objects across the surface of a relief. After being wrapped, the selected vector object is restructured in the **2D View** window. You can apply a three-dimensional shape to the restructured vector object, and then combine this with the existing relief. This allows you to maintain the surface area of the original vector object in the relief.

To wrap a vector object to a relief:

1. Select the vector object that you want to wrap across the relief surface. For details, see "Selecting Vectors" on page 172.
2. Click on the **Wrap Vectors To Relief** button  in the **Vector Editing** area to display the **Wrap Vectors To Relief** page.
3. In the **Wrap Mode** area, click to select the wrapping method that you want to use:
  - **Radial** – This option allows you to wrap the clipart relief around a spherical shape, curved around the X and Y-axes.
  - **Cylindrical Wrap in X** – This option allows you to wrap the clipart relief around a cylindrical shape that is curved around the X-axis.
  - **Cylindrical Wrap in Y** – This option allows you to wrap the clipart relief around a cylindrical shape that is curved around the Y-axis.
4. In the **Wrap Origin** area, define the origin around which the selected vector object will be wrapped. You can use any of the following methods:
  - Click on any of radio buttons  on the rectangle diagram. The X and Y co-ordinates of the chosen origin appear in the **X** and **Y** boxes.
  - Type the X and Y co-ordinates of the origin in the **X** and **Y** boxes.
  - Click on the **Use Mouse** option , followed by the **Start** button. Move the cursor to the position in the **2D View** window that you want to use as the origin,

and then click. The X and Y co-ordinates of the origin appear in the **X** and **Y** boxes.

5. If you want to keep a copy of the selected vector object in its original form, make sure that the **Keep Original Vectors** option is checked on .
6. Click on the **Wrap** button to wrap the selected vector across the relief surface. ArtCAM Pro restructures the vector object in the **2D View** window.

For example, the vector text *wrapped* is wrapped around the X-axis of a bottle-shaped relief. ArtCAM Pro restructures the vector text. A plane with a start height of 1 mm is applied to the wrapped text and added to the relief. The surface area of the vector text is maintained, unlike when it has been projected, as shown below:

*Projected Vector Text...*



*Projected Vector Text Combined with Relief...*



*Vector Text Wrapped in X...*



*Wrapped Vector Text Combined with Relief...*



7. Click on the **Close** button to return to the **Assistant's** Home page.

## Locking and Unlocking Vector Objects

You can prevent a vector object from being moved to a different position in your model by locking it.

To lock a vector object in its current position:

1. Select the vector object that you want to lock into position. For details, see "Selecting Vectors" on page 172.
2. Right-click to display the Vector Editing menu, then select the **Lock Vector(s)** option. The selected vector object turns green. When deselected it appears as grey.

If you want to move any vector object that has previously been locked into position:

1. Select the locked vector object that you want to move. For details, see "Selecting Vectors" on page 172.
2. Right-click to display the Vector Editing menu, then select the **Unlock Vector(s)** option.

## Fitting Arcs to Vector Objects

You can automatically replace all of a selected vector object's bezier curve spans with a series of arc spans whilst maintaining its original shape.

To do so:

1. Select the vector object whose bezier curves you want to convert to arcs. For details, see "Selecting Vectors" on page 172.
2. Click on the **Arc Fit Vectors** button  in the **Vector Editing** area of the **Assistant's** Home page to display the **Fit Arcs To Vectors** page.



---

**Note:** You can also display the **Fit Arcs To Vectors** page from the Main menu bar by clicking on the **Vectors** menu, followed by the **Fit Arcs to Vectors...** option.

---

The number of spans (linear, bezier curve and arc) points and control points for the vector object is displayed in the **Selected Vectors Information** area.



---

**Note:** The points and control points in a selected vector object are grouped together under **Points** in the **Selected Vectors Information** area of the page.

---

3. Define how closely you want the arc spans to follow the original shape of the bezier curve spans in the **Tolerance** box.
4. Click on the **Fit Arcs** button to convert all bezier curve spans to arc spans. The new span, point and control point details are shown in the **Selected Vectors Information** area.



---

**Note:** If a bezier curve span in the selected vector object has no curvature, it is automatically converted to a linear span.

---

5. Click on the **Close** button to return to the **Assistant's** Home page.



---

**Note:** If a bezier curve span in the selected vector object has no curvature, it is automatically converted to a linear span.

---

New points and control points appear on the selected vector object. These can be used to manipulate the shape of the vector object further. For details, see "Editing Vector Spans" on page 175 and "Editing Vector Nodes" on page 182.

## Nesting Vector Objects



If you have an area of material that cannot contain a block of vector text as it is normally written, or a group of vector objects, you need not treat it as waste material.

Rather than creating the space to fit the vector text or group of objects in the conventional sense, you can manipulate them to fit into what space is available.

Using the **Nest Selected Vectors** button  in the **Position Size Align Vectors** area of the **Assistant's** Home page, you can be as economical as possible with your material.

You can nest vector objects within another vector object or the model area (the white area). If you are nesting vector objects within another, you must create a closed vector object that represents the shape of

material you have available in which to machine. You can use the tools in the **Vector Editing** area to define its shape. For example, if you have an odd shape of material available in which you want to nest vector text, use the **Create Polyline** tool to reproduce its outline. For details, see "Creating a Polyline" on page 152.

For example, consider the vector text *nesting vectors* before and after it has been nested inside a rectangle:



*Before...*

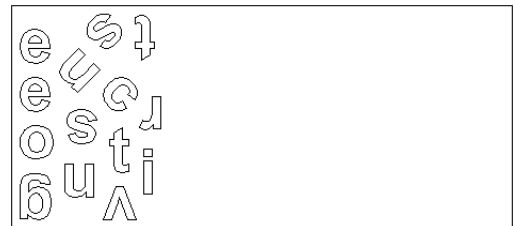

*After...*



To nest vector objects:

1. Make sure that you are in **Select Vectors** mode . For details, see "Selecting Vectors" in the Working with Vectors chapter of the Reference Manual.
2. Click on the **Nest Selected Vectors** button  in the **Position Size Align Vectors** area of the **Assistant's** Home page to display the **Nesting** page.



---

**Note:** You can also display the **Nesting** page from the Main menu bar, by clicking on the **Vectors** menu followed by the **Nest Vectors** option.

---

3. If the current ArtCAM model area (the white area) does not represent the piece of material in which you want to nest objects:
  - First, draw and select the vector representing the piece of material you have available to machine
  - Next, hold down the **Shift** key down on your keyboard and select all of the vectors that you want to nest within the selected vector.

By default, selected vectors are always nested within the vector you select first in the **2D View** window.

If the model area (the white area) shown in the **2D View** is representative of your exact material dimensions:

- Click to select the **Model is Sheet** option .
- Select all of the vectors that you want to nest within the model area.

In the following example, the model area represents our material. We can see that all of the vectors we want to nest within the model area are selected:

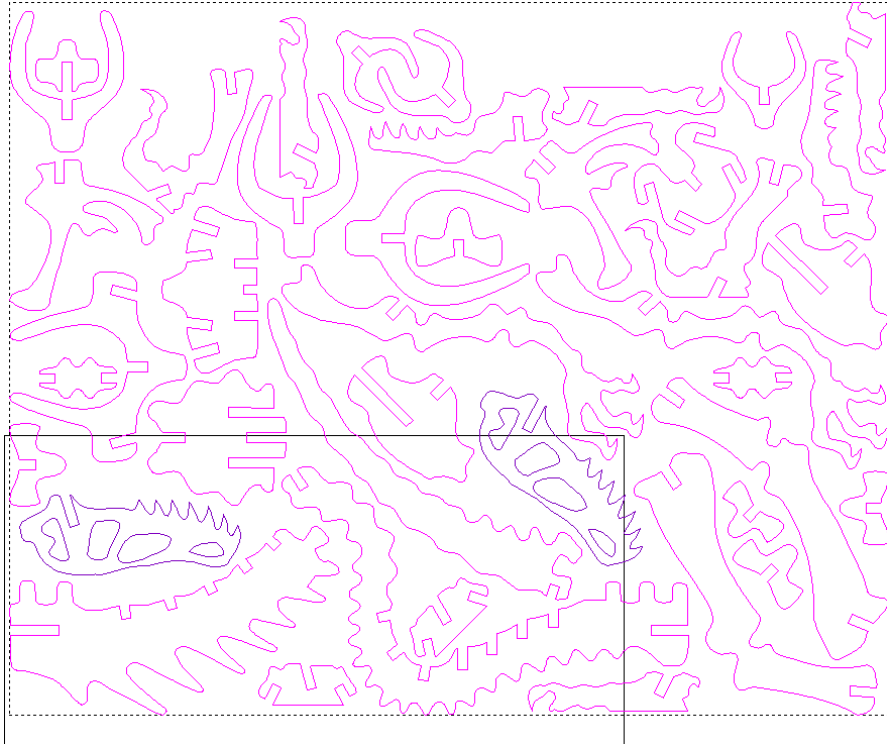

4. Define the diameter of the cutting tool that you are using to machine the nested vectors in the **Diameter (D)** box.
5. Define the amount of additional material that you want to surround each of the nested vectors in the **Tool Clearance (C)** box.
6. If you want to allow the selected vectors to be rotated during the nesting process, click to select the **Allow Part Rotation** option  and then define the increment by which you want ArtCAM Pro to rotate the vectors in the **Step Angle (A)** box.

For example, if the **Step Angle (A)** is defined as 90°, ArtCAM Pro attempts to nest the vectors, rotating them by 0°, 90°, 180° and 270° in sequence.



This and the remaining options on the page provide ArtCAM Pro with flexibility when fitting vectors into the available space.

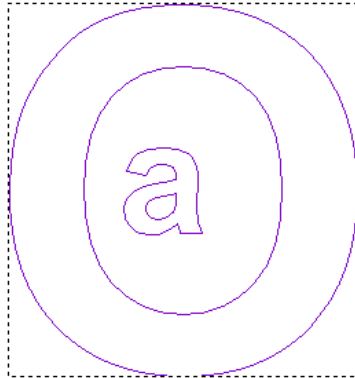

7. If you want to allow the selected vectors to be nested inside of those vectors within the selection that have a central cavity, click to select the **Allow Parts in Parts** option .

In the example shown, the letter *a* is nested within the central cavity of the letter *O*:



8. Click to select one of the following options from the **Nest From** list box:
  - **Bottom Left** – To nest the selected vector objects from the bottom-left corner of the model area.
  - **Bottom Right** – To nest the selected vector objects from the bottom-right corner of the model area.
  - **Top Left** – To nest the selected vector objects from the top-left corner of the model area.
  - **Top Right** – To nest the selected vector objects from the top-right corner of the model area.
9. Click on the **Nest Direction** list box, and then on the axis along which you want to nest the selected vectors. The X-axis is selected by default.
10. Define how closely you want the cutting tool to maintain the shape of the nested vectors in the **Curve Tolerance** box.
11. If you want to nest a block of vector text or a group of vectors exactly as it is shown in the **2D View** window, click to select the **Don't nest inner vectors (preserve groups)** option .
12. If you want to create a vector in the shape of the disposable material that remains after the selected vectors have been

nested, click to select the **Create Leftover Material Vector** option .

13. If you want to nest multiple copies of each of the selected vectors, click to select the **Nest Multiple Copies** option  and then define the number of copies that you want to create in the box below.
14. If you want to group the vectors contained on each sheet, click to select the **Group Nested Vectors** option .
15. Click on the **Nest** button to nest the selected vectors onto sheets.

A progress bar appears beneath the **2D View** window indicating the progress made in calculating the final position of the nested vectors:



The calculation time depends on the nesting options you have selected: the fewer the options you have selected, the faster the nesting process. You can click on the **Cancel** button  at any time to stop the nesting process.

The arrangement of the rows and columns of sheets shown in the **2D View** window will vary according to the most economical use of the available space.

In our example, we have allowed for part rotation using a step angle of 45 degrees only. The default sheet and the four sheets of nested vectors are arranged as shown:

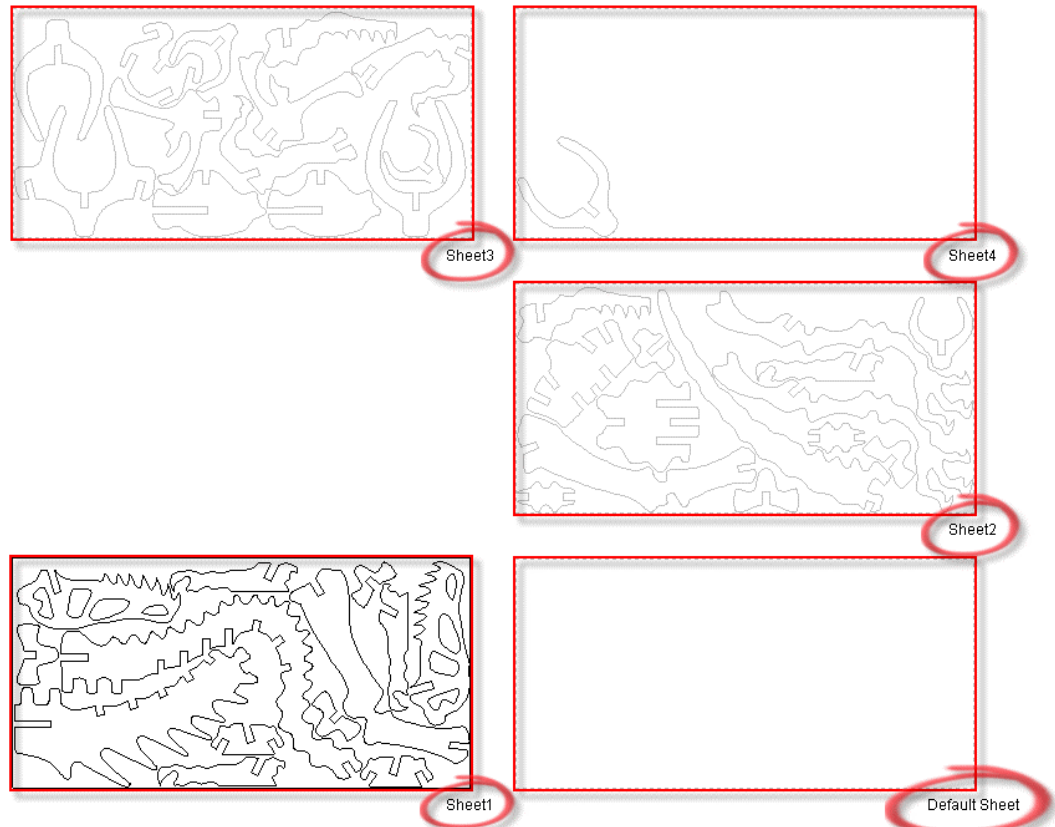

Each sheet of nested vectors is listed on the **Layers** page. You can control which sheet of nested vectors is shown in the **2D View** window by clicking to select the name of the specific *Sheet* you want to view from the **Active Sheet** list box. Only one sheet can be active at any given time, although it is possible to preview the contents of all sheets. You can only edit the vector artwork on the active sheet. In our example, the sheets are listed as shown with *Sheet1* selected as the active layer:

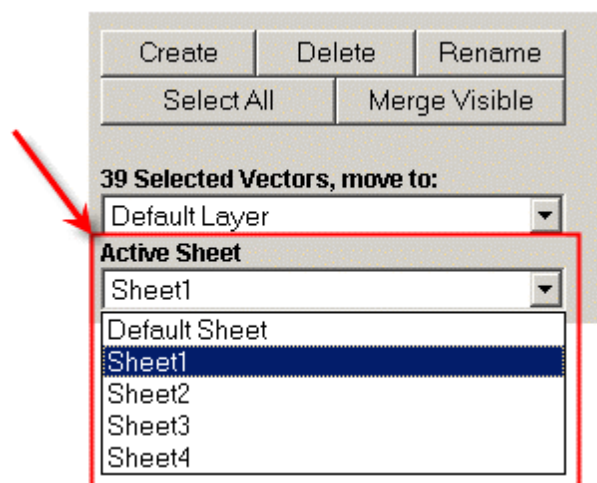

All identical sheets of nested vectors are merged into a single sheet. For example, if the second, third and fourth sheet of nested vectors were identical, all of them would be merged into a single sheet named *Sheets 2 to 4*.

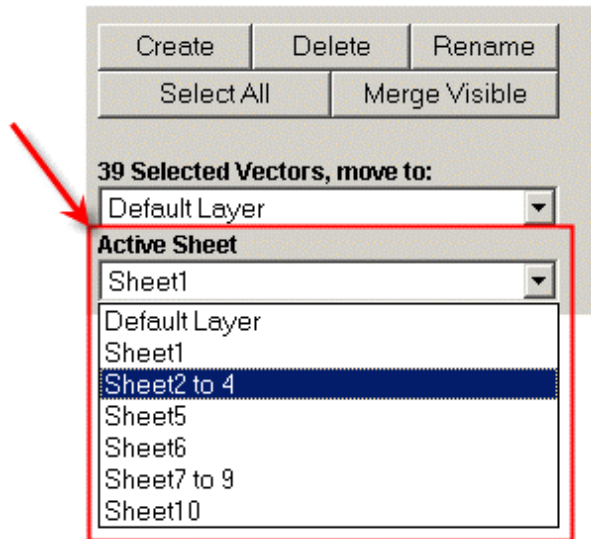

During the manufacturing process, you need only create the necessary toolpath(s) using this single sheet and machine it three times to machine the required number of pieces.

16. Click on the **Close** button to return to the **Assistant's** Home page.

## Distorting Vector Objects

You can distort the shape of any selected vector object or vector text drawn within a model. When working in envelope distortion mode, ArtCAM Pro converts the four sides of the bounding box that surrounds a selected vector object into bezier spans. Moving the nodes and control points that make up the distortion envelope around the selected vector object allows you to manipulate its original shape. This in turn allows you to add perspective to your vector artwork. You can also move, resize, rotate or shear the distortion envelope, which allows you to restructure your vector artwork easily.



To distort the shape of a vector object or text:

1. Select the vector object that you want to distort. For details, see "Selecting Vectors" on page 172.
2. Click on the **Envelope Distortion** button  in the **Vector Editing** area to display the **Envelope Distortion** page. The four sides of the bounding box surrounding the

selected vector object change to bezier spans. The gridlines drawn within these spans indicate that you are now in envelope distortion mode.

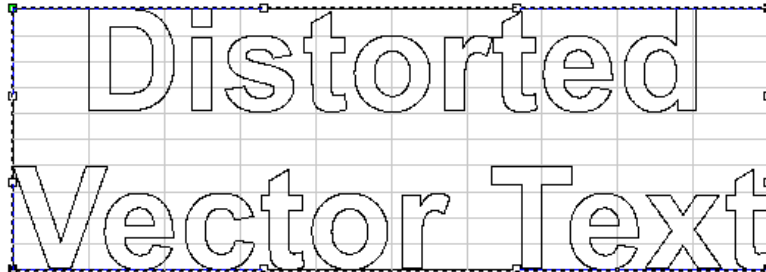
For example, a block of vector text appears as follows whilst working in envelope distortion mode:



3. In the **Editing Mode** area, select the mode you want to use to manipulate the distortion envelope:
  - Click on the **Edit Distortion Envelope Nodes** button  if you want to adjust the shape of the distortion envelope. For details, see "Editing Vector Spans" on page 175 and "Editing Vector Nodes" on page 182.
  - Click on the **Transform Envelope** button  if you want to move, resize, rotate or shear the distortion envelope. For details, see "Transforming Vector Objects" on page 9.
4. If you want to use either one or two curved vector objects selected from the **2D View** window to control the dimensions and position of a new distortion envelope which can be used to manipulate copies of the distorted vector object, click to select the **Use existing curve(s)** option  to display its settings.

If you want to use a single curved vector object:

- First, click to select the **Wrap along single curve** radio button . This option is selected by default. The **Wrap between 2 curves** settings are greyed-out.
- Next, click to select the curved vector object that you want to use from the **2D View** window, and then click on the **Select Curve...** button. For details, see "Selecting Vectors" on page 172.

An arrow appears on the selected vector object indicating the direction in which the distorted vector object will be pasted along it. The Start Point is shown in green.

For example, you might use a polyline something like that shown in the following image:

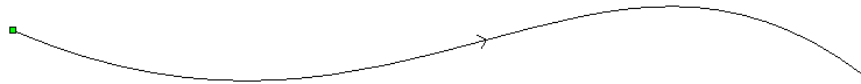

- Finally, click on the list box and then on the option that you want to use to control the position of the distortion envelope relative to the selected vector object:

**Left** – Click to select this option if you want to position the distortion envelope to the left of the selected vector object's Start Point, looking down the vector.

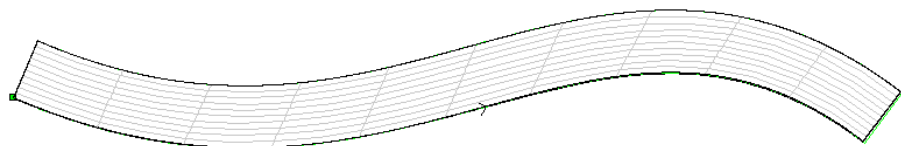

**Right** – Click to select this option if you want to position the distortion envelope to the right of the selected vector object's Start Point, looking down the vector.

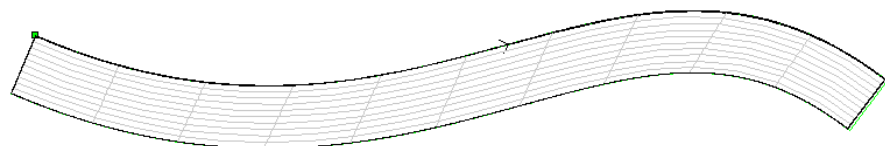

**Centred** – Click to select this option if you want to position the centre of the distortion envelope along the selected vector object.

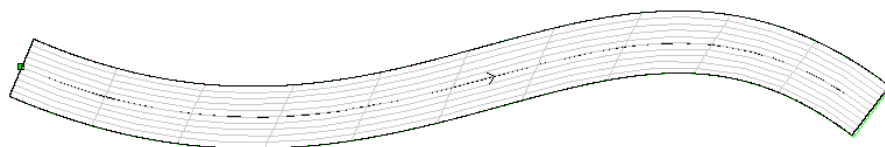

If you want to specify the width of the distortion envelope, click to select the **specify envelope width** option  and then define its width in the **Width** box. Its length is always equal to that of the selected vector object.

If you want to use two curved vector objects:

- First, click to select the **Wrap between 2 curves** radio button . The **Wrap along single curve** settings are greyed-out.
- Next, click to select the curved vector object shown in the **2D View** that you want to use as the top edge of the distortion envelope, and then click on the **Select Top Curve...** button.

An arrow appears on the selected vector object indicating the direction in which the distorted vector object will be positioned along it. The Start Point is shown in green.

- Finally, click to select the curved vector object shown in the **2D View** that you want to use as the bottom edge of the distortion envelope, and then click on the **Select Bottom Curve...** button.

An arrow appears on the selected vector object indicating the direction in which the distorted vector object will be positioned along it. The Start Point is shown in green.

5. In the **Number of Copies** area, define the number of copies of the distorted vector object that you want to create:
  - If you want to stretch the distorted vector object along the length of the selected vector object(s), click to select the **One - Stretch to Fit** radio button .
  - If you want ArtCAM Pro to calculate the optimum number of copies of the distorted vector object that should be created along the selected vector object(s), click to select the **Many - Best Fit** radio button .
  - If you want to create a specific number of copies of the distorted vector object along the selected vector object(s), click to select the **Many - Specific number of copies** radio button  and then define the number of copies in the **Copies** box.
6. Click on the **Apply** button to position the distortion envelope about the selected curved vector object(s). The distortion envelope is divided into sections equal to the number of copies of the distorted vector object you want to create.

7. Click on the **Paste** button to confirm the vector object's new shape.

If you do not want to paste the distorted vector object, click on the **Cancel** button.

In our example, the block of vector text appears as follows after manipulating the distortion envelope:

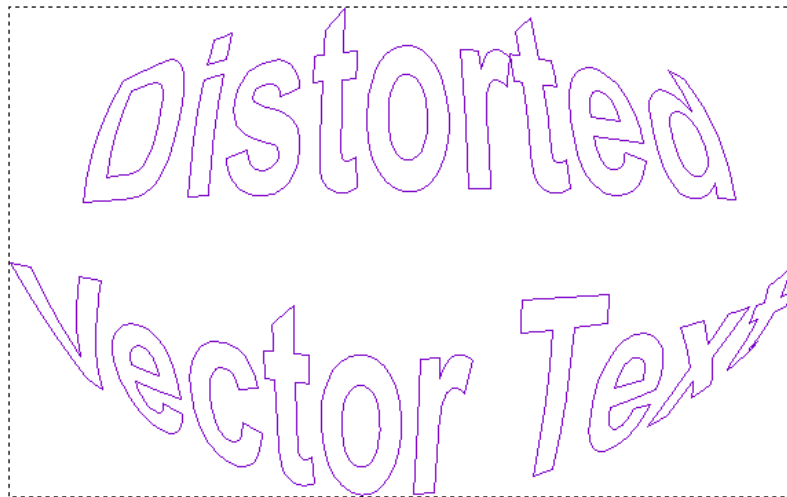

8. Click on the **Finish** button to return to the **Assistant's** Home page.



## ***Editing Distorted Vectors***

You can edit the distortion that you have applied to a vector object or vector text.

To continue distorting a vector object to which distortion settings have already been applied:

1. Make sure that you are in **Select Vectors** mode . For details, see "Selecting Vectors" on page 172.
2. Move the cursor over the distorted vector, and then use either of the following methods to display the **Envelope Distortion** page in the **Assistant** window:
  - Right-click to display the Vector Editing menu, and then click on the **Edit Envelope Distortion** option.
  - Press the **E** key on your keyboard.
3. In the **Editing Mode** area, select the mode you want to use to manipulate the distortion envelope:



- Click on the **Edit Distortion Envelope Nodes** button  if you want to adjust the shape of the distortion envelope. For details, see "Editing Vector Spans" on page 175 and "Editing Vector Nodes" on page 182.
  - Click on the **Transform Envelope** button  if you want to move, resize, rotate or shear the distortion envelope. For details, see "Transforming Vector Objects" on page 9.
4. Click on the **Paste** button to confirm the vector object's new shape.
  5. Click on the **Finish** button to return to the **Assistant's** Home page.

## Pasting Vectors Along a Curve

You can paste copies of a selected vector object along another curved vector object within a model.

To do so:

1. Hold down the **Shift** key on your keyboard, and then click on the vector object that you want to copy, followed by the curved vector object that you want to paste copies along. For details, see "Selecting Vectors" on page 172.
2. Click on the **Paste Along A Curve** button  in the **Vector Editing** area of the **Assistant's** Home page to display the **Paste Along A Curve** page.



---

**Note:** You can also display the **Paste Along A Curve** page from the Main menu bar by clicking on the **Vectors** menu, followed by the **Paste Vector(s) on Curve...** option.

---

3. Select the pasting method that you want to use:
  - Click on the **Specify Number** radio button , and then define the number of copies you want to create in the **Number of Copies** box.
  - Click on the **Specify Distance** radio button , then set the distance between each of the copies in the **Distance Between Copies** box.

4. If you want to make the spacing between the copies even, click to select the **Make Spacing Even** option .
5. Click on the **Paste** button to produce the copies along the selected curved vector object.

For example, the following image shows five copies of a star shaped vector object pasted evenly along a curved vector object:

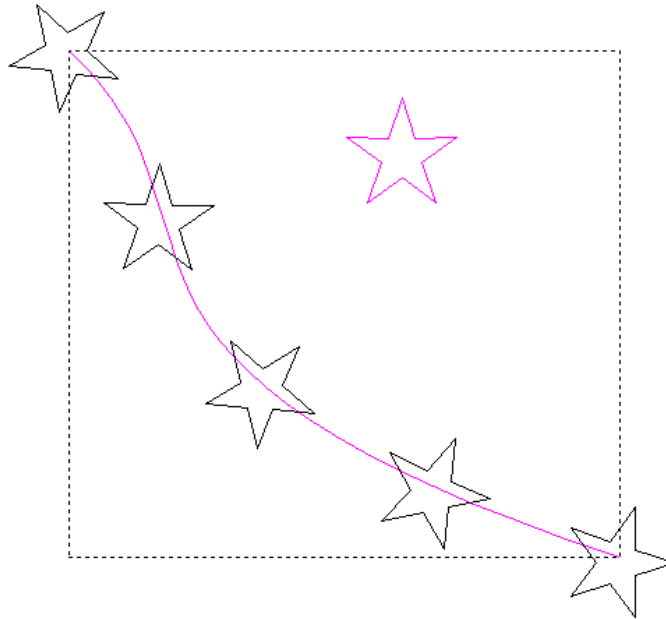

6. Click on the **Close** button to return to the **Assistant's** Home page.

## Converting Vector Objects

You can convert all or a selection of vector objects to either circles or rectangles of a defined size.

If you are converting a grouped selection of vector objects, each group is converted to a single shape. If you are converting an ungrouped selection of vector objects, each individual vector object is converted to an individual shape.

To convert a selection of vector objects to either circles or rectangles:

1. In the **2D View** window, select the vector objects that you want to convert to either circles or rectangles. For details, see "Selecting Vectors" on page 172.
2. From the Main menu bar, click on the **Vectors** menu and then on the **Convert To...** option to display the **Convert To Shapes** page.

3. If you want to convert the selected vector objects to circles:

- In the **To Circles** area, select either of the available conversion methods:

Click on the **From Original** radio button  if you want to convert the selected vector objects to circles of the same size as the original shape; or

Click on the **Specify** radio button  if you want to convert the selected vector objects to circles with a diameter equal to that which you define in the **Diameter** box.

- Next, click on the **To Circles** button to convert the selected vector objects to circles.

If you want to convert the selected vector objects to rectangles:

- In the **To Rectangles** area, select either of the available conversion methods:

Click on the **From Original** radio button  to convert the selected vector objects to rectangles of the same size as the original shape; or

Click on the **Specify** radio button  to convert the selected vector objects to convert the selected vector objects to rectangles with dimensions equal to that which you define in the **Height** and **Width** boxes.

- Next, click on the **To Rectangles** button to convert the selected vector objects to rectangles.

4. Click on the **Close** button to return to the **Assistant's** Home page.

## Creating a Vector Border

You can create a rectangular vector border around a selection of vector objects. You can define the width of the border around the X and Y-axis.

You can edit the vector border as you would any other square or rectangle created in ArtCAM Pro. For details, see "Editing a Square or Rectangle" on page 157.

To create a rectangular vector border around a selection of vector objects:

1. Make sure that you are in **Select Vectors** mode . For details, see "Selecting Vectors" on page 172.
2. In the **2D View** window, select the vector objects around which you want to create a vector border.
3. From the Main menu bar, click on the **Vectors** menu and then on the **Create Border...** option to display the **Create Border** page.
4. Define the width of the vector border in the **Gap In X** and **Gap In Y** boxes.
5. Click on the **Create Border** button to create the vector border.
6. Click on the **Close** button to return to the **Assistant's** Home page.

## Using the Vector Doctor

In previous versions of ArtCAM Pro, you would have to manually find and edit a range of common problems within vector artwork, often detrimental to the machining process, to correct them. You can now avoid problems during the manufacturing process by:

- Identifying all coincident points (nodes) in the vector objects that make up the artwork, within a specified tolerance, so that they can be joined using the **Join Vectors with Coincident Start or End Points** tool. For details, see "Identifying Coincident Points" on page 226.
- Identifying all loops in self-intersecting vector objects within the artwork less than a defined size, and then removing them. For details, see "Loop Detection and Removal" on page 227.

### *Identifying Coincident Points*

You can instruct ArtCAM Pro to check for concurrent start or end points (nodes) in a selection of open vector objects, within a defined distance of one another:

To identify the coincident points in your vector artwork:

1. Make sure that you are in **Select Vectors** mode . For details, see "Selecting Vectors" on page 172.

2. Click and drag around the vector artwork in the **2D View** window, or an area within it, to select it. All grouped vector objects within the selection turn purple; all ungrouped vector objects turn magenta.
3. Click on the **Vector Doctor** button  in the **Vector Editing** area to display the **Vector Doctor** page.



---

**Note:** You can also display the **Vector Doctor** page from the Main menu bar by clicking on the **Vectors** menu, followed by the **Vector Doctor...** option.

---

4. In the **Identify Problems** area, make sure that the **Coincident Points** option is selected .
5. If you only want ArtCAM Pro to recognise points in the selected vector object within a specific distance of one another as coincident, define the distance in the **Tolerance** box.
6. Click on the **Identify** button. ArtCAM Pro marks all coincident points in the selected vector object with the  icon.
7. Click on the **Close** button to return to the **Assistant's** Home page.

## ***Loop Detection and Removal***

Looped self-intersections found within vector artwork intended for engraving often cause problems during the manufacturing process.

You can instruct ArtCAM Pro to identify all loops within a selection of vector objects less than a defined size, inserts a point (node) at the bottom of the loop where the vector objects self-intersect, and then trim away the loop.

For example, the 'g' character shown below includes a self-intersecting vector object with a loop. You can see the difference in its shape after the loop has been removed:

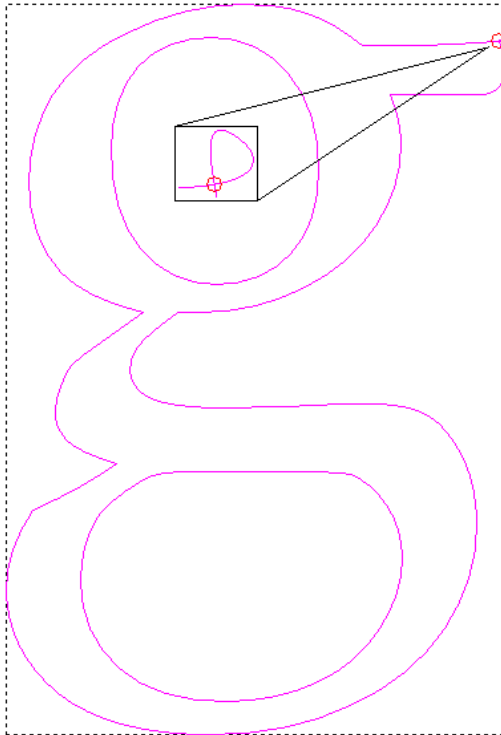

*Looped Vector Objects Before...*

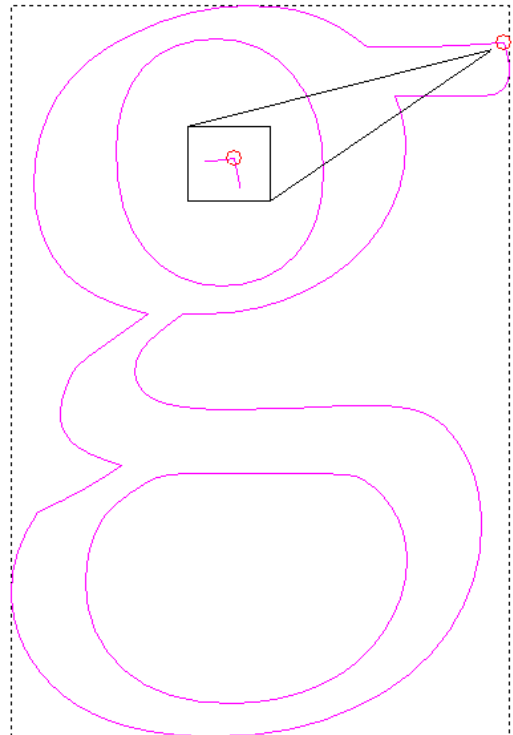

*Looped Vector Objects After...*



To remove the loop in self-intersecting vector objects:

1. Make sure that you are in **Select Vectors** mode . For details, see "Selecting Vectors" on page 172.
2. Hold the **Shift** key down on your keyboard, and then click to select all self-intersecting vector objects in the vector artwork shown in the **2D View** window. A self-intersecting vector object is shown in red. The selected vector objects turn purple.
3. Click on the **Vector Doctor** button  in the **Vector Editing** area to display the **Vector Doctor** page.
4. In the **Identify Problems** area, make sure that the **Vector Intersections** option is selected .
5. Click on the **Identify** button. ArtCAM Pro marks all intersections in the selected vector object(s) with the  icon.
6. If you want to clear all of these icons from the **2D View** window, click on the **Clear Markers** button.
7. In the **Remove Vector Loops** area, you can define the size of loops that you want ArtCAM Pro to ignore as a percentage of the overall size of the selected vector in the **% Of Vector Area To Keep Loop** box.

For example, if your vector artwork contains a figure 8, it is likely that you will want to keep both of its loops. If the original vector object has an area of 100 mm<sup>2</sup> and contains a loop of 1.5 mm<sup>2</sup>, a value of 1% would mean that the loop would be converted into an independent vector. A value of 2%, however, would mean that the loop would be deleted.

8. Type the name of the layer onto which you want to create the corrected vector object(s) in the **Layer Name** box. If no layer is defined, ArtCAM Pro creates the corrected vector object(s) on the currently selected layer.
9. If you want to keep a copy of the looped, self-intersecting vector object(s), make sure that the **Keep Originals** option is selected .
10. Click on the **Remove Loops** button to remove all loops in the selected vector object(s).
11. Click on the **Close** button to return to the **Assistant's** Home page.



---



**Note:** You can also press the **Ctrl + Alt + Shift + R** keys on your keyboard to remove all loops in the selected vector object(s).

---

---

## Working with Vector Text



You can create and manipulate vector text using three tools in ArtCAM Pro. These are:

- The **Font Editor** icon  on the **Assistant's Getting Started** page. For details, see "Using the Font Editor" in the Working with Models chapter.
- The **Create Vector Text** button  in the **Vector Editing** area of the **Assistant's** Home page. For details, see "Creating Vector Text" on page 230.
- The **Wrap Text Round a Curve** button  in the **Position Size Align Vectors** area of the **Assistant's** Home page. For details, see "Wrapping Text Round a Curve" on page 238.

## Creating Vector Text

You can create vector text with ease. Creating vector text in ArtCAM Pro is similar to typing text in most word processing packages. You can type in glyph (closed vector) or single-stroke (open vector) fonts.

To create vector text:

1. Click on the **Create Vector Text** button  in the **Vector Editing** area of the **Assistant's** Home page to display the **Text Tool** page.
2. Select the formatting for the text using the options on the **Text Tool** page. For details on the different options available, see "Formatting Vector Text" on page 233.
3. Move the  cursor over to the **2D View** window and click where in the model (the white area) you want to create the vector text. A text box appears in the **2D View** window and the mouse cursor changes to .
4. Type the vector text you want to create. It is useful to remember the following keystrokes when typing in vector text:
  - Press the **Enter** key on your keyboard to start a new line of vector text.
  - Press the **Backspace** key on your keyboard to delete the last character typed.
5. Click on the **Done** button or press both the **Ctrl + Enter** keys to create the vector text and return to the **Assistant's** Home page.

By default, the block of vector text is purple, indicating that the vector objects that make up the text are grouped. A bounding box also surrounds the block:



---

**Note:** You can move the block of vector text if you position the cursor over it, and then click and drag it into its new position.

---



## Selecting Vector Text

You can select vector text whilst the **Text Tool** page is displayed using either of the following methods:

- Click and drag over the character or block of vector text that you want to select; or
- Hold the **Shift** key down on your keyboard, and then use the arrow keys on the keyboard to control your selection.

The selected vector text is white and is highlighted in black:



---

**Note:** If you have selected a block of vector text containing more than one style of font, script and/or size, the relative list boxes in the **Style** area are blank.



---

When you have created the vector text, you can select it using the method described in "Selecting Vectors" on page 172.

## Editing Vector Text

Text editing refers to making changes in vector text, such as adding and deleting, or copying and pasting individual characters or blocks of vector text.

Using the editing buttons in the **Style** area, you can cut, copy and paste a selected character or block of vector text when the **Text Tool** page:

- Click on the **Cut** button  to remove the selected vector text and place it on the clipboard.
- Click on the **Copy** button  to create a duplicate of the selected vector text and place it on the clipboard.
- Click on the **Paste** button  to place a copy of the vector text, overlaying any currently selected text.



---

**Note:** If you copy a block of vector text that contains multiple fonts, when you use the **Paste** button  the vector text is written in the font currently selected on the **Text Tool** page.

---



---

**Note:** A selected block of vector text that has already been transformed, e.g. sheared, appears as a default block whilst the **Text Tool** page is displayed. After closing the page, the transform is restored and any changes that you have made to the text are applied.

---

You can use either of the following methods to edit a selected character or block of vector text after it has been created:

- Right-click on the block of vector text to display the Text Editing menu, and then click on the **Edit Text Block** option to display the **Text Tool** page.
- Press the **E** key on your keyboard to display the **Text Tool** page.

You can also cut, copy and/or paste a block of vector text after it has been created using the editing buttons in the **File** area of the **Assistant's** Home page. For details, see "Copying and Pasting Vector Objects" on page 192.

You can add or delete characters when the **Text Tool** page is displayed in the **Assistant** window using your keyboard:

- Use the character keys on your keyboard to add characters to the block of vector text.
- Press the **Backspace** key on your keyboard to delete the last typed character.

You can delete a selected block of vector text when the **Text Tool** page is not displayed in the **Assistant** window using either of the following ways:

- Move the cursor over the block of vector text, and then press the **Delete** key on your keyboard.
- Right-click on the selected block of vector text to display the Vector Editing menu, and then click on the **Delete** option.

## Formatting Vector Text



Text formatting refers to setting the way vector text looks using different fonts, bold or italic type, indents and alignments.

You can format a character or block of vector text both during and after its creation using the formatting buttons and the list boxes in the **Style** area of the **Text Tool** page.

You can use the formatting buttons as follows:



- Click on the **Toggle Vertical Text Flow** button  to display vector text vertically, rather than horizontally.

When the **Toggle Vertical Text Flow** button  is selected, the **Kerning** options are removed from the **Text Tool** page and the alignment buttons are adjusted.

- Click on the **Bold** button  to make the vector text bold, or to remove the bold formatting.
- Click on the **Italic** button  to make the vector text italic, or to remove the italic formatting.
- Click on the **Align Left** button  to align the selected vector text to the left of the text box with a ragged right edge. This button affects selected vector text of more than one line.



---

**Note:** If the **Toggle Vertical Text Flow** button  is selected, the **Align Top** button  replaces the **Align Left** button , allowing you to align the vector text with the top of the text box with a ragged bottom edge.

---

- Click on the **Centred** button  to place the selected vector text in the centre of the text box. This button affects vector text of more than one line.



---



**Note:** If the **Toggle Vertical Text Flow** button  is selected, the icon for the **Centered** button  is rotated .

---

- Click on the **Align Right** button  to align the selected vector text to the right of the text box with a ragged left edge. This button affects selected vector text of more than one line.



---

**Note:** If the **Toggle Vertical Text Flow** button  is selected, the **Align Bottom** button  replaces the **Align Right** button , allowing you to align the vector text with the bottom of the text box with a ragged top edge.

---

To change the font you are using:

- Click on the **Font** list box, and then click on the font required. In the **Font** list box, you can see a preview of the font style before it is selected.

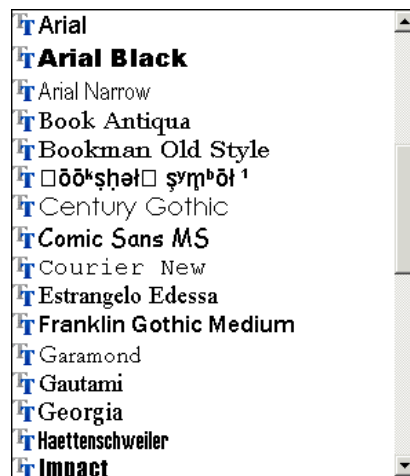

---

**Note:** You can type in glyph (closed-vector) or single-stroke (engraving) fonts. All single-stroke fonts and fonts created using the **Font Editor** are listed with an '(AFN)' prefix in the **Font** list box. For further information, see "Using the Font Editor" in the Working with Models chapter.

---

To change the size of the font you are using:

- Define the font size in the **Size** box. You can also change the units of measurement by clicking on any of the three options in the list box to the right: *points*, *mm*, or *inches*.

You can also use the the ▲ or ▼ arrows beside the **Size** box to set the font size:

- When **points** is selected, each click on the ▲ arrow increases the font size by 3 points by default, while each click on the ▼ arrow decreases the font size by 3 points.
- When **mm** is selected, each click on the ▲ arrow increases the font size by 1 mm by default, while

each click on the ▼ arrow decreases the font size by 1 mm.

- When **inches** is selected, each click on the ▲ arrow increases the font size by 0.04 inches by default, while each click on the ▼ arrow decreases the font size by 0.04 inches.



---

**Note:** You can set the default increments used on the **Text Tool** and **Text on a Curve** pages using the **ArtCAM Options** page. For details, see "Managing ArtCAM Pro's Preferences" in the ArtCAM Pro Layout chapter.

---

To change the script you are using:

- Click on the **Script** list box, and then on the required script.

To scale a character or block of vector text:

- In the **Resize** area, define the percentage by which you want to scale the text as you type, or apply to the currently selected vector text, along the X and Y axes in the **%(X)** and **%(Y)** boxes.

You can also use the the ▲ or ▼ arrows beside the **%(X)** and **%(Y)** boxes to set the percentage by which you want to scale the text as you type, or apply the currently selected text.

For example, vector text set at 12 mm scaled to 75% in both the X-axis and 75% in Y-axis appears something like this:

vector text

To adjust the angle of a character or block of vector text:

- Define the angle at which you want to type, or apply to the currently selected vector text, in the **Angle** box.



---

**Note:** If you are typing in italics, the vector text will have an angle even if no value or a 0 is in the **Angle** box. You can use negative values to tilt the vector text in the opposite direction.

---

You can also use the the ▲ or ▼ arrows beside the **Angle** box to set the angle at which you want to set the text as you type, or apply the currently selected text.

For example, vector text with an angle of 45° appears something like this:



To rotate a character or block of vector text:

- Define the angle at which you want to rotate the vector text as you type, or apply to the currently selected vector text, in the **Rotation** box. Each character is rotated around the centre of the area defined by its width, and both the ascent and descent of the current font.

You can also use the the ▲ or ▼ arrows beside the **Angle** box to set the angle by which you want to rotate the text as you type, or apply the currently selected text.

For example, vector text rotated at an angle of 18° appears something like this:



You can use either of the following methods to adjust the amount of white space on either side of a character in a block of vector text:

- Define the distance you want to place between each character using the **Character** box.
- Click and drag on the **% of space** slider to adjust the value in the **Character** box.

To adjust amount of white space between lines in a block of vector text:

- Define the distance you want to place between each line in the **Line** box.



You can also use the the ▲ or ▼ arrows beside the **Line** box to set the distance between each line within a block of vector text.

**Kerning**, like **Spacing**, applies white space on either side of a character in a block of vector text. Kerning, however, considers the shape of the previous character in relation to the character that is being typed, and adjusts the distance between them so that their fit looks good.

To adjust the kerning between all the characters in a block of vector text:

1. In the **Kerning** area, click on the **Mode** list box and select how you want to apply kerning to the vector text:
  - If you want ArtCAM Pro to automatically apply kerning to newly created or edited text, click on the **Auto** option.
  - If you want to manually apply kerning to a selected block of vector text, click on the **Manual** option.
2. Define the amount of kerning that you want to apply to a selected block of vector text. To do so, you can either:
  - Define the amount of kerning in the **Kerning** box.
  - Click and drag on the **% of space** slider to adjust the value in the **Kerning** box.
3. If you want to apply ArtCAM Pro's default kerning settings to a selected block of vector text, click on the **Default Kerning** button.

The **Constraints** area allows you to apply a bounding box to a block of vector text. By enclosing vector text in a bounding box, you can align its characters in different ways, and apply constraints to the text when typing. The alignment methods are as follows:

- Click on the **Align Top** button  to align the vector text with the top of the bounding box.
- Click on the **Centered** button  to position the vector text in the centre of the bounding box.
- Click on the **Align Bottom** button  to align the vector text with the bottom of the bounding box.

You can control how the bounding box is used to constrain the vector text:

1. Click on the **Method** list box, and then select any of the constraining methods:



---

**Note:** If you are creating vector text within a selected vector object, the vector object will be used to constrain the vector text according to the method selected from the list box.

---

- **None** – This option allows you to type according to the size of the vector text as defined in the **Size** box without using a bounding box.

- **Limit by Box** – This option allows you to type vector text at the size defined in the **Size** box, until it reaches the edge of the bounding box. After reaching its edge, the vector text continues to reduce in size as you type, so that all characters can be contained within the bounding box.
  - **Scale to Box** – This option scales the vector text as you type, so that it fills as much of the area defined by the bounding box as possible.
2. If you want to set the dimensions of the bounding box:
    - Define the width and height of the bounding box in the **Width** and **Height** boxes.



---

**Note:** If you have applied a constraint setting to one or more characters in a block of vector text and the **Constraints** settings are not displayed on the page, these are displayed when the cursor moves over that character.

---

## Wrapping Text Round a Curve

ArtCAM Pro allows you to place vector text on or around any open or closed curved vector object.

Before you wrap a block of vector text around a curve, you must draw both the curved vector shape and some vector text.

To wrap vector text around a curved vector:

1. Select the curved vector object around which you want to wrap vector text. For details, see "Selecting Vectors" on page 172.
2. Hold down the **Shift** key on your keyboard, and then click to select the block of vector text you want to wrap. A bounding box surrounds the selected vector objects.
3. Click on the **Wrap Text Round a Curve** button  in the **Position Size Align Vectors** area of the **Assistant's** Home page.

If you are attempting to wrap imported vector text created in another package, or vector text that is ungrouped, the following message box appears:



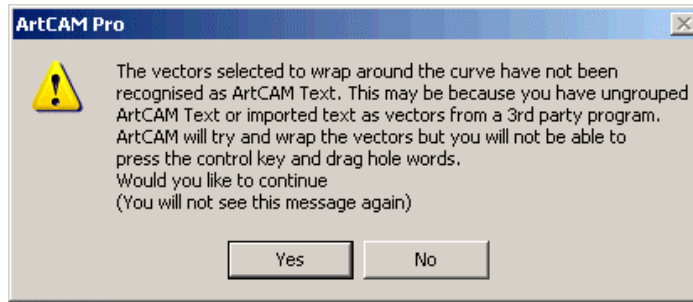

If you want ArtCAM Pro to attempt to wrap the vector text, click on the **Yes** button. The message box closes.



---

**Warning:** Although you can wrap imported vector text created in another package, or an ungrouped block of vector text created in ArtCAM around a curved vector object, you cannot reposition whole words using the click and drag method detailed in this section. You can drag individual letters into position, and use the **Text Settings** options on the **Text on a Curve** page, but the results may not always be accurate and unwanted copies of the text may remain in your vector artwork.

---

If you want to abort the wrapping of the text around the curve, click on the **No** button. The message box closes.

If the vector text was created in ArtCAM Pro, you can now wrap the vector text around the curved vector object.

4. Click on the **Select** button to wrap the vector text around the selected vector object. You can reposition the block of vector text using either of the following methods:
  - Click and drag the vector text along the curve.
  - Use the **Text Settings** on the **Text on a Curve** page. For details, see "Using the Text Settings" on page 239.

## ***Using the Text Settings***

You can select the text's position, alignment and spacing using the options in the **Text Settings** area of the **Text on a Curve** page.

### **Text Position**

You can position the vector text on a curve in several ways using the **Text Position** options as follows:

- Click on the **Above Line** radio button  to position the vector text just above the curve:

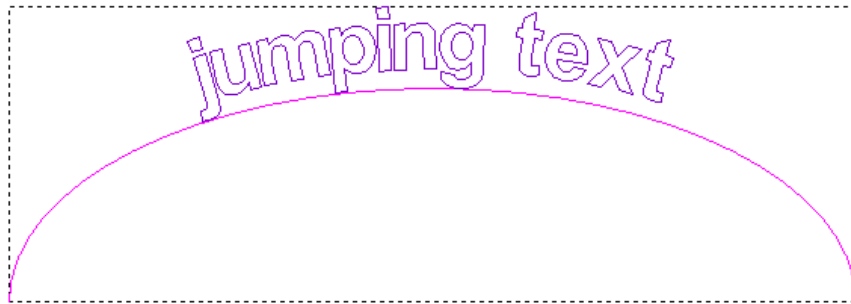

- Click on the **Base Line** radio button  to position the base of the vector text directly on the curve:

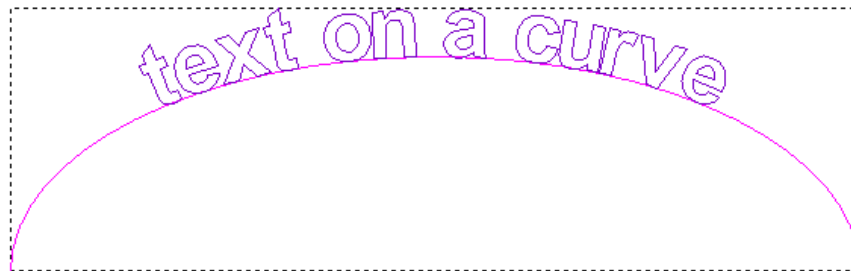

- Click on the **Centre On Ascent** radio button  to position the ascending part of the characters in the vector text on the curve:

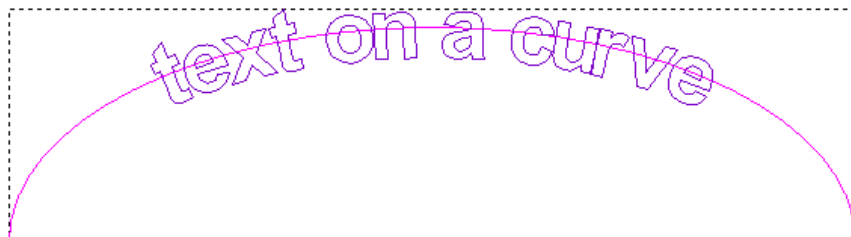

- Click on the **Centre On Strikeout** radio button  to position the vector text so that the curve is used as strikeout through the middle of the vector text:

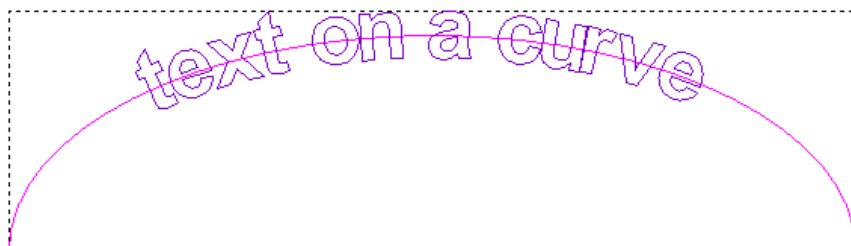

- Click on the **Below Line** radio button  to position the vector text below the curve:

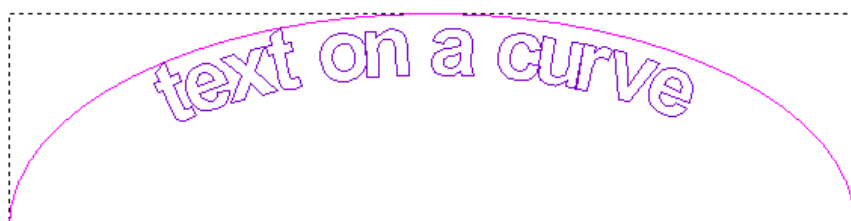

- Click on the **Specify** radio button , and then set the distance of the vector text from the curve using the adjacent box. To view the vector text at the specified distance, click on the **Update** button.

For example, defining a distance of -10 mm produces the following result:

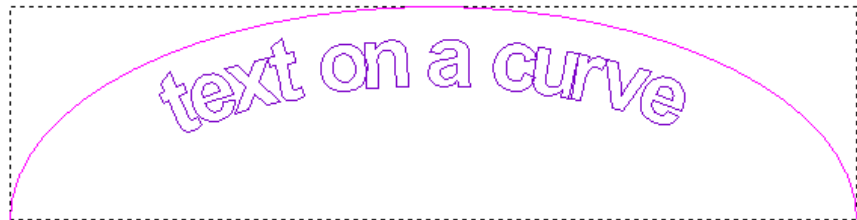

To reverse the direction of the curved vector object, click to select the **Text on other side** option .

**Text on other side** Off...

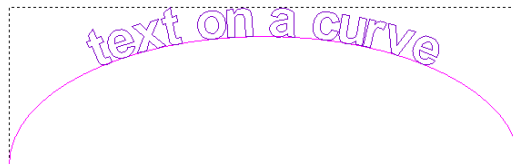

**Text on other side** On...

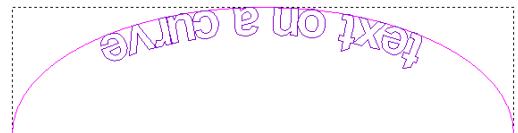

## Text Alignment

You can align vector text to a curve either vertically or perpendicularly. When aligning text perpendicular to a curve, random characters can overlap one another making it extremely problematic to machine them. You can sweep text around a curve to avoid this problem altogether. You can also stretch vector text around the length of a curve.

When using the **Text on a Curve** tool, you can use any of the following **Text Alignment** options:

- **Vertical** - Click on this radio button  to align the text vertical to the curve:

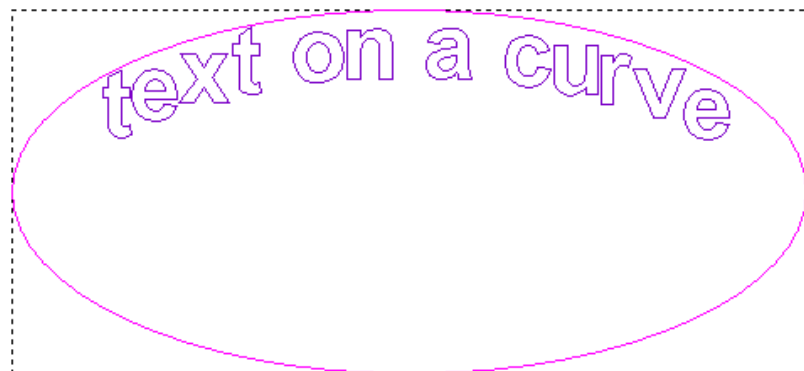

- **Align To Curve** - Click on this radio button  to align the text perpendicular to the curve:

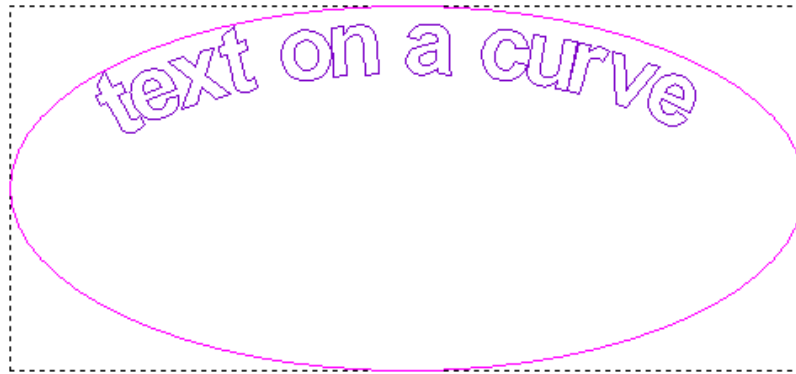

- **Sweep Around Curve** - Click on this radio button  to sweep the text around the curve. ArtCAM Pro distorts the original shape of characters by fitting arcs around them and then offsetting them from one another:

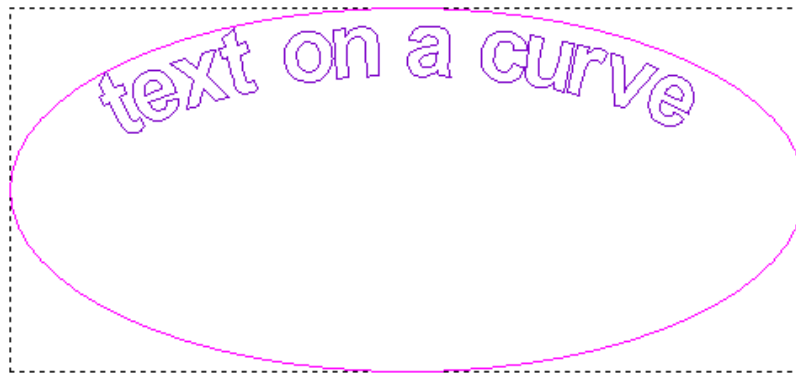

If we compare the word *text* when aligned and then when swept around a curve, we can see that the overlapping 't' and 'e' characters that occurs when aligning is avoided when the text is swept around the curve:

*Align To Curve...*

*Sweep Around Curve...*



- If you want to stretch the characters within the block of vector text around the length of the curve, click to select the **Stretch To Curve** option :

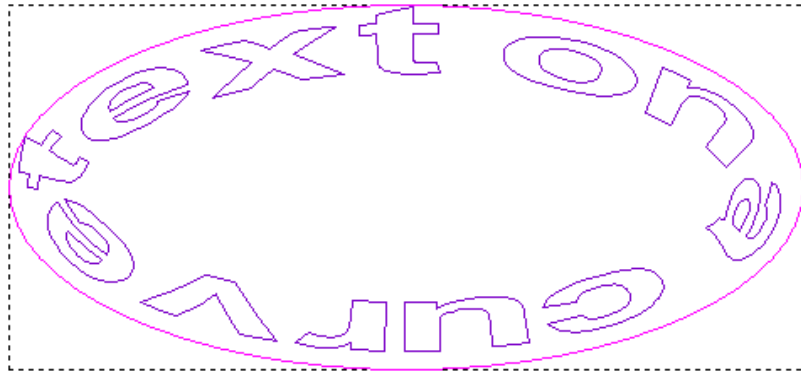

## Text Spacing

You can set the distance between characters within a block of vector text using the **Text Spacing** slider.

Click the slider and drag to set the spacing. Drag to the right if you want to increase the spacing. Drag to the left to reduce it.

When you are satisfied with the spacing between the characters in the block of vector text, click on the **OK** button.

You can select what vector text you want to edit using the **Editing Style** options:

- **Whole Sentence** - Click on the radio button  to move all text into position on the curve.
- **Single Words** - Click on the radio button  to move a specific word into position on the curve.



---

**Note:** Alternatively, you can hold down the **Ctrl** key on your keyboard and then click and drag a specific word into place.

---

- **Single Letters** - Click on the radio button  to move a character into position on the curve.



---

**Note:** Alternatively, you can hold down the **Alt** key on your keyboard and then click and drag a specific character into place.

---

---

## Measuring Vector Objects

You can find out the size, position and angle of any vector object as follows:

1. Click on the **Measure Tool** button  in the **Vector Editing** area of the **Assistant's** Home page to display the **Measure** page.



---

**Note:** You can also display the **Measure** page by clicking on the **M** key on your keyboard.

---

2. Click on the position in the model from which you want to measure. This position is known as the **Anchor Point**.
3. Drag the mouse to the position to which you want to measure and then click.

ArtCAM Pro calculates the measurement details in real time and displays them on the **Measure** page as you drag the cursor into position.

By default, the cursor snaps to specific positions on the vector objects or guidelines that have been drawn. For further information, see "Snapping to Objects" in the ArtCAM Pro Layout chapter.



---

**Note:** To temporarily disable snapping, hold the **Shift** key down on your keyboard whilst dragging the cursor.

---

---

## Transforming Vector Objects

You can transform a vector object directly from the **2D View** window, or when the **Transform Vector(s)** page is displayed in the **Assistant** window.

### Using Transform Vectors Mode

To transform a vector object directly from the **2D View** window, you must work in Transform Vectors mode.

To transform a vector object directly from the **2D View** window:

1. Select the vector object that you want to transform. For details, see "Selecting Vectors" on page 172.
2. Use either of the following methods to enter Transform Vectors mode:
  - Press the **T** key on your keyboard.
  - Hold the **Ctrl** key down on your keyboard, and then click on the selected vector object until transform

handles appear on the bounding box that surrounds it.

The **Transform Vector(s)** button changes to . Resizing handles, a rotation handle and shearing control points are displayed about the selected vector object.



---

**Note:** If you click outside of the bounding box that surrounds the selected vector object once, ArtCAM Pro remains in Transform Vectors mode. If you click more than once, ArtCAM Pro returns to Select Vectors mode.

---

When working in Transform Vectors mode, you can transform the selected vector object in the following ways:

- To move the vector object, move the cursor over its centre, one of its spans or its bounding box, and then click and drag it into position.



---

**Note:** Hold down the **Ctrl** key on your keyboard to keep a copy of the selected vector object in its original position when moving it.

---

- To adjust the size and shape of the vector object, move the cursor over any of its resizing handles, and then click and drag.



---

**Note:** Hold down the **Shift** key on your keyboard when scaling to preserve the ratio between the vector object's width and height.

---



---

**Note:** Hold down the **Alt** key on your keyboard when scaling to scale the selected vector object about the centre of its bounding box.

---

- To adjust the angle of the vector object, click and drag the rotation handle joined to its centre of gravity.
- To shear the vector object vertically, move the cursor over the control point outside of the bottom edge of the bounding box, and then click and drag.
- To shear the vector object horizontally, move the cursor over the control point outside of the right edge of the bounding box, and then click and drag.



---

**Note:** If you want to transform the selected vector object about a defined origin and/or using specific values, press the **T** key on your keyboard again to display the **Transform Vector(s)** page in the **Assistant** window. For details, see "Using the Transform Vector(s) Page" on page 246.

---

## Using the Transform Vector(s) Page

You can use the **Transform Vector(s)** page to transform a selected vector object in a number of ways.

To display the **Transform Vector(s)** page:

1. Select the vector object that you want to transform. For details, see "Selecting Vectors" on page 172.
2. Click on the **Transform Vector(s)** button  in the **Vector Editing** area of the **Assistant's** Home page.



---

**Note:** Alternatively, you can press the **T** key on your keyboard twice to display the **Transform Vector(s)** page.

---



---

**Note:** You can also display the **Transform Vector(s)** page from the Main menu bar by clicking on the **Vectors** menu and then on the **Transform...** option.

---



---

**Note:** You can also display the **Transform Vector(s)** page if you right-click on the selected vector object to display the Vector Editing menu, and then click on the **Transform Vector(s)...** option

---

The **Transform Vector(s)** page is divided into the following areas:

- **Position and Origin** - This allows you to define the origin about which the selected vector object is transformed. For details, see "Defining the Transform Origin" on page 247
- **Size** - This allows you to change the size of the selected vector object. For details, see "Scaling Vectors" on page 248.
- **Rotate** – This allows you to spin a selected vector object around the model's X and Y-axes. For details, see "Rotating Vectors" on page 250.





- **Move** – This allows you to move a selected vector object along the X and Y-axis. For details, see "Moving Vectors" on page 251.
- **Shear** - This enables you to shear a selected vector object. For details, see "Shearing Vectors" on page 253.

## ***Defining the Transform Origin***

You can transform a selected vector object relative to a defined origin using the **Position and Origin** area of the **Transform Vector(s)** page.

To define the origin by which you want to reposition, resize or rotate a selected vector object:

1. Select the vector object that you want to transform. For details, see "Selecting Vectors" on page 172.
2. Click on the **Transform Vector(s)** button  in the **Vector Editing** area to display the **Transform Vector(s)** page in the **Assistant** window.
3. The co-ordinates in the **X** and **Y** boxes show the current position of the transform origin. Define the new origin about which you want to transform the selected vector object in any of the following ways:
  - Click on any of the five radio buttons  on the rectangle diagram to set the origin to one of five pre-set positions. The co-ordinates of the selected position are displayed in the **X** and **Y** boxes.
  - Define the X and Y co-ordinates of the position you want to set as the origin in the **X** and **Y** boxes.
  - Click to select the **Transform about (x,y)** option . The default **X** and **Y** boxes are greyed-out and new **X** and **Y** boxes are displayed on the page. The **+** icon appears in the **2D View** window, marking the current position of the transform origin.

To set the origin you can either define its X and Y co-ordinates in the **X** and **Y** boxes or move the **+** cursor to the position in the **2D View** window that you want to use, and then click to select. In the latter instance, the co-ordinates of the selected position are displayed in the **X** and **Y** boxes.

4. Click on the **Apply** button to define the transform origin.  
You can now transform the selected vector object about this origin.

## Scaling Vectors

You can change the size of a vector object using the **Size** area of the **Transform Vector(s)** page in the following ways:

- Using specific measurements.
- Using the slider.
- Using a percentage of its original size.

To change the size of a vector object using specific measurements:

1. Select the vector object that you want to resize. For details, see "Selecting Vectors" on page 172.
2. Click on the **Transform Vector(s)** button  in the **Vector Editing** area to display the **Transform Vector(s)** page.
3. Make sure that the origin by which you want to resize the selected vector object is correct. For details, see "Defining the Transform Origin" on page 247.
4. If you want to preserve the ratio between the width and height of the selected vector object, make sure that the **Link Width and Height** option is selected . This option is selected by default.
5. Define the width of the selected vector object using the **New Width** box. If the **Link Width and Height** option is selected , the current value in the **New Height** box is adjusted. If the **Link Width and Height** option is deselected , you must define its height using the **New Height** box.



---

**Note:** If you want to keep a copy of the selected vector object in its original size, click to select the **Copy on Apply (Ctrl)** option  or hold down the **Ctrl** key on your keyboard when scaling.

---



---

**Note:** Hold down the **Shift** key on your keyboard when scaling to preserve the ratio between the vector object's width and height.

---



---

**Note:** Hold down the **Alt** key on your keyboard when scaling to scale the selected vector object about the centre of its bounding box.

---

6. Click on the **Apply** button to resize the selected vector object. The values shown in the **New Width** and **New Height** boxes are adjusted.
7. Click on the **OK** button to return to the **Assistant's** Home page.

To change the size of a vector object using the slider:

1. Select the vector object that you want to resize. For details, see "Selecting Vectors" on page 172.
2. Click on the **Transform Vector(s)** button  in the **Vector Editing** area to display the **Transform Vector(s)** page.
3. Make sure that the origin by which you want to resize the selected vector object is correct. For details, see "Defining the Transform Origin" on page 247.
4. If you want to preserve the ratio between the width and height of the selected vector object, make sure that the **Link Width and Height** option is selected . This option is selected by default.



---

**Note:** If the **Link Width and Height** option is deselected , only the width of the selected vector object can be adjusted using the slider.

---



---

**Note:** If you want to keep a copy of the selected vector object in its original size, click to select the **Copy on Apply (Ctrl)** option  or hold down the **Ctrl** key on your keyboard when scaling.

---

5. Click and drag the slider in the appropriate direction:
  - Drag to the right if you want to increase the size of the selected vector object.
  - Drag to the left if you want to reduce the size of the selected vector object.



---

**Note:** If you drag the slider without selecting the **Link Width and Height** option , only the value in the **New Width** box changes.

---

A preview image of the new size of the selected vector object appears in the **2D View** window.

6. Click on the **Apply** button to resize of the selected vector object.
7. Click on the **Close** button to return to the **Assistant's** Home page.

## Rotating Vectors

You can rotate a vector object in two ways using the **Rotate** area of the **Transform Vector(s)** page:

- Using a specific angle.
- Using the slider.

To rotate a vector object using a specific angle:

1. Select the vector object that you want to rotate. For details, see "Selecting Vectors" on page 172.
2. Click on the **Transform Vector(s)** button  in the **Vector Editing** area to display the **Transform Vector(s)** page.
3. Make sure that the origin by which you want to rotate the selected vector object is correct. For details, see "Defining the Transform Origin" on page 247.
4. Define the angle by which you want to rotate the selected vector object in the **Rotate** box:
  - A positive value rotates the selected vector object clockwise.
  - A negative value rotates the selected vector object anti-clockwise.



---

**Note:** If you want to keep a copy of the selected vector object in its original position, click to select the **Copy on Apply (Ctrl)** option  or hold down the **Ctrl** key on your keyboard when rotating.

---

5. Click on the **Apply** button to rotate the selected vector object by the defined angle.
6. Click on the **Close** button to return to the **Assistant's** Home page.

To rotate a vector object around the X and Y axes using the sliders:

1. Select the vector object that you want to rotate. For details, see "Selecting Vectors" on page 172.
2. Click on the **Transform Vector(s)** button  in the **Vector Editing** area to display the **Transform Vector(s)** page.
3. Make sure that the origin by which you want to rotate the selected vector object is correct. For details, see "Defining the Transform Origin" on page 247.
4. Click and drag the slider in the appropriate direction:
  - Drag to the right if you want to rotate the selected vector object clockwise.
  - Drag to the left if you want to rotate the selected vector object anti-clockwise.



---

**Note:** If you want to keep a copy of the selected vector object in its original position, click to select the **Copy on Apply (Ctrl)** option  or hold down the **Ctrl** key on your keyboard when rotating.

---

5. Click on the **Apply** button to rotate the selected vector object by the angle shown in the **Rotate** box.
6. Click on the **Close** button to return to the **Assistant's** Home page.

## ***Moving Vectors***

You can reposition a vector object in two ways using the **Move** area of the **Transform Vector(s)** page:

- Using specific co-ordinates.
- Using the sliders.

To move a vector object to a specific position:

1. Select the vector object that you want to move. For details, see "Selecting Vectors" on page 172.
2. Click on the **Transform Vector(s)** button  in the **Vector Editing** area to display the **Transform Vector(s)** page.
3. Make sure that the origin by which you want to move the selected vector object is correct. For details, see "Defining the Transform Origin" on page 247.

4. Define the co-ordinate to which you want to move the selected vector object along the X-axis in the **Move X** box.

A positive value moves the selected vector to the right, while a negative value moves it to the left.



---

**Note:** If you want to keep a copy of the selected vector object in its original position, click to select the **Copy on Apply (Ctrl)** option  or hold down the **Ctrl** key on your keyboard when moving.

---

5. Define the co-ordinate to which you want to move the selected vector object along the Y-axis in the **Move Y** box.  
A positive value moves the selected vector upwards, while a negative value moves it downwards.
6. Click on the **Apply** button to reposition the selected vector object.
7. Click on the **Close** button to return to the **Assistant's** Home page.

To move a vector object along the X and Y axes using the sliders:

1. Select the vector object that you want to move. For details, see "Selecting Vectors" on page 172.
2. Click on the **Transform Vector(s)** button  in the **Vector Editing** area to display the **Transform Vector(s)** page.
3. Make sure that the origin by which you want to move the selected vector object is correct. For details, see "Defining the Transform Origin" on page 247.
4. Click and drag the sliders in the appropriate direction:
  - Drag the **Move X** slider to the right if you want to move the selected vector object to the right.
  - Drag the **Move Y** slider to the right if you want to move the selected vector object upwards.
  - Drag the **Move X** slider to the left if you want to move the selected vector object to the left.
  - Drag the **Move Y** slider to the left if you want to move the selected vector object downwards.
5. Click on the **Apply** button to reposition the selected vector object.

6. Click on the **Close** button to return to the **Assistant's** Home page.

## Shearing Vectors

Shearing can be visualised by thinking of an image superimposed onto a flexible rubber sheet. If you hold the sides of the sheet and move them up and down in opposite directions, the image undergoes a spatial stretching known as shearing:

*Before Shearing...*

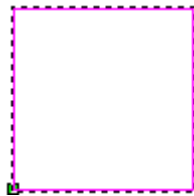

*After Shearing in the X-axis...*

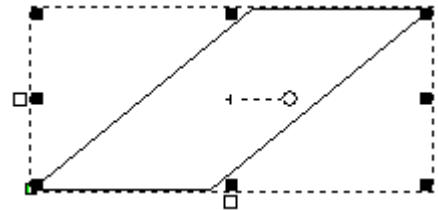

You can shear a vector object in two ways using the **Shear** area of the **Transform Vector(s)** page:

- Using specific angles.
- Using the sliders.

To shear a vector object using specific angles:

1. Select the vector object that you want to shear. For details, see "Selecting Vectors" on page 172.
2. Click on the **Transform Vector(s)** button  in the **Vector Editing** area to display the **Transform Vector(s)** page.
3. Define the angle by which you want to shear the selected vector object vertically in the **Shear X** box.
4. Define the angle by which you want to shear the selected vector object horizontally in the **Shear Y** box.
5. Click on the **Apply** button to shear the selected vector object.
6. Click on the **Close** button to return to the **Assistant's** Home page.

To shear a vector object along the X and Y axes using the sliders:

1. Select the vector object that you want to shear. For details, see "Selecting Vectors" on page 172.

2. Click on the **Transform Vector(s)** button  in the **Vector Editing** area to display the **Transform Vector(s)** page.
3. To shear the vector object vertically, click and drag the **Shear X** slider.



---

**Note:** If you want to keep a copy of the selected vector object in its original shape, click to select the **Copy on Apply (Ctrl)** option  or hold down the **Ctrl** key on your keyboard when shearing.

---

If you want to shear the vector object horizontally, click and drag the **Shear Y** slider.

4. Click on the **Apply** button to shear the selected vector object.
5. Click on the **Close** button to return to the **Assistant's** Home page.

---

## Manipulating Vector Objects

There is a range of tools in both the **Position Size Align Vectors** and **Group Merge Join Trim Vectors** areas of the **Assistant's** Home page designed to assist you in manipulating vector objects.

### Mirroring Vectors

Using the **Mirror Vectors** page, you can reverse the direction of a vector object from its original position.

To mirror a selection of vector objects:

1. Select the vector objects that you want to mirror. For details, see "Selecting Vectors" on page 172.
2. Click on the **Mirror Vectors** button  in the **Vector Editing** area of the **Assistant's** Home page to display the **Mirror Vectors** page.
3. If you want to produce mirrored copies and keep the original position of the selected vector objects, click to select the **Copy the Original Vectors (Ctrl)** option  or hold down the **Ctrl** key on your keyboard when mirroring.



4. Click on any of the options listed in the **Mirror Types** area of the page to mirror the selected vector object. For details, see "Using the Mirroring Options" on page 255.
5. Click on the **Close** button to return to the **Assistant's** Home page.

## Using the Mirroring Options

You can mirror a selected vector object horizontally, vertically or about a line.

You can use the options in the **Mirror Types** area of the **Mirror Vectors** page to mirror a vector object in the **Horizontal** plane in the following ways:

- **Left** - This option mirrors the selected vector objects in the horizontal plane about a point on the left edge of the selected vector objects:



- **Centre** - This option mirrors the selected vector objects in the horizontal plane about a point in the centre of the selected vector objects:



- **Right** - This option mirrors all your selected vector objects in the horizontal plane about a point on the right edge of the selected vector objects:

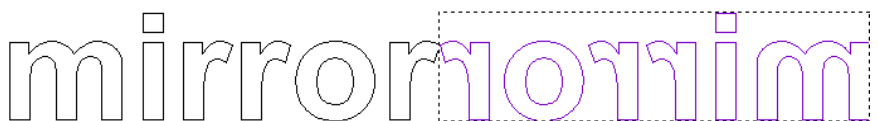

- **Top** - This option mirrors all your selected vector objects in the horizontal plane about a point on the top edge of the selected vector objects:

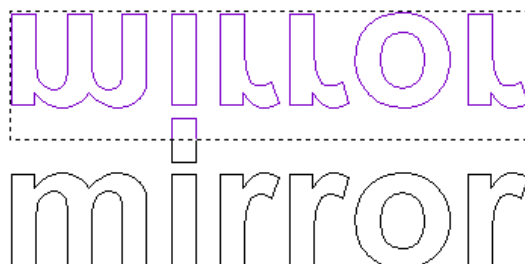

- **Centre** - This option mirrors the selected vector objects in the vertical plane about a point in the centre of the selected vector objects:

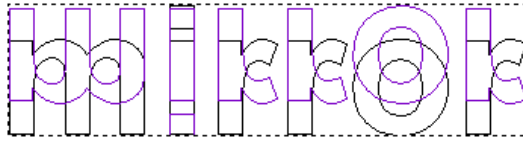

- **Bottom** - This option mirrors the selected vector objects in the horizontal plane about a point on the bottom edge of the selected vector objects:

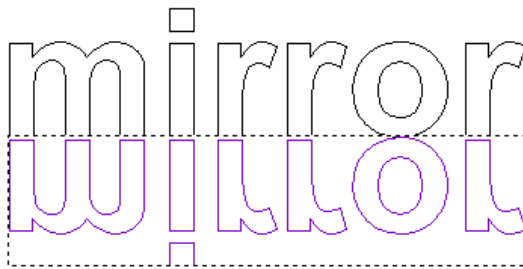

You can also mirror a selected vector object about an open vector object, such as a polyline, using the **About Line** option on the page:

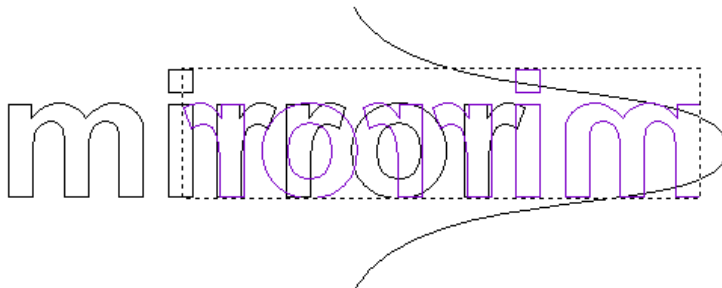

To mirror a vector object about an open vector object:

1. Select the open vector object about which you want to mirror a vector object. For details, see "Selecting Vectors" on page 172.
2. Hold the **Shift** key down on your keyboard, and then click to select the vector object that you want to mirror.
3. Click on the **Mirror Vectors** button  in the **Vector Editing** area of the **Assistant's** Home page to display the **Mirror Vectors** page.
4. Click on the **About Line** option on the **Mirror Vectors** page.



---

**Note:** If you want to mirror the selected vector object about the selected open vector object and keep a copy in its original position, click to select the **Copy the Original Vectors (Ctrl)** option  or hold down the **Ctrl** key on your keyboard when mirroring.

---

5. Click on the **Close** button to return to the **Assistant's** Home page.

## Aligning Vectors

You can position two or more vector objects relative to one another in different ways using the align buttons in the **Position Size Align Vectors** area of the **Assistant's** Home page.

When you select the vector objects that you want to position relative to one another, it is important to remember that every vector object that you select will be aligned to the vector object selected last. This is referred to as the base vector object.

To align two or more vector objects:

1. Select two or more vector objects that you want to position relative to one another. For details, see "Selecting Vectors" on page 172. A bounding box surrounds all of the selected vector objects.
2. Click on the appropriate align button in the **Position Size Align Vectors** area of the **Assistant's** Home page to align all of the selected vector objects relative to the base vector object:

- Click on the **Align Left** button  to align the left edge of all other selected vector objects to the left edge of the base vector object.



---

**Note:** You can also align the left edge of all other selected vector objects to the left edge of the base vector object by pressing the **Ctrl + ←** keys on your keyboard.

---

- Click on the **Align Right** button  to align the right edge of all other selected vector objects to the right edge of the base vector object.



---

**Note:** You can also align the right edge of all other selected vector objects to the right edge of the base vector object by pressing the **Ctrl + →** keys on your keyboard.

---

- Click on the **Align Top** button  to align the top edge of all other selected vector objects to the top edge of the base vector object.



---

**Note:** You can also align the top edge of all other selected vector objects to the top edge of the base vector object by pressing the **Ctrl + ↑** keys on your keyboard.

---

- Click on the **Align Bottom** button  to align the bottom edge of all other selected vector objects to the bottom edge of the base vector object.



---

**Note:** You can also align the bottom edge of all other selected vector objects to the bottom edge of the base vector object by pressing the **Ctrl + ↓** keys on your keyboard.

---



---

**Note:** You can also align the selected vectors relative to the base vector object using the Main menu bar. Click on the **Vectors** menu, and then on the **Align Vectors** option followed by the alignment option you want to use: **Left**, **Right**, **Top** or **Bottom**.

---

## Centring Vectors



You can centre one or more vector objects inside of another in different ways using the centring buttons in the **Position Size Align Vectors** area of the **Assistant's** Home page.

When selecting the vector objects that you want to centre inside of another, it is important to remember that every vector object you select will be centred inside of the vector object selected last. This is referred to as the base vector object.

To centre one or more vector objects inside of another:

1. Select two or more vector objects that you want to position relative to one another. For details, see "Selecting Vectors" on page 172.

2. Click on any of the centring buttons in the **Position Size Align Vectors** area to centre all of the selected vector objects inside of the base vector object:

- Click on the **Centre Vertically** button  to align the centre of all other selected vector objects to the centre in the X-axis of the base vector object.
- Click on the **Centre Horizontally** button  to align the centre of all other selected vector objects to the centre in the Y-axis of the base vector object.
- Click on the **Centre Vector** button  to align the centre of all other selected vector objects to the centre of the base vector object.

There is one additional centring button in the **Position Size Align Vectors** area of the **Assistant's** Home page, although it does not, unlike the other centring buttons, affect one vector object relative to another:

- Click on the **Centre In Page** button  to align the centre of the selected vector objects to the centre of the model area (the white area).



---

**Note:** You can also centre all of the selected vector objects inside of the base vector object using the Main menu bar, by clicking on the **Vectors** menu, followed by the **Align Vectors** option and then on the alignment option that you want to use: **Horizontal Centre**, **Vertical Centre**, **Centre** or **Centre In Page**.

---



---

**Note:** You can also align the centre of the selected vector objects with the centre of the model area (the white area) by pressing the **F9** key on your keyboard.

---

## Merging Vectors

You can merge two or more shapes of vector objects in order to create a new shape of vector object using the merging buttons in the **Group Merge Join Trim Vectors** area of the **Assistant's** Home page. The newly merged vector object is drawn on the currently active layer.



---

**Warning:** You can only merge two or more vector objects if they are ungrouped and overlapping. For further information, see "Ungrouped Vectors" on page 274.

---

To merge two or more ungrouped vector objects:

1. Select the vector objects that you want to merge. For details, see "Selecting Vectors" on page 172.
2. Click on any of the merging buttons in the **Group Merge Join Trim Vectors** area to merge the selected vector objects:



---

**Note:** You can also merge the selected vectors using the Main menu bar. Click on the **Vectors** menu, and then on the **Merge Vectors** option followed by the merging option you want to use: **Weld**, **Intersect**, **Subtract** or **Trim**.

---

- Click on the **Weld Vectors** button  to take two or more vector objects and create a new vector object that is the outline of them when fused together:



---

**Warning:** The **Weld Vectors** button  is the only merging button in the **Group Merge Join Trim Vectors** area of the **Assistant's** Home page that you can use to merge more than two overlapping vector objects.

---

*Before...*

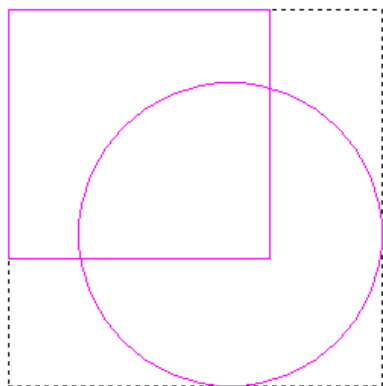

*After...*

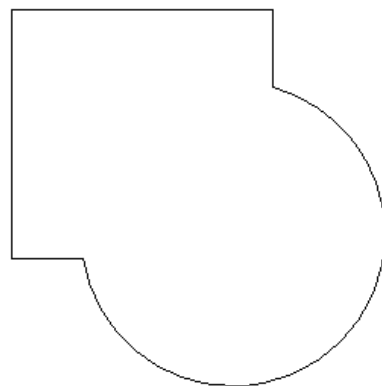

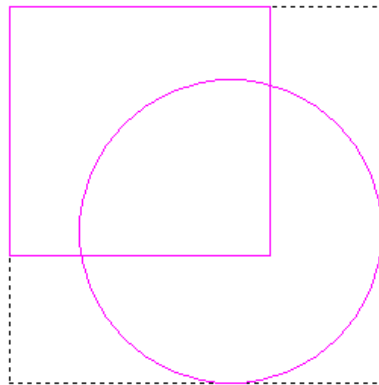

- Click on the **Intersect Vectors** button  to take two vector objects and create a new vector object that is the shape of the area where they overlap:

*Before...*

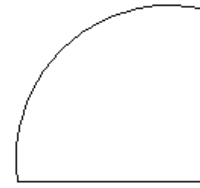

*After...*



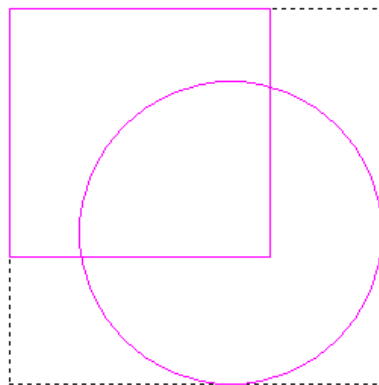

- Click on the **Subtract Vectors** button  to produce a vector object that is the shape of the area remaining when the vector object selected last is subtracted from that which was selected first:

*Before...*

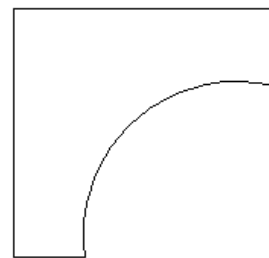

*After...*



- Click on the **Trim Vectors** button  to combine two selected vector objects in such a way that all that remains are the areas of the vector objects which are not overlapping:

*Before...*

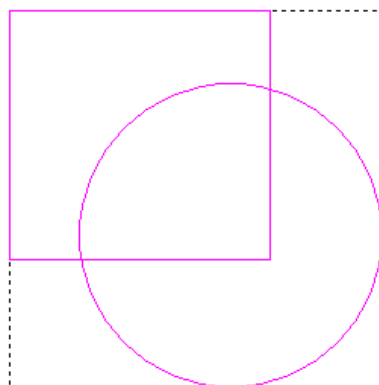

*After...*

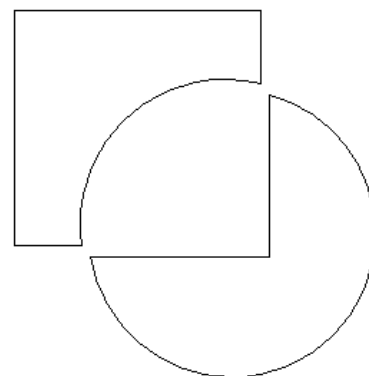

## Joining Vectors

You can join two or more vector objects to create one of four types of new shape using the joining buttons in the **Group Merge Join Trim Vectors** area of the **Assistant's** Home page. The newly joined vector object is drawn on the currently active layer.



---

**Note:** The vector objects must be open and ungrouped. For further information, see "Selecting Vectors" on page 172 and "Ungrouped Vectors" on page 274.

---

To join together open, ungrouped vector objects:

1. Hold the **Shift** key down on your keyboard, and then click to select the vector objects that you want to join together. For details, see "Selecting Vectors" on page 172.
2. Click on any of the joining buttons in the **Group Merge Join Trim Vectors** area of the **Assistant's** Home page to join the selected vector objects:



---

**Note:** You can also join the selected vectors using the Main menu bar. Click on the **Vectors** menu, and then on the **Join Vectors** option followed by the joining option you want to use: **with a smooth curve**, **with a line**, **move end points** or **with coincident points**.

---

- Click on the **Join Vectors With A Line** button



to link the nearest points in the two vector objects with a linear span:

*Before...*



*After...*

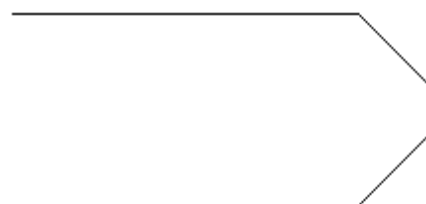

- Click on the **Join Vectors With A Curve** button



to link the nearest points in the two vector objects with a bezier curve span:



*Before...*



*After...*



- Click on the **Join Vectors By Moving Ends**

button  to link the nearest points in the two vector objects by moving each of their end points to a central position:

*Before...*



*After...*



- Click on the **Join Vectors With Coincident**

**Start or End Points** button  to display the **Join Multiple Vectors** page. For details, see "Joining Vectors with Coincident Points" on page 263.

## ***Joining Vectors with Coincident Points***

You can create freeform vector shapes by joining together open vector objects with concurrent start or end points (nodes).

For example overlapping circles exploded using the **Trim Tool** could have sections rejoined by selecting bezier spans with coincident start or end points to create an interesting vector object:

### *Joined Coincident Vectors...*

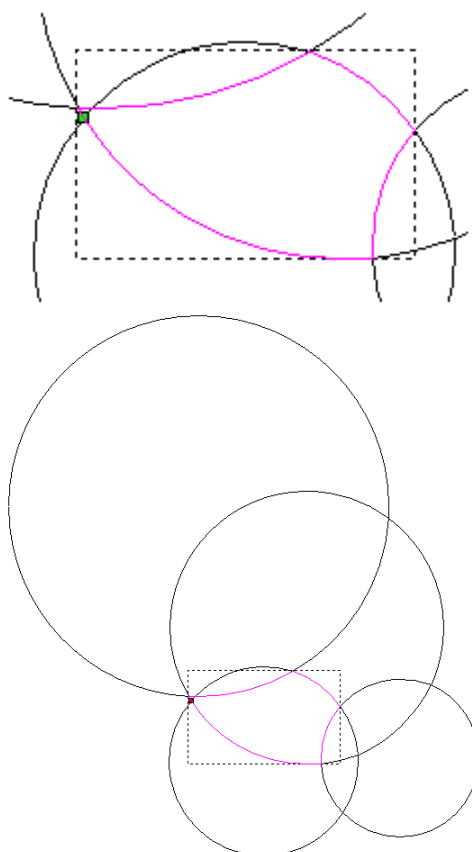

To join together vector objects with coincident start or end points:

1. Hold the **Shift** key down on your keyboard, and then click to select the vector objects that you want to join together. The vector objects turn magenta. For details, see "Selecting Vectors" on page 172.



---

**Note:** The selected vector objects must have coincident start or end points.

---

2. Click on the **Join Vectors with Coincident Start or End Points** button  in the **Group Merge Join Trim Vectors** area to display the **Join Multiple Vectors** page.
3. If you only want ArtCAM Pro to join coincident points in the selected vector objects within a specific distance of one another, define the distance in the **Tolerance** box.
4. To calculate the number of vector objects that will remain after joining the coincident points in the selected vector objects within tolerance, click on the **Calc Info** button.
5. Click on the **Join** button to join the coincident points in the selected vector objects within tolerance.



---

**Note:** You can also join the coincident points in the selected vector objects within tolerance by pressing the **J** key on your keyboard.

---

6. Click on the **Close** button to return to the **Assistant's** Home page.

## Closing Vectors

You can close an open vector object to create one of three types of closed vector object using the closing buttons in the **Group Merge Join Trim Vectors** area of the **Assistant's** Home page.



---

**Note:** The vector objects must be ungrouped. For further information, see "Selecting Vectors" on page 172 and "Ungrouped Vectors" on page 274.

---

To close an open vector object:

1. Select the vector object that you want to close. For details, see "Selecting Vectors" on page 172.. The selected vector object is magenta.
2. Click on any of the closing buttons in the **Group Merge Join Trim Vectors** area of the **Assistant's** Home page:



---

**Note:** You can also close the selected vectors using the Main menu bar. Click on the **Vectors** menu, and then on the **Close Vector** option followed by the closing option you want to use: **with a smooth curve**, **with a line**, or **move end point**.

---

- Click on the **Close Vector With A Line** button



to join the Start Point and end point with a linear span, as shown below:

*Before...*

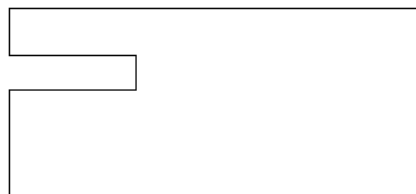

*After...*

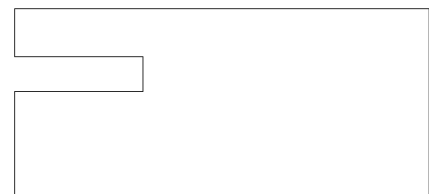

- Click on the **Close Vector With A Curve** button



to join the Start Point and end point with a bezier curve span, as shown below:

*Before...*

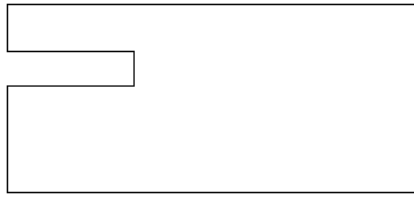

*After...*

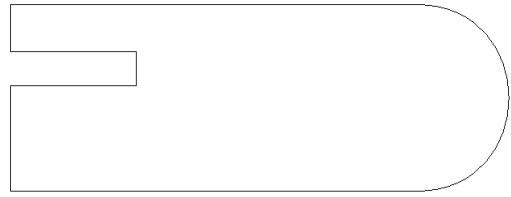

- Click on the **Close Vector – Move End Points**

button  to join the end point with the Start Point, as shown below:

*Before...*

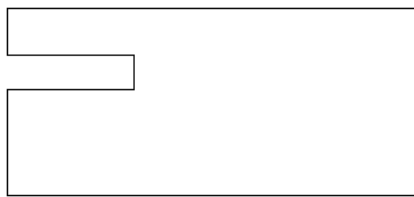

*After...*

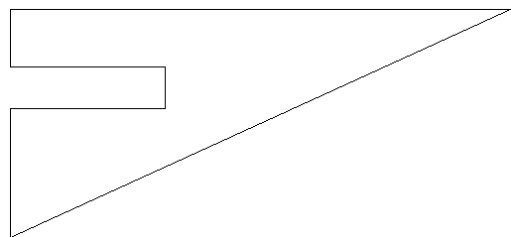

## Clipping Vectors

All vector objects in, around or intersecting a clipping region can be clipped in several ways. You can use either open or closed vector objects to define the clipping region.

To clip a selection of vector objects:

1. Select the vector object(s) that you want to use as the clipping region. For details, see "Selecting Vectors" on page 172.

If you want to use more than one vector object as the clipping region, you must group all of them first. For details, see "Grouping Vector Objects" on page 270.

2. Hold the **Shift** key down on your keyboard, and then click to select the vector objects that you want to clip. Some or all of these vector objects must be within or intersecting the clipping region.

In the following example, we will use a shoe sole shaped vector object as the clipping region and a pattern of circles as the vector objects that we want to clip:

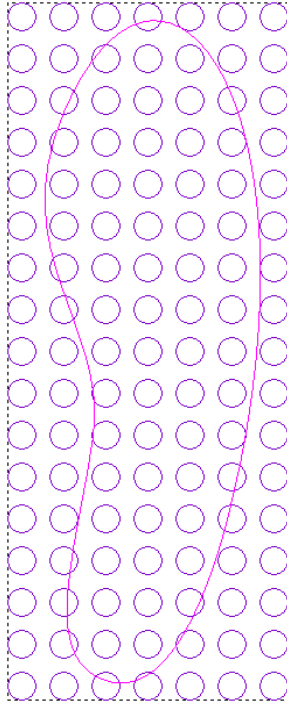



3. Click on the **Vector Clipping** button  in the **Group Merge Join Trim Vectors** area to display the **Vector Clipping** page.



---

**Note:** You can also display the **Vector Clipping** page from the Main menu bar by clicking on the **Vectors** menu followed by the **Clip vectors to boundaries** option.

---

4. In the **Clipping Direction** area, click to select the option for the direction in which you want to clip the selected vector objects:
  - If you want to keep the area of the vector objects within the clipping region, click to select the **Inside** radio button .
  - If you want to keep the area of the vector objects outside of the clipping region, click to select the **Outside** radio button .

In our example, we will keep the area of the circles within the clipping region.

5. In the **Overlapping Vectors** area, click to select the option for how you want ArtCAM Pro to edit vector objects which intersect the clipping boundary:

- If you want to trim all overlapping vector objects to the clipping boundary, click to select the **Trim** radio button . This option is selected by default.
- If you want to delete all vector objects intersecting the clipping boundary, click to select the **Delete** radio button .
- If you want to keep all vector objects intersecting the clipping boundary, click to select the **Keep** radio button .

6. Click on the **Clip Vectors** button.

In our example, you can see the results of each of the methods of clipping the circles overlapping the clipping region:

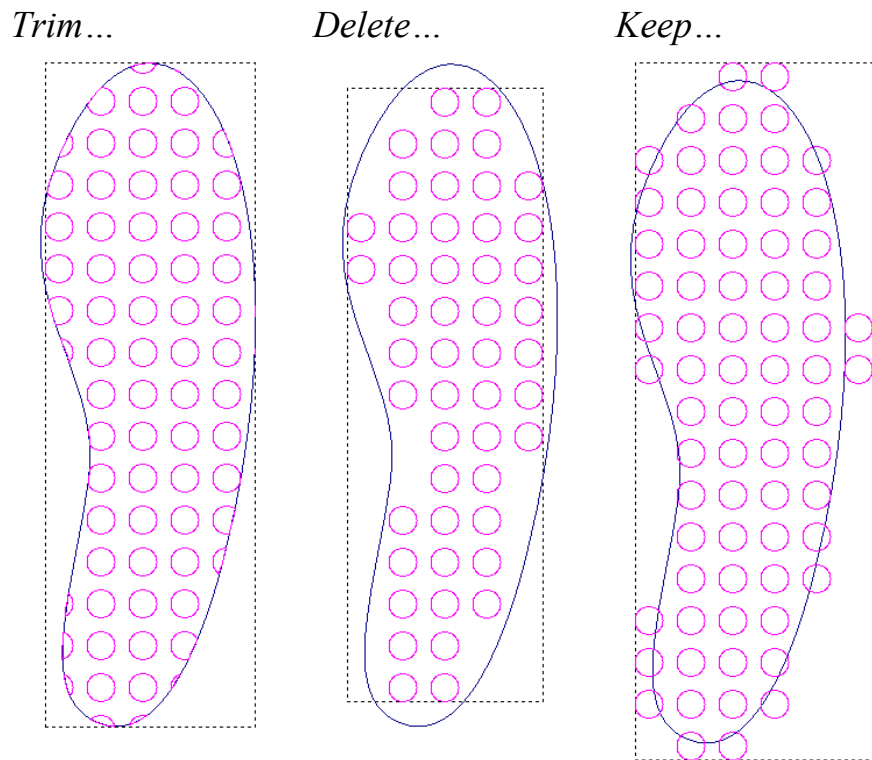

7. Click on the **Close** button to return to the **Assistant's** Home page.

## Slicing Vectors

You can divide a selection of vector objects using a vector object such as a polyline, an imaginary vertical line defined as a Y co-ordinate, an imaginary horizontal line defined as an X co-ordinate, a vertical guideline or a horizontal guideline.

For example, you can see how a vector artwork design can be sliced in two using only a polyline:

*Before...*

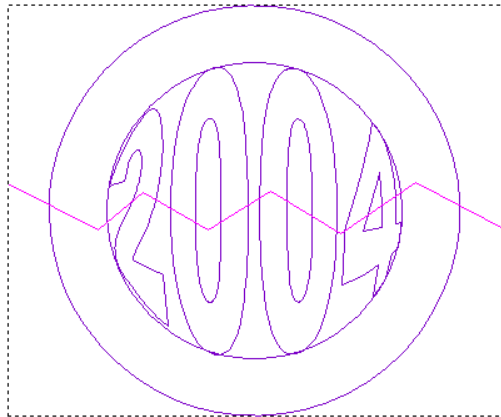

*After...*

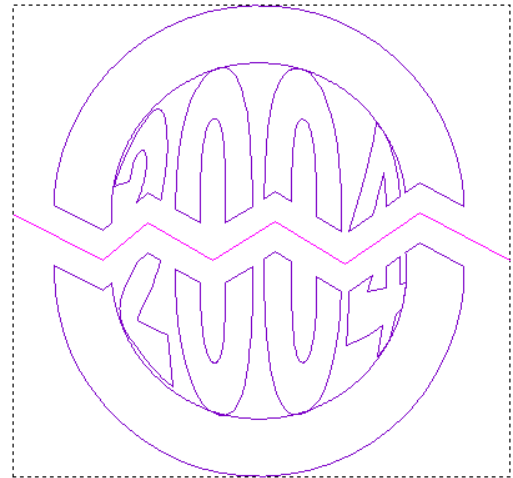

To slice a selection of vector objects:

1. Select the vector object(s) that you want to slice. For details, see "Selecting Vectors" on page 172.
2. Click on the **Slice Selected Vectors** button  in the **Group Merge Join Trim Vectors** area to display the **Vector Slice** page.
3. In the **Closing Method** area, select how you want to leave the selected vector objects after the slicing process:
  - If you want the selected vector objects to be closed after being sliced, click to select the **Close** radio button .
  - If you want the selected vector objects to be open after being sliced, click to select the **Leave Vectors Open** radio button .
4. In the **Slicing Method** area, select how you want to slice the selected vector objects:
  - If you want to use the last selected vector object to slice all previously selected vector objects, click to select the **Use last selected vector** radio button .



---

**Note:** You must have at least two vector objects selected prior to selecting the vector object that you want to use for slicing. For details, see "Selecting Vectors" on page 172.

---

- If you want to use a vertical line to slice the selected vector objects, click to select the **Use a vertical line** radio button , and then define the position on the Y-axis along which you want to slice in the **Line Coordinate** box.



---

**Note:** You can also use a vertical guideline to slice the vector objects. When using a guideline, its Y co-ordinate is displayed in the **Line Coordinate** box. For details, see "Using Guidelines" in the ArtCAM Pro Layout chapter.

---

- If you want to use a horizontal line to slice the selected vector objects, click to select the **Use a horizontal line** radio button , and then define the position on the X-axis along which you want to slice in the **Line Coordinate** box.



---

**Note:** You can also use a horizontal guideline to slice the vector objects. When using a guideline, its X co-ordinate is displayed in the **Line Coordinate** box. For details, see "Using Guidelines" in the ArtCAM Pro Layout chapter.

---

5. Click on the **Slice Vectors** button.
6. Click on the **Close** button to return to the **Assistant's** Home page.

---

## Grouping Vector Objects

Grouping combines all of the individual spans, points (nodes) and control points that make up a vector object as a single entity.

You can group an individual vector object or a selection of them. This process allows you to simultaneously machine or engrave each of the vector objects that you define as a group in the same way. For details, see "Selecting Vectors" on page 172.

Grouping allows you to machine or engrave an open vector object along with an individual or group of closed vector objects when using certain toolpaths. These toolpaths are **Engraving** and **Drilling**. For details, see "Using Toolpaths" in the Machining Models chapter.

To group an open vector object:



1. Select the vector object that you want to group. For details, see "Selecting Vectors" on page 172. The selected vector object is magenta.
2. Click on the **Group** button  in the **Group Merge Join Trim Vectors** area of the **Assistant's** Home page. The vector object turns purple. When deselected, the vector object is blue, regardless of the colour assigned to the layer on which it is drawn.





---

**Note:** You can also group the selected vector object(s) by pressing the **Ctrl + G** keys on your keyboard or by clicking on the **Vectors** menu in the Main menu bar, and then on the **Group Vector(s)** option.

---

To group a closed vector object:

1. Select the vector object that you want to group. For details, see "Selecting Vectors" on page 172.
2. Click on the **Group** button  in the **Group Merge Join Trim Vectors** area of the **Assistant's** Home page. The vector object turns purple.

If you group a closed vector object containing self-intersections, when deselected it turns red with the  icon marking the position of all intersections.

If you select a combination of open and closed vector objects with the intention of grouping them, all of them turn magenta. However, when they have been grouped and deselected, the closed vector objects appear in the colour assigned to the layer on which they are drawn, while the open vector objects appear in blue regardless of the colour assigned to the layer on which they are drawn.



---

**Note:** You can also right-click on the selected vector object to display the Vector Editing menu, and then click on the **Group Vector(s)** option.

---

You can also ungroup vector objects. To ungroup any vector object:

1. Select the vector object that you want to ungroup. For details, see "Selecting Vectors" on page 172.

2. Click on the **Ungroup** button  in the **Group Merge Join Trim Vectors** area of the **Assistant's** Home page. The vector object is deselected. If the selected vector object is open, the vector object turns blue, regardless of the colour assigned to the layer on which it is drawn. If the selected vector object is closed, it appears in the colour assigned to the layer on which it is drawn.



---

**Note:** You can also group the selected vector object(s) by pressing the **Ctrl + U** keys on your keyboard or by clicking on the **Vectors** menu in the Main menu bar, and then on the **Ungroup Vector(s)** option.

---



---

**Note:** You can also right-click on the selected vector object to display the Vector Editing menu, and then click on the **Ungroup Vector(s)** option.

---

---

## Viewing the Properties of a Vector Object

You can find out the number of points (nodes), linear, bezier curve or arc spans within any ungrouped vector object using the **Vector Properties** dialog box.

To view the properties of an ungrouped vector object:

1. Select an ungrouped vector object. For details, see "Selecting Vectors" on page 172.
2. Right-click to display the Vector Editing menu, then click on the **Properties...** option to display the **Vector Properties** dialog box.

The **General** page of the **Vector Properties** dialog box is displayed by default:

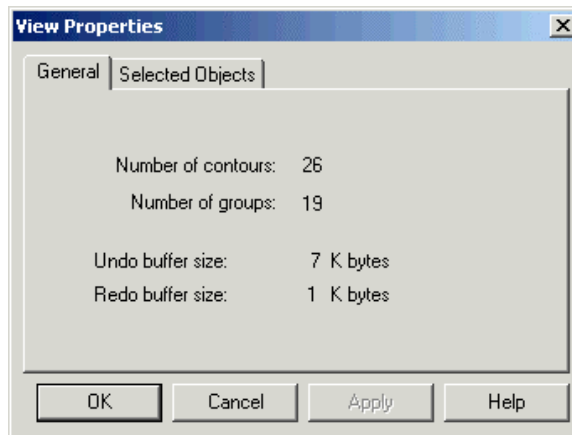

The **Number of contours** area shows the total number of ungrouped vector objects currently selected.

The **Number of groups** area shows the total number of grouped vector objects currently selected.

3. Click on the **Selected Objects** tab to display its page.

The **Number of selected vectors** area shows the total number of ungrouped vector objects currently selected.

The **Number of selected groups** area shows the total number of grouped vector objects currently selected.

The **Total number of points** area shows the number of points and control points in the selected vector object(s). The number of points and control points are not counted separately. For details, see "Editing Vector Nodes" on page 182.

The **Average number of points** area shows the total number of points divided by the total number of vector objects currently selected.

4. Click on the **OK** button to close the **Vector Properties** dialog box.

To view the properties of an ungrouped vector object:

1. Select an ungrouped vector object. For details, see "Selecting Vectors" on page 172.
2. Right click to display the Vector Editing menu, and then click on the **Properties** option to display the **Properties** dialog box:

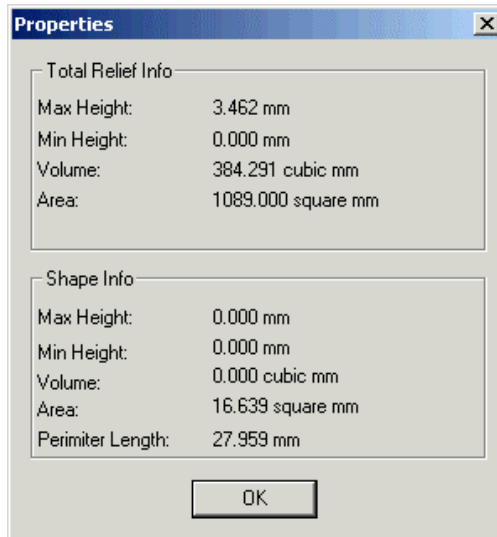

You can see the area and the perimeter length of the selected vector object in the **Shape Info** area. The perimeter length is equal to the total length of all spans within the selected vector object.

If a shape has been attributed to the selected vector object, you can also see its volume and its maximum and/or minimum height.

3. Click on the **OK** button to close the **Properties** dialog box.

---

## Reversing a Vector Object's Direction

You can reverse the current direction of any closed vector object. The direction of a vector object determines the cutting direction in the toolpath used during the machining process.

### Ungrouped Vectors

You can reverse the direction of an ungrouped, closed vector object that you have created.

To reverse the direction of an ungrouped, closed vector object:

1. Select an ungrouped, closed vector object. For details, see "Selecting Vectors" on page 172. The vector object is magenta.
2. Right-click to display the Vector Editing menu, and then click on whichever direction change option is available:
  - **Make Clockwise** – To set the vector object's direction as clockwise.

- **Make Anti-Clockwise** – To set the vector object's direction as anti-clockwise.

## Grouped Vectors

You can reverse the direction of a grouped, closed vector object that you have created.

To reverse the direction of a grouped, closed vector object:

1. Select a grouped, closed vector object. For details, see "Selecting Vectors" on page 172. The selected vector object is purple.
2. Right-click to display the Vector Editing menu, then click on the **Reverse Vector(s)** option.



You can confirm the direction of a grouped, closed vector object by ungrouping it after you click on the **Reverse Vector(s)** option, and then regrouping it again. For details, see "Grouping Vector Objects" on page 270.

---

## Creating Bitmaps from Vectors

You can create a bitmap image from any vector object. ArtCAM Pro creates bitmap images in the current Primary Colour around the outline of all selected vector objects. The new bitmap image is one pixel wide. For details, see "Selecting the Primary and Secondary Colours" in the Working with Bitmaps chapter.

To convert a vector object into a bitmap image:

1. Click on the colour in the Colour Palette that you want to select as the Primary Colour.
2. Select the vector objects that you want to create bitmap images from. For details, see "Selecting Vectors" on page 172.
3. Click on the **Vector to Bitmap** button  in the **Vector – Bitmap** area of the **Assistant's** Home page to create bitmap images from the selected vector objects.
4. Click on the **Vectors On/Off** button  in the **2D View** toolbar to hide the original vector objects, allowing you to see the new bitmap images clearly.



## Flood Filling Vector Objects



You can colour within the outline of any vector object in the current Primary Colour using the **Flood Fill Vectors** tool. For details, see "Selecting the Primary and Secondary Colours" in the Working with Bitmaps chapter.

To flood fill a vector object:

1. Click on the colour in the Colour Palette that you want to select as the Primary Colour.

If you want to select a colour from a bitmap image as the

Primary Colour, click on the **Pick Colour** button  in the **Bitmap** toolbar, then move the dropper  over the colour you want to use and click.

2. Select the vector object(s) that you want to flood fill. For details, see "Selecting Vectors" on page 172.
3. Click on the **Flood Fill Vectors** button  in the **Vector – Bitmap** area of the **Assistant's** Home page to colour within the outline of the selected vector objects.
4. Click on the **Vectors On/Off** button  in the **2D View** toolbar to hide the original vector objects, allowing you to see the new bitmap images clearly.

---

## Importing Vector Artwork

In ArtCAM Pro, you can import vector artwork saved as **\*.dxf**, **\*.eps**, **\*.dwg**, **\*.ai**, **\*.wmf** or **\*.pic** files into an open model. For more details, see "Importing Vector Artwork" in the Working with Models chapter.

---

## Exporting Vector Artwork

In ArtCAM Pro, you can export vector artwork as an **\*.eps**, **\*.dxf** or **\*.pic** file to be used in other packages. For details, see "Exporting Vector Artwork" in the Working with Models chapter.

---

## Creating a Shape from a Vector

You can generate three-dimensional shapes from vector objects using the **Shape Editor** tool. You can also create complex freeform three-dimensional shapes from vector objects. For more details, see "Creating a Shape from a Vector" and "Creating a Shape Using Vectors" in the Working with Reliefs chapter.

---

## Creating a Feature from a Vector

You can create three different types of features from a vector object:

A depth or height is attributed to the vector object from which the feature is created. The feature is either added to or subtracted from the surface of the existing relief in your model. The contour of the existing relief is preserved in the feature that is combined with it.

A feature is machined using a **Feature Machining** toolpath. For information on toolpaths, see "Overview" in the Machining Models chapter. For details on creating a **Feature Machining** toolpath, see "Feature Machining" in the Machining Models chapter.

### Creating a Raised Feature

You can create a raised (male) feature from a selected vector object, usually vector text, which you can then machine using the **Feature Machining** tool. For details, see "Feature Machining" in the Machining Models chapter.

Using the **Raised Feature** page, you can:

- Control whether any central cavity in the vector object is removed or not during the feature machining process.
- Control what edge of the vector object the tool meets when cutting it from the block of material.

To create a raised feature:

1. Select the vector object from which you want to create a raised feature. For details, see "Selecting Vectors" on page 172.
2. Click on the **Toolpaths** tab  to display the **Toolpaths** Home page.

3. Click on the **Raised Feature** button  in the **3D Toolpaths** area of the **Toolpaths** Home page to display the **Create Raised Feature** page.
4. Define the height of the raised feature you want to create in the **Feature Height** box.
5. If you want to add or remove extra material around the selected vector object, you can define the amount in the **Feature Allowance** box.

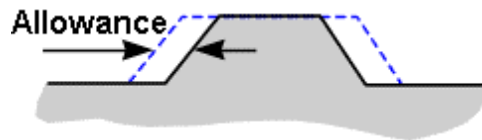

The value you define sets the distance between the boundary of the selected vector object and the **Feature Tool** that you select on the **Feature Machining** page. Type a positive value to add material or a negative value to remove it.

6. If the selected vector object contains a central cavity that you want to remove with the **Feature Tool** that you select on the **Feature Machining** page, click to select the **Clear Inner Islands** option .

If you do not select this option, the **Feature Tool** can only remove material inside of a central cavity as far as the **Feature Allowance** and/or **Overcut Distance** allow.

If you select this option, any **Feature Allowance** you have already defined and/or **Overcut Distance** that you define on the **Feature Machining** page is ignored by the **Feature Tool** you use to machine the raised feature.

In the following example, you can see that the **Feature Allowance** around the central cavity of the letter 'O' is ignored when the **Clear Inner Islands** option is selected .



*Clear Inner Islands Off...*

*Clear Inner Islands On...*

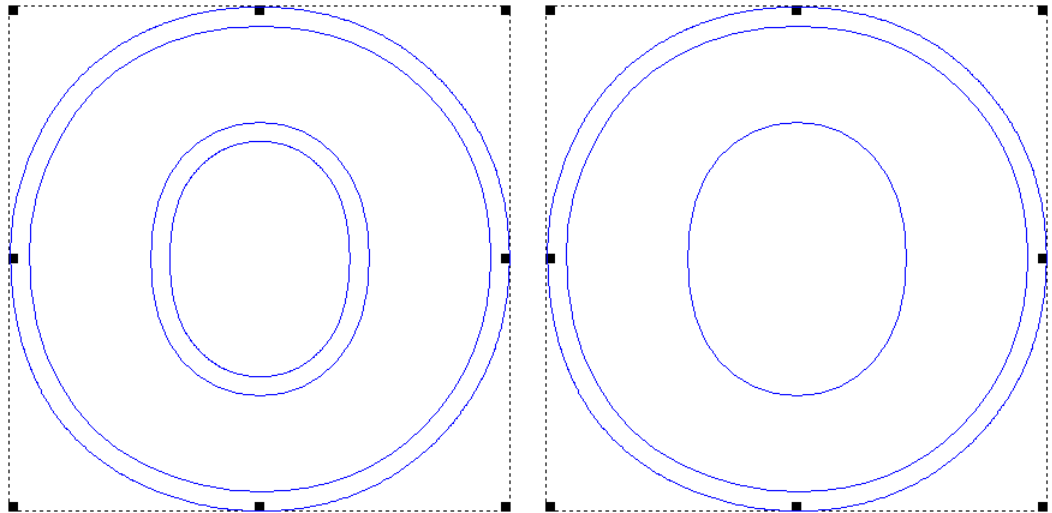

7. Click on either of the radio buttons  to set the limitations for machining the selected vector object:
  - If you want to leave an allowance around the boundary of the selected vector object, including any central cavity that it may contain, select the **Use constant allowance around vector** option .
  - If you want to machine around the boundary of the selected vector object, select the **Outer vector defines machining limit** option . If the selected vector object contains a central cavity, the cavity is not removed using this option. The **Feature Allowance** box is also greyed-out.
8. Click on either of the radio buttons  to select how the **Feature Tool** machines the selected vector object:
  - **Vector at Top Edge** – This option places the selected **Feature Tool** in contact with the top edge of the selected vector object during the machining process.

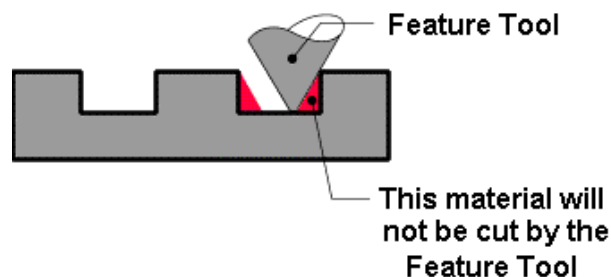

- **Vector at Bottom Edge** – This option places the selected **Feature Tool** in contact with the bottom

edge of the selected vector object during the machining process.

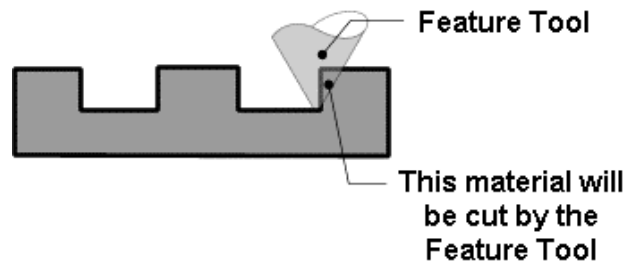

9. Type a name for the raised feature in the **Name** box.
10. Click on the **Create** button.
11. Click on the **Close** button to return to the **Toolpaths** Home page.

You are now ready to create the **Feature Machining** toolpath that is used to machine the raised feature you have created. For details, see "Feature Machining" in the Machining Models chapter.



## Creating a Recessed Feature

You can create a recessed (female) from a selected vector object, usually vector text, which you can then machine using the **Feature Machining** tool. For details, see "Feature Machining" in the Machining Models chapter.

Using the **Recessed Feature** page, you can:

- Control what edge of the vector object the tool meets when cutting it from the block of material.

To create a recessed feature:

1. Select the vector object from which you want to create a recessed feature. For details, see "Selecting Vectors" on page 172.
2. Click on the **Toolpaths** tab  to display the **Toolpaths** Home page.
3. Click on the **Recessed Feature** button  in the **3D Toolpaths** area to display the **Create Recessed Feature** page.
4. Define the depth of the recessed feature you want to create in the **Feature Depth** box.

5. Click on either of the radio buttons  to select how the **Feature Tool** you select on the **Feature Machining** page machines the selected vector object:

- **Vector at Top Edge** – This option places the selected **Feature Tool** in contact with the top edge of the selected vector object during the machining process.

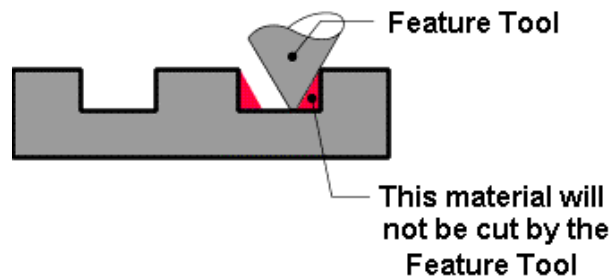

- **Vector at Bottom Edge** – This option places the selected **Feature Tool** in contact with the bottom edge of the selected vector object during the machining process.

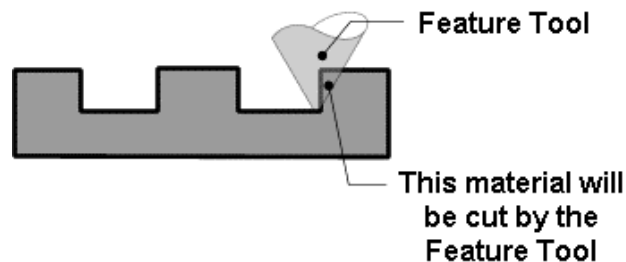

6. Type a name for the recessed feature in the **Name** box.
7. Click on the **Create** button.
8. Click on the **Close** button to return to the **Toolpaths** Home page.



You are now ready to create the **Feature Machining** toolpath that is used to machine the recessed feature you have created. For details, see "Feature Machining" in the Machining Models chapter.

## Creating a Centreline Engraved Feature

You can create a centreline engraved feature from a selected vector object, usually vector text, which you can then machine using the **Feature Machining** tool. For details, see "Feature Machining" in the Machining Models chapter.

The boundary of a selected vector object represents the centreline of the cutting tool. The engraved feature has no diameter other than that of the tip of the cutting tool.

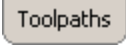
To create a centreline engraved feature:

1. Select the vector object from which you want to create a centreline engraved feature. For details, see "Selecting Vectors" on page 172.
2. Click on the **Toolpaths** tab  to display the **Toolpaths** Home page.
3. Click on the **Centreline Engraved Feature** button  in the **3D Toolpaths** area to display the **Create Centreline Feature** page.
4. Define the depth of the centreline engraved feature you want to create in the **Feature Depth** box.
5. Type a name for the centreline engraved feature in the **Name** box.
6. Click on the **Create** button.
7. You are now ready to create the **Feature Machining** toolpath that is used to machine the centreline engraved feature you have created. For details, see "Feature Machining" in the Machining Models chapter.

You are now ready to create the **Feature Machining** toolpath that is used to machine the centreline engraved feature you have created. For details, see "Feature Machining" in the Machining Models chapter.

## Returning a Feature to a Vector

You can return a raised, recessed or centreline engraved feature to the vector object from which it was created.

To return a raised, recessed or centreline engraved feature to its original vector object:

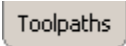
1. Click to select the feature in the **2D View** window that you want to return to a vector object. A bounding box surrounds it.
2. Click on the **Toolpaths** tab  to display the **Toolpaths** Home page.

3. Click on the **Return Feature To Normal Vectors** button  in the **3D Toolpaths** area.

In the following example, you can see a raised feature that has been returned to a vector object:

*Before...*

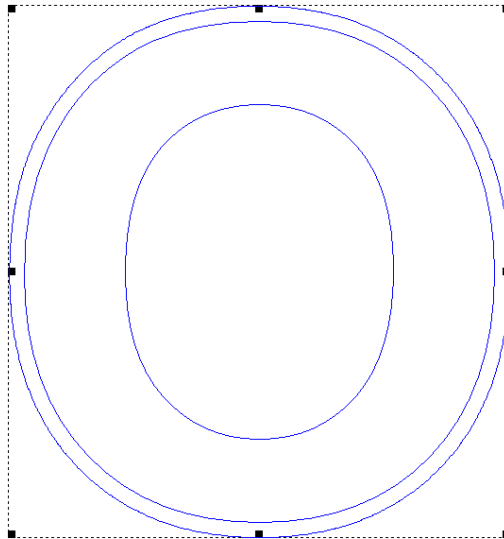

*After...*

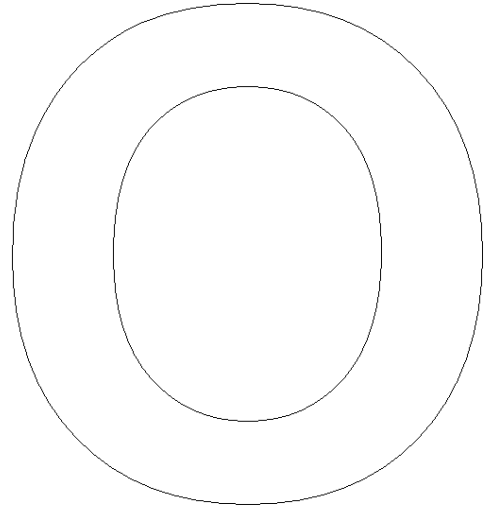

Notice that the pass around the boundary of the letter 'O' marking the **Feature Allowance** has also been removed.

The return to a vector object is noted by a change in colour. It is now shown in the colour assigned to the layer on which it is drawn.





You can also find tools in the **Relief Editing** area of the **Assistant's** Home page and on the **Relief Editing** toolbar that assist you in transforming, manipulating, managing and editing a relief:

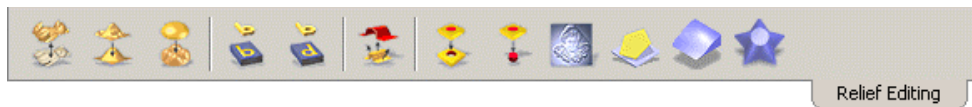

For details, see "Transforming and Manipulating Reliefs" on page 333 and "Managing and Editing Reliefs" on page 361.

---

## Using the Shape Editor

You can create simple shapes from either a colour in a bitmap image or a closed vector object using the **Shape Editor** tool and combine them with the existing relief. Using the **Shape Editor** tool, you can:



- Control the profile of the shape.
- Control the angle of the shape.
- Control the height of the shape.
- Control how the shape is combined with any existing relief.

### Creating a Shape from a Bitmap

You can create simple shapes from any colour in a bitmap image and combine the shape with the existing relief in your model using the **Shape Editor** tool.

To create a shape from a bitmap colour:

1. Double-click on the bitmap colour from which you want to create a shape to display the **Shape Editor** dialog box:
2. From the **Shape Editor** dialog box, select the profile of the shape that you want to create from the selected colour:

- Click on the **Round** button  to create a rounded shape from the selected colour.
- Click on the **Angular** button  to create an angled shape from the selected colour.
- Click on the **Plane** button  to create a flat shape from the selected colour.





---

**Note:** You can restore the default settings in the **Shape Editor** dialog box by clicking on the **Reset** button at any time.

---

3. If you want to create a rounded or an angled shape, you must define an angle using any of the following methods:
  - Type an angle in the **Angle** box. Type a positive value to produce a convex shape and a negative value to produce a concave shape. Type a value of 0 to produce a plane.
  - Click and drag on the slider to the left of the **Angle** box. Drag the slider upward to increase the angle of the shape. Drag the slider downward to decrease it. The angle appears in the **Angle** box.
  - Click on the up or down arrow on the right of the **Angle** box. The angle appears in the **Angle** box.

The default angle for a rounded or an angled shape is 45°.

4. Define the height at which the shape starts in the Z direction in the **Start Height** box. This creates a vertical side-wall beneath the shape. If you are creating a flat shape, this value controls the height of the plane.
5. Select the height option that you want to use:
  - To allow the shape to grow to the height that it would naturally reach, click on the **No Limit** radio button .

If you want to apply a scaling factor to the Z-axis of the shape, click to select the **Scale** option , and then define the scaling factor in the **Scale** box, or click and drag on the slider that is activated.

- To allow the shape to grow to a specific height and then plateau, click on the **Limit To Height** radio button , and then define the height in the **Height** box that is activated.

If the natural height of the shape exceeds that of the value you type in the **Height** box, a flat top appears on the shape.

If you want to apply a scaling factor to the shape in its Z-axis, click to select the **Scale** option , and

then define the scaling factor in the **Scale** box or click and drag on the slider that is activated.

- To allow the shape to grow to a specific height by applying a scaling factor in its Z-axis, click on the **Scale To Height** radio button , and then define the height in the **Height** box that is activated. This option does not produce a flat top on the shape.



---

**Note:** If you select the **Plane** option, all of the height options are greyed-out. If so, go straight to the next step.

---

6. Click on the **Apply** button to apply the settings you have made to the selected colour. The shape that you have chosen to create is shown in the selected colour within the Colour Palette beneath the **2D View** window:

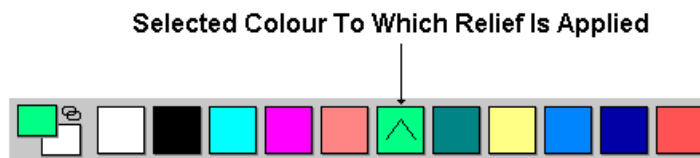

7. Select the relief combination method that you want to use:
  - Click on the **Add** button to add the points in the shape to the current relief. For more details, see "Adding to the Relief" on page 326.
  - Click on the **Subtract** button to subtract the points in the shape from the current relief. For more details, see "Subtracting from the Relief" on page 328.
  - Click on the **Zero** button to reset all areas of the current relief under the current Primary Colour to zero.
  - Click on the **Merge High** button to merge the shape with the current relief, so that only the highest points of the two show. For more details, see "Merging with the Relief" on page 330.
  - Click on the **Merge Low** button to merge the shape with the current relief, so that only the lowest points of the two show. For more details, see "Merging with the Relief" on page 330.

- Click on the **Zero Rest** button to reset all areas of the current relief other than those under the current Primary Colour to zero.

The **Calculating Relief** progress bar appears beneath the **2D View** window. You can stop the relief calculation process at any time by clicking on the  button.

8. Click on the **Close** button to close the **Shape Editor** dialog box.
9. Click on the **3D View** button  in the **2D View** toolbar to view the relief.

## ***Editing the Shape Attributes***

You can edit any of the shape attributes that you have applied to a colour in a bitmap image. Once you have adjusted the shape attributes you can then combine the new shape with the existing relief. It is important to remember that the new shape applied to the colour does not replace any part of the relief that was created from a shape previously applied to the same colour. The new shape can only be combined with the existing relief.

To edit the shape attributes:

1. Double-click on the colour in the Colour Palette for which you want to edit the shape attributes.

You can see the profile of the shape in the selected colour within the Colour Palette:

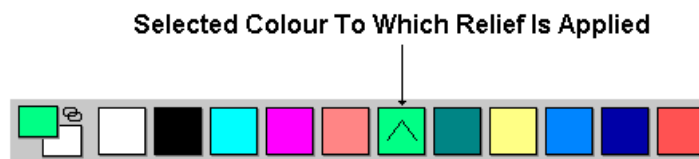

The **Shape Editor** dialog box appears showing the shape attributes currently applied to the selected colour:

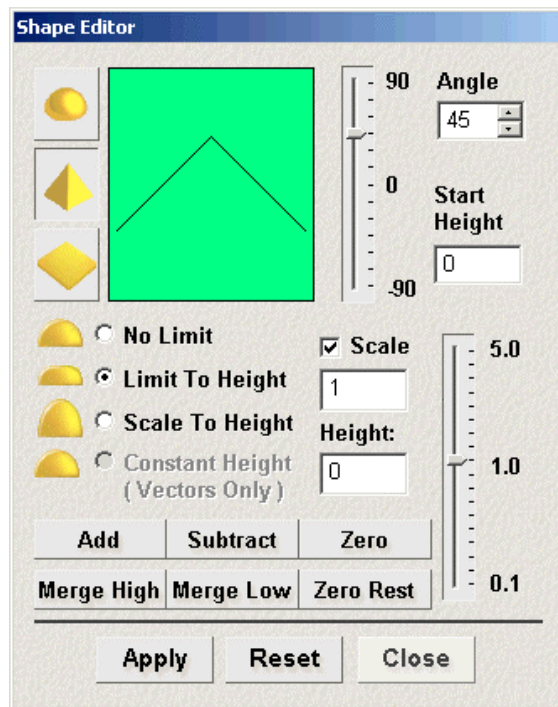

2. Follow the relevant steps in "Creating a Shape from a Bitmap" on page 286. By adjusting the current settings in the **Shape Editor** dialog box, you can change:
  - The profile of the shape.
  - The height of the shape.
  - The angle of the shape.
  - The start height of the shape.
  - The scale of the shape.
  - How the shape is combined with any existing relief.

## Creating a Shape from a Closed Vector

You can create simple shapes from any closed vector object and combine them with the existing relief using the **Shape Editor** tool.

To create a shape from a closed vector object:

1. Select the vector object from which you want to create a shape. For details, see "Selecting Vectors" in the Working with Vectors chapter.
2. Right-click on the selected vector object to display the Vector Editing menu, and then click on the **Shape Editor...** option to display the **Shape Editor** dialog box:

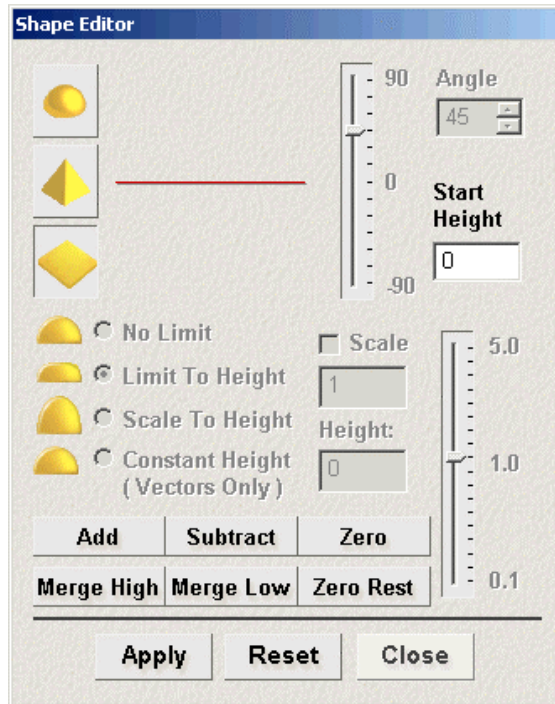





---

**Note:** You can also display the **Shape Editor** dialog box by double-click on the vector object from which you want to create a shape. If you use this method, be careful not to move the vector object.

---

3. From the **Shape Editor** dialog box, select the profile of shape that you want to create from the selected vector object:

- Click on the **Round** button  to create a rounded shape from the selected vector object.
- Click on the **Angular** button  to create an angled shape from the selected vector object.
- Click on the **Plane** button  to create a flat shape from the selected vector object.



---

**Note:** You can restore the default settings in the **Shape Editor** dialog box by clicking on the **Reset** button at any time.

---

4. If you want to create a rounded or an angled shape, you must define an angle for it using any of the following methods:

- Type an angle in the **Angle** box. Type a positive value to produce a convex shape and a negative value to produce a concave shape. Type a value of 0 to produce a plane.
- Click and drag on the slider to the left of the **Angle** box. Drag the slider upward to increase the angle of the shape. Drag the slider downward to decrease it. The angle appears in the **Angle** box.
- Click on the up or down arrow on the right of the **Angle** box. The angle appears in the **Angle** box.

The default angle for a rounded or an angled shape is 45°.

5. Define the height at which the shape starts in the Z direction in the **Start Height** box. This creates a vertical side-wall beneath the shape. If you are creating a flat shape, this value controls the height of the plane.
6. Select the height option that you want to use:
  - To allow the shape to grow to the height that it would naturally reach, click on the **No Limit** radio button .
  - To allow the shape to grow to a specific height and then plateau, click on the **Limit To Height** radio button , and then define the height in the **Height** box that is activated.
  - To allow the shape to grow to a specific height by applying a scaling factor in its Z-axis, click on the **Scale To Height** radio button , and then define the height in the **Height** box that is activated. This option does not produce a flat top on the shape.
  - To allow the shape to grow to a defined height, click on the **Constant Height (Vectors Only)** radio button , and then define the height in the **Height** box that is activated. This creates a shape where the angle or curvature changes to maintain a constant height, even where its width changes.





---

**Note:** If you have selected the **Plane** option, all of the height options are greyed-out. If so, go straight to the next step.

---

7. Click on the **Apply** button to apply the settings you have made to the selected vector object.
8. Select the relief combination method that you want to use:
  - Click on the **Add** button to add the points in the shape to the current relief. For more details, see "Adding to the Relief" on page 326.
  - Click on the **Subtract** button to subtract the points in the shape from the current relief. For more details, see "Subtracting from the Relief" on page 328.
  - Click on the **Zero** button to reset the relief within the area defined by the selected vector object to zero.
  - Click on the **Merge High** button to merge the shape with the current relief, so that only the highest points of the two show. For more details, see "Merging with the Relief" on page 330.
  - Click on the **Merge Low** button to merge the shape with the current relief, so that only the lowest points of the two show. For more details, see "Merging with the Relief" on page 330.
  - Click on the **Zero Rest** button to reset the current relief outside of the area defined by the selected vector object to zero.

The **Calculating Relief** progress bar appears beneath the **2D View** window. You can stop the relief calculation process at any time by clicking on the  button.

9. Click on the **Close** button to close the **Shape Editor** dialog box.
10. Click on the **3D View** button  in the **2D View** toolbar to view the relief.

## ***Editing the Shape Attributes***

You can edit any of the shape attributes that you have applied to a vector object. Once you have adjusted the shape attributes you can then combine the new shape with the existing relief. It is important to remember that the new shape applied to the vector object does not replace any part of the relief that was created from a shape previously applied to the same vector object. The new shape can only be combined with the existing relief.

To edit the shape attributes:

1. Select the vector object for which you want to edit its shape attributes. For details, see "Selecting Vectors" in the Working with Vectors chapter.
2. Right-click on the selected vector object to display the Vector Editing menu, and then click on the **Shape Editor** option to display the **Shape Editor** dialog box:

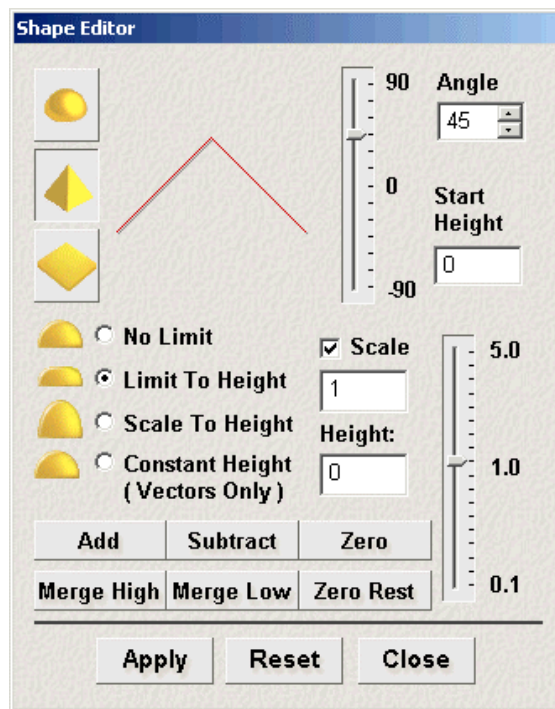

3. Follow the relevant steps in "Creating a Shape from a Closed Vector" on page 290. By adjusting the current settings in the **Shape Editor** dialog box, you can change:
  - The profile of the shape.
  - The height of the shape.
  - The angle of the shape.
  - The start height of the shape.
  - The scale of the shape.
  - How the shape is combined with any existing relief.

---

## Creating a Shape Using Vectors

You can create freeform shapes using vector objects and combine them with any existing relief in your model.



The freeform shapes that you can create using vector objects are as follows:

- **Swept Profile.** You can create three different types of swept profile shape using the **Swept Profiles Wizard** or any one of the three buttons in the **Vector Based Relief Creation** area of the **Assistant's** Home page. You can **Extrude**, **Spin** or **Turn** a swept profile. For details, see "Creating a Swept Profile Shape" on page 295.
- **Two-Rail Sweep.** You can create a two-rail swept shape using the **Two Rail Sweep** button in the **Vector Based Relief Creation** area of the **Assistant's** Home page and at least three vector objects. For details, see "Creating a Two Rail Sweep" on page 310.
- **Weave.** You can create a weave shape using the **Weave Wizard** button in the **Vector Based Relief Creation** area of the **Assistant's** Home page and two or more vector objects. For details, see "Creating a Weave Shape" on page 316.
- **ISO-Form Letters.** You can create ISO-Form letters using the **ISO-Form Letter** button in the **Vector Based Relief Creation** area of the **Assistant's** Home page and at least one vector object. For details, see "Creating ISO-FORM Letters" on page 320.

## Creating a Swept Profile Shape

A swept profile shape can be created using vector objects. You can create a swept profile shape in three different ways:

- **Extrude.** For details, see "Extruding a Shape" on page 295.
- **Spin.** For details, see "Spinning a Shape" on page 301.
- **Turn.** For details, see "Turning a Shape" on page 307.

### *Extruding a Shape*

You can extrude a shape using up to four vector objects. The first vector object defines the line along which the shape is extruded. This is referred to as the drive curve. The second defines the start cross-section of the shape, while the third defines the end cross-section. The vector object used to define the end cross-section can be the same as that used to define the start cross-section. The optional fourth vector object determines the height of the shape in the Z direction.

In the following example, you can see how shapes can be extruded from vector objects to form a harp:

*Before...*

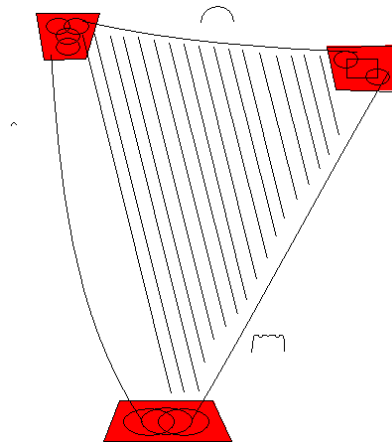

*After...*

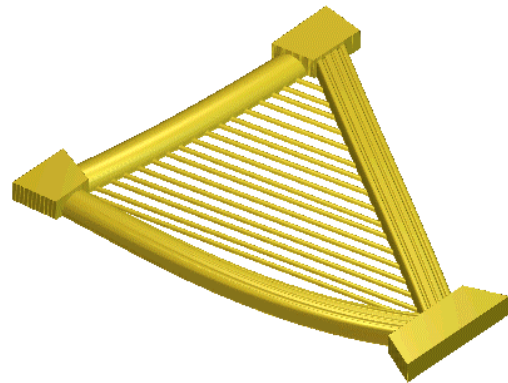

To extrude a shape:

1. Click on the **Extrude** button  in the **Vector Based Relief Creation** area of the **Assistant's Home** page to display the **Extrude Wizard**:

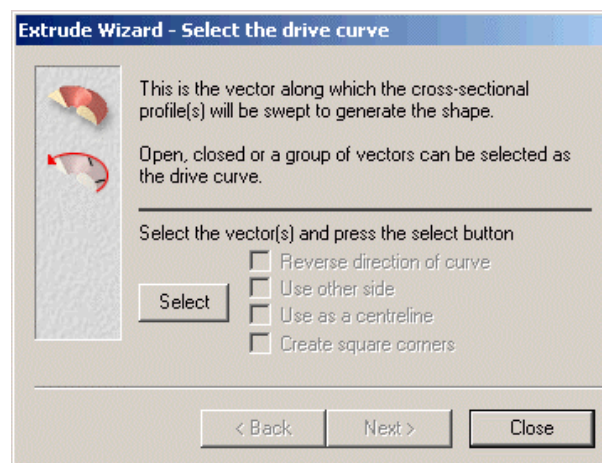

---

**Note:** You can also display the **Extrude Wizard** from the Main menu bar. Click on the **Relief** menu, and then on the **Swept Profiles Wizard...** option to display the **Swept Profiles Wizard**. Click on the **Extrude** radio button , and then on the **Next** button to display the **Extrude Wizard**.

---

2. Click to select the vector object in the **2D View** window along which you want the cross-section to be swept. This is referred to as the drive curve. For details, see "Selecting Vectors" in the Working with Vectors chapter.

- Click on the **Select** button. Arrows are displayed along the selected vector object to show the direction of the drive curve and on which side the cross-sections are to be attached.

In order to begin creating the frame of the harp in our example, the following polyline is selected as the drive curve:

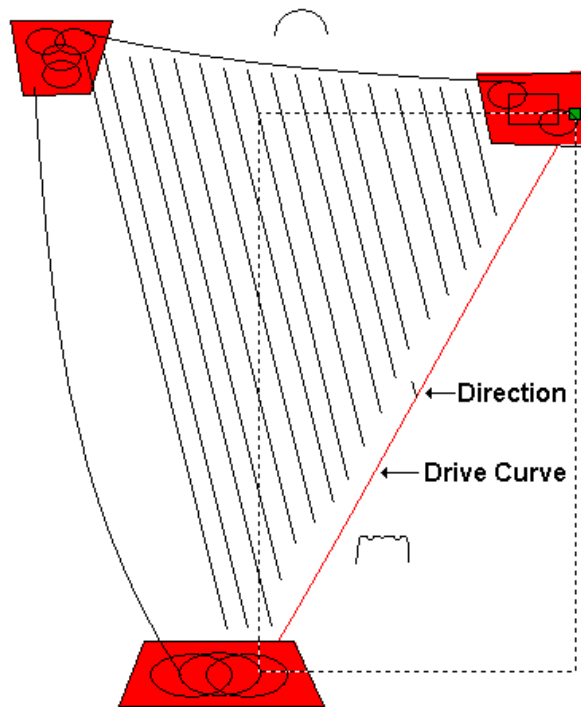

- If you want to change the properties of the drive curve, click on the options that you want to use:
  - To reverse the direction of the drive curve, click to select the **Reverse direction of curve** option . The arrows along the selected vector object change direction.
  - To change the side of the drive curve along which the cross-section is extruded, click to select the **Use other side** option . The arrows along the selected vector object change side.



---

**Note:** The **Use other side** option is greyed-out if you have the **Use as a centreline** option selected .

---

- If you want to use the drive curve as the centreline for the extrusion, click to select the **Use as a**

**centreline** option . Arrows are drawn along the centreline of the selected vector object.

- If you want to produce a drive curve with sharp-edged corners, click to select the **Create square corners** option .

5. Click on the **Next** button. The drive curve turns red.



---

**Tip:** If you want to change any of the settings after you have clicked on the **Next** button, click on the **Back** button to return to the previous page in the **Extrude Wizard**.

---

6. Click to select the open, ungrouped vector object in the **2D View** window that you want to use as the cross-section at the start of the extruded shape. This is referred to as the start profile.
7. Click on the **Select** button. The arrows on the start profile show the current Z-axis direction. The side of the start profile on which the arrows are positioned determine the side on which the shape is extruded.

In our example, the following vector object is selected as the start profile:

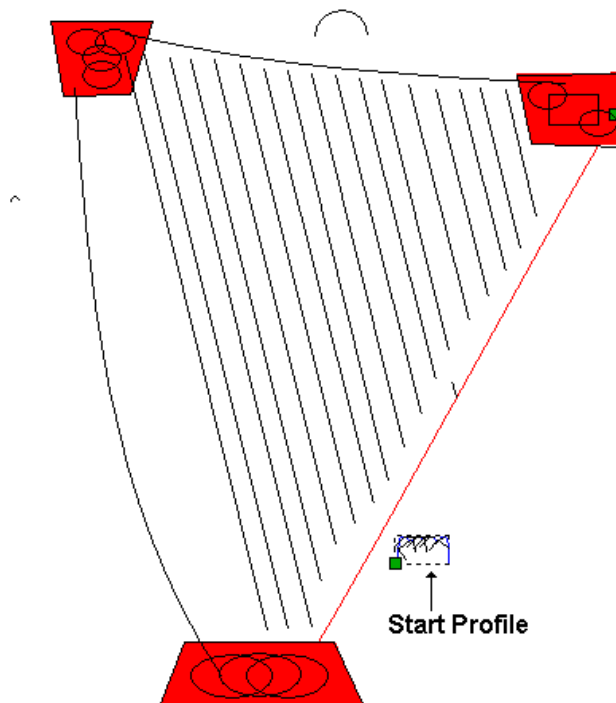

8. If you want to change the properties of the start profile, click on the options that you want to use:

- To change the position of the start point (node) in the selected vector object, click to select the **Move anchor point to other end** option . The start point (node) is green and determines which end of the start profile is attached to the drive curve.
- To invert the selected vector object in the Z-axis direction, click to select the **Invert curve in Z** option .

9. Click on the **Next** button. The start profile turns blue.

10. Click to select the open, ungrouped vector object in the **2D View** window that you want to use as the profile at the end of the extruded shape:

- If you want to use the same vector object that you had selected as the profile at the start of the extruded shape, make sure that the **End profile is the same as the start profile** option is selected , and then go straight to the next step.

In our example, the vector object used for the end profile is the same as that which was selected as the start profile.



---

**Note:** The **Select** button and the end profile options are greyed-out if the **End profile is the same as the start profile** option is selected .

---

- If you want to use another vector object in the model, make sure that the **End profile is the same as the start profile** option is deselected , click on the vector object that you want to use, and then click on the **Select** button.

If you want to change the properties of the end profile, select the options that you want to use:

- To change the position of the start point (node) in the selected vector object, click to select the **Move anchor point to other end** option . The start point (node) is green and determines which end of the end profile is attached to the drive curve.
- To invert the selected vector object in the Z-axis direction, click to select the **Invert curve in Z** option .

11. Click on the **Next** button. The end profile turns blue.
12. To add a contour and scale the swept profile in the Z-axis along its length:
  - First, click to select the **Use a z modulation vector** option .
  - Next, click to select the vector object that you want to use as the z modulation vector.
  - Now, click on the **Select** button.
  - To change the position of the start point (node) in the selected vector object, click to select the **Move anchor point to other end** option . The start point (node) is green and determines which end of the swept profile is attached to the drive curve.
  - To invert the selected vector object in the Z-axis direction, click to select the **Invert curve in Z** option .

If you do not want to scale the swept profile in the Z-axis along its length, go straight to the next step.

13. Click on the **Next** button. The z modulation vector turns green.
14. Select the relief combination method that you want to use:
  - Click on the **Add** radio button  to add the extruded shape to the current relief. For more details, see "Adding to the Relief" on page 326.
  - Click on the **Subtract** radio button  to subtract the extruded shape from the current relief. For more details, see "Subtracting from the Relief" on page 328.
  - Click on the **Merge Highest** radio button  to merge the extruded shape with the current relief, so that only the highest points of the two show. For details, see "Merging with the Relief" on page 330.
  - Click on the **Merge Lowest** radio button  to merge the extruded shape with the current relief, so that only the lowest points of the two show. For details, see "Merging with the Relief" on page 330.

15. Click on the **Extrude** button to combine the extruded shape with any existing relief in your model.
16. Click on the **3D View** button  in the **2D View** toolbar to display the **3D View** window. You can now see the relief.

In our example, the relief appears in the **3D View** window as follows:

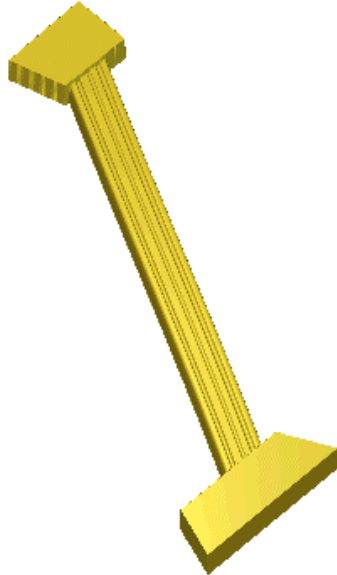

The blocks at the top and bottom of the harp frame in our example are created by applying a flat shape with a start height of 3.5 mm (0.14") to a bitmap colour marking the shape of the blocks, and then using the **Replace Relief**

button  to add the shapes to the relief. For more information, see "Creating a Shape from a Bitmap" on page 286 and "Replacing the Relief" on page 326.

17. Click on the **2D View** button  in the **3D View** toolbar to return to the **2D View** window.
18. Click on the **Close** button to close the **Extrude Wizard**.

## ***Spinning a Shape***

You can spin a shape using up to three vector objects. The first of these defines the start cross-section and the second defines the end cross-section of the shape. The vector object used to define the end cross-section can be the same as that used to define the start cross-section. The optional third vector object determines the height of the shape in the Z direction.

In the following example, you can see how a shape can be spun from vector objects, along with other relief editing techniques, to form a group of leaves:

*Before...*

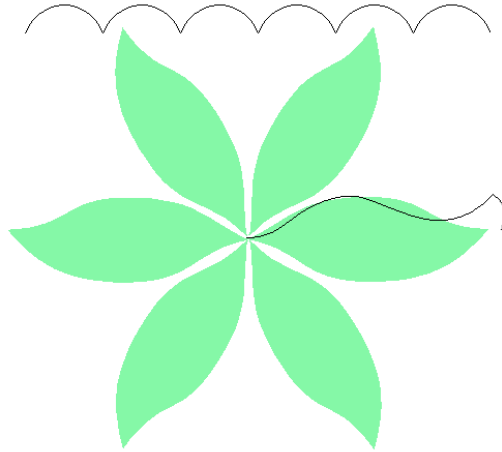

*After...*



To create a spun shape:

1. Click on the **Spin** button  in the **Vector Based Relief Creation** area of the **Assistant's Home** page to display the **Spin Wizard**:

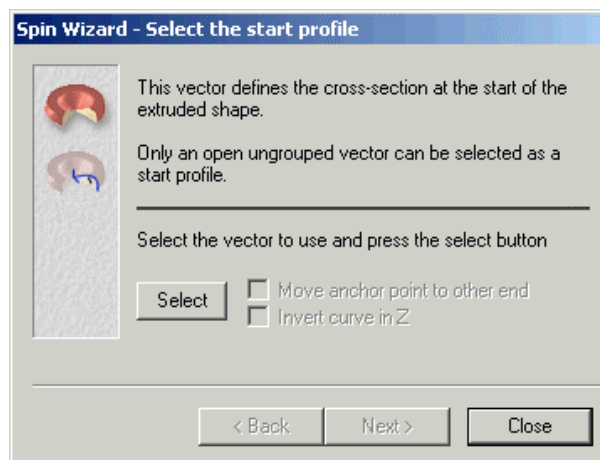

---

**Note:** You can also display the **Spin Wizard** from the Main menu bar. Click on the **Relief** menu, and then on the **Swept Profiles Wizard...** option to display the **Swept Profiles Wizard**. Click on the **Spin** radio button , and then on the **Next** button to display the **Spin Wizard**.

---

2. Click to select the open, ungrouped vector object in the **2D View** window that you want to use as the cross-section at the start of the spun shape. This is referred to as the start



profile. For details, see "Selecting Vectors" in the Working with Vectors chapter.

3. Click on the **Select** button. Arrows are displayed about the selected vector object to show the side on which the cross-sections are to be attached.
4. If you want to change the properties of the start profile, select the options that you want to use:
  - To change the position of the start point (node) in the selected vector object, click to select the **Move anchor point to other end** option . The start point (node) is green and determines the point around which the start profile is spun.
  - To invert the selected vector object in the Z-axis direction, click to select the **Invert curve in Z** option .
5. Click on the **Next** button. The start profile turns blue.

In order to begin creating the leaf design in our example, the following polyline is selected as the start profile:

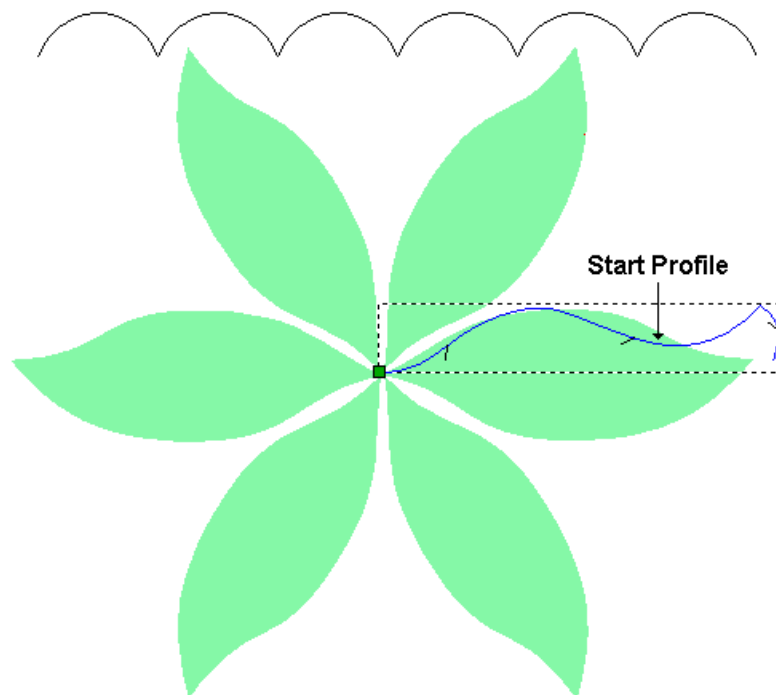

---

**Tip:** If you want to change any of the settings after you have clicked on the **Next** button, click on the **Back** button to return to the previous page in the **Spin Wizard**.

---

6. Click to select the open vector object that you want to use as the cross-section at the end of the spun shape. This is referred to as the end profile.
  - To use the same vector object that you have already used, make sure that the **End profile is the same as the start profile** option is selected , and then go straight to the next step.

In our example, the vector object used for the end profile is the same as that which was selected as the start profile.



---

**Note:** The **Select** button and the end profile options are greyed-out if the **End profile is the same as the start profile** option is selected .

---

- To use another vector object, make sure that the **End profile is the same as the start profile** option is deselected , click to select the vector object that you want to use, and then click on the **Select** button.

If you want to change the properties of the end profile, select the options that you want to use:

- To change the position of the start point (node) in the selected vector object, click to select the **Move anchor point to other end** option . The start point (node) is green and determines the point around which the end profile is spun.
  - To invert the selected vector object in the Z-axis direction, click to select the **Invert curve in Z** option .
7. Click on the **Next** button. The end profile turns blue.
  8. You are now ready to define how the profile is swept. If you want to sweep the profile through 360°, starting at 0°, click on the **Next** button. If you want to sweep the profile through a specific angle:
    - First, click to deselect the **Sweep through 360 degrees** option .
    - Next, define the start angle in the **Start Angle** box.
    - Now, click on the spin direction radio button  that you want to use. Click to select **Clockwise** if you want to sweep the profile in a clockwise direction

about the start point (node). Click to select **Anti-Clockwise** if you want to sweep the profile in an anti-clockwise direction about the start point (node).

- Next, define the finish angle in the **Finish Angle** box.
- Finally, click on the **Next** button.

In our example, the profile is swept through 360°.

9. If you want to scale the spun profile in the Z-axis along its length:

- First, click to select the **Use a z modulation vector** option .
- Next, click to select the vector object that you want to use as the z modulation vector.
- Next, click on the **Select** button.
- To change the position of the start point (node) in the selected vector object, click to select the **Move anchor point to other end** option . The start point (node) is green and determines the point around which the end profile is spun.
- To invert the selected vector object in the Z-axis direction, click to select the **Invert curve in Z** option .

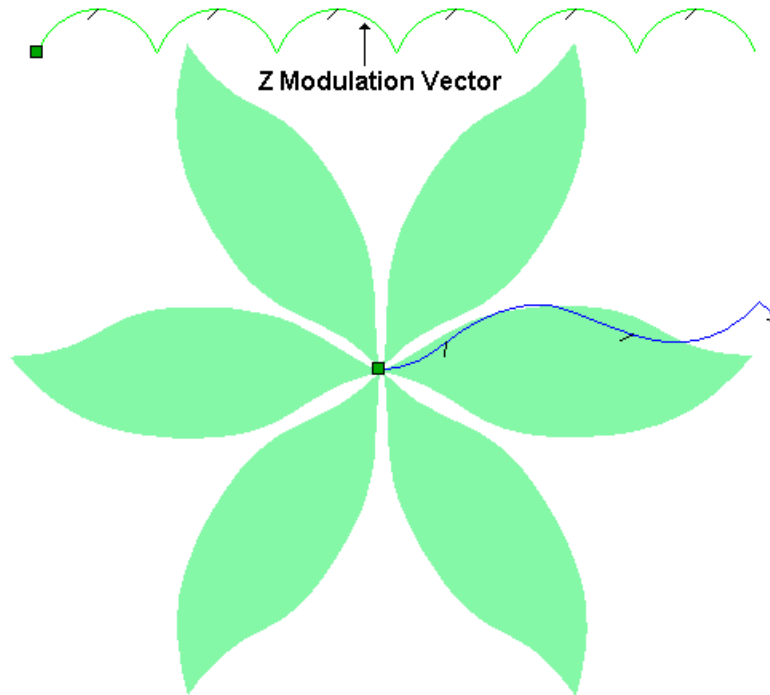

If you do not want to scale the spun profile in the Z-axis along its length, go straight to the next step.

In our example, the following polyline is selected as the z modulation vector:



10. Click on the **Next** button. The z modulation vector turns green.
11. Select the relief combination method that you want to use:
  - Click on the **Add** radio button  to add the spun shape to the current relief. For more details, see "Adding to the Relief" on page 326.
  - Click on the **Subtract** radio button  to subtract the spun shape from the current relief. For more details, see "Subtracting from the Relief" on page 328.
  - Click on the **Merge Highest** radio button  to merge the spun shape with the current relief, so that only the highest points of the two show. For details, see "Merging with the Relief" on page 330.
  - Click on the **Merge Lowest** radio button  to merge the spun shape with the current relief, so that only the lowest points of the two show. For details, see "Merging with the Relief" on page 330.

In our example, the **Add** option is used.

12. Click on the **Spin** button  to combine the spun shape with any existing relief in your model.
13. Click on the **3D View** button  in the **2D View** toolbar to display the **3D View** window. You can now see the relief.

In our example, the relief appears in the **3D View** window as follows:



The wave in the spun relief is achieved by using the z modulation vector.

The shape of the leaves in the relief is created by selecting green as the Primary Colour from the **2D View** window and then using the **Keep Under Colour** option from the **Relief** menu. For details, see "Selecting the Primary and Secondary Colours" in the Working with Bitmaps chapter and "Resetting the Relief Height" on page 360.

14. Click on the **2D View** button  in the **3D View** toolbar to return to the **2D View** window.
15. Click on the **Close** button to close the **Spin Wizard**.

## ***Turning a Shape***

You can turn a shape using a vector object. An imaginary line between the start point (node) and end point (node) in the selected vector object acts as an axis about which it is turned to create the cross-section of the shape.

In the following example, you can see how a shape can be turned using vector objects to form castle turrets:

*Before...*

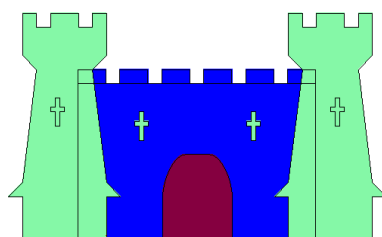

*After...*

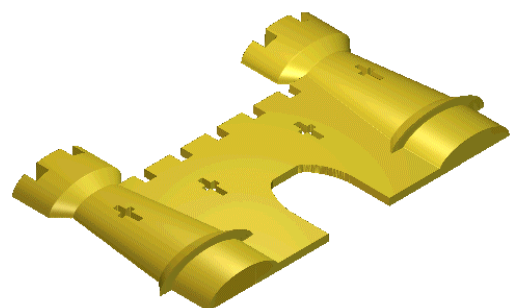

To create a turned shape:

1. Click on the **Turn** button  in the **Vector Based Relief Creation** area of the **Assistant's** Home page to display the **Turn Wizard**:

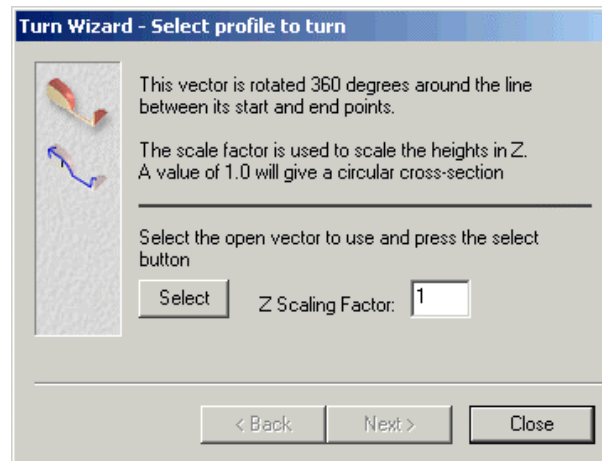

---

**Note:** You can also display the **Turn Wizard** from the Main menu bar. Click on the **Relief** menu, and then on the **Swept Profiles Wizard...** option to display the **Swept Profiles Wizard**. Click on the **Turn** radio button , and then on the **Next** button to display the **Turn Wizard**.

---

2. Click to select the open vector object that you want to use to create the cross-section of the shape. This is referred to as the profile. For details, see "Selecting Vectors" in the Working with Vectors chapter.
3. Click on the **Select** button. Arrows are displayed about the selected vector object to show the side on which the cross-section is to be attached.

In order to begin creating castle turrets in our example, the following polyline is selected as the start profile:

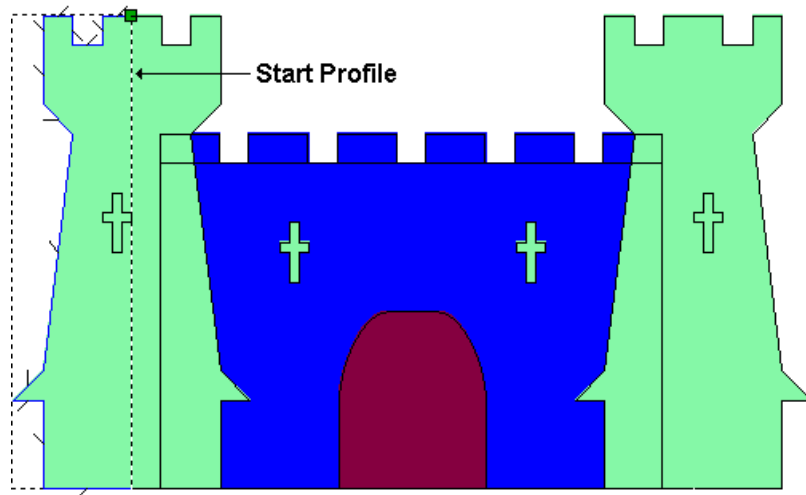

4. In the **Z Scaling Factor** box, define the scaling factor that you want to apply to the start profile in the Z-axis direction. The default value of 1 produces a semi-circular cross-section.
5. Click on the **Next** button. The start profile turns blue.





---

**Tip:** If you want to change any of the settings after you have clicked on the **Next** button, click on the **Back** button to return to the previous page in the **Turn Wizard**.

---

6. Select the relief combination method that you want to use:
  - Click on the **Add** radio button  to add the turned shape to the current relief. For more details, see "Adding to the Relief" on page 326.
  - Click on the **Subtract** radio button  to subtract the turned shape from the current relief. For more details, see "Subtracting from the Relief" on page 328.
  - Click on the **Merge Highest** radio button  to merge the turned shape with the current relief, so that only the highest points of the two show. For details, see "Merging with the Relief" on page 330.
  - Click on the **Merge Lowest** radio button  to merge the turned shape with the current relief, so that only the lowest points of the two show. For details, see "Merging with the Relief" on page 330.
7. Click on the **Turn** button to combine the turned shape with any existing relief in your model.

8. Click on the **3D View** button  in the **2D View** toolbar to display the **3D View** window. You can now see the relief.

In our example, the relief appears in the **3D View** window as follows:

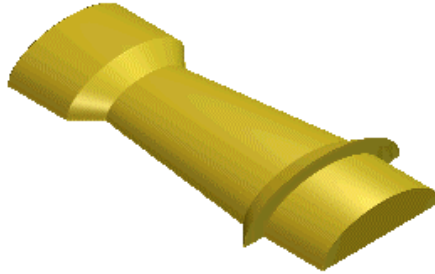

The crenellations within the castle turrets are created by selecting white as the Primary Colour, and then using the

**Zero Relief Under Colour** button  in the **Relief Editing** area. For details, see "Selecting the Primary and Secondary Colours" in the Working with Bitmaps chapter and "Resetting the Relief Height" on page 360.

9. Click on the **2D View** button  in the **3D View** toolbar to return to the **2D View** window.
10. Click on the **Close** button to close the **Turn Wizard**.

## Creating a Two Rail Sweep

You can create a two-rail swept shape using multiple vector objects. The first two vector objects define the lines along which the shape is extruded. They are referred to as the drive rails. You can use any number of vector objects as cross-sections in the shape. Each of the vector objects that you select as cross-sections can be associated to a specific position along each of the drive rails, the vector objects along which the swept shape is extruded. You can also use a vector object to determine the height of the shape in the Z direction.

In the following example, you can see how a shape can be swept along vector objects to form a fish:



Before...

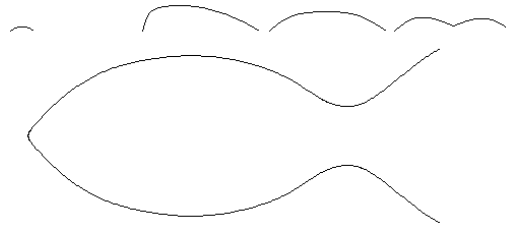

After...

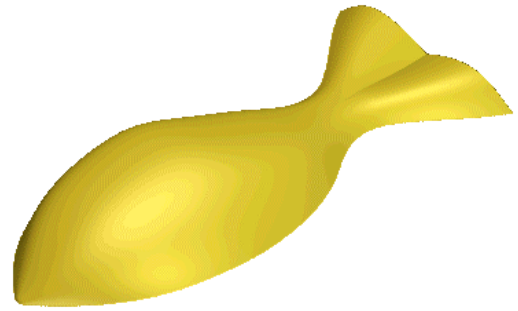

To create a two-rail swept shape:

1. Click on the **Two Rail Sweep** button  in the **Vector Based Relief Creation** area to display the **Two Rail Sweep** page.

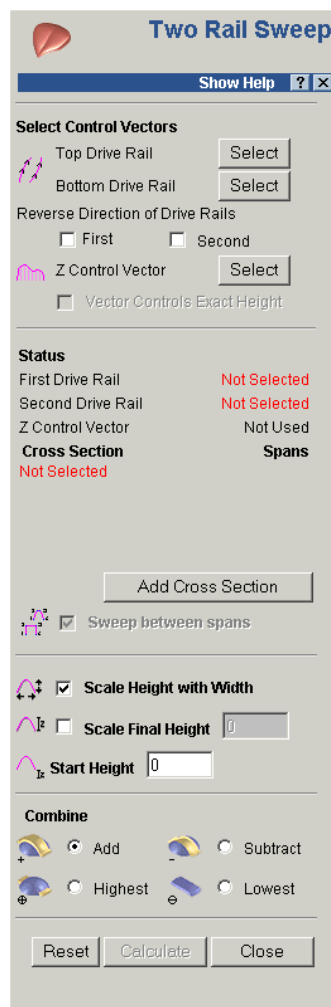

---

**Note:** You can also display the **Two Rail Sweep** page from the Main menu bar. Click on the **Relief** menu, and then on the **Two Rail Sweep...** option.

---

2. Click to select the first vector object along which you want the cross-section to be swept, and then click on the **Select** button for the **Top Drive Rail** in the **Select Control Vectors** area. The selected vector object is referred as the first drive rail. For details, see "Selecting Vectors" in the Working with Vectors chapter.

In the **Status** area, the **First Drive Rail** status changes from **Not Selected** to **Valid**. A red *A* also appears beside the first drive rail in the **2D View** window.

3. Click to select the second vector object along which you want the cross-section to be swept, and then click on the **Select** button for the **Bottom Drive Rail** in the **Select Control Vectors** area. The selected vector object is referred to as the second drive rail.

In the **Status** area, the **Second Drive Rail** status changes from **Not Selected** to **Valid**. A red *B* also appears beside the second drive rail in the **2D View** window.

Arrows appear on the two vector objects selected as the drive rails to indicate their direction.

4. Click to select the open, ungrouped vector object that you want to use as the cross-section in the swept shape, and then click on the **Add Cross Section** button in the **Status** area.

In the **Status** area, *Cross Section 1* is now listed with its status as **Valid**. The number of spans that make up the cross-section are also shown. A red *I* also appears beside the cross-section in the **2D View** window.

If you have selected a closed or grouped vector object as a cross-section, the following message box appears:

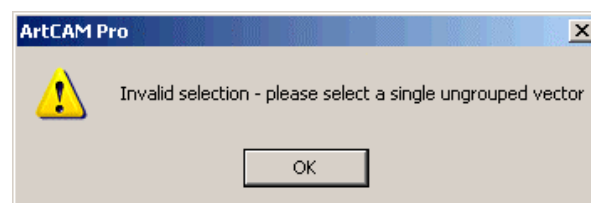

Click on the **OK** button to close the message box, and then repeat this step using an open and ungrouped vector object.

If you want to use multiple cross-sections in the swept shape, hold the **Shift** key down on your keyboard, click to select each of the open, ungrouped vector objects that you want to use, and then click on the **Add Cross Section**

button. In the **Cross Section** area, each of the selected cross-sections is numbered iteratively and its status is shown as **Valid**. Each of the cross-sections selected in the **2D View** window is also numbered iteratively in red.



---

**Note:** When selecting two or more cross-sections, each of the selected open vector objects you use should ideally contain the same number of spans. This will make for a smooth transition in the shape between each cross-section.



---

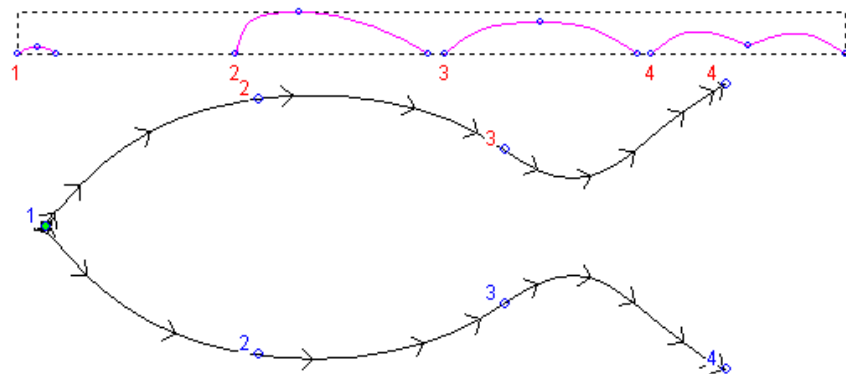

A red number marks the position of each cross section along the first drive rail in the **2D View** window. The position of each cross section along the first drive rail is numbered iteratively.

A blue number marks the position of the each cross section along the second drive rail in the **2D View** window. The position of each cross-section along the second drive rail is numbered iteratively.



If you want to adjust the position of any of the cross-sections along either of the drive rails, for each of them:

- Click on the **Set Position** button .  
The **Set Position** button changes to  and the **Position** label changes to **1st Rail**.
- Click on the position along the first drive rail that you want to use for the cross-section.  
The **1st Rail** label changes to **2nd Rail**.
- Click on the position along the second drive rail that you want to use for the cross-section.  
The **Set Position** button changes to  and the **2nd Rail** label changes to **Position**.

By default, ArtCAM Pro creates a smooth blended shape between each cross-section made up of an equal number of spans. If you would rather a linear blended shape is used, click on the **Smooth Blend** button . The **Linear Blend** button  is displayed in its place.

If you want to cancel the use of any of the selected cross-sections, click on the **Delete** button  for each of the cross-sections that you do not want to use.

If all of the vector objects selected as cross-sections contain the same number of spans, the **Sweep Between Spans** option is activated and selected by default . This instructs ArtCAM Pro to sweep between matching spans.

If you do not want to sweep between matching spans, click to deselect the **Sweep Between Spans** option .

5. Make sure that the direction of the two vector objects that you have selected as drive rails is the same:
  - If you need to reverse the direction of the first drive rail, click to select the **First** option  in the **Reverse Direction of Drive Rails** area.
  - If you need to reverse the direction of the second drive rail, click to select the **Second** option .
6. You are now ready to decide how you want to scale the swept shape. If you want to scale the two-rail swept profile in the Z-axis along its length:
  - Click to select the open vector object that you want to use to control the Z height of the swept shape, and then click on the **Select** button for the **Z Control Vector** in the **Select Control Vectors** area. The selected vector object is referred to as the z modulation curve.

In the **Status** area, the **Z Modulation Curve** status changes from **Not Selected** to **Valid**. A red Z also appears beside the z modulation curve in the **2D View** window.
  - Next, click to select the **Vector Controls Exact Height** option . The **Scale Height with Width** and **Scale Final Height** options are greyed-out.

If you do not want to use a vector object to determine the height of the swept shape, you can select an alternative scaling option:

- To scale the height of the cross-section across the two drive rails in proportion with its width, make sure that the **Scale Height with Width** option is selected .

If you want the height of the cross-section across the two drive rails to remain constant, click to deselect the **Scale Height with Width** option .



---

**Note:** Narrow sections in the swept shape appear low, while wide sections appear high when the **Scale Height with Width** option is selected.

---

- To define the final height of the swept shape before it is combined with any existing relief, click to select the **Scale Final Height** option , and then define the height of the shape in its box.



---

**Note:** If you have selected the **Vector Controls Exact Height** option, then the **Scale Height with Width** and **Scale Final Height** options are greyed-out.

---

7. If you want to add a start height to the two-rail swept shape, define the height in the **Start Height** box. This produces a base that is combined with the swept shape after it has been calculated. The start height is not included in the scaled final height of the swept shape.
8. In the **Combine** area of the page, select the relief combination method that you want to use:
  - Click on the **Add** radio button  to add the two-rail swept shape to the current relief. For more details, see "Adding to the Relief" in the Working with Reliefs chapter of the Reference Manual.
  - Click on the **Subtract** radio button  to subtract the two-rail swept shape from the current relief. For more details, see "Subtracting from the Relief" in the Working with Reliefs chapter of the Reference Manual.

- Click on the **Highest** radio button  to merge the two-rail swept shape with the current relief, so that only the highest points of the two show. For more details, see "Merging with the Relief" in the Working with Reliefs chapter of the Reference Manual.
  - Click on the **Lowest** radio button  to merge the two-rail swept shape with the current relief, so that only the lowest points of the two show. For more details, see "Merging with the Relief" in the Working with Reliefs chapter of the Reference Manual.
9. Click on the **Calculate** button to combine the two-rail swept shape with the existing relief.

In our example, the **Add** option is used.

10. Click on the **3D View** button  in the **2D View** toolbar to display the **3D View** window. You can now see the relief.
11. Click on the **2D View** button  in the **3D View** toolbar to return to the **2D View** window.

In our example, the relief appears in the **3D View** window as follows:

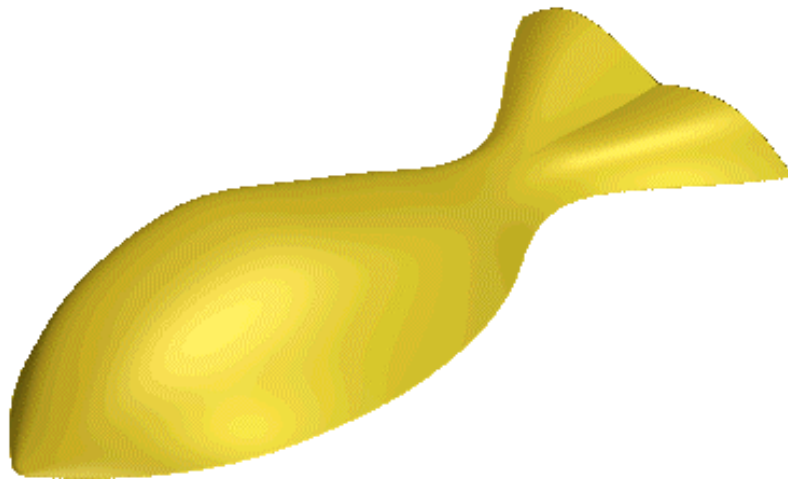

12. Click on the **Close** button to return to the **Assistant's** Home page.

## Creating a Weave Shape

A weave shape is made up of overlapping swept profiles. You can create a weave shape using at least two vector objects.

The vector objects you select for the drive rails must overlap themselves and represent the pattern in the weave shape you want to

create. The last vector object you select defines the cross-section of the weave shape. ArtCAM Pro automatically extrudes the cross-section along the drive rails, scaling its height up and down at each intersection to provide a perfect inter-linked, over-and-under weave effect.

In the following example, you can see how a weave shape is created by extruding it along a vector object in the shape of a weave pattern.

*Before...*

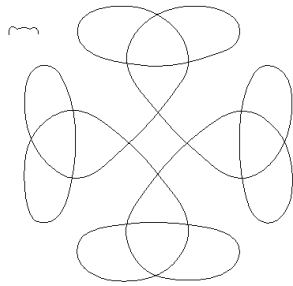

*After...*

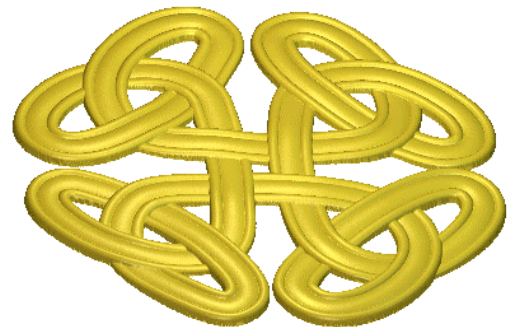

To create a weave shape:

1. Hold the **Shift** key down on your keyboard, and then click to select the vector objects along which you want the cross-section to be extruded. For details, see "Selecting Vectors" in the Working with Vectors chapter. These are referred to as the drive rails.
2. Hold the **Shift** key down, and then click to select the open vector object that you want to use for the cross-section in the weave shape.

In order to begin creating the weave shape in our example, the following vector objects are selected:

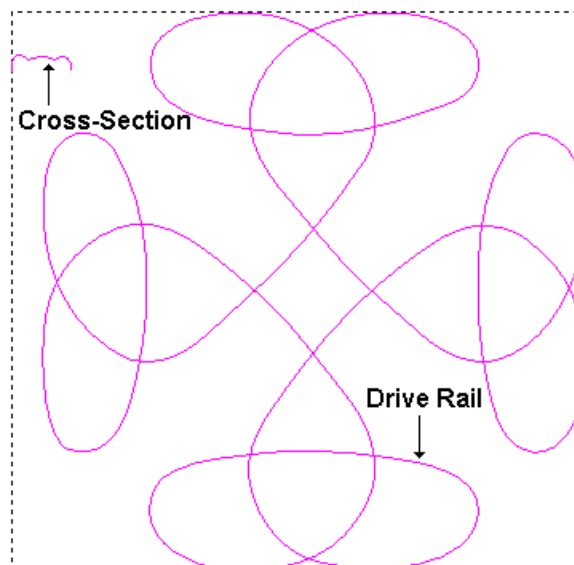

3. Click on the **Weave Wizard** button  in the **Vector Based Relief Creation** area of the **Assistant's** Home page to display the **Weave Wizard**:



---

**Note:** You can also display the **Weave Wizard** from the Main menu bar. Click on the **Relief** menu, and then on the **Weave Wizard...** option.

---

If you try to open the **Weave Wizard** before selecting at least two vector objects, the following error message is displayed:



Click on the **OK** button to close the message box, make sure that you have selected vector objects representing at least one drive rail and a cross-section and then repeat this step.

4. You can now set the length of the section within the drive curve that underlies or overlaps at intersections. This is referred to as the crossover.
- To set the length of the crossover as a multiple of the cross-section's length, click to select the **Relative to**



**cross-section** option , and then define its length in the **Length of crossover** box.

- To set the length of the crossover as an absolute distance, make sure that the **Relative to cross-section** option is deselected , and then define its length in the **Length of crossover** box.

In our example, the **Relative to cross-section** option is selected  and the length of the crossover is set to 4.

5. Define the height of the cross-section where it underlies at an intersection in the **% Depth of underpass** box.

In our example, the **% Depth of underpass** is set to 40.

6. Define the height of the cross-section where it overlaps at an intersection in the **% Height of overpass** box.

In our example, the **% Height of overpass** is set to 20.

7. In the **Corner Shape** area of the page, select the type of corner that you want to use in the cross-section:

- To apply rounded corners to the cross-section, click on the **Round** radio button .
- To apply squared corners to the cross-section, click on the **Square** radio button .

In our example, **Round** corners are selected

8. In the **Combine** area of the page, select the relief combination method that you want to use:

- Click on the **Add** radio button  to add the weave shape to the current relief. For more details, see "Adding to the Relief" on page 326.
- Click on the **Subtract** radio button  to subtract the weave shape from the current relief. For more details, see "Subtracting from the Relief" on page 328.
- Click on the **Highest** radio button  to merge the weave shape with the current relief, so that only the highest points of the two show. For details, see "Merging with the Relief" on page 330.
- Click on the **Lowest** radio button  to merge the weave shape with the current relief, so that only the

lowest points of the two show. For details, see "Merging with the Relief" on page 330.

In our example, the **Add** option is used.

9. Click on the **OK** button to close the **Weave Wizard** and combine the weave shape with any existing relief in your model.
10. Click on the **3D View** button  in the **2D View** toolbar to display the **3D View** window. You can now see the relief.

In our example, the relief appears in the **3D View** window as follows:

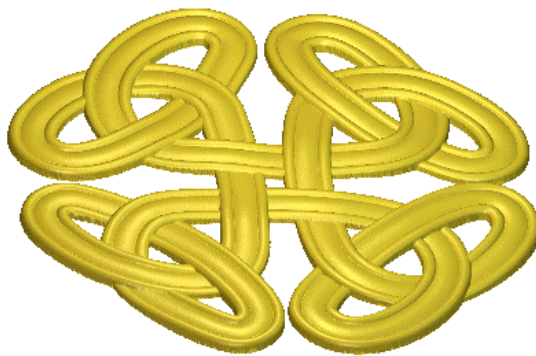

11. Click on the **2D View** button  in the **3D View** toolbar to return to the **2D View** window.

## Creating ISO-FORM Letters

You can create ISO-FORM lettering, a shape of a constant height, from any closed vector object. You can control if the lettering has either a curved or an angled face. You can also control the radius of the corners in the lettering.

An ISO-Form letter is essentially made up of two parts, a **Bottom Height** and a **Top Height**. The former describes the vertical height (side wall) in the base of the letter, while the latter describes the height in the angled or curved cross-section added to its base to complete the letter.

To create ISO-FORM lettering:

1. Click to select the vector text from which you want to create ISO-FORM letters. For details, see "Selecting Vectors" and "Creating Vector Text" in the Working with Vectors chapter.

2. Click on the **ISO-FORM Letters** button  in the **Vector Based Relief Creation** area of the **Assistant's Home page** to display the **Constant Height** dialog box:

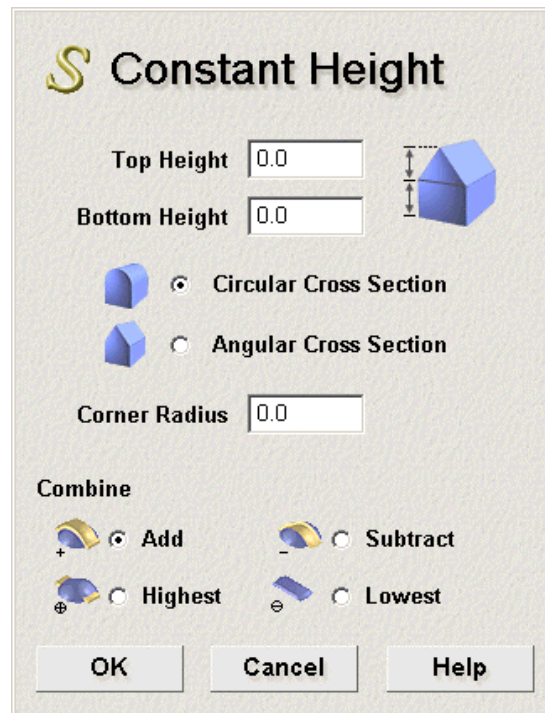

**Note:** You can also display the **Constant Height** dialog box from the Main menu bar. Click on the **Relief** menu, and then on the **ISO-FORM Letters...** option.

3. Define the height of the cross-section in the ISO-FORM letters in the **Top Height** box .
4. Define the height of the base in the ISO-FORM letters in the **Bottom Height** box.
5. Click on either of the radio buttons  to select the type of cross-section that you want to create:
  - **Circular Cross-Section** – This option allows you to create ISO-FORM letters with a curved cross-section.
  - **Angular Cross-Section** – This option allows you to create ISO-FORM letters with an angled-edged cross-section.
6. Define the radius of the corners in your ISO-FORM lettering in the **Corner Radius** box. This allows you to taper all areas of the constant height relief that are of a

smaller radius than that which is defined in the **Corner Radius** box.

In the following example, you can see the difference that defining a corner radius makes to the serifs in this ISO-FORM letter with a constant height of 6 mm and an angular cross-section.

*Corner Radius at 0.0...*

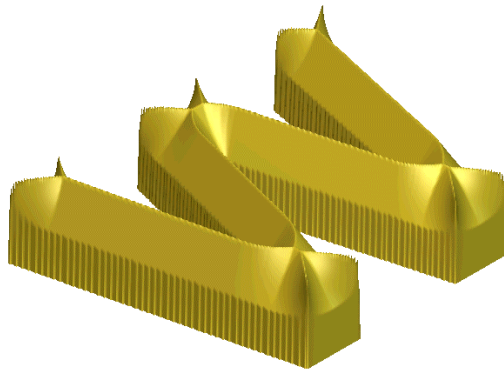

*Corner Radius at 12.0...*

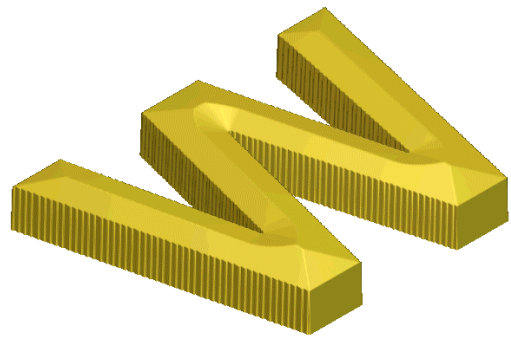

7. In the **Combine** area of the page, select the relief combination method that you want to use:
  - Click on the **Add** radio button  to add the ISO-FORM letters to the current relief. For more details, see "Adding to the Relief" on page 326.
  - Click on the **Subtract** radio button  to subtract the ISO-FORM letters from the current relief. For more details, see "Subtracting from the Relief" on page 328.
  - Click on the **Highest** radio button  to merge the ISO-FORM letters with the current relief, so that only the highest points of the two show. For details, see "Merging with the Relief" on page 330.
  - Click on the **Lowest** radio button  to merge the ISO-FORM letters with the current relief, so that only the lowest points of the two show. For details, see "Merging with the Relief" on page 330.
8. Click on the **OK** button to combine the ISO-FORM letters with any existing relief in your model and return to the **Assistant's** Home page.

---

# Creating a Dome

You can create a concave or convex dome shape and combine it with any existing relief in your model.

To create a dome shape:

1. Click on the **Selection Rectangle** button  in the **File** toolbar. For details, see "Using the Selection Rectangle" in the Working with Vectors chapter.
2. Move the cursor to the position in the model (the white area) in which you want to create the selection rectangle, and then click and drag. Release the mouse button when you have set its size.
3. From the Main menu bar, click on the **Relief** menu, and then on the **Create Dome** option to display the **Create A Dome** dialog box:

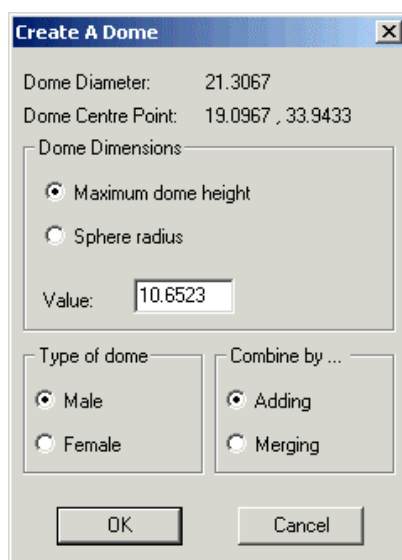

4. In the **Dome Dimensions** area, click on either of the radio buttons  to define the dimensions of the dome:
  - **Maximum dome height** – This option allows you to create a dome at the maximum height relative to the diameter of the dome shown in the **Dome Diameter** area. The shape of the dome represents a complete half-sphere. If you want to reduce the height of the dome, set its maximum height using the **Value** box.

- **Sphere radius** – This option allows you to define the spherical radius of the dome, using the **Value** box.
5. In the **Type of Dome** area, click on either of the radio buttons  to define the type of dome you want to create:
- **Male** – This option allows you to create a convex (raised) dome.
  - **Female** – This option allows you to create a concave (recessed) dome.

*Male Dome...*

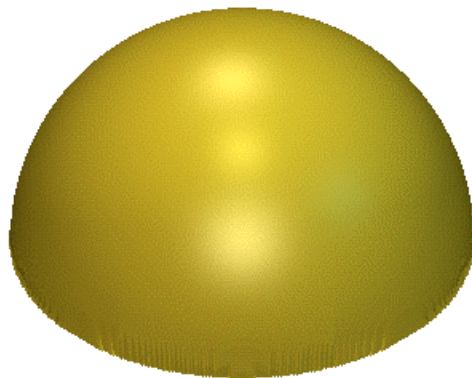

*Female Dome...*

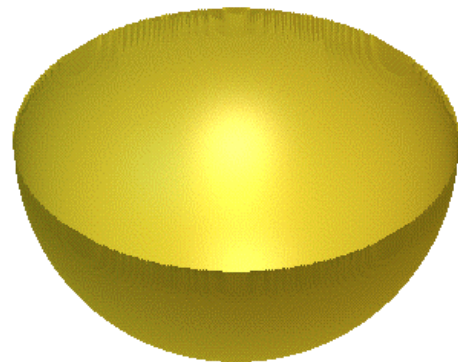

6. In the **Combine By...** area, click on either of the radio buttons  to select how the dome is combined with the existing relief:
- **Adding** – This option allows you to add the dome shape to the current relief. For more details, see "Adding to the Relief" on page 326.
  - **Merging** – This option allows you to merge the dome shape with the current relief, so that only the highest points of the two show. For more details, see "Merging with the Relief" on page 330.
7. Click on the **OK** button to combine the dome with any existing relief in your model and close the **Create A Dome** dialog box.

---

## Creating a Feature

You can combine three different types of feature with the existing relief in a model using a vector object, usually vector text:

- **Raised Feature.** For details, see "Creating a Raised Feature" in the Working with Vectors chapter.
- **Recessed Feature.** For details, see "Creating a Recessed Feature" in the Working with Vectors chapter.
- **Centreline Engraved Feature.** For details, see "Creating a Centreline Engraved Feature" in the Working with Vectors chapter.

A depth or height is attributed to the vector object from which the feature is created. The height is added to, or the depth subtracted from, any existing relief in the model. This forms the shape of the vector object, usually vector text, on the relief surface. The contour of the existing relief is preserved in the feature with which it is combined.

A feature is machined using a **Feature Machining** toolpath. For information on toolpaths, see "Overview" in the Machining Models chapter. For details on creating a **Feature Machining** toolpath, see "Feature Machining" in the Machining Models chapter.

---

## Calculating a Relief

You can calculate a relief from the shape attributes you have assigned to a bitmap colour in the current **2D View** window using one of four different combination methods:

- **Replace** – You can replace the current relief with a shape to create a new relief. For details, see "Replacing the Relief" on page 326.
- **Add** – You can add a shape to the current relief to create a new relief. For details, see "Adding to the Relief" on page 326.
- **Subtract** – You can subtract a shape from the current relief to create a new relief. For details, see "Subtracting from the Relief" on page 328.
- **Merge** – You can merge a shape with the current relief, so that only the highest or the lowest points of the two remain in a new relief. For details, see "Merging with the Relief" on page 330.

These combination methods can be selected from the Main menu bar, by clicking on the **Relief** menu, and then the **Calculate** option.

## Replacing the Relief

You can replace the current relief with a shape to create a new relief.

To replace the current relief with a shape:

1. Create the shape with which you want to replace the current relief. For details, see "Creating a Shape from a Bitmap" on page 286.
2. Click on the **Replace Relief** button  in the **Relief Operations** area of the **Assistant's** Home page to replace the current relief with the shape.



---

**Note:** You can also replace the current relief with a shape using the Main menu bar. Click on the **Relief** menu, followed by the **Calculate > Replace** option.

---

The **Calculating Relief** progress bar appears beneath the **2D View** window. You can cancel the relief replacement process at any time by clicking on the  button.

3. Click on the **3D View** button  in the **2D View** toolbar to display the **3D View** window.

You can also replace the current relief with a shape using the **Project** page:

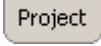
1. Click on the **Project** tab  to display the **Project** page.
2. Right-click on the current **2D View** listed in the **Views** area to display the context menu. Click on the **Calculate Relief** option, followed by the **Replace** option. For further details, see "Viewing Model Information" in the Working with Models chapter.

## Adding to the Relief

You can add a shape to the current relief to create a new relief.

To add a shape to the current relief:

1. Create the shape that you want to add to the current relief. For details, see "Creating a Shape from a Bitmap" on page 286.

In the following example, a blue circle is drawn in a model using the **Paint** tool:



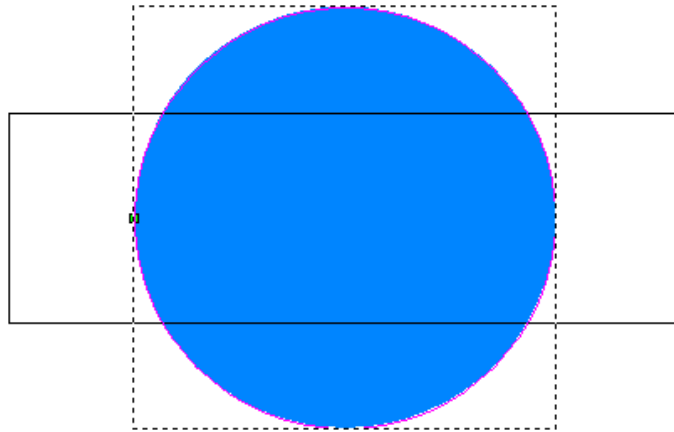

A rounded shape is then applied to the circle using the **Shape Editor** dialog box, as you can see by looking at the Colour Palette below the **2D View** window:



The calculated relief appears in the **3D View** window as follows:

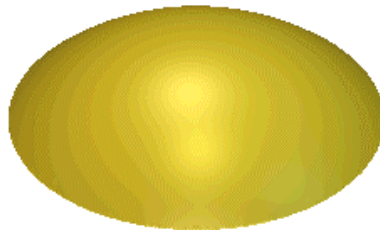

The rectangular vector object is then flood-filled in red:

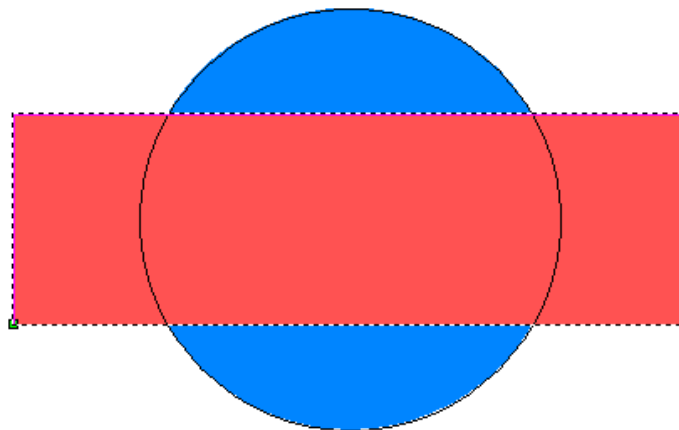

A plane is applied to the rectangle using the **Shape Editor** dialog box, as you can see by looking at the Colour Palette below the **2D View** window:



2. Click on the **Add Relief** button  in the **Relief Operations** area of the **Assistant's** Home page to add the shape to the current relief.



---

**Note:** You can also add a shape to the current relief using the Main menu bar. Click on the **Relief** menu, followed by the **Calculate > Add** option.

---

3. Click on the **3D View** button  in the **2D View** toolbar to display the **3D View** window.

In our example, the plane has been added to the existing relief to create the following new relief:

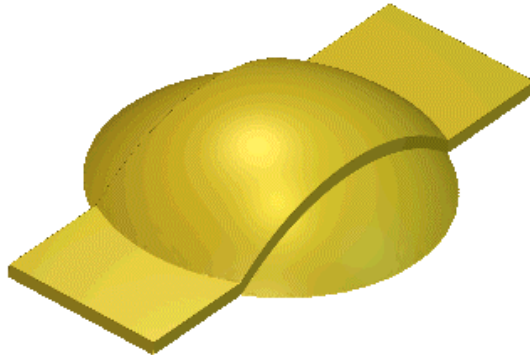

You can also add a shape to the current relief using the **Project** page:

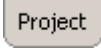
1. Click on the **Project** tab  to display the **Project** page.
2. Right-click on the current **2D View** listed in the **Views** area to display the context menu. Click on the **Calculate Relief** option, followed by the **Add** option. For further details, see "Viewing Model Information" in the Working with Models chapter.

## Subtracting from the Relief

You can subtract a shape from the current relief to create a new relief

To subtract a shape from the current relief:

1. Create the shape that you want to subtract from the current relief. For details, see "Creating a Shape from a Bitmap" on page 286.

In the following example, a blue circle is drawn in the model using the **Paint** tool:

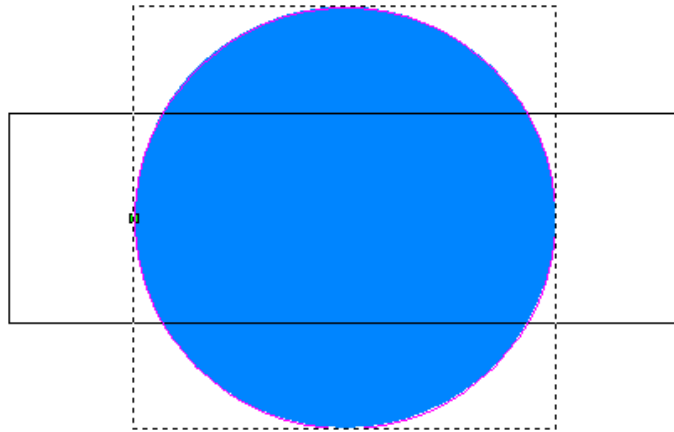

A rounded shape is then applied to the circle using the **Shape Editor** dialog box, as you can see by looking at the Colour Palette below the **2D View** window:



The calculated relief appears in the **3D View** window as follows:

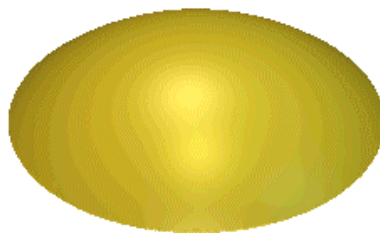

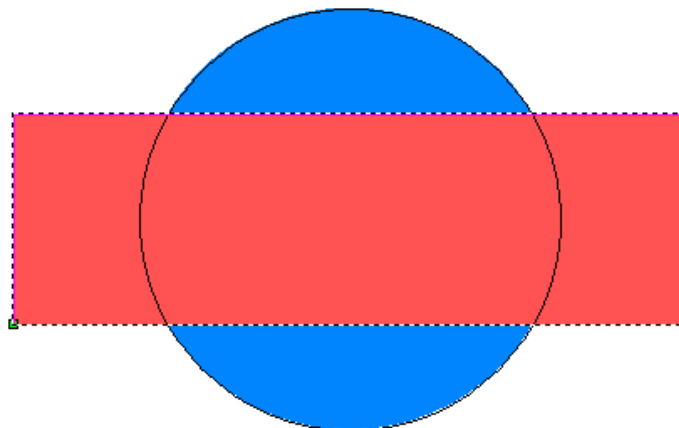

The rectangular vector object is then flood-filled in red:



A plane is applied to the rectangle using the **Shape Editor** dialog box, as you can see by looking at the Colour Palette below the **2D View** window:



2. Click on the **Subtract Relief** button  in the **Relief Operations** area of the **Assistant's** Home page to subtract the shape from the current relief.
3. Click on the **3D View** button  in the **2D View** toolbar to display the **3D View** window.

In our example, the plane has been subtracted from the existing relief, to create the following new relief:

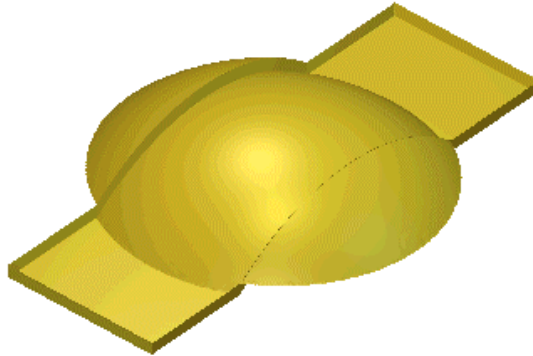

You can also subtract a shape from the current relief using the **Project** page:

1. Click on the **Project** tab  to display the **Project** page.
2. Right-click on the current **2D View** listed in the **Views** area to display the context menu. Click on the **Calculate Relief** option, followed by the **Subtract** option. For further details, see "Viewing Model Information" in the Working with Models chapter.

## Merging with the Relief

You can merge a shape with the current relief, so that only the highest points of the two remain in a new relief. Alternatively, you can merge a shape with the current relief, so that only the lowest points of the two remain in a new relief.

To merge a shape with the current relief:

1. Create the shape that you want to merge with the current relief. For details, see "Creating a Shape from a Bitmap" on page 286.

In the following example, a blue circle is drawn in the model using the **Paint** tool:

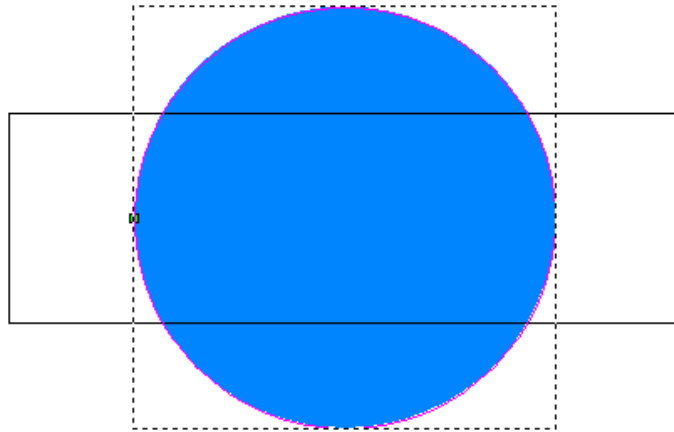

A rounded shape is then applied to the circle using the **Shape Editor** dialog box, as you can see by looking at the Colour Palette below the **2D View** window:



The calculated relief appears in the **3D View** window as follows:

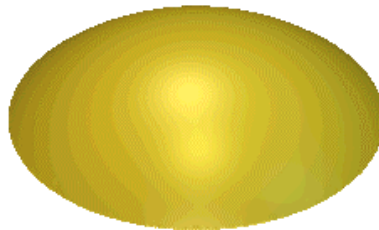

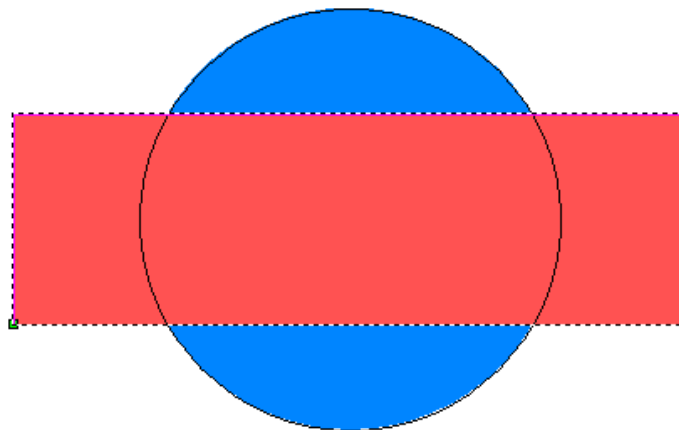

The rectangular vector object is then flood-filled in red:



A plane is applied to the rectangle using the **Shape Editor** dialog box, as you can see by looking at the Colour Palette below the **2D View** window:



2. You can now merge the shape with the current relief:

- Click on the **Merge High** button  in the **Relief Operations** area of the **Assistant's** Home page to merge the shape with the current relief, so that only the highest points of the two show.
- Click on the **Merge Low** button  in the **Relief Operations** area of the **Assistant's** Home page to merge the shape with the current relief, so that only the lowest points of the two show.



---

**Note:** You can also merge a shape with the current relief using the Main menu bar. Click on the **Relief** menu, followed by the **Calculate > Merge Highest** or **Merge Lowest** option.

---

3. Click on the **3D View** button  in the **2D View** toolbar to display the **3D View** window.

The examples below show the different results achieved by using the **Merge High** and **Merge Low** options:

*Merge High...*

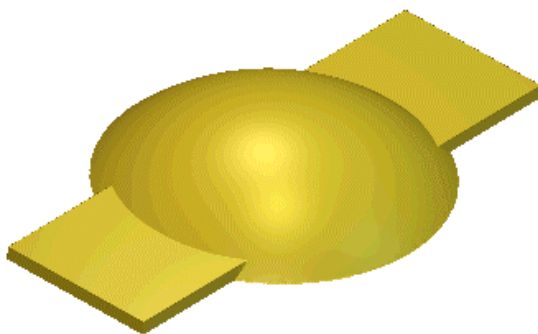

*Merge Low...*

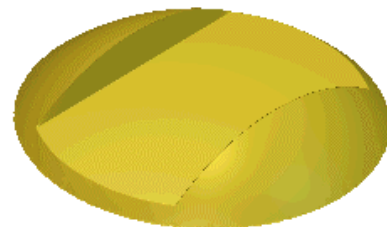

You can also merge a relief using the **Project** page:

1. Click on the **Project** tab  to display the **Project** page.
2. Right-click on the current **2D View** listed in the **Views** area to display the context menu. Click on the **Calculate Relief** option, followed by the **Merge Highest** or **Merge Lowest** option. For further details, see "Viewing Model Information" in the Working with Models chapter.

---

# Transforming and Manipulating Reliefs

You can use the buttons in the **Relief Operations** and **Relief Editing** areas of the **Assistant's** Home page, along with the **Relief** menu options in the Main menu bar, to transform and manipulate the relief that you have created or want to import.

You can transform and manipulate a relief in the following ways:

- Using 3D clipart. For details, see "Using 3D Clipart" on page 333.
- Copying and Pasting a Relief. For details, see "Copying and Pasting a Relief" on page 344.
- Pasting a relief along a vector. For details, see "Pasting a Relief along a Vector" on page 349.
- Inverting a relief. For details, see "Inverting a Relief" on page 351.
- Smoothing a relief. For details, see "Smoothing a Relief" on page 352.
- Scaling the relief height. For details, see "Scaling the Relief Height" on page 354.
- Scaling to volume. For details, see "Scaling to Volume" on page 356.
- Mirroring a relief. For details, see "Mirroring a Relief" on page 357.
- Mirror merging a relief. For details, see "Mirror Merging a Relief" on page 358.
- Offsetting a relief. For details, see "Offsetting a Relief" on page 359.
- Resetting a relief. For details, see "Resetting a Relief" on page 360.
- Resetting the relief height. For details, see "Resetting the Relief Height" on page 360.

## Using 3D Clipart

You can use the **3D Clipart** dialog box to resize and transform clipart relief, and select the way in which it is combined with the current relief.



---

**Tip:** You can find a range of clipart relief samples on the ArtCAM Pro installation CD.

---

The **3D Clipart** dialog box is displayed when you use either of the following options in ArtCAM Pro:

- Pasting a relief along a vector. For details, see "Pasting a Relief along a Vector" on page 349.
- Loading a relief. For details, see "Loading a Relief" on page 363.

The **3D Clipart** dialog box appears as follows:

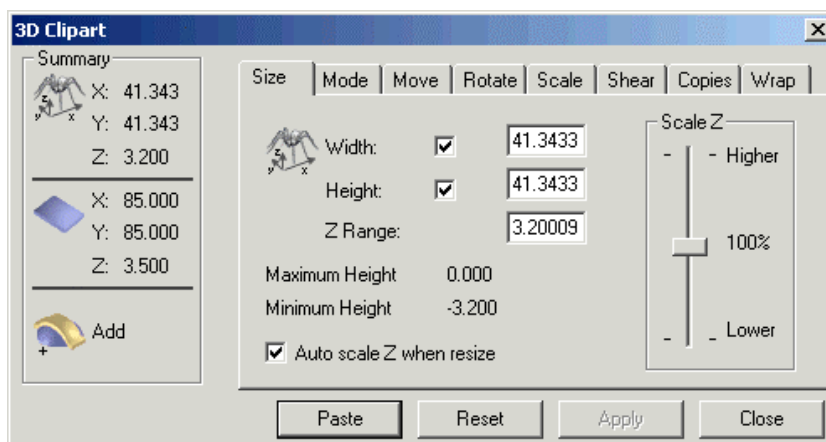

There are eight tabs in the **3D Clipart** dialog box. Each tab contains a page of settings that allow you to edit the clipart relief and control how it is combined with the existing relief.

## ***Resizing the Clipart Relief***

You can scale the clipart relief in the Z direction and/or set its height and width.

To resize the clipart relief:

1. Click on the **Size** tab to display its settings.
2. You can scale the relief in the Z direction using any of the following methods:
  - Type its new Z height in the **Z Range** box.
  - Click and drag on the **Scale Z** slider. Click and drag upwards to increase the height of the relief in the Z direction. Click and drag downwards to reduce the height of the relief in the Z direction.



- Click to select the **Auto scale Z when resize** option . This option scales the relief in the Z direction whenever its width or height is changed.
3. To set the width and/or height of the clipart relief:
    - Type its new height and/or width in the **Width** and/or **Height** box. If you want to scale the X and Y axes differentially, make sure that both the **Width** and **Height** options are selected  before you type a value in each of the boxes.
  4. Click on the **Apply** button to adjust the clipart relief according to your settings.

### ***Combining the Reliefs***

You can combine the clipart relief with the current relief in one of four ways: **Add**, **Subtract**, **Merge Highest** or **Merge Lowest**. You can also set the position in which the clipart relief is combined with the existing relief.

To combine clipart relief with the current relief:

1. Click on the **Mode** tab to display its settings.
2. Click on the **Paste Mode** radio button  that you want to use. For details, see "Calculating a Relief" on page 325.
3. Define the height at which you want to combine the imported relief with the current relief in the **Start Height** box.
4. To calculate the height you have defined from the Z zero position in the relief, click on the **From Zero** radio button . To calculate the height that you have defined from the current position in the relief, click on the **From Current** radio button .
5. To paste a vector outline in the shape of the imported relief in the **2D View** window, click to select the **Copy outline** option .
6. Click on the **Apply** button to adjust the clipart relief according to your settings.

### ***Positioning the Clipart Relief***

You set the position of the clipart relief.

To reposition the clipart relief:

1. Click on the **Move** tab to display its settings.
2. To move the imported relief in the Y axis direction, you can either:
  - Type a value in the **Move Y origin by** box.
  - Click and drag on the vertical slider.
3. To move the imported relief in the X axis direction, you can either:
  - Type a value in the **Move X origin by** box.
  - Click and drag on the horizontal slider.
4. Click on the **Apply** button to adjust the clipart relief according to your settings.

### ***Rotating the Clipart Relief***

You can rotate and/or mirror the clipart relief along the X or Y axis around the centre of the clipart relief or a defined position in the ArtCAM model.

To rotate and/or mirror the clipart relief:

1. Click on the **Rotate** tab to display its settings.
2. To rotate the clipart relief, you can either:
  - To rotate the clipart relief about its centre, define the angle in the **Rotate by angle** box, or click and drag on the slider to set the angle.
  - To rotate the clipart relief about a specific position in the model, click to deselect the **Rotate about centre** option , and then define the new origin of rotation.

If you have deselected the **Rotate about centre** option, you can define the origin of rotation using either of the following methods:

- Click on the **Cursor** button, move the  cursor over the position that you want to use, and then click.
  - Type the X and Y co-ordinates of the point in the **X** and **Y** boxes.
3. You can now mirror the clipart relief along the X or Y axis:
    - To mirror the clipart relief along the X-axis, click on the **Horizontal** button.

- To mirror the imported relief along the Y-axis, click on the **Vertical** button.
4. Click on the **Apply** button to adjust the clipart relief according to your settings.

## ***Scaling the Clipart Relief***

You can scale the clipart relief to a percentage of its original size.

To scale the clipart relief:

1. Click on the **Scale** tab to display its settings.
2. To scale the clipart relief, you can either:
  - Type a percentage of the clipart relief's current size in the **New scale %** box.
  - Click and drag on the slider. Click and drag to the right to increase the size of the clipart relief. Click and drag to the left to reduce it.
3. Click on the **Apply** button to adjust the clipart relief according to your settings.



---

**Tip:** If scaling to 1% or 200% does not produce big enough or small enough results, click on the **Apply** button. This scales the relief to the new size and resets the **New Scale %** to 100. You can now repeat the scaling process to further increase or reduce its size.

---

## ***Shearing the Clipart Relief***

Shearing can be visualised by thinking of an image superimposed onto a flexible rubber sheet. If you hold the sides of the sheet and move them up and down in opposite directions, the image undergoes a spatial stretching known as shearing. You can shear the clipart relief both horizontally and vertically.

To shear the clipart relief:

1. Click on the **Shear** tab to display its settings.
2. To shear the clipart relief horizontally, you can either:
  - Type a value in the **Shear in X axis** box.
  - Click and drag on the horizontal slider.
3. To shear the clipart relief vertically, you can either:
  - Type a value in the **Shear in Y axis** box.

- Click and drag on the vertical slider.
4. Click on the **Apply** button to adjust the clipart relief according to your settings.

## ***Copying the Clipart Relief***

You can make a single copy of the clipart relief, or multiple copies in either a grid or circular pattern.

To make copies of the clipart relief:

1. Click on the **Copies** tab to display its settings.
2. Select how you want to copy the clipart relief.
3. Click on the **Apply** button to copy the clipart relief according to your settings.

## ***Wrapping the Clipart Relief***

Clipart relief can be projected onto an existing relief in a model using the four standard relief combination options: **Add**, **Subtract**, **Merge Highest** and **Merge Lowest**. For details, see "Calculating a Relief" on page 325. Using this method of combining clipart relief with the current relief often causes distortion to the shape of the clipart relief.

You can preserve its original shape when pasting by wrapping it around one or more of the axes in the model during the relief combination process.

In the following example, a lizard clipart relief pasted onto a dome is shown:

*Projected...*

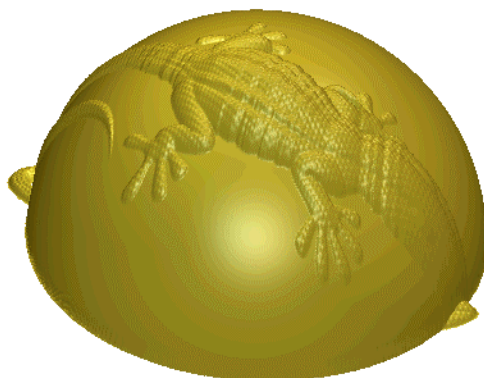

*Wrapped Radially...*



You can see how the lizard relief is smeared across the dome when projected onto it. When pasted radially, its original size and shape is maintained.

To wrap the clipart relief:

1. Click on the **Wrap** tab to display its options.
2. In the **Wrap Type** area, click to select the wrapping option that you want to use:
  - **Project** – This option allows you to paste the clipart relief onto the relief surface.



---

**Warning:** Using the **Project** method of wrapping clipart relief onto an existing relief can cause distortion to its original shape.

---

- **Radial** – This option allows you to wrap the clipart relief around a spherical shape that is curved in both the X and Y-axes.
  - **Wrap in X** – This option allows you to wrap the clipart relief around a cylindrical shape that is curved around the X-axis.
  - **Wrap in Y** – This option allows you to wrap the clipart relief around a cylindrical shape that is curved around the Y-axis.
3. In the **Wrap Origin** area, define the origin around which the relief will be wrapped. You can use any of the following methods:



---

**Note:** If the **Project** option is selected in the **Wrap Type** area, the **Wrap Origin** area is greyed-out.

---

- Click on any of radio buttons  on the rectangle diagram. The X and Y co-ordinates of the chosen origin appear in the **X** and **Y** boxes.
  - Type the X and Y co-ordinates of the origin in the **X** and **Y** boxes.
  - Click on the **Use Mouse** option , followed by the **Start** button. Move the cursor to the position in the **2D View** window that you want to use as the origin, and then click to select. The X and Y co-ordinates of the origin appear in the **X** and **Y** boxes.
4. Click on the **Apply** button to wrap the clipart relief around the existing relief. The vector outline in the **2D View** window representing the clipart relief is corrected to compensate for the distortion.

In our example, the lizard clipart relief's vector outline appears as follows before and after it has been radially wrapped:

*Projected...*

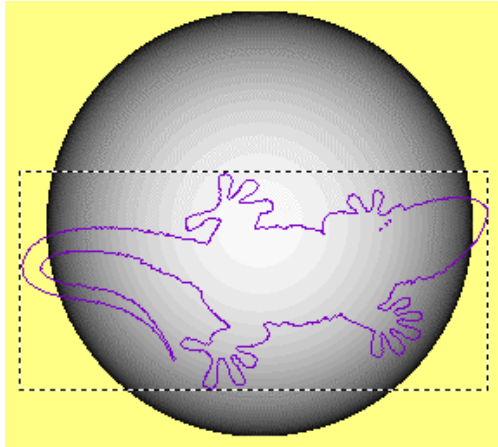

*Radially Wrapped...*

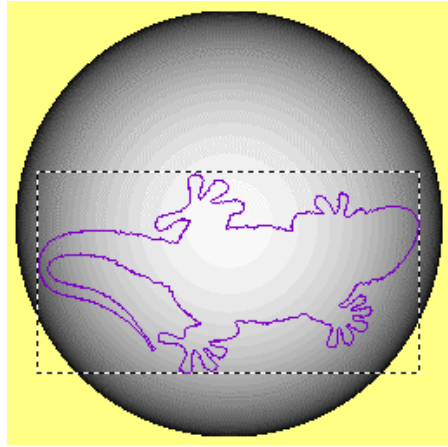

### 3D Clipart Example

In the following example, you can see how the **3D Clipart** dialog box is used to transform, resize and position an imported relief to create a new relief.

1. Click on the **Load Relief** button  in the **Relief Operations** area of the **Assistant's** Home page to display the **Open** dialog box:

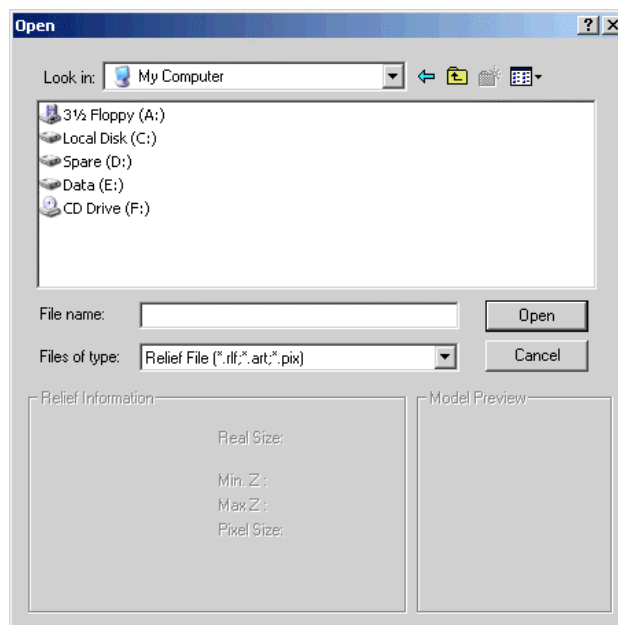

2. Click to select the **Pend\_frm.rlf** file in the ArtCAM Pro 8.0\Examples\Overview directory and then click on the **Open** button to display the **Load Relief** dialog box:



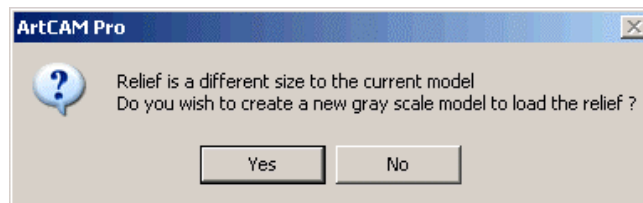

If the loaded relief is larger or smaller than the existing relief, the following message box appears:

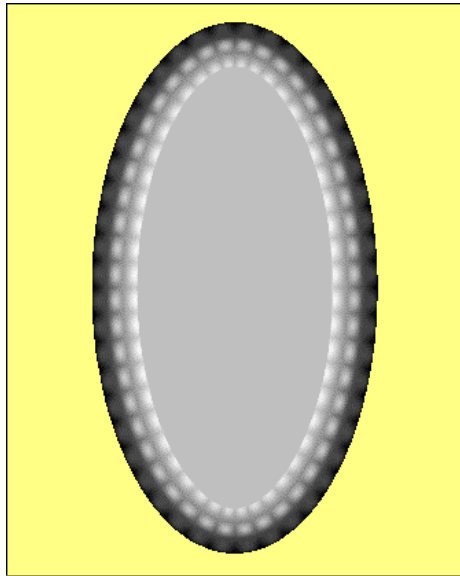

Click on the **Yes** button. The new model is created, and a greyscale image of the loaded relief is shown in the **2D View** window.

3. Click on the **Replacing** radio button , and then click on the **OK** button to close the **Load Relief** dialog box and load the relief.
4. Click to select the **2D View** window. A greyscale image of the imported pendant relief appears as follows:



5. Click on the **Load Relief** button  again to display the **Open** dialog box.
6. Click to select the **Lady.rlf** file in the ArtCAM Pro 8.0\Examples\Overview directory, and then click on the **Open** button to display the **Load Relief** dialog box.
7. Click on the **Pasting** radio button , and then on the **OK** button to close the **Load Relief** dialog box and display the **3D Clipart** dialog box:

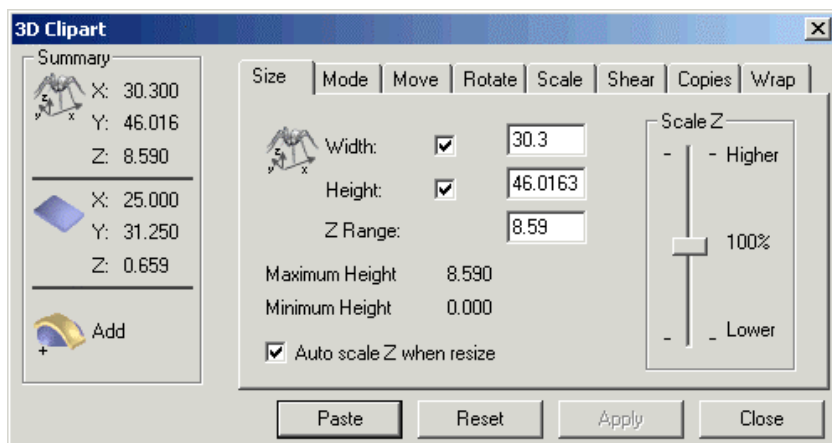

A vector object in the shape of a lady's head appears in the **2D View** window to represent the area of the lady relief. The imported lady relief is much larger than the pendant relief, and therefore has to be resized in order to fit within it.

8. You are now ready to scale the lady relief. In the **3D Clipart** dialog box, click on the **Scale** tab, click and drag on the sliders to reduce the size of the lady relief to fit inside



the centre of the pendant relief, and then click on the **Apply** button.

9. You are now ready to position the lady relief. Click on the **Move** tab, click and drag on the sliders to position the vector object inside the centre of the pendant relief, and then click on the **Apply** button. The lady relief should now appear something like the image shown below:

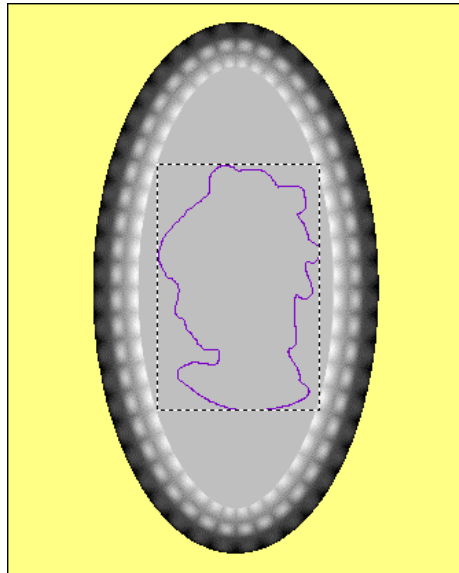

10. You are now ready to resize the lady relief. Click on the **Size** tab, click and drag on the **Scale Z** slider downwards to set the **Maximum Height** of the lady relief to approximately 0.500 mm, and then click on the **Apply** button.
11. Click on the **Mode** tab, and then on the **Add** radio button  to select how the lady relief is combined with the pendant relief.
12. Click on the **Paste** button to paste the lady relief onto the pendant relief, thus creating a new relief.
13. Click on the **Close** button to close the **3D Clipart** dialog box.
14. Click on the **3D View** button  in the **2D View** toolbar to display the **3D View** window. The new relief should appear something like the image shown below:



## Copying and Pasting a Relief

You can copy an area within a relief defined by a vector object, and then paste it elsewhere within the relief using the Relief Envelope Distortion tool. For further information, see "Relief Envelope Distortion" on page 378.

You can adjust the shape and position of the copied relief prior to pasting using a distortion envelope. You can paste the copied relief anywhere in the model area, along a curved vector object, or between two curved vector objects.

For example, you can see how a grapevine relief has been redesigned by copying and pasting different areas:

*Before...*

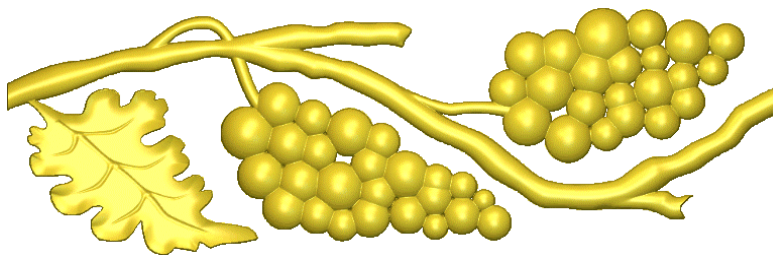

*After...*

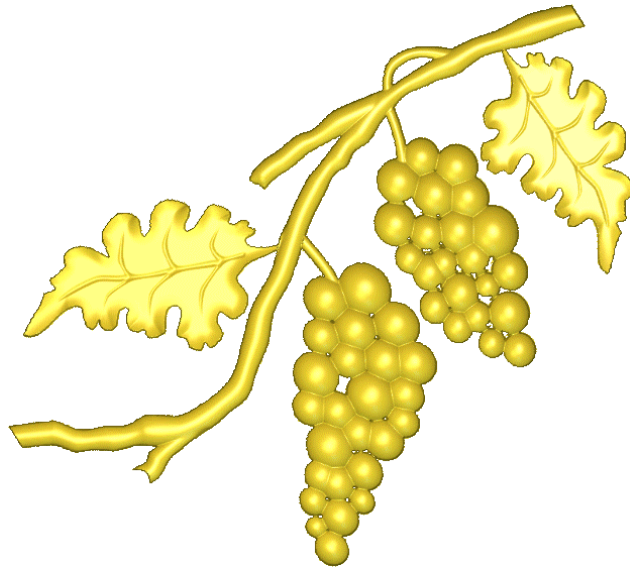

To copy and paste a relief:

1. From the **2D View** window, click to select the vector object that marks the boundary of the relief that you want to copy. For details, see "Selecting Vectors" in the Working with Vectors chapter.
2. From the Main menu bar, click on the **Edit** menu, followed by the **Copy Relief** option to copy the relief to the ArtCAM clipboard.

In the following example, we will copy the relief shown below:

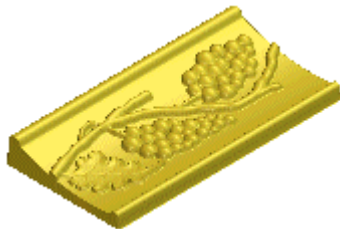

3. Click on the **Paste** option to create a preview copy of the relief about the model's origin, enclosed by a distortion envelope. The **Relief Envelope Distortion** page is displayed in the **Assistant** window.

In the **Original Relief** area, the **Keep original relief (Copy)** radio button is selected by default  and the **Replace original relief (Cut)** radio button is greyed-out.

4. You can use the tools in the **Editing Mode** area to edit the shape or position of the copied relief, create a vector in the

shape of its outline and display it in greyscale. For details, see "Relief Envelope Distortion" on page 378.

In the image below, you can see a grape relief before and after it has been distorted:

*Copied Relief...*

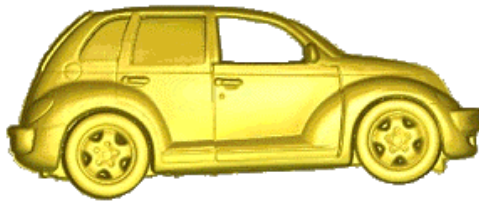

*Distorted Relief...*



5. If you want to paste the relief along a single curved vector object:
  - First, click to select the **Use existing curve(s)** option to display its settings .
  - Next, click to select the **Wrap along single curve** radio button . The **Wrap between 2 curves** settings are greyed-out.
  - If you want to specify the width of the relief, click to select the **specify envelope width** option  and then define its width in the **Width** box.
  - Click to select the curved vector object along which you want to paste the copied relief, and then click on the **Select Curve** button. For details, see "Selecting Vectors" in the Working with Vectors chapter.

In our example, we will use a single curved vector object as shown below:

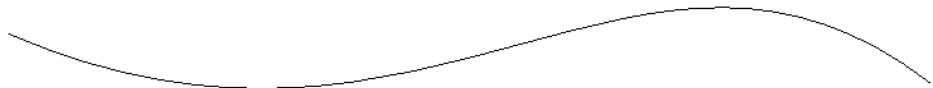

6. If you want to paste the relief between two curved vector objects:
  - Click to select the **Use existing curve(s)** option to display its settings .
  - Make sure that the **Wrap between 2 curves** radio button is selected .
  - Click to select the curved vector object along which you want to paste the copied relief, and then click on

the **Select Top Curve...** button. For details, see "Selecting Vectors" in the Working with Vectors chapter.

- Click to select the curved vector object along which you want to paste the copied relief, and then click on the **Select Bottom Curve...** button. For details, see "Selecting Vectors" in the Working with Vectors chapter.
7. In the **Number of copies** area, click to select the method that you want to use when pasting the relief:
- If you want to stretch the relief along the selected vector object(s), click to select the **One - Stretch to Fit** radio button .
  - If you want ArtCAM Pro to calculate the optimum number of copies of the relief that should be created along the selected vector object(s), click to select the **Many - Best Fit** radio button .
  - If you want to create a specific number of copies of the relief along the selected vector object(s), click to select the **Many - Specific number of copies** radio button  and then define the number of copies in the **Copies** box.

In our example, we select the last option and instruct ArtCAM Pro to create six copies of the relief along the selected vector object.

8. Click on the **Apply** button to position the relief distortion envelope along the selected vector object(s).

If you are in **Greyscale View** mode, a greyscale image of the pasted relief is shown in the **2D View** window. For details, see "Greyscale View" in the ArtCAM Pro Layout chapter. A distortion envelope is also attached to the selected vector object(s).

In our example, the distortion envelope appears as follows:

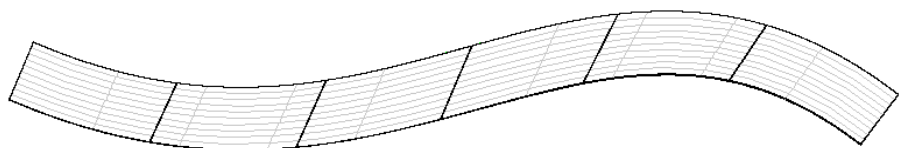

You can see that the distortion envelope has six sections, one for each of the copies of the relief that we want to paste along the selected vector object.

9. In the **Combine** area, click to select the relief combination method that you want to use.
  - To add the copied relief to the existing relief, click on the **Add** option. For more details, see "Adding to the Relief" on page 326.
  - To subtract the copied relief from the existing relief, click on the **Subtract** option. For more details, see "Subtracting from the Relief" on page 328.
  - To merge the copied relief with the existing relief, so that only the highest points of the two remain, click on the **Merge Highest** option. For more details, see "Merging with the Relief" on page 330.
  - To merge the copied relief with the existing relief, so that only the lowest points of the two remain, click on the **Merge Lowest** option. For more details, see "Merging with the Relief" on page 330.

In our example, we will add the copied relief to the existing relief.

10. Click on the **Paste** button to combine the copied relief with the existing relief.

In the following image, you can see how the pasted relief appears as shown in the **3D View** window:



Further examples of pasting relief copies along a curved vector object are shown as follows:

*Vector Curves...*

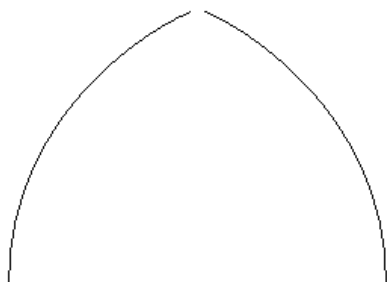

*Pasted Relief...*



*Vector Curve...*

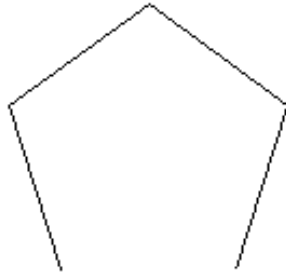

*Pasted Relief...*



*Vector Curve...*



*Pasted Relief...*



11. Click on the **Finish** button to return to the **Assistant's** Home page.

## Pasting a Relief along a Vector

You can import a relief into ArtCAM Pro, edit the relief and then paste multiple copies of it along a selected curved vector object.

To paste a relief along a curved vector object:

1. Click to select the curved vector object along which you want to paste the imported relief. For details, see "Selecting Vectors" in the Working with Vectors chapter.
2. Click on the **Paste Relief Along Vector** button  in the **Vector Based Relief Creation** area of the **Assistant's** Home page to display the **Open** dialog box:

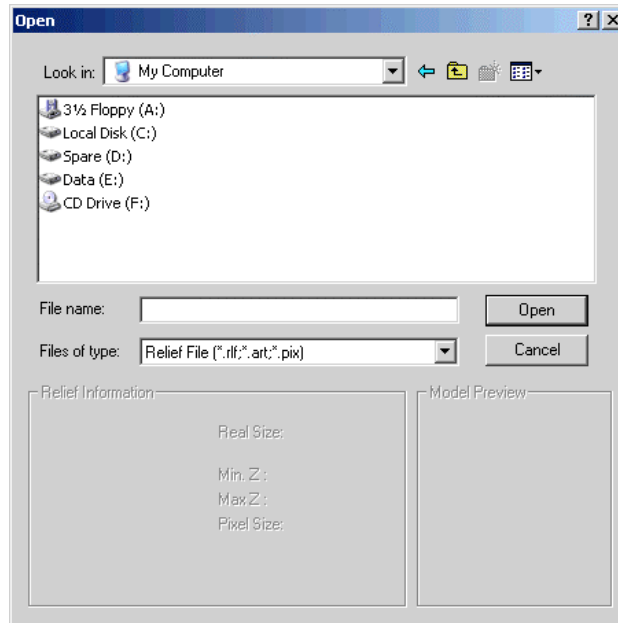

3. Click on the **Look in** list box and select the directory where the relief file is stored.
4. Click to select the relief file that you want to import. The file name appears in the **File name** box and the relief dimensions appear in the **Relief Information** area.
5. Click on the **Open** button to import the selected relief. A preview image of the relief appears in the **2D View** window about the origin of your model. The **Paste Along A Curve** page is displayed in the **Assistant** window and the **3D Clipart** dialog box also appears:

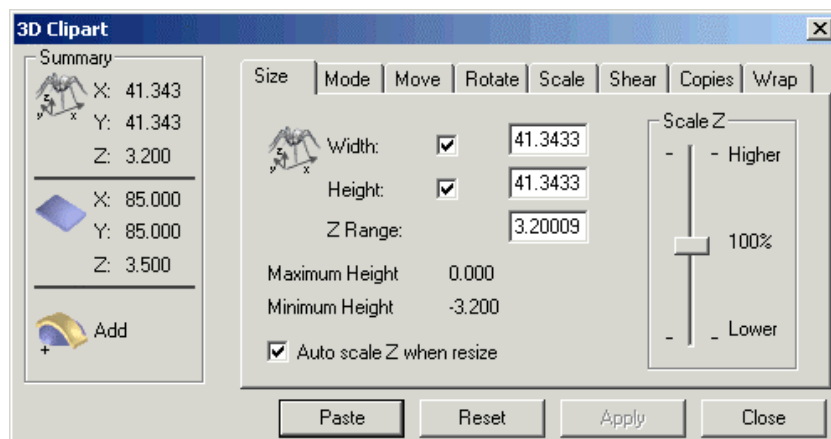

6. You can use the **3D Clipart** dialog box to edit the imported relief, and control the way in which it is combined with the existing relief. For details, see "Using 3D Clipart" on page 333.
7. Click on the **Apply** button in the **3D Clipart** dialog box to adjust the relief according to your settings.



8. You can now use the **Settings** area of the **Paste Along A Curve** page to adjust the size of each consecutive copy that is pasted along the selected vector object, and the spacing between them:
  - To set the spacing between each copy as a percentage of the relief width, type a value in the **Spacing (S)** box.
  - To set the size of the first pasted copy as a percentage of the relief width, type a value in the **Start size (B)** box.
  - To set the size of the last pasted copy as a percentage of the relief width, type a value in the **Final size (E)** box.



---

**Note:** If you type a value in the **Start size (B)** and **Final size (E)** boxes, each consecutive copy of the relief pasted along the selected vector object is scaled proportionately.

---

- If you want the copies of the relief to be pasted evenly along the selected vector object(s), make sure that the **Adjust to fit exactly** option is selected .

9. Click on the **Paste** button on the **Paste Along A Curve** page to paste the relief along the selected vector object.



---

**Warning:** Do not click on the **Paste** button in the **3D Clipart** dialog box if you want to paste the relief along the selected vector object(s).

---



---

**Note:** To undo this action, press the **Ctrl + Z** keys on your keyboard.

---

10. If you do not want to change the way that the copies of the relief have been pasted along the selected vector object, click on the **Close** button in the **3D Clipart** dialog box.
11. Click on the **Close** button on the **Paste Along A Curve** page to return to the **Assistant's** Home page.

## Inverting a Relief



You can invert the existing relief in two ways:

- In the Z-axis only, without any mirroring.

- In the Z-axis, and mirror left to right.

Either or these options allow you turn a concave shape into a convex shape, and vice versa.

To invert a relief in the Z axis only:

1. Click on the **Invert Relief Z Only** button  in the **Relief Editing** area of the **Assistant's** Home page. The relief is inverted in the Z-axis only.
2. Click on the **3D View** button  in the **2D View** toolbar to display the **3D View** window. You can view the inverted relief.

To invert a relief in the Z-axis and mirror left to right:

1. Click on the **Invert Relief – Male/Female** button  in the **Relief Editing** area of the **Assistant's** Home page. The relief is inverted in the Z-axis, and it is also mirrored left to right.



---

**Note:** You can also invert the relief in the Z-axis and mirror left to right from the Main menu bar. Click on the **Relief** menu, and then on the **Invert > Male/Female** option.

---

The inverted relief is mirrored to allow you to produce matching top and bottom halves when machining a model or create a mould from a male model.



---

**Note:** All engraved features on the relief remain as defined. They are added to or subtracted from the relief.

---

2. Click on the **3D View** button  in the **2D View** toolbar to display the **3D View** window. You can view the inverted relief.

## Smoothing a Relief

You can remove surface irregularities that might appear on a relief after it has been calculated. You can smooth the whole surface, or a specific area of the relief.

To smooth the whole relief:

1. Click on the **Smooth Relief** button  in the **Relief Editing** area of the **Assistant's** Home page to display the **Smooth Relief** dialog box:



---

**Note:** You can also display the **Smooth Relief** dialog box from the Main menu bar. Click on the **Relief** menu, and then on the **Smooth...** option.

---

2. Click on either of the arrows  joined to the **Smoothing Passes** box to set the number of smoothing passes over the selected relief.



---

**Tip:** It is better to increase and apply the number of smoothing passes gradually, checking the results of each additional smoothing pass in the **3D View** window.

---

3. Click on the **Apply** button to close the **Smooth Relief** dialog box and smooth the whole relief. The **Working** dialog box appears during the smoothing process:

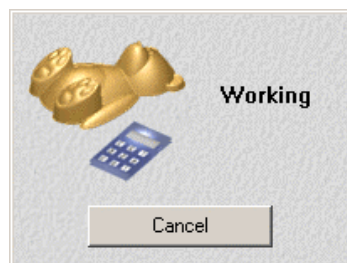

To smooth a specific area of the relief:

1. Click on the **Smooth Relief** button  in the **Relief Editing** area of the **Assistant's** Home page to display the **Smooth Relief** dialog box.

2. You can either use a vector object or bitmap colour to define the area of the relief that you want to smooth. If you want to use a vector object:

- Click to select the vector object from the **2D View** window, and then on the **Selected Vector** radio button .

If you want to use a bitmap colour:

- Select the Primary Colour from the Colour Palette beneath the **2D View** window, and then click on the **Selected Colour** radio button .

3. Click on either of the arrows  adjoined to the **Smoothing Passes** box to set the number of smoothing passes over the selected relief.

4. Click on the **Apply** button to close the **Smooth Relief** dialog box and smooth the area of the relief defined by the currently selected vector object or Primary Colour. The **Working** dialog box appears during the smoothing process:

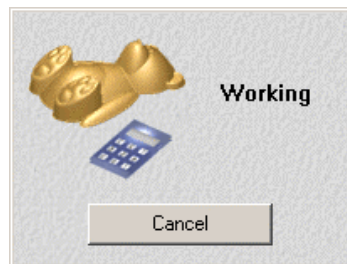

## Scaling the Relief Height

You can scale the whole surface, or a specific area of the relief.

To scale the height of the whole relief:

1. Click on the **Scale Relief Height** button  in the **Relief Editing** area of the **Assistant's** Home page to display the **Scale Relief Height** dialog box:



The current height of the relief is shown in the **Current Height** area of the dialog box.



---

**Note:** You can also display the **Scale Relief Height** dialog box from the Main menu bar. Click on the **Relief** menu, and then on the **Scale...** option.

---

2. To set the new height of the whole relief, you can use either of the following methods:
  - Click and drag on the slider. Click and drag upwards to increase the height of the relief. Click and drag downward to reduce it. Its new height appears in the **New Height** box.
  - Type its new height in the **New Height** box.
3. If the relief that you are scaling contains fine detail:
  - First, click to select the **Preserve Detail** option .
  - Next, define the maximum depth of the detail that you want to keep in the **Detail To Preserve** box.
  - Finally, set the new height of the detail in the **New Detail Height** box.

ArtCAM Pro scales the detail independently of the height specified in the **New Height** box and restores it to the relief after the overall scaling process is complete.

4. Click on the **OK** button to close the **Scale Relief Height** dialog box and scale the relief height.

To scale a specific area of the relief:

1. Click on the **Scale Relief Height** button  in the **Relief Editing** area of the **Assistant's** Home page to display the **Scale Relief Height** dialog box.
2. You can either use a vector object or bitmap colour to define the area of the relief that you want to scale in height. If you want to use a vector object:
  - Click to select the vector object from the **2D View** window, and then on the **Selected Vector** radio button . For details, see "Selecting Vectors" in the Working with Vectors chapter.

If you want to use a bitmap colour:

- Select the Primary Colour from the Colour Palette beneath the **2D View** window, and then click on the **Selected Colour** radio button . For details, see "Selecting the Primary and Secondary Colours" in the Working with Bitmaps chapter.



---

**Warning:** If you select a vector object or bitmap colour that does not represent an area of the model with underlying relief, the **New Height** box in the **Scale Relief Height** dialog box is greyed-out. This indicates that there is no relief in which to scale the height.

---

3. If the area of the relief that you are scaling contains fine detail:
  - First, click to select the **Preserve Detail** option .
  - Next, define the maximum depth of the detail that you want to keep in the **Detail To Preserve** box.
  - Finally, set the new height of the detail in the **New Detail Height** box.

ArtCAM Pro scales the detail independently of the height specified in the **New Height** box and restores it to the relief after the overall scaling process is complete.

4. Click on the **OK** button to close the **Scale Relief Height** dialog box and scale the relief height.

## Scaling to Volume

You can scale an ArtCAM model to an exact volume.

To scale an open model to an exact volume:

1. From the Main menu bar, click on the **Relief** menu and then on the **Volume** option to display the **Scale To Volume** page in the **Assistant** window.

The current size of your model is shown in the **Model Size** area. Its height in the Z direction is shown in the **Model Z Height** area. Its volume is shown in the **Current Volume** area, according to the units of measurement you are using.

2. Click on the **Volume Units** list box, followed by the units of measurement that you want to use.

If you are using millimetres, you can select either of the following options:

- **Cubic mm** – Click on this option to define the volume in cubic millimetres.
- **Cubic cm** – Click on this option to define the volume in cubic centimetres.

If you are using inches, you can select either of the following options:

- **Cubic Inches** – Click on this option to define the volume in cubic inches.
- **Cubic Feet** – Click on this option to define the volume in cubic feet.

3. Define the new volume for the model in the **Enter New Volume** box.
4. If you want to scale the model in the Z direction only, click to select the **Scale in Z Only** option .
5. Click on the **Apply** button to scale the model.
6. Click on the **Finish** button to return to the **Assistant's** Home page.

## Mirroring a Relief

You can reverse the direction of a relief from its original position both horizontally and vertically.

To mirror the relief horizontally:

- From the Main menu bar, click on the **Relief** menu, and then on the **Mirror > Mirror Horizontal** option.

To mirror the relief vertically:

- From the Main menu bar, click on the **Relief** menu, and then on the **Mirror > Mirror Vertical** option.

## Mirror Merging a Relief

You can copy and mirror different halves of a relief. This allows you to create repetitive symmetrical designs very quickly, and means that you now only need to create a partial relief in order to output a complete relief design.

For example, you can create a full weave pattern relief using a partial weave pattern relief occupying only a quarter of the model area in two steps:

(1). *Original Weave Relief...*





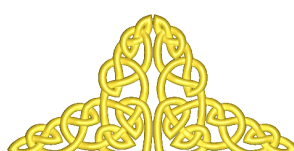

(2). *Mirror Relief from Left to Right...*



(3). *Mirror Relief from Top to Bottom...*



To mirror the relief currently shown in one half of the model area over to its opposite half:

1. Click on the **Mirror Merge Relief** button  in the **Relief Operations** area of the **Assistant's** Home Page to display the **Mirror Merge Relief** page.
2. Click on the button associated with how you want to mirror the relief:
  - Click on the  button to mirror the relief from the left side of the model area to the right.
  - Click on the  button to mirror the relief from the right side of the model area to the left.
  - Click on the  button to mirror the top half of the model area to the bottom half.



- Click on the  button to mirror the bottom half of the model area to the top.
3. Click on the **Close** button to return to the **Assistant's** Home page.

## Offsetting a Relief

You can create a new relief by applying an offset to the existing relief. This allows you to add or subtract material from the surface of both male and female reliefs.

To create an offset relief:

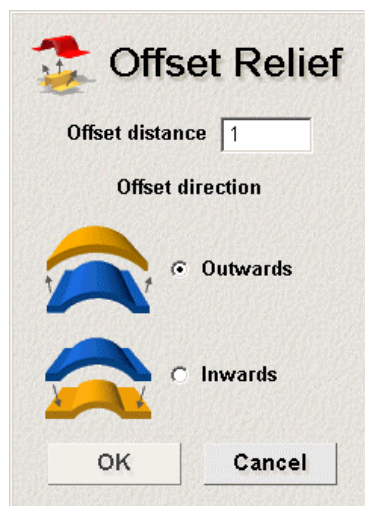

1. Click on the **Offset Relief** button  in the **Relief Editing** area of the **Assistant's** Home page to display the **Offset Relief** dialog box:



---

**Note:** You can also display the **Offset Relief** dialog box from the Main menu bar. Click on the **Relief** menu, and then on the **Offset...** option.



---

2. Define the distance you want to set the offset relief from the existing relief in the **Offset distance** box.
3. Click on either of the radio buttons  to select the **Offset direction** you want to use:
4. Click on the **OK** button to calculate the offset relief and close the **Offset Relief** dialog box.
5. Click on the **3D View** button  in the **2D View** toolbar to view the new relief.

## Resetting a Relief

You can reset the whole relief to zero, effectively removing it.



To reset the relief to zero:

1. Click on the **Reset Relief** button  in the **Relief Operations** area of the **Assistant's** Home page.
2. Click on the **3D View** button  in the **2D View** toolbar to display the **3D View** window. You can now see that the relief has been reset to zero.
3. Click on the **2D View** button  in the **3D View** toolbar to return to the **2D View** window.

## Resetting the Relief Height

You can reset the height of the relief under the current Primary Colour to zero, and vice versa.

To reset the height of the relief to zero in all areas under the current Primary Colour:

1. Select the Primary Colour from the Colour Palette beneath the **2D View** window. For details, see "Selecting the Primary and Secondary Colours" in the Working with Bitmaps chapter. The Primary Colour represents the areas of the relief that you want to reset to zero.
2. Click on the **Zero Relief Under Colour** button  in the **Relief Editing** area of the **Assistant's** Home page.
3. Click on the **3D View** button  in the **2D View** toolbar to display the **3D View** window. You can now see that all areas of the relief under the current Primary Colour have been reset to zero.

To reset the height of the whole relief to zero, except in those areas under the current Primary Colour:

1. Select the Primary Colour from the Colour Palette beneath the **2D View** window. The Primary Colour represents the areas of the relief that you do not want to reset to zero.
2. Click on the **Keep Under Colour** button  in the **Relief Editing** area of the **Assistant's** Home page.



---

**Note:** You can also reset the height of the whole relief to zero, except in those areas under the current Primary Colour, from the Main menu bar. Click on the **Relief** menu, and then on the **Keep Under Colour** option.

---

3. Click on the **3D View** button **3D** in the **2D View** toolbar to display the **3D View** window. You can now see that all areas of the relief not under the current Primary Colour have been reset to zero.

---

## Managing and Editing Reliefs

You can use the buttons in the **Relief Operations** and **Relief Editing** areas of the **Assistant's** Home page, along with the **Relief** menu options in the Main menu bar, to manage and edit a relief that you have created.

You can manage and edit a relief in the following ways:

- Saving a relief. For details, see "Saving a Relief" on page 362.
- Loading a relief. For details, see "Loading a Relief" on page 363.
- Calculating the surface area. For details, see "Calculating the Surface Area" on page 366.
- Displaying the calculation time. For details, see "Displaying the Calculation Time" on page 367.
- Adding a draft angle. For details, see "Adding a Draft Angle" on page 368.
- Creating a triangle mesh. For details, see "Creating a Triangle Mesh" on page 368.
- Creating a cross-section. For details, see "Creating a Cross-Section" on page 370.
- Creating an angled plane. For details, see "Creating an Angled Plane" on page 371.
- Blending 3D shapes. For details, see "Blending 3D Shapes" on page 374.
- Relief Envelope Distortion. For details, see "Relief Envelope Distortion" on page 378.

- Fading a relief. For details, see "Fading a Relief" on page 386.
- Creating a Ring. For details, see "Creating a Ring" on page 390.
- Adding texture to a relief. For details, see "Adding Texture to a Relief" on page 390.
- Sculpting a relief. For details, see "Sculpting a Relief" on page 397.
- Removing holes from the relief surface. For details, see "Removing Holes in the Relief Surface" on page 402.
- Creating a greyscale image from a relief. For details, see "Creating a Greyscale Image from a Relief" on page 402.
- Rotating the relief or the triangle mesh. For details, see "Rotating a Relief or Triangle Mesh" on page 402.

## Saving a Relief

You can save a relief as an ArtCAM relief file (\*.rlf):

1. Click on the **Save Relief** button  in the **Relief Operations** area of the **Assistant's** Home page to display the **Save As** dialog box:

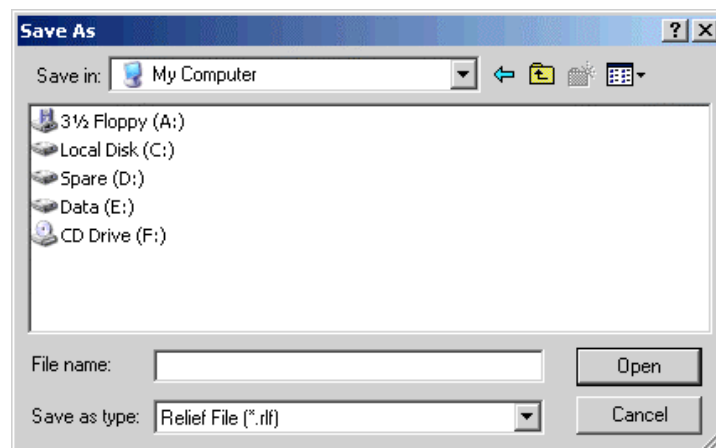

2. Click on the **Save in** list box and select the directory where you want to save the relief.
3. Type a name for the relief in the **File name** box.
4. Click on the **Save** button to save the relief.

## Loading a Relief

You can load a relief file (\*.rlf, \*.art, \*.pix), and then combine it with the existing relief in a model, or use it to replace the existing relief altogether.

To load a relief:

1. Click on the **Load Relief** button  in the **Relief Operations** area of the **Assistant's** Home page to display the **Open** dialog box:

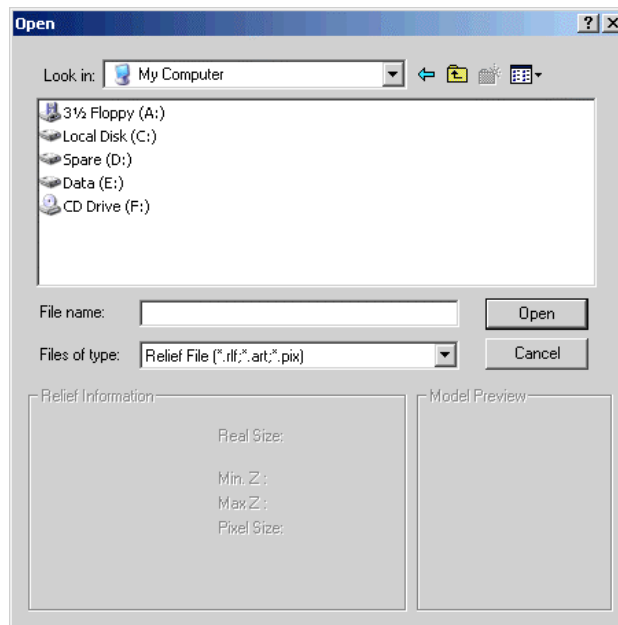

2. Click on the **Look in** list box and select the directory where the relief file that you want to load is stored.
3. Click to select the relief file that you want to load.
4. Click on the **Open** button to display the **Load Relief** dialog box:









5. Select how you want to use the loaded relief by clicking on one of the **Combine with existing relief by...** radio buttons :



---

**Warning:** If the pixel size of the relief that you want to load does not equal the pixel size of the existing relief, only the **Replacing** and **Pasting** options are available in the **Load Relief** dialog box.

---

- To replace the existing relief with the relief you have chosen to load, click on the **Replacing** radio button . For more details, see "Replacing the Relief" on page 326.
  - To add the relief you have chosen to load to the existing relief, click on the **Adding** radio button . For more details, see "Adding to the Relief" on page 326.
  - To subtract the relief you have chosen to load from the existing relief, click on the **Subtracting** radio button . For more details, see "Subtracting from the Relief" on page 328.
  - To merge the relief you want to load with the existing relief, so that only the highest points of the two remain, click on the **Merging Highest** radio button . For more details, see "Merging with the Relief" on page 330.
  - To merge the relief you want to load with the existing relief, so that only the lowest points of the two remain, click on the **Merging Lowest** radio button . For more details, see "Merging with the Relief" on page 330.
  - To paste the relief you have chosen to load onto the existing relief, click on the **Pasting** radio button . For details, see "Using 3D Clipart" on page 333.
6. Click on the **OK** button to combine the loaded relief with the existing relief according to the method selected in the previous step. The new relief is shown in the **3D View** window.

If you have chosen the **Replace** option and the loaded relief is larger or smaller than the existing relief, the following message box appears:

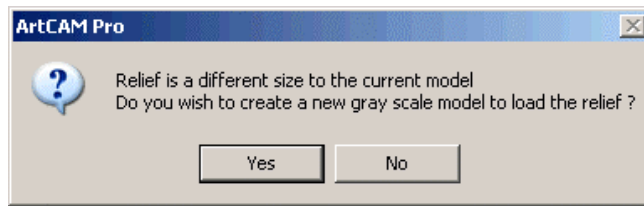

If you want to create a new model click on the **Yes** button. If you have not recently saved the current model, a message box appears giving you the option to save any changes made to the existing model. Click on the **Yes** button to save these changes, or on the **No** button to close the model without saving them first. The new model is created, and a greyscale image of the loaded relief is shown in the **2D View** window.

If the pixel size of the relief that you have chosen to load does not equal the pixel size of the existing relief, the following message box appears:

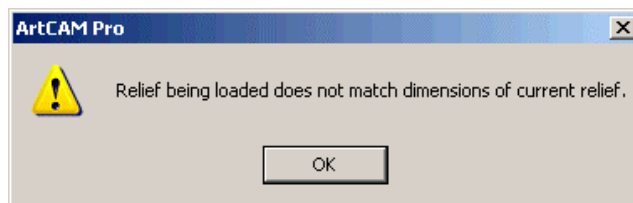

Click on the **OK** button to close the message box, and then repeat these steps.

If you selected the **Pasting** option in the previous step, the **3D Clipart** dialog box is displayed:

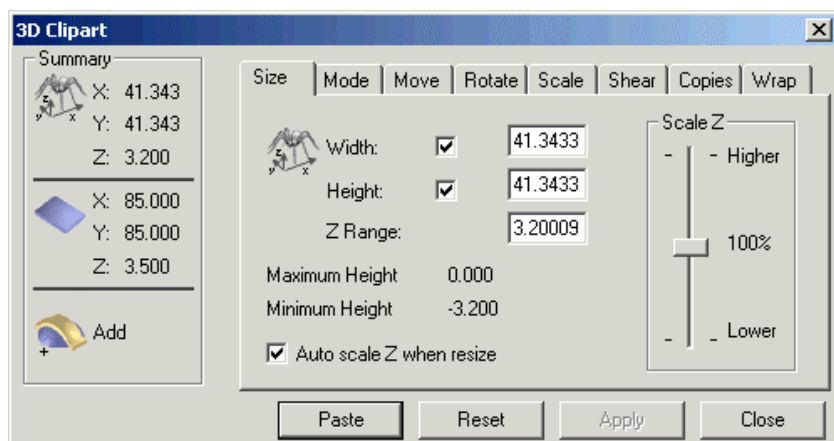

You can use the **3D Clipart** dialog box to edit the relief you have loaded, and control the way in which it is combined with the existing relief. A preview image of the relief also appears in the **2D View** window about the origin of your model. For details on how to use the **3D Clipart** dialog box, see "Using 3D Clipart" on page 333.

You can also load a relief in the following way:

1. From the Main menu bar, click on the **Relief** menu, followed by the **Load** option, and then on the relief combination option that you want to use:
  - To replace the existing relief with the relief you have chosen to load, click on the **Replace** option. For more details, see "Replacing the Relief" on page 326.
  - To add the relief you have chosen to load to the existing relief, click on the **Add** option. For more details, see "Adding to the Relief" on page 326.
  - To subtract the relief you have chosen to load from the existing relief, click on the **Subtract** option. For more details, see "Subtracting from the Relief" on page 328.
  - To merge the relief you want to load with the existing relief, so that only the highest points of the two remain, click on the **Merge Highest** option. For more details, see "Merging with the Relief" on page 330.
  - To merge the relief you want to load with the existing relief, so that only the lowest points of the two remain, click on the **Merge Lowest** option. For more details, see "Merging with the Relief" on page 330.
  - To paste the relief you have chosen to load onto the existing relief, click on the **Pasting** option. For details, see "Using 3D Clipart" on page 333.
  - To scale the existing relief by the relief you have chosen to load, click on the **Multiply** option.



---

**Note:** In order for the **Multiply** option to produce a feasible relief you should load a relief with a **Max Z** height of between 0 and 1.

---

## Calculating the Surface Area

To calculate the surface area of the whole relief or the area of the relief under the current Primary Colour:

1. Make sure that the current Primary Colour represents the area of the relief of which you want to find out the surface



area. For details, see "Selecting the Primary and Secondary Colours" in the Working with Bitmaps chapter.

2. From the Main menu bar, click on the Relief menu, and then the **Surface Area Under Colour** option to display the **Relief Surface Area** dialog box:

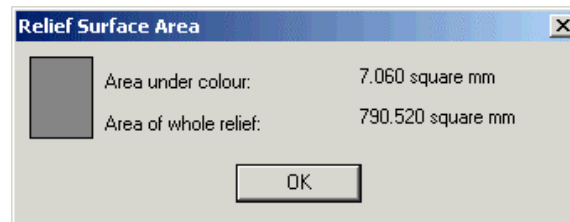

The surface area of the relief under the current Primary Colour and the surface area of the whole relief is shown in mm<sup>2</sup> or inches<sup>2</sup>.

3. Click on the **OK** button to close the **Relief Surface Area** dialog box.

## Displaying the Calculation Time

You can automatically find out how long it has taken to create a relief created using shapes generated from bitmaps and which were calculated using the relief combination buttons in the **Relief** toolbar. For details, see "Creating a Shape from a Bitmap" on page 286 and "Calculating a Relief" on page 325.

To view information about the calculation process immediately after calculating a relief:

1. From the Main menu bar, click on the **Relief** menu, and then on the **Display Calculation Time** option.

At the end of each relief calculation, the **ArtCAM Pro** dialog box appears showing the start time/date, end time/date and duration of the relief calculation process:

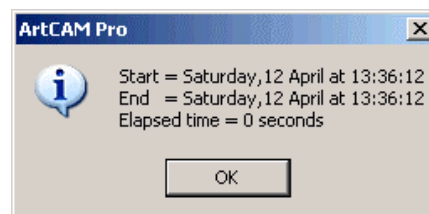

Click on the **OK** button to close the dialog box.

If you no longer want to view this information, repeat this step to deselect the **Display Calculation Time** option in the **Relief** menu.

## Adding a Draft Angle

You can remove any vertical or near vertical faces that can be seen on a relief surface by adding a constant draft angle to it.





To add a draft angle to a relief:

1. From the Main menu bar, click on the **Relief** menu, and then on the **Add Draft...** option to display the **Add Draft Angle** page in the **Assistant** window.
2. Define the draft angle you want to add to the existing relief in the **Enter Draft Angle In Degrees** box.
3. Click on the **Apply** button to add the draft angle to the relief.
4. Click on the **Finish** button to return to the **Assistant's** Home page.

## Creating a Triangle Mesh

You can create a triangle model of the existing relief, otherwise known as a **Triangle Mesh**. This is made up of a series of triangle facets that represent a closed three-dimensional shape. Three point coordinates and a direction describe each facet.

To create a triangle mesh from the existing relief:

1. Click on the **Create Triangle Mesh** button  in the **Relief Operations** area of the **Assistant's** Home page to display the **Mesh Creator** page.
2. In the **Triangulation Parameters** area, define the tolerance in the **Tolerance** box to control the number of triangles generated.
3. In the **Back Face** area, click on one of the radio buttons  to select the type of shape that you want to use to close the triangle mesh:
  - **None (Open Triangulation)** – To leave the shape open, click on this radio button .
  - **Close With A Flat Plane** – To create a back face equivalent to a Z height of zero, click on this radio button .

- **Close With Inverted Front** – To create a back face that is the inverted shape of the relief surface, click on this radio button .
- **Use Relief From File** – To create the back face from a relief file (\*.rlf, \*.art, or \*.pix), providing that pixel size of the relief that you have chosen to load equals the pixel size of the existing relief, click on this radio button . If you select this option:

First, click on the **Load** button to display the **Open** dialog box:

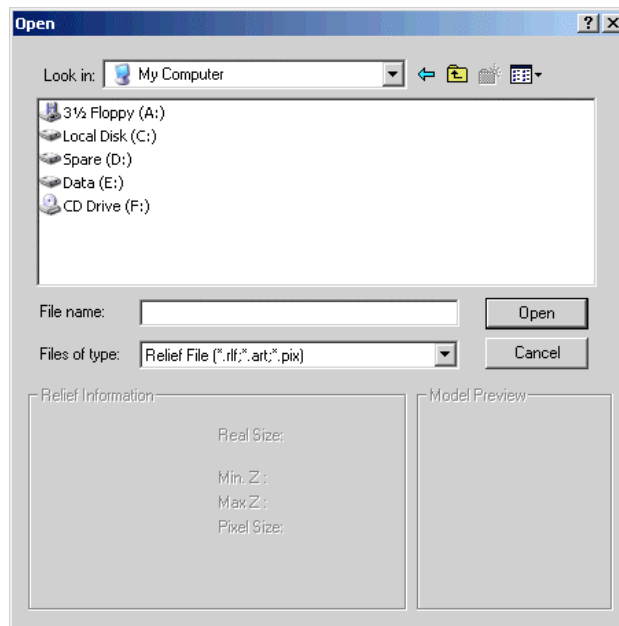

Next, click on the **Look in** list box and select the directory where the relief file is stored.

Now click to select the relief file that you want to load. The file name appears in the **File name** box. The relief dimensions appear in the **Relief Information** area of the **Open** dialog box.

Finally, click on the **Open** button to load the relief.

- **Create Offset Back Face** – To create a shape from an offset of the relief surface, click on this radio button . If you select this option, define the thickness of the offset in the **Thickness** box.
4. Click on the **Create Triangles** button to create the triangle mesh. The volume of the triangle mesh and the number of triangles created are shown in the **Result** area.

5. If you want to calculate the approximate weight of the ring component after the casting process, define a percentage in the **Shrinkage** box and then click on the **Update** button.
6. Click on the **Weight** list box, and from the list displayed click on the metal that you want to use for the cast of the ring component.
7. In the **Triangle Drawing** area, select how you want to view the triangle model in the **3D View** window, either **Shaded** or **Wireframe**.
8. You are now ready to save the triangle model. Click on the **Save Triangles** button to display the **Save Triangle Mesh** dialog box:

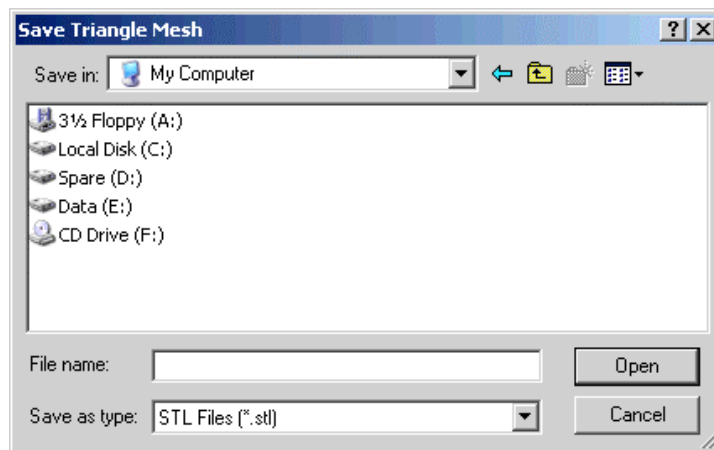

First, click on the **Save In** list box and select the directory in which you want to save the triangle mesh.

Next, click on the **Save as type** list box, and then on the file type you want to save the triangle mesh as (\*.stl, \*.dmt or \*.3da).

Finally, type the file name you want to use for the triangle model in the **File name** box, and then click on the **Save** button.

9. Click on the **Close** button to return to the **Assistant's** Home page.

## Creating a Cross-Section

You can create a vector object representing the cross-section of a relief using only the mouse and the **Create Relief Cross-Section** page.

ArtCAM Pro calculates the measurement details in real time. This means that you can view the calculated values on the **Relief Cross-Section** page as you are dragging the cursor into position.

To create a cross-section:

1. Click on the **Create Cross-Section** button  in the **Relief Operations** area of the **Assistant's** Home page to display the **Create Relief Cross-Section** page.
2. Move the cursor over the area in the model (the white area) that in which you want to create a cross-section, and then click on the position that you want to define as the start.

The co-ordinates of the cross-section's start position appear in the **Anchor Position's X** and **Y** area.

By default, the + cursor snaps to points (nodes) in a vector object. This is indicated by the cursor changing to a cursor when over the points (nodes).



---

**Note:** To disable snapping, hold the **Shift** key down on your keyboard whilst dragging the cursor into position.

---

3. Drag the mouse over the position in the span that you want to define as the end of the cross-section, and then click.

The distance between the start and the end of the cross-section is shown in the **Distance** area.

The angle between the start and the end position of the cross-section is shown in the **Angle** area.

The distance between the start and the end of the cross-section in both the X and Y axes is shown in the **X and Y distance** area.

4. If you want to align the cross-section with the X-axis, click to select the **Align Cross Section Horizontally** option .
5. Click on the **Create** button to create the cross-section.
6. Click on the **Close** button to return to the **Assistant's** Home page.

## Creating an Angled Plane

You can create an angled plane using up to three defined points in a model.

To create an angled plane:

1. Click on the **Create Angled Plane** button  in the **Relief Editing** area of the **Assistant's** Home page to display the **Create Angled Plane** page in the **Assistant** window.



---

**Note:** You can also display the **Create Angled Plane** page from the Main menu bar. Click on the **Relief** menu, and then on the **Create Angled Plane...** option.

---

2. If you want to create an angled plane within the boundary of a vector object, click to select the vector object. For details, see "Selecting Vectors" in the Working with Vectors chapter. If you do not select a vector object, the angled plane is created across the entire relief surface.
3. If you want to create an angled plane using three defined points, click to select the **Set Third Point** option . The **Third Point on Plane** area appears on the page.

The advantage of selecting a third point is that it adds a tilt or 'roll' to the sides of the angled plane.

4. You can use the mouse cursor to define the points on the plane:
  - Click on the **Start** button in the **Use Cursor to Select Points** area, move the + cursor over the required position in the **2D View** window, and then click. The co-ordinates for this point are displayed in the **X**, **Y** and **Z** boxes.

The co-ordinates for this point appear in red when you click on the **Start** button, then change to black when you click in the **2D View** window.

Alternatively, type the co-ordinates of the point in the **X**, **Y** and **Z** boxes in the **First Point on Plane** area.

5. If you had defined the first point using the mouse cursor:
  - Move the cursor over the required position in the **2D View** window, and then click to define the second point. The co-ordinates for this point are displayed in the **X**, **Y** and **Z** boxes.

The co-ordinates for this point appear in red, then change to black when you click in the **2D View** window.

Otherwise, type the co-ordinates of the point in the **X**, **Y** and **Z** boxes in the **Second Point on Plane** area.

6. If you had defined the first and second points using the mouse cursor:
  - Move the cursor over the required position in the **2D View** window, and then click to define the third point. The co-ordinates for this point are displayed in the **X**, **Y** and **Z** boxes.

The co-ordinates for this point appear in red, then change to black when you click in the **2D View** window.



Alternatively, type the co-ordinates of the point in the **X**, **Y** and **Z** boxes in the **Third Point on Plane** area.

7. In the **Combine** area, click on one of the radio buttons  to select how the angled plane is combined with the existing relief:
  - To add the angled plane to the existing relief, click on the **Add** option. For more details, see "Adding to the Relief" on page 326.
  - To subtract the angled plane from the existing relief, click on the **Subtract** option. For more details, see "Subtracting from the Relief" on page 328.
  - To merge the angled plane with the existing relief, so that only the highest points of the two remain, click on the **Highest** option. For more details, see "Merging with the Relief" on page 330.
  - To merge the angled plane with the existing relief, so that only the lowest points of the two remain, click on the **Lowest** option. For more details, see "Merging with the Relief" on page 330.
8. Click on the **Create** button.
9. Click on the **Close** button to return to the **Assistant's** Home page.

## Blending 3D Shapes

You can create new types of three-dimensional shapes called 'blended' shapes. A blended shape is a three-dimensional shape that can be generated from vector objects or the existing relief.

To create a blended shape:

1. Select the vector object to define the outline of the blended shape. For details, see "Selecting Vectors" in the Working with Vectors chapter.
2. Click on the **Create 3D Blend** button  in the **Relief Editing** area of the **Assistant's** Home page to display the **Create 3D Blend** page.
3. In the **Profile** area, select the profile of the blended shape by clicking on the appropriate radio button 
  - **Linear** – This option instructs ArtCAM Pro to create a straight-edged shape.
  - **Convex** – This option instructs ArtCAM Pro to create a shape that curves outwards.
  - **Concave** – This option instructs ArtCAM Pro to create a shape that curves inwards.
  - **Smooth** – This option instructs ArtCAM Pro to create a shape with rounded edges.
  - **Selected Vector** – This option allows you to use a cross-section to define the profile of the shape.  
If you have selected this option, hold the **Shift** key down on your keyboard, and then click on the open vector object that you want to use as the cross-section. Both the selected vector objects turn magenta and are surrounded by a bounding box.
4. In the **Heights** area, define the height of the blended shape:
  - To define the height at the centre of the blended shape, type its value in the **Inner** box.
  - If you want to set the height at the centre of the blended shape as equal to the highest point in the existing relief, click to select the **From Relief** option .



- To define the height at the edge of the blended shape, type its value in the **Border** box.
- If you want to set the height at the edge of the blended shape as equal to the lowest point in the existing relief, click to select the **From Relief** option .

For example, a blended shape with a concave profile, a centre height of 15 mm and a border height of 5 mm is shown below:

*Selected Vector Object...*

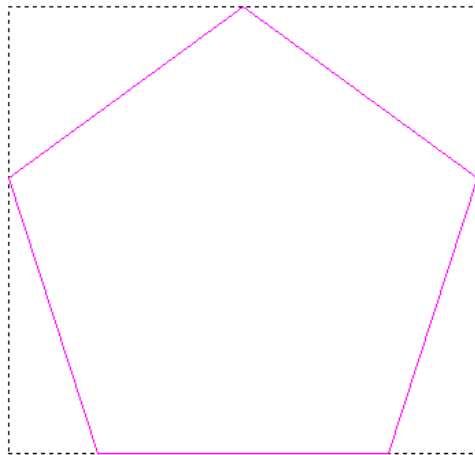

*Blended Shape...*

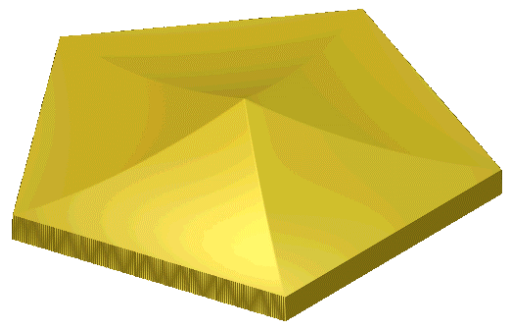

In this example, the default centre option and proportion value is used. This means that the centre of gravity in the polygon defines the centre of the blended shape and the concave profile extends across its entire surface.

Alternatively, the same blended shape could be produced from a polygonal relief with a Z height of 15 mm. In this instance, the centre height is taken from the relief and the border height is defined as 5 mm:

5. In the **Blend From Border To** area, click on one of the options to define the centre of the blended shape:
  - **Middle of Border Vector** – This option instructs ArtCAM Pro to use the centre of gravity in the vector object selected first as the centre of the blended shape.

In our example, a circle within the polygon is used to define the centre height of the blended shape:

*Selected Vector Objects...*

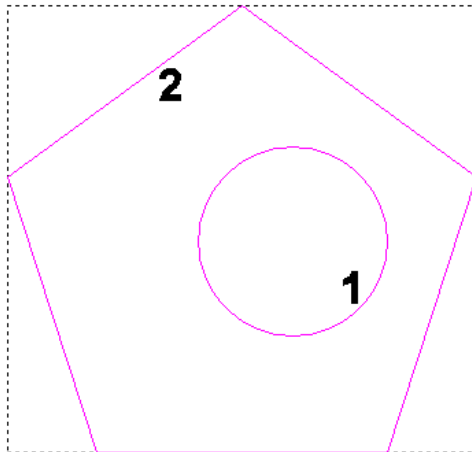

*Blended Shape...*

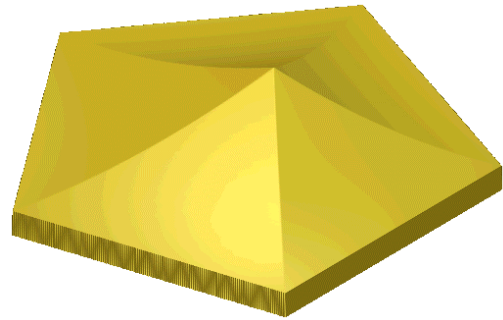

- **Select Point with Cursor** – This option allows you to define the centre of the blended shape in either of the following ways:

Click on the **Start** button, and then on the centre position in the **2D View** window. The X and Y co-ordinates of the centre appear in the **X** and **Y** boxes; or

Type the X and Y co-ordinates of the centre position in the **X** and **Y** boxes.

- **Inner Vector Edge** – This option instructs ArtCAM Pro to use the outline of another vector object drawn within the first as the centre of the blended shape.

If you have selected this option, make sure that the second vector object is positioned correctly within the first. Hold the **Shift** key down, and then click to select the vector object. The two vector objects turn magenta.

If you want to create a planar cap in the shape of the second vector object at the height specified for the centre of the blended shape, make sure that the **Fill Centre** option is selected .



---

**Note:** If you have selected a **From Relief** option to define the blended shape's centre or border height, this option is greyed-out.

---

In our example, the edge of the circle is used to define the centre of the blended shape. You can see how filling the centre affects its overall shape:

*Fill Centre Option OFF...*

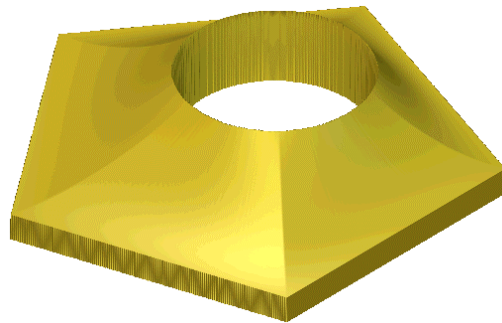

*Fill Centre Option ON...*

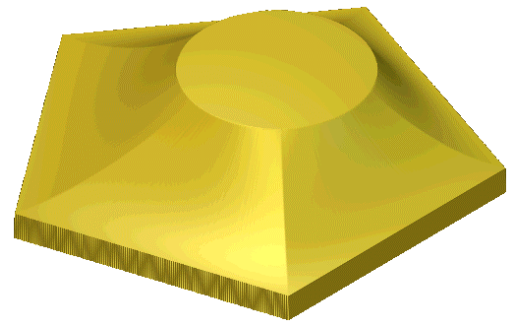

6. If you want to control the area over which the profile is extended across the surface of the blended shape, you can use either of these methods:
- In the **Proportion** box, define the percentage of the area from the outside-edge of the blended shape to its centre across which you want to extend the profile.
  - Click and drag on the slider to set the area from the outside-edge to the centre of the blended shape across which you want to extend the profile.

Any value less than 100% produces a blended shape with a planar cap at the height previously specified for its centre.

In our example, if the proportion is adjusted to 75% the blended shape now appears as shown:

*Selected Vector Object...*

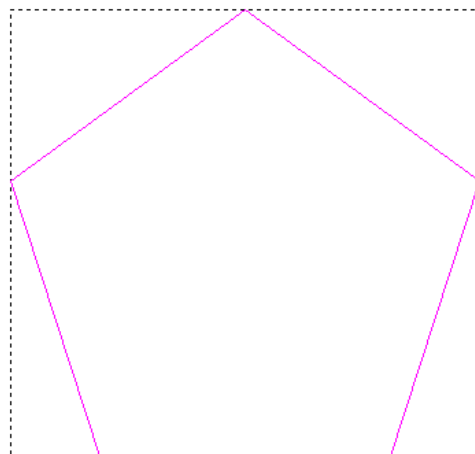

*Blended Shape...*

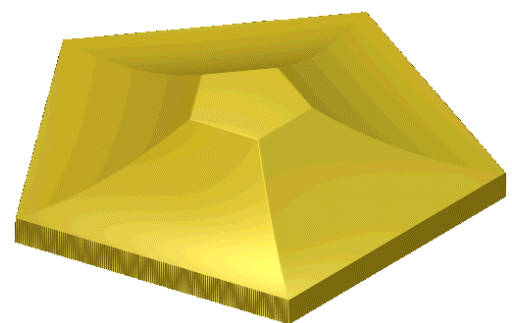

You can see that the concave profile does not extend across the entire surface of the blended shape, and a polygonal shaped planar cap is formed over its centre.

7. In the **Combine** area, select how you want to combine the blended shape with the existing relief:



---

**Note:** If you have selected a **From Relief** option to define the blended shape's centre or border height, go straight to the next step.

---

- Click on the **Add** radio button  to add the blended shape to the points in the existing relief. For more details, see "Adding to the Relief" on page 326.
  - Click on the **Subtract** radio button  to subtract the blended shape from the existing relief. For more details, see "Subtracting from the Relief" on page 328.
  - Click on the **Highest** radio button  to merge the blended shape with the existing relief, so that only the highest points of the two remain. For more details, see "Merging with the Relief" on page 330.
  - Click on the **Lowest** radio button  to merge the blended shape with the existing relief, so that only the lowest points of the two remain. For more details, see "Merging with the Relief" on page 330.
8. Click on the **Create Blend** button to create the blended shape. A progress bar appears beneath the **2D View** window indicating the progress ArtCAM Pro is making in calculating the blended shape.
  9. Click on the **Close** button to return to the **Assistant's** Home page.

## Relief Envelope Distortion

You can distort an area of a relief within the boundary of a selected vector object drawn within a model. When working in relief envelope distortion mode, ArtCAM Pro converts the four sides of the bounding box that surrounds a selected vector object into bezier spans. Moving the nodes and control points that make up the distortion envelope around the selected vector object allows you to manipulate the original shape of the relief, which in turn allows you to add perspective to the relief. You can also move, resize, rotate or shear the distortion envelope, which allows you to restructure the relief easily.

To distort an area of the a relief within the boundary of a selected vector object:

1. Select the vector object that marks the area of the relief that you want to distort. For details, see "Selecting Vectors" in the Working with Vectors chapter.

In the following example, we can see a greyscale image of a church within a selected rectangular vector object:



2. Click on the **Relief Envelope Distortion** button  in the **Relief Editing** area to display the **Relief Envelope Distortion** page. The four sides of the bounding box surrounding the selected vector object change to bezier spans. The gridlines drawn within these spans indicate that you are now in relief envelope distortion mode.

The distortion envelope allows you to manipulate the area of the relief within the boundary of the selected vector object.

In our example, a distortion envelope now encloses the area of the relief within the selected rectangular vector object:

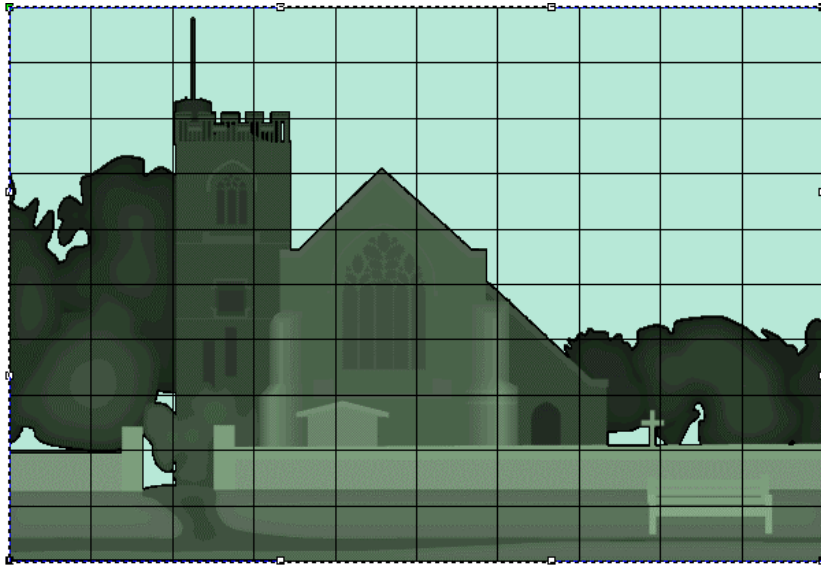



You can see how the church relief currently appears in the **3D View** window when seen viewed down the Z-axis:



3. In the **Original Relief** area, select how you want to use the area of the relief that you have chosen to distort:
  - If you want to keep a copy of the relief as it appears prior to distortion, click to select the **Keep original relief (Copy)** option.
  - If you do not want to keep a copy of the relief as it appears prior to distortion, click to select the **Replace original relief (Cut)** option.

In our example, we will replace the existing relief with the relief as it appears after it has been distorted.

4. In the **Editing Mode** area, select the mode you want to use to manipulate the distortion envelope:

- Click on the **Edit Distortion Envelope Nodes** button  if you want to adjust the shape of the distortion envelope. For details, see "Editing Vector Nodes" in the Working with Vectors chapter.
- Click on the **Transform Envelope** button  if you want to move, resize, rotate or shear the distortion envelope. For details, see "Transforming Vector Objects" in the Working with Vectors chapter.
- If you do not want to create a vector outline of the distorted relief, click to deselect the **Create vector outline** option .
- If you want to display a greyscale image of the relief in the **2D View**, click to select the **Display greyscale in 2D View** option .





---

**Note:** You can also click on the **Greyscale View** button  in the **2D View** toolbar to display a greyscale image of the relief. For details, see "Greyscale View" in the ArtCAM Pro Layout chapter.

---

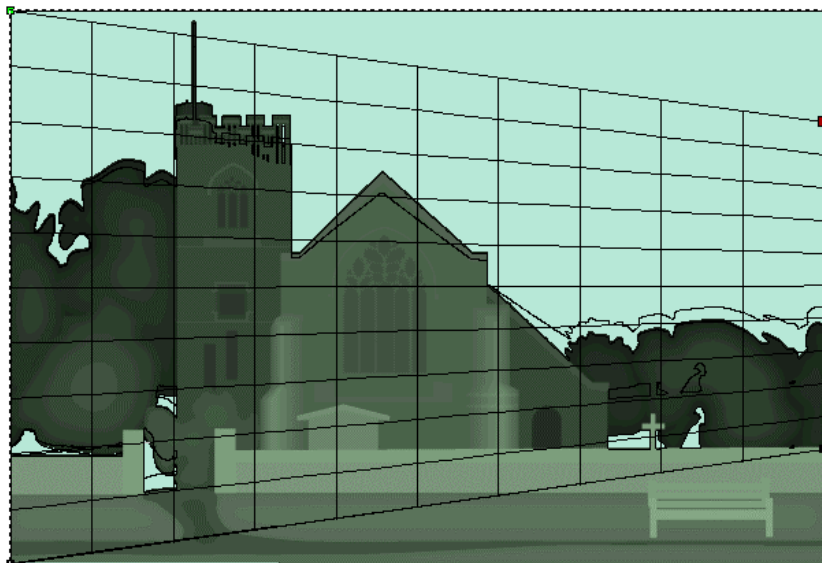
In our example, we work in **Edit Distortion Envelope Nodes** mode in order to convert the edges of the distortion envelope to linear spans and drag the points on the top-right and bottom-right corners toward one another:



5. Click on the **Relief Z Height Scaling** list box to display a list of options you can use to control how the Z height of the

distorted relief is scaled, then click to select the option that you want to use:

- **Average Scale** – This option applies an overall scaling factor to the distorted relief based on the change in its area.
- **Linear Scale** – This option calculates the Z height of each point within the relief based on the local distortion at that point. For example, if the area of the distorted relief has increased at a particular point then the height of that point will also increase.
- **Stretch & Squeeze** – This option calculates the Z height of each point within the relief based on the local distortion at that point. For example, if the area of the distorted relief has decreased (squeezed) then its Z height will be raised. If the area of the distorted relief has increased (stretched), then its Z height will be lowered.
- **Keep Current Z** – This option maintains the existing Z height of the distorted relief.

If you want to apply an additional scaling factor to the distorted relief, define the percentage by which you want to scale its Z height in the **Scaling Factor** box.

6. If you want to use either one or two curved vector objects selected from the **2D View** window to control the dimensions and position of a new distortion envelope which can be used to manipulate copies of the distorted relief, click to select the **Use existing curve(s)** option  to display its settings.

If you want to use a single curved vector object:

- First, click to select the **Wrap along single curve** radio button . The **Wrap between 2 curves** settings are greyed-out.
- Next, click to select the curved vector object that you want to use from the **2D View** window, and then click on the **Select Curve...** button. For details, see "Selecting Vectors" in the Working with Vectors chapter.



An arrow appears on the selected vector object indicating the direction in which the distorted relief will be pasted along it. The Start Point is shown in green.

For example, you might use a polyline something like that shown below:

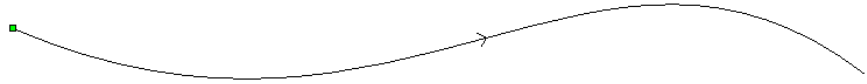

- Finally, click on the list box and then on the option that you want to use to control the position of the distortion envelope relative to the selected vector object:

**Left** – Click to select this option if you want to position the distortion envelope to the left of the selected vector object's Start Point, looking down the vector.

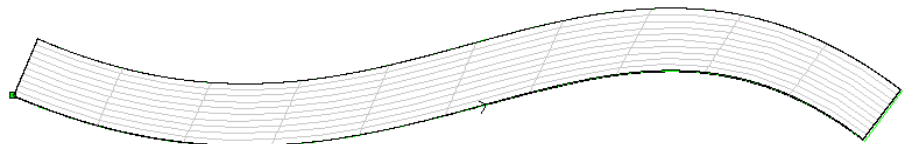

**Right** – Click to select this option if you want to position the distortion envelope to the right of the selected vector object's Start Point, looking down the vector.

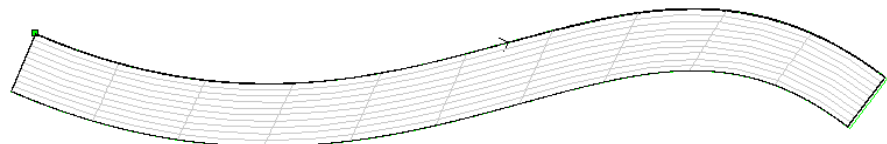

**Centred** – Click to select this option if you want to position the centre of the distortion envelope along the selected vector object.

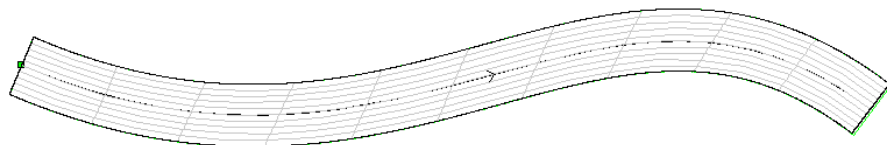

If you want to specify the width of the distortion envelope, click to select the **specify envelope width** option  and then define its width in the **Width** box. Its length is always equal to that of the selected vector object.

If you want to use two curved vector objects:



- First, click to select the **Wrap between 2 curves** radio button . The **Wrap along single curve** settings are greyed-out.

- Next, click to select the curved vector object shown in the **2D View** that you want to use as the top edge of the distortion envelope, and then click on the **Select Top Curve...** button.

An arrow appears on the selected vector object indicating the direction in which the distorted relief will be positioned along it. The Start Point is shown in green.

- Finally, click to select the curved vector object shown in the **2D View** that you want to use as the bottom edge of the distortion envelope, and then click on the **Select Bottom Curve...** button.

An arrow appears on the selected vector object indicating the direction in which the distorted relief will be positioned along it. The Start Point is shown in green.

7. In the **Number of Copies** area, define the number of copies of the distorted relief that you want to create:
  - If you want to stretch the distorted relief along the length of the selected vector object(s), click to select the **One - Stretch to Fit** radio button .
  - If you want ArtCAM Pro to calculate the optimum number of copies of the distorted relief that should be created along the selected vector object(s), click to select the **Many - Best Fit** radio button .
  - If you want to create a specific number of copies of the distorted relief along the selected vector object(s), click to select the **Many - Specific number of copies** radio button  and then define the number of copies in the **Copies** box.
8. Click on the **Apply** button to position the distortion envelope about the selected curved vector object(s). The distortion envelope is divided into sections equal to the number of copies of the distorted relief you want to create.
9. In the **Combine** area, click to select the relief combination method that you want to use:

- Click to select the **Add** option if you want to add the distorted relief to the current relief. For more details, see "Adding to the Relief" on page 326.
- Click to select the **Subtract** option if you want to subtract the distorted relief from the current relief. For more details, see "Subtracting from the Relief" on page 328.
- Click to select the **Highest** option if you want to merge the distorted relief with the current relief, so that only the highest points of the two show. For more details, see "Merging with the Relief" on page 330.
- Click to select the **Lowest** option if you want to merge the distorted relief with the current relief, so that only the lowest points of the two show. For more details, see "Merging with the Relief" on page 330.

In our example, we will add the distorted relief to the current relief.

10. Click on the **Paste** button to combine the distorted relief with the existing relief.

If you do not want to paste the relief, click on the **Cancel** button.

In the following image, you can see how perspective has now been added to the church relief when it is viewed down the Z-axis:

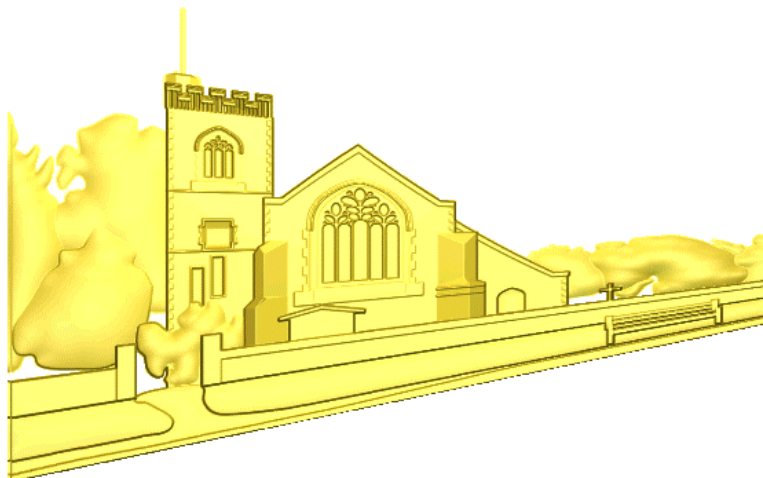

11. Click on the **Finish** button to return to the **Assistant's** Home page.

## Fading a Relief

You can fade and feather all or part of a relief, controlling the strength and direction of the fade that is applied.

*Before...*

*After...*

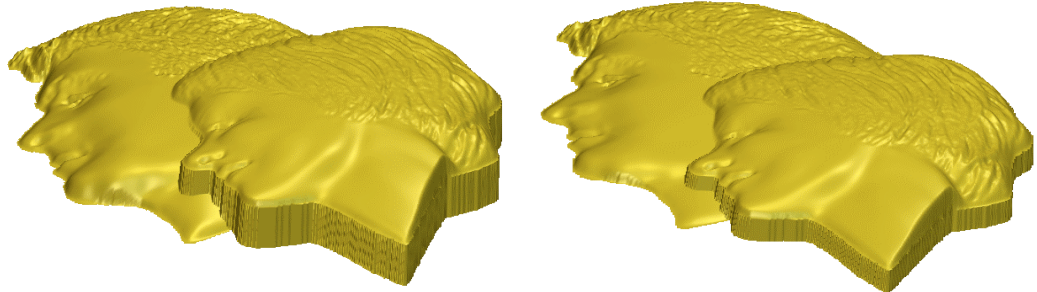

Coupled with the **Envelope Distortion** tool, the **Fade Relief** tool is particularly useful for adding perspective to your designs. It also allows you to graduate textures applied to the relief surface. Perhaps most importantly, the ability to fade a relief assists in assuring that you remain within the constraints of a block of material when combining reliefs.

To fade an area of the relief currently shown in the **3D View** window:

1. Click on the **Fade Relief** button  in the **Relief Editing** area of the **Assistant's** Home Page to display the **Fade Relief** page.
2. If you only want to fade a specific area of the relief, make sure that you draw and then select the vector that identifies the boundary of the fade. If you do not, the fade will be applied to the entire relief.
3. In the **Fade Strength** area, set the strength of the fade effect that you want to apply to the relief using either of the following methods:
  - Click and drag the slider to the right to increase the strength of the fade, or click and drag to the left to reduce the strength of the fade or feather.
  - Type the percentage in the box.

Using a strength of 100% will fade the relief to zero, whilst a strength of 0% will not fade the relief at all.

4. If you want to fade the relief in the opposite direction, click to select the **Reverse** option . This option is deselected by default.
5. In the **Fade Type** area, click to select the method you want to use when fading the relief:

- **Linear** – this allows you to create a straight-edged sloped shape between two defined points. The first point identifies the original height of the relief, whilst the height at the second point depends on your **Fade Strength** setting.

For example, take a row of six rectangular shapes each with a height of 25 mm. If you create a linear fade horizontally across the relief surface applying a strength of 50%, the resulting height at the first point is 25 mm whilst the height at the second point is 12.5 mm.

*Before...*

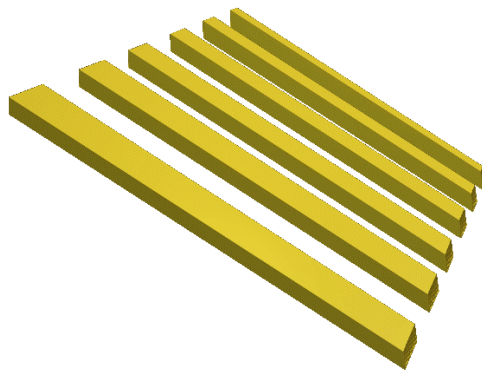

*After Linear Fade...*

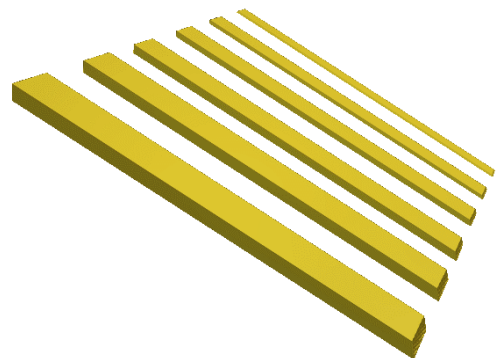

- **Radial** – this allows you to create a convex or concave shape, depending on whether you have selected the **Reverse** option or not, using a defined centre-point.

If you select this method, you must click to select a vector drawn in the **2D View** to define the area of the relief in which you want to apply the fade.

For example, applying a radial fade with a strength of 100% to a textured relief within a selected circular vector produces the following results:

*Greyscale of Textured Relief...*

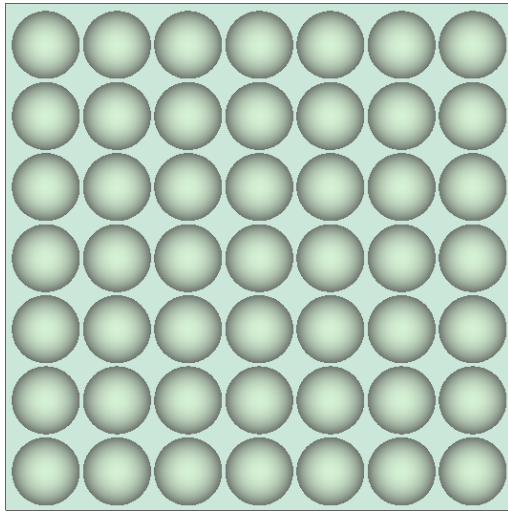

*Selected Radial Vector...*

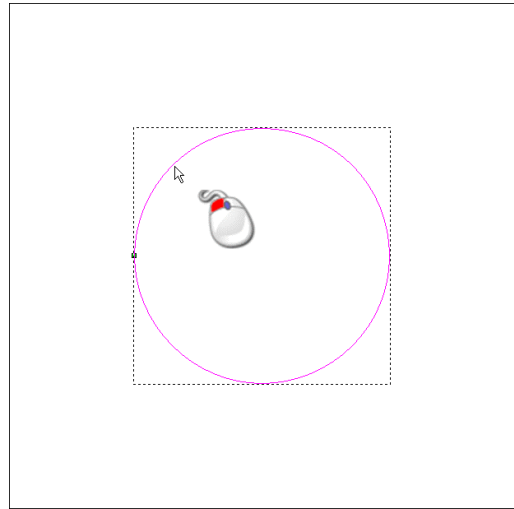

*Radial Fade...*

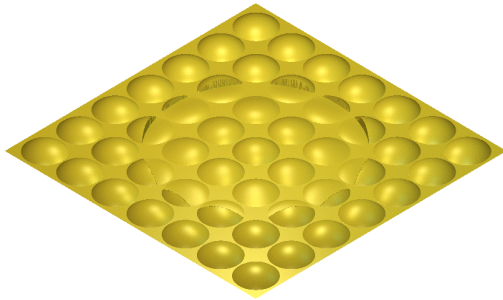

*Radial Fade Reversed...*

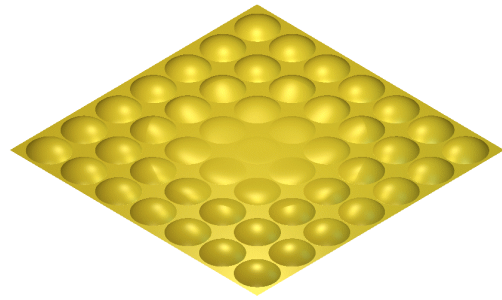

- **Between Boundaries** – this allows you to create a convex or concave shape between two closed vectors, depending on whether you have selected the **Reverse** option or not.

If you select this method, you must click to select two vectors drawn in the **2D View** to define the area of the relief between which you want to apply the fade.

For example, applying a fade with a strength of 100% to a textured relief between a selected circular vector and a rectangular vector produces the following results:

*Greyscale of Textured Relief...*

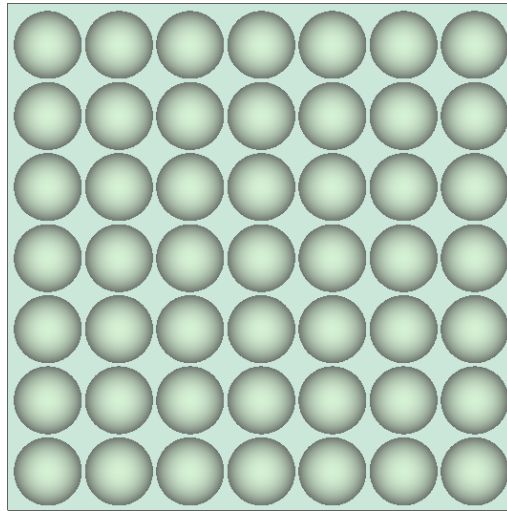

*Selected Vector Boundaries...*

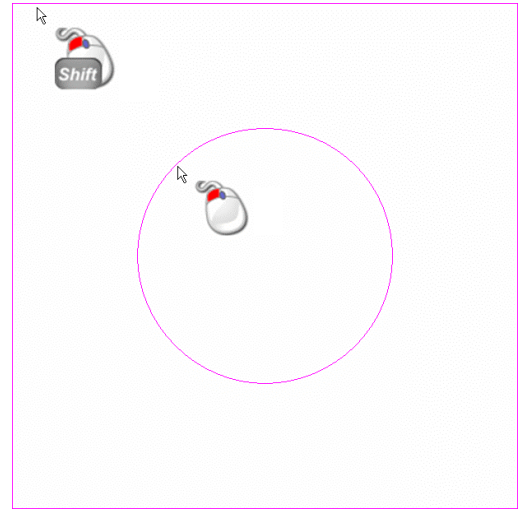

*Fade Between Boundaries...*

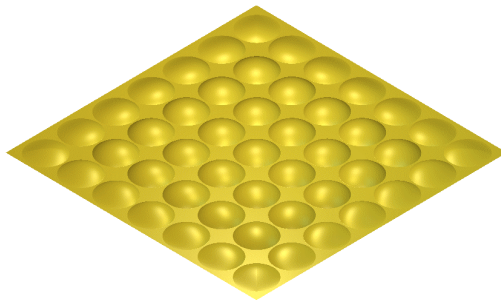

*Fade Between Boundaries Reversed...*

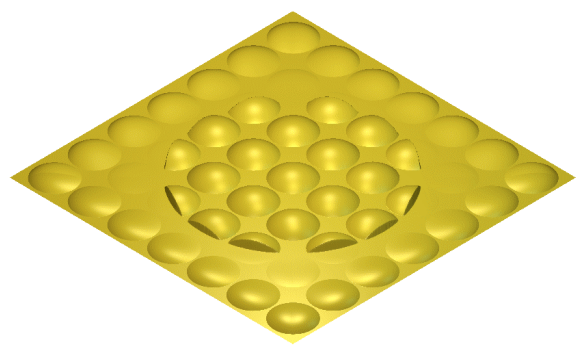

6. In the **Options** area, define the point(s) in the model area that you want to use to control the position and direction of the fade.

Use the following method when creating a linear fade:

- First, click on the **Start** button.
- Next, move the cursor over the location in the model area that you want to define as the start point, and then click. The co-ordinates of the point are displayed in the **Fade From** area.
- Finally, move the cursor over the location in the model area that you want to define as the end point, and then click. The co-ordinates of the point are displayed in the **Fade To** area.

Use the following method when creating a radial fade:

- First, click on the **Select Centre** button.

- Next, move the cursor over the location in the model area that you want to define as the centre point, and then click. Typically, this will be inside of the selected vector used to define the radial fade area. The co-ordinates of the point are displayed in the **X** and **Y** area.
7. Click on the **Create** button to fade the relief according to the settings on the page.
  8. Click on the **Close** button to return to the **Assistant's** Home page.

## Creating a Ring

You can display a relief as it would appear when machined as a ring on a rotary axis CNC machining tool.

To create a ring:

1. From the Main menu bar, click on the **Relief** menu, and then on the **Create Ring** option to display the **Create Ring** dialog box:



2. Select the axis around which you want to wrap the relief:
  - Click on the **Wrap X** radio button  if you want to wrap the relief around the X-axis.
  - Click on the **Wrap Y** radio button  if you want to wrap the relief around the Y-axis.
3. Click on the **OK** button to close the **Create Ring** dialog box and create the ring.

## Adding Texture to a Relief

You can apply texture to a relief in two different ways:



- Apply a basic pattern created in ArtCAM Pro.
- Import a relief.

Texture can either be applied to the whole relief, to those areas of the relief under the current Primary Colour or as defined by a selected vector object.

Both of these methods of applying texture to a relief work in the same way. The pattern is selected or the relief file is imported, the size of the pattern is defined, then the repeat distance in X and Y is defined along with the pattern overlap (O). Finally, the texture is tiled onto the relief by either adding or subtracting from its surface.

To add texture to the relief:

1. Click on the **Texture Relief** button  in the **Relief Editing** area of the **Assistant's** Home page to display the **Texture Relief** dialog box:

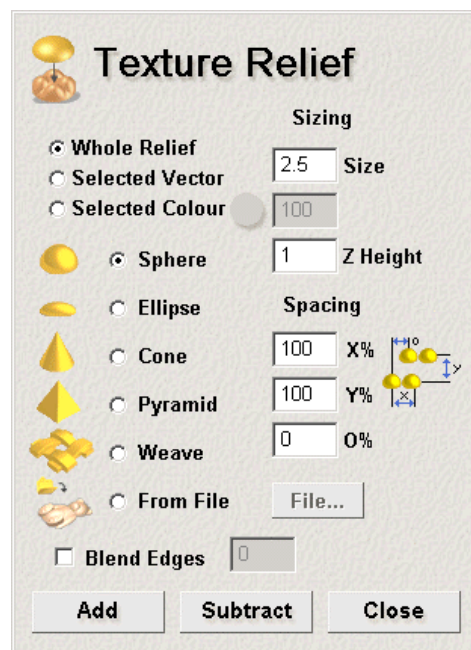

2. Define the area of the relief to which you want to apply a texture. By default, the **Whole Relief** option is selected. This means that the texture covers the entire relief surface. Alternatively, you can either use a vector object or bitmap colour to define the area(s) of the relief to which you want to apply a texture. If you want to use a vector object:
  - Click to select the vector object from the **2D View** window, and then on the **Selected Vector** radio button . For details, see "Selecting Vectors" in the Working with Vectors chapter.

If you want to use a bitmap colour:

- Select the Primary Colour from the Colour Palette beneath the **2D View** window, and then click on the **Selected Colour** radio button . For details, see "Selecting the Primary and Secondary Colours" in the Working with Bitmaps chapter.
3. Click on the appropriate radio button  to select the texture you want to combine with the existing relief, and then define its size and height.

The size of the texture determines how it is applied to the relief. If the texture's current size does not match that of the area of the relief to which it is being applied, you can either compress or expand it so that it fits perfectly over the area, or allow ArtCAM Pro to automatically tile it over the area.

- If you have selected the **Sphere** option , define its size and height in the **Size** and **Z Height** boxes in the **Sizing** area of the **Texture Relief** dialog box.
- If you have selected the **Ellipse** option , define its size, scaling factor and height in the **Size**, **Horizontal %** and **Z Height** boxes in the **Sizing** area of the **Texture Relief** dialog box.
- If you have selected the **Cone** option , define its size, scaling factor and height in the **Size**, **Tip Radius %** and **Z Height** boxes in the **Sizing** area of the **Texture Relief** dialog box.
- If you have selected the **Pyramid** option , define its size, scaling factor and height in the **Size**, **Truncation %** and **Z Height** boxes in the **Sizing** area of the **Texture Relief** dialog box.
- If you have selected the **Weave** option , define its size, scaling factor and height in the **Size**, **Bar Width %** and **Z Height** boxes in the **Sizing** area of the **Texture Relief** dialog box.
- If you have selected the **From Relief** option , click on the **File** button to display the **Open** dialog box:

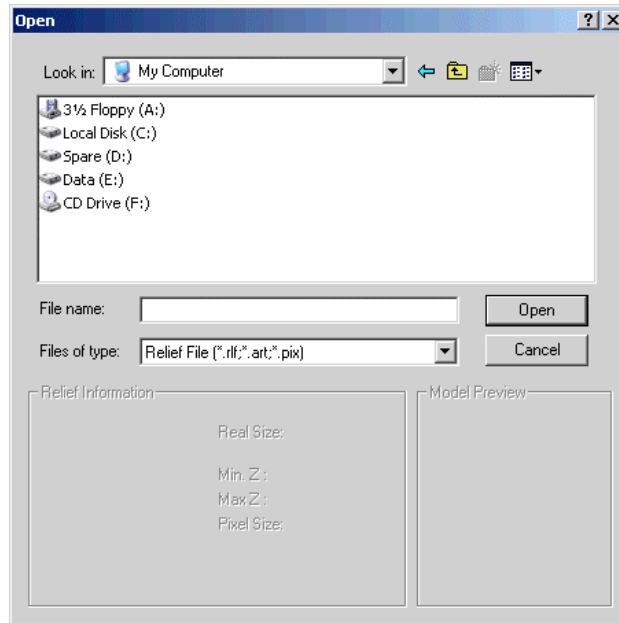

Click on the **Look in** box and select the directory where the relief file that you want to use is stored, and then click on the relief file itself. Click on the **Open** button to load the selected relief file. The relief dimensions appear in the **Sizing** and **Spacing** areas of the **Texture Relief** dialog box.

4. In the **Spacing** area, define the repeat distance along the X-axis in the **X%** box.
5. Define the repeat distance along the Y-axis in the **Y%** box.
6. Define the overlap distance in the **O%** box.
7. If you want to blend the edges of the selected texture into the relief surface, click to select the **Blend Edges** option .
8. Select how you want to combine the texture with the existing relief:
  - To add the texture to the existing relief, click on the **Add** option. For more details, see "Adding to the Relief" on page 326.
  - To subtract the texture from the existing relief, click on the **Subtract** option. For more details, see "Subtracting from the Relief" on page 328.
9. Click on the **Close** button to close the **Texture Relief** dialog box.

## Adding Texture Example

In the following example, you can see how the **Texture Relief** dialog box is used to add texture to an imported relief to create a new, textured relief.

1. From the Main menu bar, click on the **Relief** menu, and then on the **Load > Replace** option. The **Open** dialog box appears:

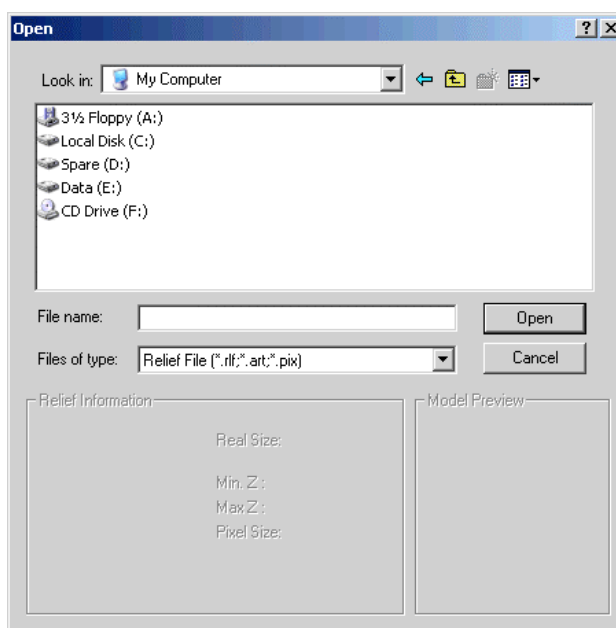

2. Click on the **Fin\_pend.rlf** file in ArtCAM Pro 8.0\Examples\Overview to select it, then click on the **Open** button to import the relief.

If the loaded relief is larger or smaller than the existing relief, the following message box appears:

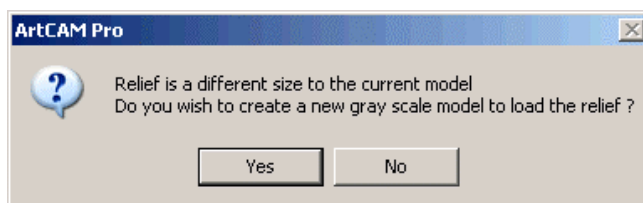



Click on the **Yes** button. The new model is created, and a greyscale image of the loaded relief is shown in the **2D View** window.

3. Click on the **2D View** window to select it. A greyscale image of the imported relief appears in the model as follows:

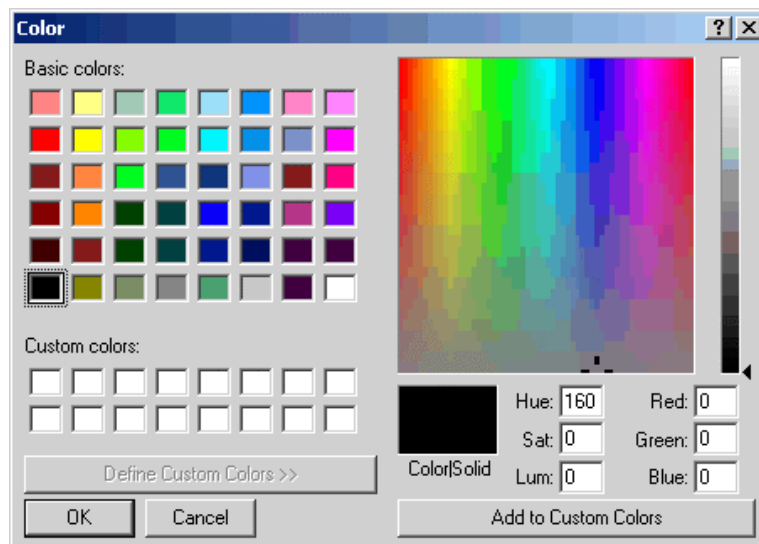

4. Click on the **Add Colour** button  in the **Bitmap Editing** area to display the **Color** dialog box:





5. Click on the red colour in the **Basic Colors** area to select it as the Primary Colour, then click on the **OK** button to close the **Color** dialog box.
6. Click on the **Flood Fill** button  in the **Bitmap** toolbar, then click on the area surrounding the lady's head in the **2D View** window to flood fill it in red. The greyscale image of the imported relief appears in the model as follows:

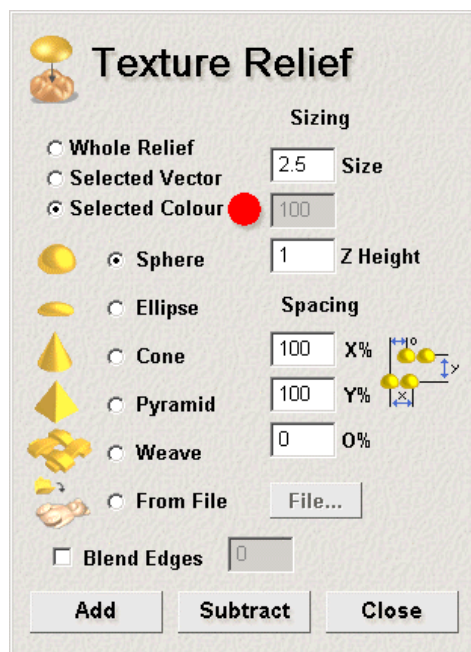

- Click on the **Texture Relief** button  in the **Relief Editing** area to display the **Texture Relief** dialog box:



- Click to select the **Selected Colour** radio button .
- Click to select the **Pyramid** radio button .
- Type *0.5* in the **Size** box.
- Type *50* in the **Truncation %** box.
- Type *0.1* in the **Z Height** box.
- Click on the **Add** button to apply the texture to the area of the relief that is flood filled in red.

14. Click on the **Close** button to close the **Texture Relief** dialog box.
15. Click on the **3D View** button  in the **2D View** toolbar to display the **3D View** window. The new relief should appear something like the image shown below:



## Sculpting a Relief

You can edit the shape of the existing relief using the sculpting tools available in ArtCAM Pro.

To sculpt a relief:

1. Click on the **Sculpting** button  in the **Relief Editing** area of the **Assistant's** Home page to display the **Interactive Sculpting** page in the **Assistant** window:

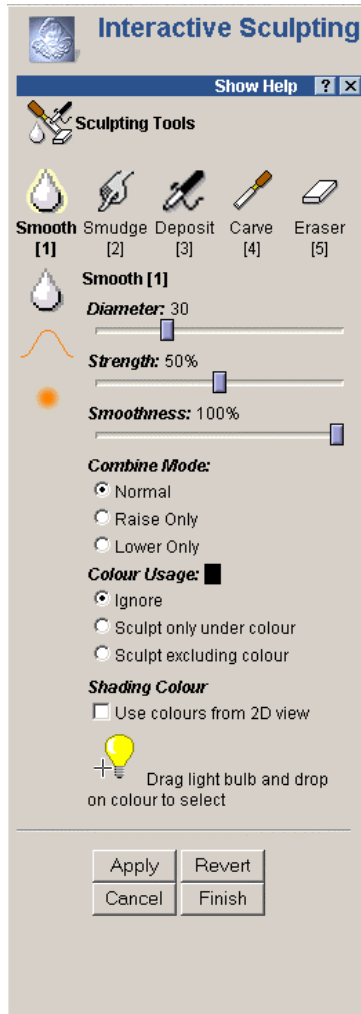

2. In the **Sculpting Tools** area, click to select which of the five tools you want to use:



- **Smooth** If you want to smooth an area of the relief by blending one area with the next, click on the **Smooth** tool. This tool is selected by default.



---

**Note:** You can also press the **1** key on your keyboard to select the **Smooth** tool.

---



- **Smudge** If you want to drag on an area of the relief to extend or reduce it, click on the **Smudge** tool.



---

**Note:** You can also press the **2** key on your keyboard to select the **Smudge** tool.

---





- **Deposit** If you want to add material to the relief, click on the **Deposit** tool.



---

**Note:** You can also press the **3** key on your keyboard to select the **Deposit** tool.

---



- **Carve** If you want to remove material from the relief, click on the **Carve** tool.



---

**Note:** You can also press the **4** key on your keyboard to select the **Carve** tool.

---



- **Eraser** If you want to remove the changes that you have made to the relief in the current sculpting session, click on the **Eraser** tool.



---

**Note:** You can also press the **5** key on your keyboard to select the **Eraser** tool.

---

3. To change the number of pixels that make up the width of the tool, click and drag on the **Diameter** slider.

The diameter of the tool controls how much material is deposited or removed from the area of the relief affected by the selected sculpting tool.

Click and drag to the right to increase the width of the tool. Click and drag to the left to reduce the width of the tool. The image to the left of the slider changes as you move the slider to reflect the diameter of the tool.

4. To change the height of the deposit or the depth of the removal as a percentage of the tool width, click and drag on the **Strength** slider.

Click and drag to the right to increase the height of the deposit or depth of the removal. Click and drag to the left to reduce the height of the deposit or depth of the removal. The image to the left of the slider changes as you move the slider to reflect the height of the deposit or the depth of the removal.



---

**Tip:** If your mouse has a wheel, you can roll it backwards to reduce the strength, or forwards to increase the strength of the selected tool.

---



5. To change the sharpness of the tool tip, click and drag on the **Smoothness** slider.
6. If you want to sculpt the relief using a bitmap colour projected onto its surface:
  - First, click to select the **Use colours from 2D view** option  in the **Shading Colour** area. The bitmap image or bitmap colours in the **2D View** window are projected onto the relief shown in the **3D View** window.





---



**Warning:** You might want to click to deselect the **Use Colours From 2D View** option  in the **Shading Colour** area when sculpting a face relief. If a photographic image is projected onto the relief during a sculpting session, your results can often be deceptive. For further details, see "Using the Face Wizard" in the Working with Models chapter.

---



- Next, click and drag the  icon over the colour that you want to select. The colour is displayed in the **Colour Usage** area
  - Finally, click on the appropriate **Colour Usage** radio button :
    - Ignore** – Click on this option if you do not want to sculpt underneath or around the selected colour.
    - Sculpt only under colour** – Click on this option if you only want to sculpt underneath the selected colour.
    - Sculpt excluding colour** – Click on this option if you only want to sculpt around the selected colour.
7. If you have selected the **Smooth** or **Smudge** tool, click to select a combination method  from the **Relief Combine Mode** or **Combine Mode** area to use when sculpting the relief:
    - To use the average smoothing result to raise and lower the region under the tool cursor , select the **Normal** option.

- To raise the lowest points under the tool cursor  only, select the **Raise Only** option.
- To lower the highest points under the tool cursor  only, select the **Lower Only** option.

If you have selected the **Deposit** tool, click on the appropriate **Relief Combine Mode** radio button :

- To deposit material onto the area of the relief under the tool cursor , select the **Add** option.
- To deposit a single layer of material onto the area of the relief under the tool cursor , regardless of how many times it passes over it, select the **Merge** option.

If you have selected the **Carve** tool, click on the appropriate **Relief Combine Mode** radio button :

- To carve material out of the area of the relief under the tool cursor , select the **Add** option.
- To carve a single layer of material out of the area of the relief under the tool cursor , irrespective of how many times it passes over it, select the **Merge** option.

8. Click and drag the tool cursor  in the **3D View** window to sculpt the relief according to the options you have selected on the **Interactive Sculpting** page.
9. Click on the **Apply** button to confirm the changes that you have made to the relief.

If you want to undo the changes that you have made and return the relief to its original state, or as it was when the **Apply** button was last clicked in this Interactive Sculpting session, click on the **Revert** button.

If you do not want to keep any of the changes you have made in this Interactive Sculpting session, click on the **Cancel** button.

10. Click on the **Finish** button to close the **Interactive Sculpting** page and return to the **Assistant's** Home page.

## Removing Holes in the Relief Surface

You can remove any small holes that can be seen on the relief surface.

To remove any small holes on the relief surface:

1. From the Main menu bar, click on the **Relief** menu, and then on the **Remove Small Holes** option.
2. Click on the **3D View** button  in the **2D View** toolbar to display the **3D View** window. Check the relief surface for any small holes that might still be present, and if necessary repeat these steps.



## Creating a Greyscale Image from a Relief

A greyscale is an image in which the only colours are shades of grey. You can create a greyscale image from the existing relief. For details, see "Creating a Greyscale Image from a Relief" in the Working with Models chapter and "Greyscale View" in the ArtCAM Pro Layout chapter.

## Rotating a Relief or Triangle Mesh

You can rotate the relief or triangle model shown in the **3D View** window. This allows you to improve the visualisation of the relief or triangle model, especially when a reflection map has been projected onto its surface. For details, see "Adjusting Light and Material Settings" in the Working with Models chapter.

To rotate a relief or triangle model:

1. Click on the **3D View** button  to display the **3D View** window.
2. Hold the **Ctrl** key down on your keyboard, move the  cursor over the relief or triangle model, and then push the mouse in the direction in which you want to rotate.

To stop the relief or triangle model revolving, click anywhere in the **3D View** window.

You can adjust the speed at which the relief or triangle model revolves using the **ArtCAM Options** page. For details, see "Managing ArtCAM Pro's Preferences" in the ArtCAM Pro Layout chapter.

# Machining Models

---

## Overview



---

**Warning:** It is assumed that you already know how to operate your machine tool, and that you are able to select the appropriate tools and the necessary cutting conditions for the job you are doing. If you are not confident about any aspect of operating your machine tool, consult a member of staff or your machine tool supplier.

---

You use toolpaths to machine both two-dimensional and three-dimensional models. 2D toolpaths are used to machine all or part of a model from the vector objects you have created. 3D toolpaths are used to machine all or part of a model from the three-dimensional shapes you have combined to make the relief.

ArtCAM Pro provides a database containing a broad selection of tools that you can use when creating your toolpaths. You can edit the machining parameters of these tools and add new tools to the database if necessary.

You can control the cut direction of the tools used for machining by selecting either Conventional or Climb Milling in almost all of the toolpath strategies available in ArtCAM Pro.

In Conventional Milling, the teeth of the tool meet the block of material at the bottom of the cut. The teeth of the tool slide along until sufficient pressure builds up to break through the material surface. This sliding action, under pressure, tends to abrade the edge of the tool, which results in dulling. Also, the cutting action has a tendency to lift the block of material, fixture and table from their positions.

### *Climb Milling...*

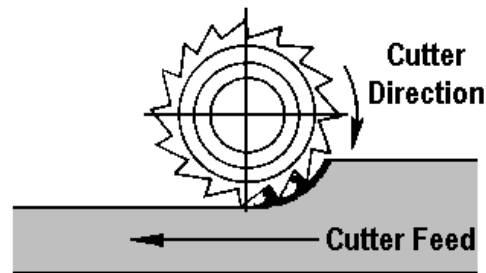

### *Conventional Milling...*

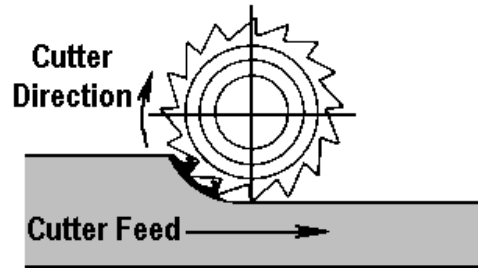

In Climb Milling, the teeth of the tool meet the block of material at the top of the cut, at the thickest part of the chip. This provides instant engagement of the tool with the block, providing a chip of definite thickness at the start of the cut. Climb Milling does not cause the abrasive action caused by Conventional Milling. It also permits the gradual removal of the tool from the block, so that dwell marks are largely eliminated. Climb Milling often provides a better finish, permits greater tool feed rates and prolongs the life of a tool.

You can control how the tool enters the block of material by adding ramping moves, also known as zigzag plunge moves, to almost all of the toolpath strategies available in ArtCAM Pro.

Feeding the cutter into the material surface in a straight plunge motion at full feed rate often causes pivoting around the tool in the direction of rotation. This, in turn, causes deflection. It is this deflection that causes gouging and, consequently, tool damage. Adding ramping moves, also known as zigzag plunge moves, allows the cutting tool to enter the block of material gradually, ensuring minimum tool damage and reducing the likelihood of gouging.

ArtCAM Pro allows you to create multiple toolpath strategies, each of them relating to a selected area of your model. This allows a number of roughing passes to be made, removing excess material prior to the finishing passes.

You can calculate a toolpath strategy individually or as part of a batch. Calculating toolpath strategies in a batch allows you to automatically process a collection of different toolpaths at once. This gives you the freedom to work continuously on creating a model, and calculate its corresponding toolpaths outside of working hours.

You can simulate any toolpath after it has been calculated. This allows you to visualise the surface finish and the machining passes that are used to machine all or part of your model.

You can save a toolpath strategy as a template. This allows you to apply the same toolpath settings to different parts of a model without

having to create a toolpath strategy over and over again. A template can be applied to a vector object or relief in a model.

In order to machine the model that you have created, you must create a toolpath file from the toolpaths you have calculated. A toolpath file contains one or more calculated toolpaths. Each toolpath is made up of a sequence of commands which tell a CNC machine tool or laser engraving system the path it is required to follow in order to produce your model.

You can save the toolpath file in a format recognised by your machine tool or engraving system. This ensures that the commands within the toolpath file are interpreted accurately by your system.

If your CNC machine has a tool changer, you can group all of the toolpath strategies for a series of tools into one machine-specific file.

If your CNC machine does not have a tool changer, you must generate separate toolpath files for each tool that you want to use.

## Using Toolpaths

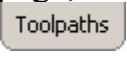
ArtCAM Pro provides a number of toolpaths that you can use to machine all or part of a two-dimensional or three-dimensional model. These are available using the **Toolpaths** Home page, which is displayed when you click on the **Toolpaths** tab .

For details of the 2D toolpaths that are available in ArtCAM Pro, see "2D Toolpaths" on page 405.

For details of the 3D toolpaths that are available in ArtCAM Pro, see "3D Toolpaths" on page 481.

You can also find buttons on the **Toolpaths** Home page that assist you in managing and modifying the toolpaths you have created. For details, see "Managing and Modifying Toolpaths" on page 508.

---

## 2D Toolpaths

ArtCAM Pro provides a number of two-dimensional toolpaths that you can use to machine your model, based on the vector objects created within it. These include:

- **2D Profiling.** This toolpath allows you to create a toolpath either inside or outside the boundary of a vector object. For details, see "2D Profiling" on page 407.

- **2D Area Clearance.** This toolpath allows you to clear an area of material either inside or outside the boundary of a vector object. You can use a range of tools with this strategy and ArtCAM Pro automatically calculates the order in which they should be used. For details, see "2D Area Clearance" on page 417.
- **V-Bit Carving.** This toolpath allows you to replicate a hand carved look for the vector object or vector text you want to machine. For details, see "V-Bit Carving" on page 423.



---

**Warning:** You cannot machine a V-Bit Carving toolpath without using a 3-axis machine. For further information, consult a member of staff or your machine tool supplier.

---

- **Bevel Carving.** This toolpath allows you to replicate a bevelled (angle-edged) look for the vector object or vector text you want to machine. For details, see "Bevel Carving" on page 428.



---

**Warning:** You cannot machine a Bevel Carving toolpath without using a 3-axis machine. For further information, consult a member of staff or your machine tool supplier.

---

- **Smart Engraving.** This toolpath allows you to engrave around the boundary of a vector object or group of vector text. You can use a range of tools with this strategy and ArtCAM Pro automatically calculates the order in which they should be used. For details, see "Smart Engraving" on page 434.
- **Drilling Holes.** This toolpath allows you to create drill holes using vector objects. For details, see "Drill Holes" on page 476.
- **Machine Vectors.** This toolpath allows you to machine along the boundary of a vector object with the centre of a tool. For details, see "Machine Vectors" on page 441.
- **Inlay Machining.** This toolpath allows you to create a selection of corresponding inlays (female) and inserts (male) from a vector object. For details, see "Inlay Wizard" on page 447.



## 2D Profiling

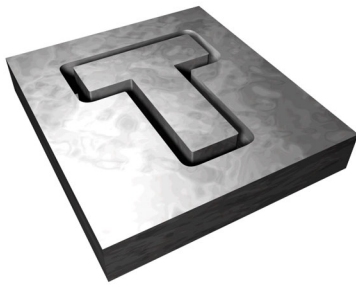



The **2D Profiling** button  in the **2D Toolpaths** area of the **Toolpaths** Home page allows you to create a toolpath that machines either inside or outside the boundary of a selected vector object, relative to the dimensions of the block of material.

A Profiling toolpath is ideal for cutting out letters and shapes from a block of material.

Using the **Profiling** page, you can:

- Control where your tool cuts into and retracts from the block of material by adding lead in and lead out moves.
- Control how your tool cuts into and retracts from the block of material by adding ramping moves.
- Control the cutting direction of the tool.
- Control whether the vector object is cut or snapped out from the block of material by defining the thickness of the final machine pass and/or adding bridging.

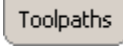
To profile a vector object:

1. Click on the **Toolpaths** tab  to display the **Toolpaths** Home page.
2. Select the vector object that you want to profile. For details, see "Selecting Vectors" in the Working with Vectors chapter.
3. Click on the **2D Profiling** button  in the **2D Toolpaths** area to display the **Profiling** page.
4. In the **Profile Side** area, select how you want to profile the selected vector object:
  - Click on the **Outside** radio button  to instruct the tool to profile outside of the selected vector object.
  - Click on the **Inside** radio button  to instruct the tool to profile inside of the selected vector object.

*Profile Side – Outside...*

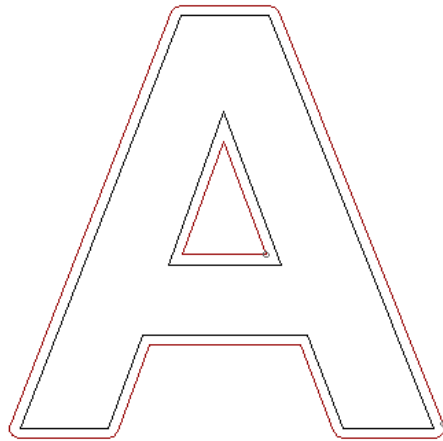

*Profile Side – Inside...*

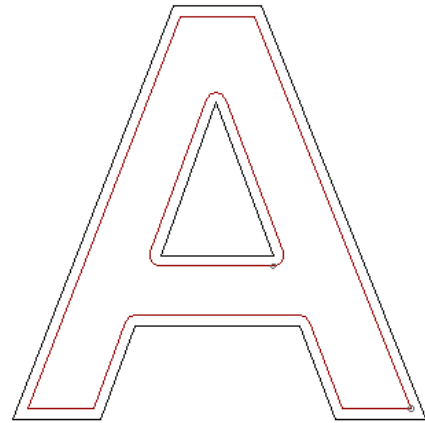

5. Define the depth (Z) at which you want to cut into the surface of the material in the **Start Depth** box.
6. Define the depth (Z) for the bottom of the cut in the **Finish Depth** box.
7. If you want to add or remove extra material around the vector object, define the distance between the boundary of the selected vector object and the profiling tool in the **Allowance** box. Type a positive value to add material or a negative value to remove it.

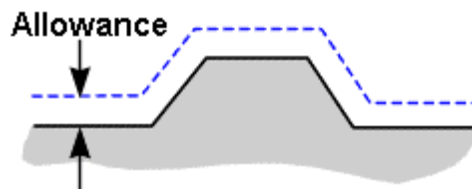

8. Define how closely you want the cutter to follow the shape of the vector object in the **Tolerance** box.
9. If you want to set the thickness of the final profile pass, click to select the **Final Pass Thickness** option , and then define its thickness in the adjacent box.

If this option is selected and a value greater than 0 is used, the toolpath consists of at least two machining passes, with the final pass removing the specified thickness (Z). This option is often used to leave a thin 'web' of material around the boundary of the vector objects being machined, with the last pass removing less material than the preceding passes. In this instance, you can gently snap the shape from the block of material.

10. If you want to add or remove extra material around the vector object, click to select the **Final Pass Allowance** option , and then define the allowance in the adjacent box.

If this option is selected, the allowance you define is left on by any of the intermediate machining passes in Z, and then removed in the final pass. This ensures that no dwell marks caused during the intermediate passes remain. The final pass (lowest in Z) machines the complete face of the profiled edge.

11. If you want to change the height at which the Profiling tool makes rapid moves between toolpath segments:

- First, click on the  arrow in the **Machine Safe Z** area to display the **Safe Z** box and the **Home Position's X, Y and Z** boxes.
- Next, define the height in the **Safe Z** box.

If you want to define the **Home Position** for the machining tool:

- First, define the X, Y and Z co-ordinates of the home position in the **Home Position's X, Y and Z** boxes.
- Next, click on the  arrow in the **Machine Safe Z** area to hide the **Safe Z** box and the **Home Position's X, Y and Z** boxes.

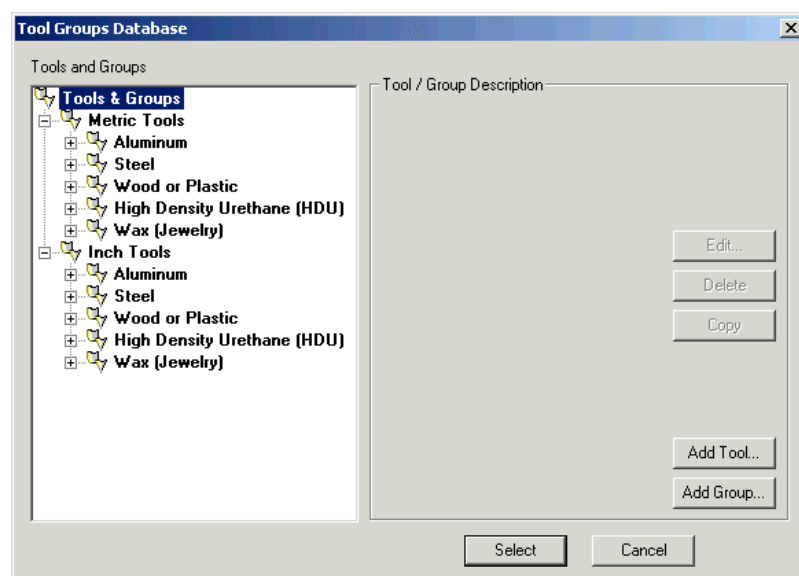

12. Click on the **Select** button in the **Profiling Tool** area of the page to open the **Tool Groups Database**:



13. Double-click on the tool you want to use. ArtCAM Pro closes the **Tool Groups Database** and displays the selected tool's description in the **Profiling Tool** area.

If you want to amend the machining parameters for the selected tool, click on the  arrow in the **Profiling Tool** area. For further information, see "Adjusting Machining Parameters When Creating a Toolpath" on page 540.

When you have finished, click on the  arrow to hide the machining parameters.

14. The cutting direction defaults to **Climb Mill**. If you want to change this, click on the  arrow in the **Cut Direction** area, then click on either of the **Cut Direction** radio buttons :

- **Climb Mill** - Climb Milling rotates the cutter in the same direction as the feed motion.
- **Conventional** – Conventional Milling rotates the cutter in the opposite direction to the feed motion.

For more details, see "Overview" on page 403.





---

**Note:** You can set the default cutting direction in ArtCAM Pro using the **ArtCAM Options** page. For details, see "Managing ArtCAM Pro's Preferences" in the ArtCAM Pro Layout chapter.

---

15. To add lead-in and lead-out moves to the toolpath, click to select the **Add Lead In/Out Moves** option . The lead moves settings are displayed:

- If you only want to have a lead-in move, click to select the **Do not Lead Out** option .
- Define the distance from the toolpath that you want the tool to cut into and retract from the vector object's boundary in the **Distance (D)** box.
- Define the distance from the start/end point in the profile pass that you want the tool to machine over in the **Over Cut (O)** box. This further helps to create a smooth finish.
- Select how you want the tool to move using the **Add Lead In/Out Moves** radio buttons .

**Linear** – Click on the **Linear** option  to instruct the tool to lead into and out of the vector object's boundary in a straight-line motion:

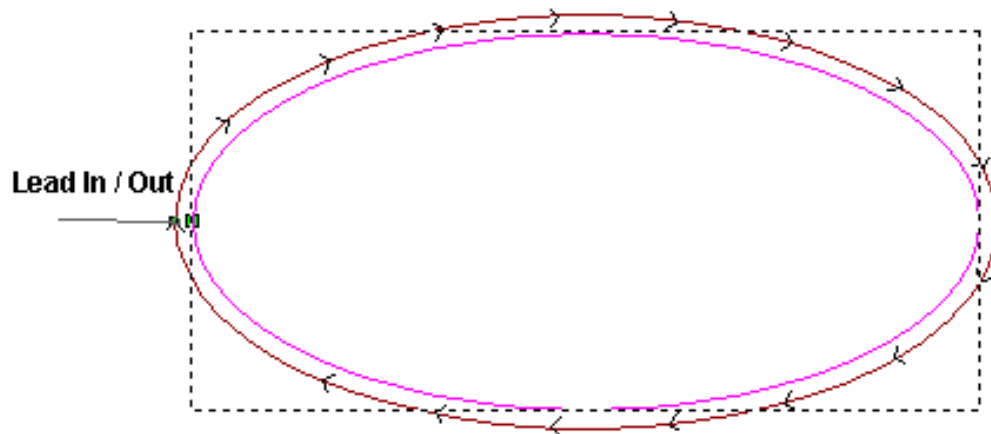

If you select the **Linear** option, define the angle of the linear lead moves in the **Angle In** and **Angle Out** boxes.

When editing lead moves associated with a profile pass used to machine inside of a defined area, the distance of a linear lead move or the radius of a circular arc move is now considered.

When adjusting the position of a linear lead move, ArtCAM checks to ensure that the distance of the lead move remains within the boundary of the profile pass. If the current distance of the lead move intersects with the profile pass, its distance will be cropped so that it does not.

When adjusting the position of a circular arc lead move, ArtCAM checks to ensure that the radius of the lead move remains within the boundary of the profile pass. If the current radius of the lead move intersects with the profile pass, the lead move is converted to a linear move instead with a distance that does not.

**Circular Arc** – Click on the **Circular Arc** option  to instruct the tool to lead into and out of the vector object's boundary in an arc motion:

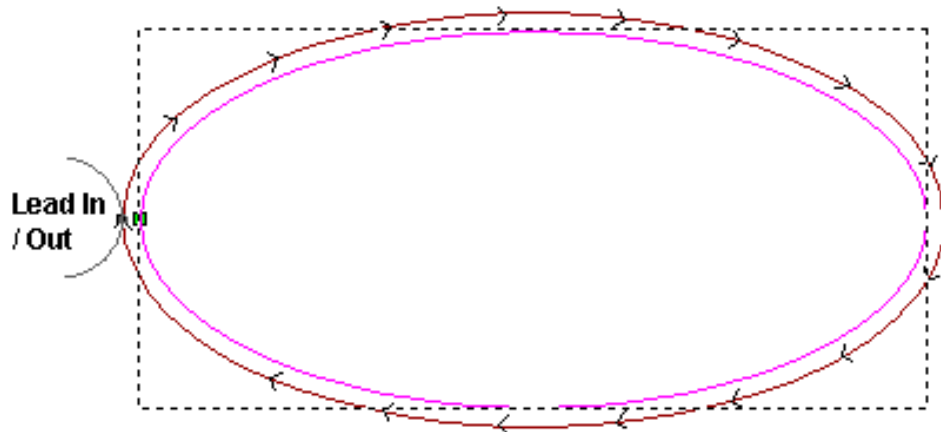

If you select the **Circular Arc** option, define the radius of the arc in the **Radius (R)** box. The radius must be less than or equal to the value in the **Distance (D)** box, otherwise the following message box appears when you calculate the toolpath:

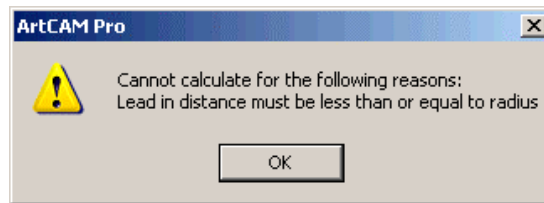

Click on the **OK** button to close the message box.

- Set the Automatic Positioning as follows:

Click to select the **Automatic Positioning** option . This positions lead-in and lead-out moves at the optimum point in the vector object, which is usually within its longest linear span.



---

**Note:** The **Automatic Positioning** option should not be selected if you want to use the **Lock Start Points** option for toolpath sequencing.

---

Click to deselect the **Automatic Positioning** option . This positions lead-in and lead-out moves at the Start Point of the vector object. If you want to change the position of lead-in and lead-out moves, you can change the Start Point. See "Changing the Start Point" in the Working with Vectors chapter for details.

16. To add ramping moves to the toolpath, click to select the **Add Ramping Moves** option . The ramping moves settings are displayed:

All of the ramping move settings are selected by default . If you do not want to use any of these settings, click to deselect each of those you do not require . The boxes for the deselected options are greyed-out.

You can use the ramping move settings as follows:

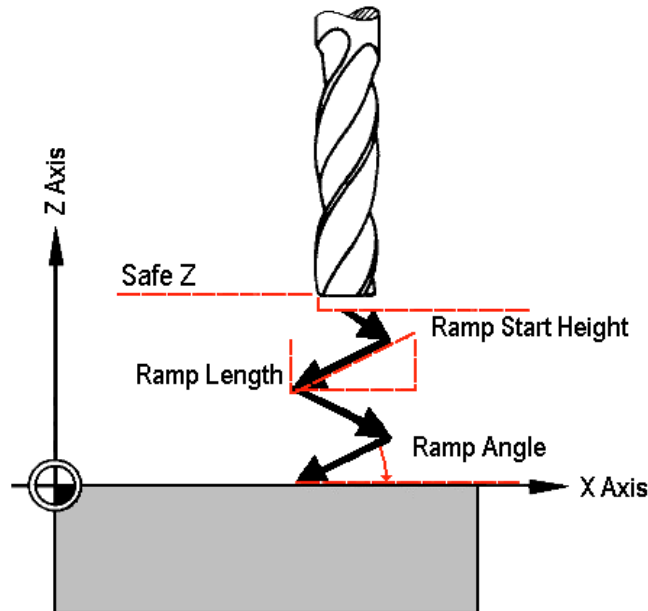

- Define the maximum angle of descent for each zig and zag movement of the cutting tool in the **Max Ramp Angle (A)** box.
- Define the maximum distance that you want the cutting tool to zigzag across the material surface in the **Max Ramp Length (L)** box.
- Define the minimum distance that you want the tool to zigzag across the material surface in the **Min Ramp Length (Lmin)** box.
- If you want to set the height at which the ramping moves start, click to select the **Ramp Start Height (S)** option , and then define the start height in the box beneath. If you do not define the **Ramp Start Height (S)** here, the **Safe Z** level is used by default.

17. From the **Sequencing** area, you can set the order in which each segment in the toolpath is machined. You can either allow ArtCAM Pro to calculate the machining order, or use a polyline drawn to indicate the machining order.

If you want to ArtCAM Pro to calculate the order in which each segment in the toolpath is machined:

- First, click on the **Auto** radio button .
- Next, click on the list box and then on the option that you want to use for the machining order:

**Optimise** – Click on this option to instruct ArtCAM Pro to find the most efficient machining order.

**Use Text Order** – Click on this option to instruct ArtCAM Pro to machine according to the order in which the selected vector text was created. The cutting tool moves along the first line of text from left to right, until it locates a carriage return when it continues machining along the next line from right to left. This process is repeated until the last character in the last line of text is located.

**Left To Right** – Click on this option to instruct ArtCAM Pro to machine from the left of the model to the right.

**Right To Left** – Click on this option to instruct ArtCAM Pro to machine from the right of the model to the left.

**Bottom To Top** – Click on this option to instruct ArtCAM Pro to machine from the bottom of the model to its top.

**Top To Bottom** – Click on this option to instruct ArtCAM Pro to machine from the top of the model to the bottom.

**Spiral Out** – Click on this option to instruct ArtCAM Pro to machine from the centre of the model outwards in a spiral motion. This is particularly useful if you are using clamps to secure the material on your router.

**Spiral In** – Click on this option to instruct ArtCAM Pro to machine from the outside edge of the model inwards in a spiral motion.

If you want to manually set the order in which each segment in the toolpath is machined:

- First, click on the **Manual** radio button .



- Next, draw a polyline in the **2D View** indicating the order in which you want the toolpath segments to be machined. Its Start Point should be positioned close to the toolpath segment from which you want to begin machining. For details, see "Creating a Polyline" in the Working with Vectors chapter.
- Next, click to select the polyline that you want to use, and then click on the **Select Vector** button. The *No Vector Selected* message in red text changes to *Vector Selected* in blue text.

If you do not select an open, ungrouped vector object, the following message box appears:

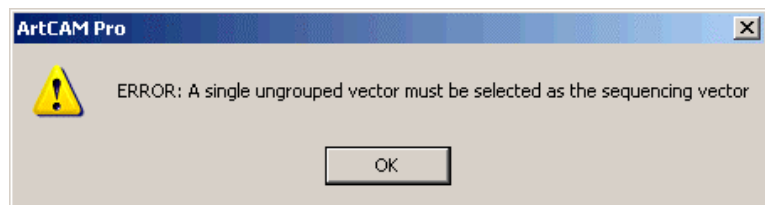

Click on the **OK** button to close the message box, and then repeat this step.

If you want to change the polyline you have selected, click on the **Cancel Selection** button and then repeat this step.

- Finally, make sure that the vector object(s) that you want to profile are selected. For details, see "Selecting Vectors" in the Working with Vectors chapter.

If you do not want ArtCAM Pro to adjust the position of the Start Point within a toolpath segment when calculating the machining order, make sure that the **Lock Start Points** option is selected . Deselecting this option prevents ArtCAM Pro from attempting to minimise the length of joining moves in the machining process.



---

**Note:** The **Lock Start Points** option should not be selected if you have already selected the **Automatic Positioning** option for lead moves. Using the **Lock Start Points** option will cancel the **Automatic Positioning** option.

---

18. In the **Material** area, click on the **Setup** button to display to display the **Material Setup** dialog box.

Make sure that the thickness of the block, the material Z zero position and the position of the model in the block is correct, then click on the **OK** button. If you want to change any of these settings, see "Adjusting the Material Setup" on page 562.

19. If you do not want to preview the toolpath in the **2D View** window, click to deselect the **Create 2D Preview** option .
20. Type a name for the toolpath in the **Name** box.
21. You can now specify when you want to calculate the toolpath:
  - If you want to calculate the toolpath now, click on the **Now** button. The **Offsetting Contours** dialog box is displayed while ArtCAM Pro calculates the toolpath:

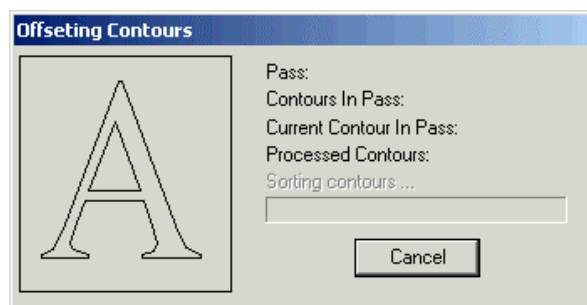

A dark red line represents the machining passes used to profile the selected vector object. It is drawn either inside or outside of its boundary, according to the **Profile Side** that you had selected. A circle marking the current start position is drawn on the toolpath preview. For details, see "Changing the Start Position" on page 533.

The toolpath preview is not shown if the **Create 2D Preview** option is deselected .

You can now simulate the toolpath. For details, see "Simulating Toolpaths" on page 567.

- If you want to calculate the toolpath as part of a batch of toolpaths at a later time, click on the **Later** button. For details, see "Calculating a Single Toolpath" on page 548 and "Calculating a Batch of Toolpaths" on page 549.

22. Click on the **Close** button to return to the **Toolpaths** Home page.

If you want to add bridges to or change the start position in any of the profile passes in the Profile toolpath, see "Editing a Profile Pass" on page 527.

If you want to set the machining order of the profile passes in the Profile toolpath, see "Setting the Machining Order" on page 537.

## 2D Area Clearance

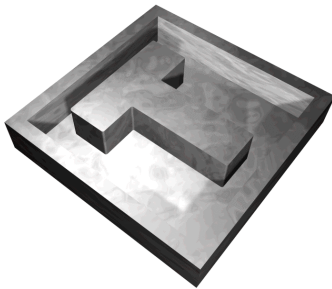



The **Area Clearance** button  in the **2D Toolpaths** area of the **Toolpaths** Home page allows you to create a toolpath to clear an area of material based on the boundary of the vector object you have selected.

An Area Clearance toolpath is ideal for clearing areas of unwanted material in a block of material.

Using the **2D Area Clearance** page, you can:

- Select multiple tools to perform *smart machining*, where ArtCAM Pro automatically uses the biggest tool first, and then the smaller tools in order of size to machine the areas which could not be reached by previous tools.
- Select a different tool clearance strategy for each of the tools you want to use. Depending on what strategy you select, you can control the angle, or where and in what direction the tool cuts into the block of material.
- Control how your tools cut into and retract from the block of material by adding ramping moves.

To area clear a vector object:

1. Click on the **Toolpaths** tab  to display the **Toolpaths** Home page.
2. Select the vector objects that represent the area you want to clear. For details, see "Selecting Vectors" in the Working with Vectors chapter.
3. Click on the **Area Clearance** button  in the **2D Toolpaths** area of the **Toolpaths** Home page to display the **2D Area Clearance** page.

4. Define the depth (Z) from the surface of the material at which you want to begin clearing the area in the **Start Depth** box.
5. Define the depth (Z) of the bottom of the area you want to clear in the **Finish Depth** box.
6. If you want to add or remove extra material around the vector object, define the distance between the boundary of the selected vector object and the cutting tool in the **Allowance** box. Type a positive value to add material or a negative value to remove it.
7. If you are using more than one tool, define the allowance to be left by larger tools for the smallest tool to machine when clearing around the selected vector objects in the **Final Tool Allowance** box.
8. Define how closely you want the cutting tool(s) to follow the shape of the vector object in the **Tolerance** box.
9. If you want to change the height at which a cutting tool makes rapid moves between toolpath segments:

- First, click on the  arrow in the **Machine Safe Z** area to display the **Safe Z** box and the **Home Position's X, Y and Z** boxes.
- Next, define the height in the **Safe Z** box.

If you want to define the **Home Position** for the machining tool(s):

- First, define the X, Y and Z co-ordinates of the home position in the **Home Position's X, Y and Z** boxes.
  - Next, click on the  arrow in the **Machine Safe Z** area to hide the **Safe Z** box and the **Home Position's X, Y and Z** boxes.
10. In the **Tools List** area, click on the **Add** button to open the **Tool Groups Database**:

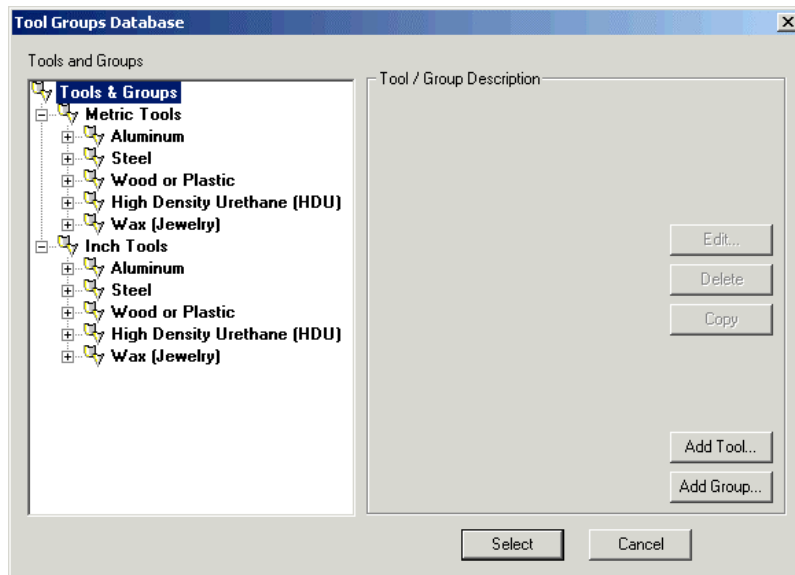

11. Double-click on the tool you want to use. ArtCAM Pro closes the **Tool Groups Database** and displays the selected tool's description in the **Tools List** window.

The tool's machining parameters are displayed in the area below. If you want to amend the machining parameters, see "Adjusting Machining Parameters When Creating a Toolpath" on page 540.

When you have finished, click on the  arrow to hide the machining parameters.

12. If you want to use more than one tool, click on the **Add** button again and select another tool from the **Tool Groups Database**.
13. In the **Tools List** window, click on the name of the tool for which you want to set the clearance strategy. You must select a separate tool clearance strategy for each of the tools listed.
14. Select how you want the tool to clear the area using the **Tool Clearance Strategy** radio buttons :
  - **Raster** - This strategy machines in passes back and forth along the X-axis at a specified angle. If you select this strategy, define the angle at which you want the tool to move in the **Raster Angle** box.



---

**Note:** You can set the default raster angle using the **ArtCAM Options** page. For details, see "Managing ArtCAM Pro's Preferences" in the ArtCAM Pro Layout chapter.

---

- **Offset** - This strategy machines in repeated passes, each time moving inwards by the selected tool's **Stepover** value.





---

**Note:** You can see the stepover value of the selected tool when the machining parameters are displayed in the **Tools List** area.

---

*Raster Tool Clearance at 45°...*

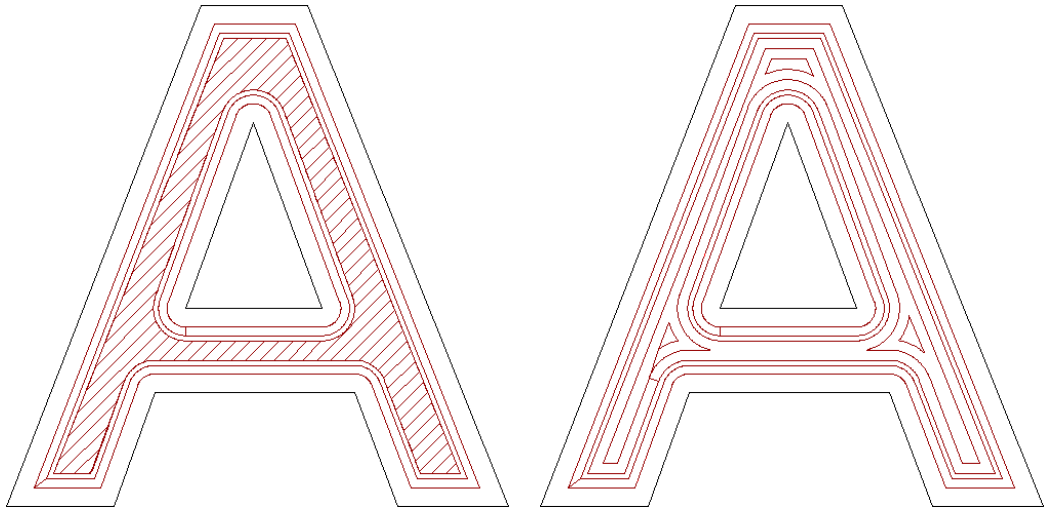
*Offset Tool Clearance...*



If you select **Offset**, click on one of the **Cut Direction** radio buttons :

**Climb Mill** – In Climb Milling, the cutter rotates in the same direction as the feed motion.

**Conventional** – In Conventional Milling, the cutter rotates in the opposite direction to the feed motion.  
For more details, see "Overview" on page 403.



---

**Note:** You can set the default cutting direction in ArtCAM Pro using the **ArtCAM Options** page. For details, see "Managing ArtCAM Pro's Preferences" in the ArtCAM Pro Layout chapter.

---

Next, click on either of the **Start Point** radio buttons :

**Outside** - Select this option if you want the tool to cut into the material at the vector object's boundary, then machine inwards.

**Inside** - Select this option if you want the tool to cut into the material at the vector object's centre, then machine outwards.



---

**Note:** You can set the default offset start point using the **ArtCAM Options** page. For details, see "Managing ArtCAM Pro's Preferences" in the ArtCAM Pro Layout chapter.

---

15. If you want the selected tool to cut to a different depth than that displayed in the **Finish Depth** box, click to select the **Independent Finish Depth** option , and then define the relative depth (Z) of the bottom of the area you want to clear in the **Finish Depth** box below.
16. When you have set a tool clearance strategy for each of the tools in the **Tools List** area, you can choose whether or not to add ramping moves to the machining passes made by them:
  - To add ramping moves to the toolpath, click to select the **Add Ramping Moves** option . The ramping move settings are displayed.

All of the ramping move settings are selected by default . If you do not want to use any of these settings, click to deselect each of those you do not require . The boxes for the deselected options are greyed-out.

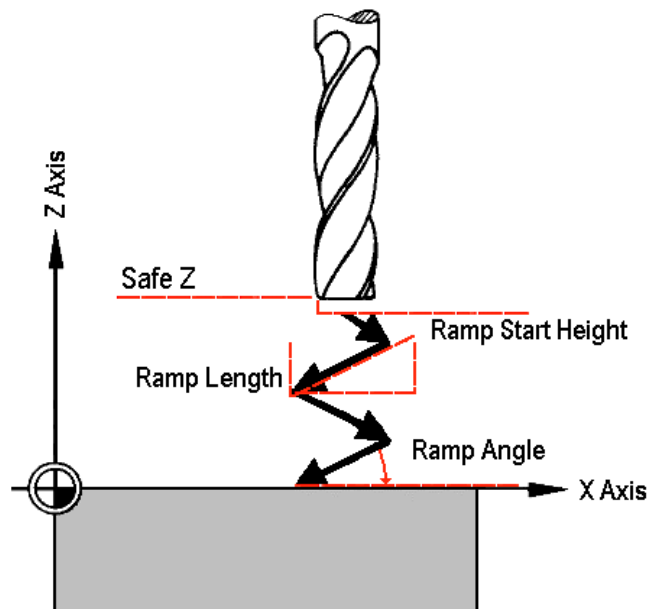

- Define the maximum angle of descent for each zig and zag movement of the cutting tool in the **Max Ramp Angle (A)** box.

- Define the maximum distance that you want the cutting tool to zigzag across the material surface in the **Max Ramp Length (L)** box.
  - Define the minimum distance that you want the tool to zigzag across the material surface in the **Min Ramp Length (Lmin)** box.
  - If you want to set the height at which the ramping moves start, click to select the **Ramp Start Height (S)** option , and then define the start height in the box beneath. If you do not define the **Ramp Start Height (S)** here, the **Safe Z** level is used by default.
17. In the **Material** area, click on the **Setup** button to display the **Material Setup** dialog box.
- Make sure that the thickness of the block, the material Z zero position and the position of the model in the block is correct, then click on the **OK** button. If you want to change any of these settings, see "Adjusting the Material Setup" on page 562.
18. If you do not want to preview the toolpath in the **2D View** window, click to deselect the **Create 2D Preview** option .





---

**Tip:** It is recommended that you create a 2D preview. You can always hide it from view by clicking on the **2D** option in the **Show in** area of the **Toolpaths** Home page.

---

19. Type a name for the toolpath in the **Name** box.
20. You can now specify when you want to calculate the toolpath:
- If you want to calculate the toolpath now, click on the **Now** button.

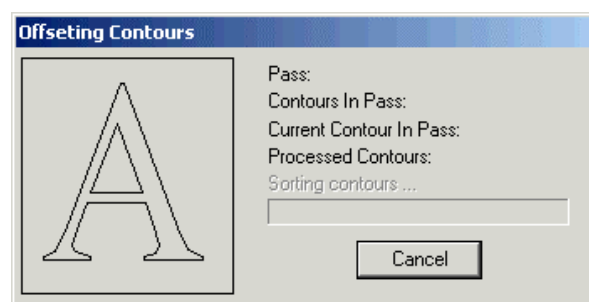
The **Offsetting Contours** dialog box is displayed while ArtCAM Pro calculates the toolpath:





The machining passes used to clear the area about the selected vector object are represented by a sequence of dark red lines drawn either inside or outside of its boundary.

The toolpath preview is not shown if the **Create 2D Preview** option is deselected .

You can now simulate the toolpath. For details, see "Simulating Toolpaths" on page 567.

- If you want to calculate the toolpath at a later time, click on the **Later** button. For details, see "Calculating a Single Toolpath" on page 548 and "Calculating a Batch of Toolpaths" on page 549.

21. Click on the **Close** button to return to the **Toolpaths** Home page.

## V-Bit Carving



---

**Warning:** You cannot machine a V-Bit Carving toolpath without using a 3-axis machine. For further information, consult a member of staff or your machine tool supplier.



---



The **V-Bit Carving** button  in the **2D Toolpaths** area of the **Toolpaths** Home page allows you to create a toolpath that replicates a hand carved look for the vector object or text that you have selected.

The **V-Bit Carving** page allows you to control the depth of the centreline carved into the block of material and the order in which toolpath segments are machined.

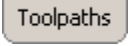
To v-bit carve vector objects or text:

1. Click on the **Toolpaths** tab  to display the **Toolpaths** Home page.
2. Select the vector object or text that you want to carve. For details, see "Selecting Vectors" in the Working with Vectors chapter.
3. Click on the **V-Bit Carving** button  in the **2D Toolpaths** area of the **Toolpaths** Home page to display the **V-Bit Carving** page.

4. Define the depth (Z) from the material surface at which you want to begin carving in the **Start Depth** box.
5. Define how closely you want the Carving tool(s) to follow the shape of the vector object in the **Tolerance** box.
6. If you want to change the height at which the Carving tool makes rapid moves between toolpath segments:

- First, click on the  arrow in the **Machine Safe Z** area to display the **Safe Z** box and the **Home Position's X, Y and Z** boxes.
- Next, define the height in the **Safe Z** box.

If you want to define the **Home Position** for the machining tool:

- First, define the X, Y and Z co-ordinates of the home position in the **Home Position's X, Y and Z** boxes.
- Next, click on the  arrow in the **Machine Safe Z** area to hide the **Safe Z** box and the **Home Position's X, Y and Z** boxes.

7. In the **Carving Tool** area, click on the **Select** button to open the **Tool Groups Database**:

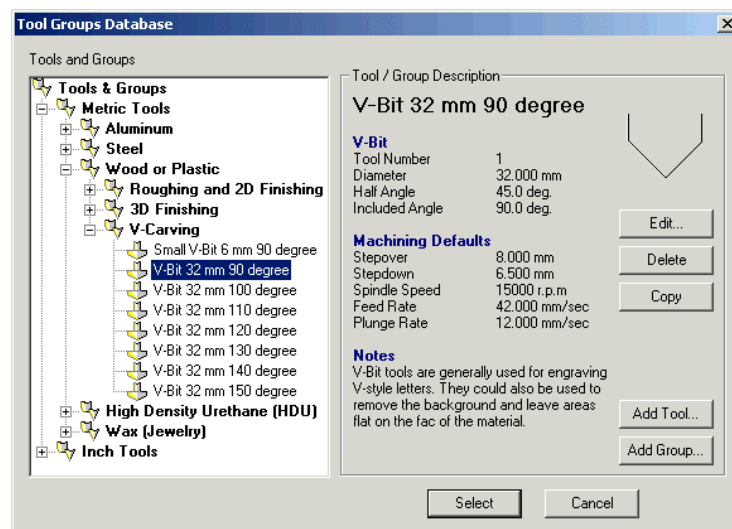

8. Double-click on the V-Bit, Conical or Ball Nose tool that you want to use. ArtCAM Pro closes the **Tool Groups Database** and displays the selected tool's description in the **Carving Tool** area.

If you want to amend the machining parameters, click on the  arrow in the **Carving Tool** area. For further details,

see "Adjusting Machining Parameters When Creating a Toolpath" on page 540.

When you have finished, click on the  arrow to hide the machining parameters.

9. From the **Sequencing** area, you can set the order in which each segment in the toolpath is machined. You can either allow ArtCAM Pro to calculate the machining order, or use a polyline drawn to indicate the machining order.

If you want to ArtCAM Pro to calculate the order in which each segment in the toolpath is machined:

- First, click on the **Auto** radio button .
- Next, click on the list box and then on the option that you want to use for the machining order:

**Optimise** – Click on this option to instruct ArtCAM Pro to find the most efficient machining order.

**Use Text Order** – Click on this option to instruct ArtCAM Pro to machine according to the order in which the selected vector text was created. The cutting tool moves along the first line of text from left to right, until it locates a carriage return when it continues machining along the next line from right to left. This process is repeated until the last character in the last line of text is located.

**Left To Right** – Click on this option to instruct ArtCAM Pro to machine from the left of the model to the right.

**Right To Left** – Click on this option to instruct ArtCAM Pro to machine from the right of the model to the left.

**Bottom To Top** – Click on this option to instruct ArtCAM Pro to machine from the bottom of the model to its top.

**Top To Bottom** – Click on this option to instruct ArtCAM Pro to machine from the top of the model to the bottom.

**Spiral Out** – Click on this option to instruct ArtCAM Pro to machine from the centre of the model outwards in a spiral motion. This is

particularly useful if you are using clamps to secure the material on your router.

**Spiral In** – Click on this option to instruct ArtCAM Pro to machine from the outside edge of the model inwards in a spiral motion.

If you want to manually set the order in which each segment in the toolpath is machined:

- First, click on the **Manual** radio button .
- Next, draw a polyline in the **2D View** indicating the order in which you want the toolpath segments to be machined. Its Start Point should be positioned close to the toolpath segment from which you want to begin machining. For details, see "Creating a Polyline" in the Working with Vectors chapter.
- Next, click to select the polyline that you want to use, and then click on the **Select Vector** button. The *No Vector Selected* message in red text changes to *Vector Selected* in blue text.

If you do not select an open, ungrouped vector object, the following message box appears:

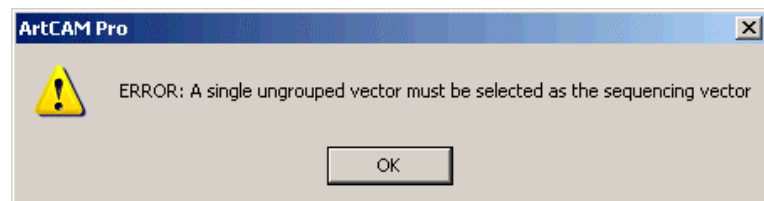

Click on the **OK** button to close the message box, and then repeat this step.

If you want to change the polyline you have selected, click on the **Cancel Selection** button and then repeat this step.



- Finally, make sure that the vector object(s) that you want to carve are selected. For details, see "Selecting Vectors" in the Working with Vectors chapter.
10. You can now calculate the maximum depth and width of the carving pass in the toolpath by clicking on the **Centreline** button.



---

**Note:** If you have chosen a Carving tool with a smaller diameter than the maximum width of the carving pass, ArtCAM Pro makes multiple passes to clear the specified width.

---

During the centreline calculation process, ArtCAM Pro displays a progress bar and a **Cancel** button  beneath the design window area. If you want to stop this process, click on the **Cancel** button .

After the centreline calculation process is complete, the maximum depth and width of the carving pass are shown below the **Carving Tool** area.

If the maximum depth of the carving pass is greater than the thickness of the material block, the following message box appears when the toolpath is calculated:

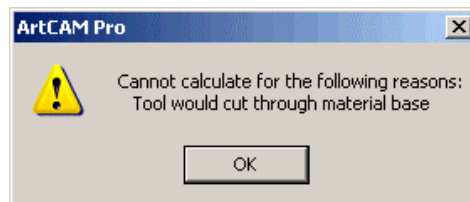

Click on the **OK** button to close the message box. To overcome this problem, you can select a different Carving tool with an angled edge, limit the maximum depth of the tool or use a thicker block of material.

11. To limit the depth at which the Carving tool cuts into the block of material:
  - First, click to select the **Limit tool maximum depth** option  in the **Carving Tool** area.
  - Next, type a value in the **Maximum Depth** box equal to the **Max Depth** value shown above the **Centreline** button.



---

**Warning:** If you were to use a value less than the calculated **Max Depth**, the carving would be truncated.

---

12. In the **Material** area, click on the **Setup** button to display the **Material Setup** dialog box.

Make sure that the thickness of the block, the material Z zero position and the position of the model in the block is correct, then click on the **OK** button. If you want to change

any of these settings, see "Adjusting the Material Setup" on page 562.

13. If you do not want to preview the toolpath in the **2D View** window, click to deselect the **Create 2D Preview** option .



---

**Tip:** It is recommended that you create a 2D preview. You can always hide it from view by clicking on the **2D** option in the **Show in** area of the **Toolpaths** Home page.

---

14. Type a name for the toolpath in the **Name** box.
15. You can now specify when you want to calculate the toolpath:

- If you want to calculate the toolpath now, click on the **Now** button.

If you have not already calculated the carving pass in the toolpath, the selected vector object is colour-filled in cyan during the centreline calculation process.

Dark red lines drawn inside its boundary represent the machining passes used to carve the selected vector object.

The toolpath preview is not shown if the **Create 2D Preview** option is deselected .

You can now simulate the toolpath. For details, see "Simulating Toolpaths" on page 567.

- If you want to calculate the toolpath at a later time, click on the **Later** button. See "Calculating a Single Toolpath" on page 548 and "Calculating a Batch of Toolpaths" on page 549 for details.

16. Click on the **Close** button to return to the **Toolpaths** Home page.

## Bevel Carving



---

**Warning:** You cannot machine a Bevel Carving toolpath without using a 3-axis machine. For further information, consult a member of staff or your machine tool supplier.

---



The **Bevel Carving** button  in the **2D Toolpaths** area of the **Toolpaths** Home page allows you to create a toolpath that replicates a bevelled (angled-edge) look for the vector text or object that you have selected.

To create a bevel carving, you must use two types of tool:



- An angled-edge carving tool to create the bevelled edge.
- A profiling tool to create the vertical wall below the bevelled edge.

The angle of the bevelled edge is determined by the angle of the carving tool.

Using the **Bevel Carving** page, you can:

- Choose whether or not you want to create a vertical wall in the bevel carving.
- Control the height of the angled edge in the bevel carving.
- Control the cutting direction of the tool.

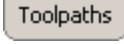
To begin bevelling your vector text or object you must:

1. Click on the **Toolpaths** tab  to display the **Toolpaths** Home page.
2. Select the vector object from which you want to create a bevel carving. For details, see "Selecting Vectors" in the Working with Vectors chapter.
3. Click on the **Bevel Carving** button  in the **2D Toolpaths** area of the **Toolpaths** Home page to display the **Bevel Carving** page.
4. Define the depth (Z) from the material surface at which you want to begin carving in the **Start Depth** box. This is the apex of the bevel carved object.
5. Define the height of the wall in the material block in the **Wall Height** box. This is the vertical wall below the bevelled edge.



---

**Note:** If you do create a vertical wall, a Profiling tool must be used when machining.

---

- Define the depth (Z) for the bottom of the cut in the **Finish Depth** box.



**Note:** If you are cutting the vector object out of the block of material, the **Finish Depth** value must be equal to the **Thickness (Z)** defined in the **Setup Job Dimensions** dialog box. For details, see "Creating a Model" in the Working with Models chapter.

- Define how closely you want the Carving and Profiling tools to follow the shape of the vector object in the **Tolerance** box.
- If you want to change the height at which the Carving and Profiling tools make rapid moves between toolpath segments:
  - First, click on the  arrow in the **Machine Safe Z** area to display the **Safe Z** box and the **Home Position's X, Y and Z** boxes.
  - Next, define the height in the **Safe Z** box.

If you want to define the **Home Position** for the machining tools:

- First, define the X, Y and Z co-ordinates of the home position in the **Home Position's X, Y and Z** boxes.
  - Next, click on the  arrow in the **Machine Safe Z** area to hide the **Safe Z** box and the **Home Position's X, Y and Z** boxes.
- In the **Carving Tool** area, click on the **Select** button to open the **Tool Groups Database**:

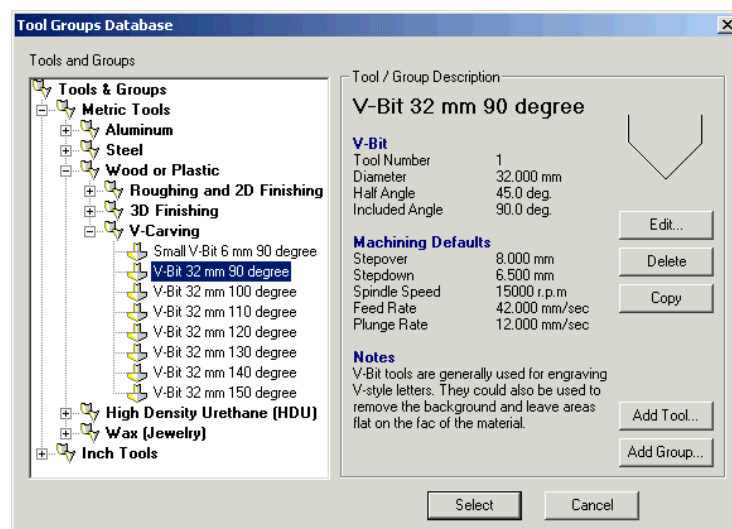





10. Double-click on the V-Bit or Conical tool you want to use. ArtCAM Pro closes the **Tool Groups Database** and displays the selected tool's description in the **Carving Tool** area.

If you want to amend the machining parameters, click on the ▼ arrow in the **Carving Tool** area. For further details, see "Adjusting Machining Parameters When Creating a Toolpath" on page 540.

When you have finished, click on the ▲ arrow to hide the machining parameters.

11. You can now calculate the maximum height and width of the carving pass in the toolpath by clicking on the **Centreline** button.

During the centreline calculation process, ArtCAM Pro displays a progress bar and a **Cancel** button  beneath the design window area. If you want to stop this process, click on the **Cancel** button .



---

**Note:** If you have chosen a Carving tool with a smaller diameter than the maximum width of the carving pass, ArtCAM Pro makes multiple passes to clear the specified width of the carving pass.

---

After the centreline calculation process is complete, the maximum depth and width of the carving pass are shown below the **Carving Tool** area.

If the maximum depth of the carving pass is greater than the thickness of the material block, the following message box appears when the toolpath is calculated:

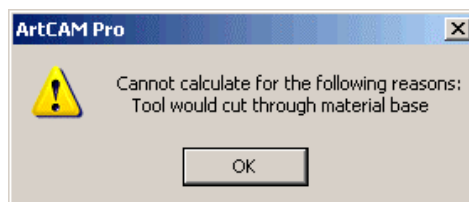

Click on the **OK** button to close the message box. To overcome this problem, you can select a different Carving tool with a smaller angled edge, limit the maximum depth of the tool or use a thicker block of material.

12. To limit the depth at which the Carving tool cuts into the block of material:

- First, click to select the **Limit tool maximum depth** option  in the **Carving Tool** area.
- Next, type a value in the **Maximum Depth** box equal to the **Max Depth** value shown below the **Carving Tool** area.





---



**Warning:** If you were to use a value less than the calculated **Max Depth**, the carving would be truncated.

---

13. Click on the **Select** button in the **Profiling Tool** area of the page to open the **Tool Groups Database** again.
14. Double-click on the tool you want to use to display its description in the **Profiling Tool** area.

If you want to amend the machining parameters, click on the  arrow in the **Profiling Tool** area. For further details, see "Adjusting Machining Parameters When Creating a Toolpath" on page 540.

When you have finished, click on the  arrow to hide the machining parameters.

15. To set the cut direction of the **Profiling Tool**, click on the  arrow in the **Cut Direction** area, and then click on either of the **Cut Direction** radio buttons :
  - **Climb Mill** – In Climb Milling, the cutter rotates in the same direction as the feed motion.
  - **Conventional** – In Conventional Milling, the cutter rotates in the opposite direction to the feed motion. For more details, see "Overview" on page 403.
16. In the **Material** area, click on the **Setup** button to display the **Material Setup** dialog box.
 

Make sure that the thickness of the block, the material Z zero position and the position of the model in the block is correct, then click on the **OK** button. If you want to change any of these settings, see "Adjusting the Material Setup" on page 562.
17. If you do not want to preview the toolpath in the **2D View** window, click to deselect the **Create 2D Preview** option .



---

**Tip:** It is recommended that you create a 2D preview. You can always hide it from view by clicking on the **2D** option in the **Show in** area of the **Toolpaths** Home page.

---

18. Type a name for the toolpath in the **Name** box.
19. You can now specify when you want to calculate the toolpath:

- If you want to calculate the toolpath now, click on the **Now** button. If you have not already calculated the carving pass in the toolpath, the selected vector object is colour-filled in cyan during the centreline calculation process.

The **Offsetting Contours** dialog box is displayed while ArtCAM Pro calculates each profile pass in the toolpath:

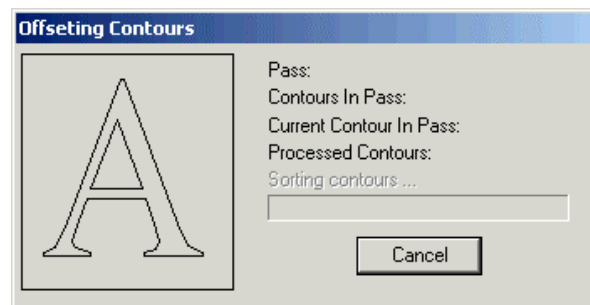

A dark red line represents the machining passes used to profile the selected vector object in the model. Each profile pass is drawn outside of the vector object's boundary. The toolpath preview is not shown if the **Create 2D Preview** option is deselected .

A circle marking the current start position is drawn on the toolpath preview. For details, see "Changing the Start Position" on page 533.

You can now simulate the toolpath. For details, see "Simulating Toolpaths" on page 567.

- If you want to calculate the toolpath at a later time, click on the **Later** button. See "Calculating a Single Toolpath" on page 548 and "Calculating a Batch of Toolpaths" on page 549 for details.
20. Click on the **Close** button to return to the **Toolpaths** Home page.

If you want to add bridges to, add lead moves to, or change the start position in any of the profile passes in the Bevelled Carving toolpath, see "Editing a Profile Pass" on page 527.

If you want to set the machining order of the profile passes in the Bevelled Carving toolpath, see "Setting the Machining Order" on page 537.

## ***Help with Creating a Bevelled Carving***

You can display information on how to create a Bevelled Carving toolpath if you click on **Show Help** at the top of the **Bevel Carving** page.

However, if you would like further assistance with creating a Bevelled Carving toolpath:

1. Click on the **More Help** button at the bottom of the page to display the **Bevelled Carving Help** window.
2. Click on either of the **Step 1** radio buttons  to display its corresponding **Step 2** in the window:
  - **I want to cut the bevelled carving out of the material** – Select this option if you want to remove the bevelled carving from the block of material.
  - **The bevelled carving sits within a bigger job** – Select this option if you do not want to remove the bevelled carving from the block of material.
3. Once you have read the information displayed, click on the **Close Window** button to close the **Bevelled Carving Help** window.

## **Smart Engraving**



The **Engraving** button  in the **2D Toolpaths** area of the **Toolpaths** Home page allows you to create a toolpath that engraves the vector text or object that you have selected.



Using the **Smart Engraving** page, you can:

- Select multiple tools to perform *smart engraving*, where ArtCAM Pro automatically selects the biggest tool first, and then the smaller tools in order of size. This provides the most efficient way of machining, as the bigger tools clear

the material and the smaller ones can then machine smaller pockets to provide the engraved detail.

- Select a different tool clearance strategy for each of the tools you want to use. Depending on what strategy you select, you can control the angle, or where and in what direction the tool cuts into the block of material.
- Control the areas that the Engraving tool sharpens and profiles.
- Offset the Roughing tool so to leave sufficient material for the Engraving tool to form the side of the engraved feature.

To engrave a vector object:

1. Click on the **Toolpaths** tab  to display the **Toolpaths** Home page.
2. Select the vector object that you want to engrave. For details, see "Selecting Vectors" in the Working with Vectors chapter.
3. Click on the **Engraving** button  in the **2D Toolpaths** area of the **Toolpaths** Home page to display the **Smart Engraving** page.
4. Define the depth (Z) from the material surface at which you want to begin engraving in the **Start Depth** box.
5. Define the depth (Z) for the bottom of the cut in the **Finish Depth** box.
6. Define how closely you want the Roughing and Engraving tools to follow the shape of the vector object in the **Tolerance** box.
7. To place the Engraving tool in contact with the top edge of the vector object during the machining process, make sure that the **Vectors are on surface** option is selected .  
If the **Vectors are on surface** option is deselected , the Engraving tool is placed in contact with the bottom edge of the vector object during the machining process. The **Do Corner Sharpening** option is also automatically greyed out.
8. If you are engraving one vector object inside of another, and do not want the Engraving tool to sharpen the corners or

machine the boundary of the outer vector object, click to select the **Outer vectors are boundary** option .

In the example below, you can see that the engraving tool machines along the boundary and sharpens the corners of the outer rectangular vector object when the **Outer vectors are boundary** option is deselected :

*Outer Vectors are boundary  
OFF ...*

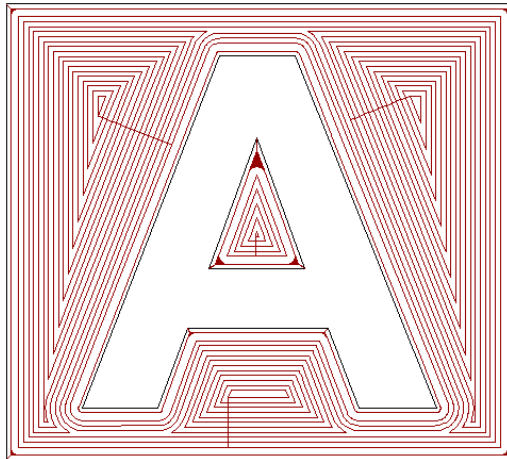

*Outer Vectors are boundary  
ON ...*

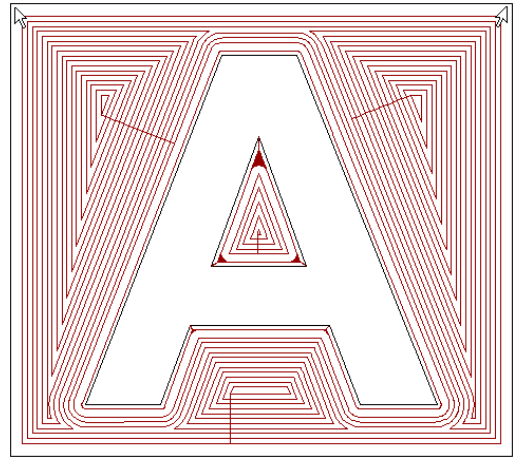

9. To automatically offset an End Mill Roughing tool in order to leave sufficient material for an angle-edged of an Engraving tool to form the side of the engraved feature, click to select the **Offset end mills for engraving tools** option .
10. If you want to change the height at which the Roughing and Engraving tools make rapid moves between toolpath segments:
  - First, click on the  arrow in the **Machine Safe Z** area to display the **Safe Z** box and the **Home Position's X, Y and Z** boxes.
  - Next, define the height in the **Safe Z** box.

If you want to define the **Home Position** for the machining tool:

- First, define the X, Y and Z co-ordinates of the home position in the **Home Position's X, Y and Z** boxes.
- Next, click on the  arrow in the **Machine Safe Z** area to hide the **Safe Z** box and the **Home Position's X, Y and Z** boxes.

- Click on the **Add** button in the **Tools List** area to display the **Tool Groups Database**:

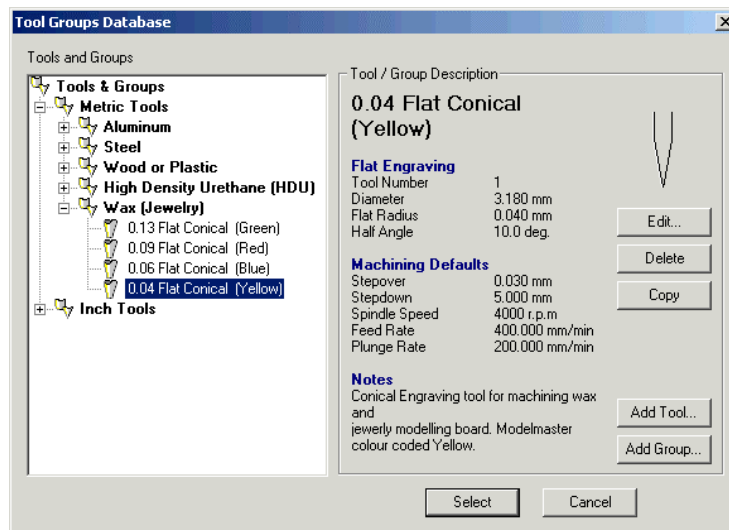

- Double-click on the Roughing or Engraving tool you want to use. ArtCAM Pro closes the **Tool Groups Database**, highlights the selected tool in the **Tools List** window and displays its details below.

If you want to amend the machining parameters of the selected tool, see "Adjusting Machining Parameters When Creating a Toolpath" on page 540.

When you have finished, click on the  arrow next to the tool's description to hide its machining parameters.

- If you want to leave extra material around the vector object, define the distance between the boundary of the selected vector object and the Roughing or Engraving tool in the **Allowance** box.
- Select how you want the tool to clear the area using the **Tool Clearance Strategy** radio buttons :
  - Raster** – This strategy machines back and forth along the X-axis at a specified angle. If you select this strategy, type the angle you want the tool to move at in the **Raster Angle** box.



---

**Note:** You can set the default raster angle using the **ArtCAM Options** page. For details, see "Managing ArtCAM Pro's Preferences" in the ArtCAM Pro Layout chapter.

---

- **Offset** – This strategy machines in repeated passes, each time moving inwards by the **Stepover** value of the tool you use.



---

**Note:** You can see the stepover value of the selected tool when the machining parameters are displayed in the **Tools List** area.

---

- If you have selected this strategy, set the cutting direction by selecting one of the **Cut Direction** radio buttons , either **Climb Mill** or **Conventional**.

In Climb Milling, the cutter rotates in the same direction as the feed motion. In Conventional Milling, the cutting tool rotates in the opposite direction to the feed motion. For more details, see "Overview" on page 403.

15. You can also control the movements of the selected Roughing or Engraving tools:

- If you want the Engraving tool to sharpen the corners of the vector object during the machining process, click to select the **Do Corner Sharpening** option .



---

**Warning:** You cannot use the **Do Corner Sharpening** option in an Engraving toolpath without using a 3-axis machine. For further information, consult a member of staff or your machine tool supplier.

---



---

**Note:** If you have not selected an Engraving tool, the **Do Corner Sharpening** option is greyed out.

---

In the example below, you can see that the tool profiles the vector text *A* to sharpen its corners when the **Do Corner Sharpening** option is selected .



*Do Corner Sharpening OFF...*

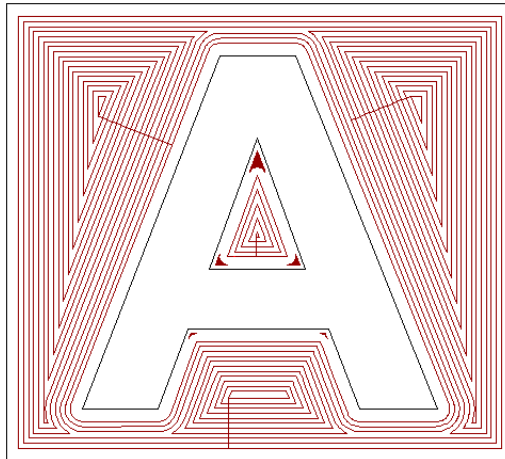

*Do Corner Sharpening ON...*

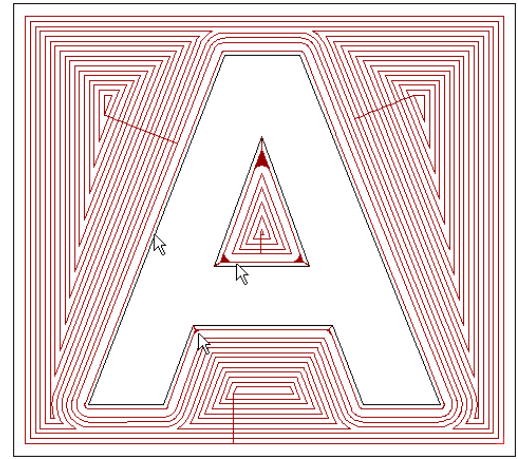

The Engraving tool is also lifted in the Z direction to minimise the curvature in the corners of the vector text *A*.

- If you want the Engraving tool to profile only the vector objects which have not already been machined with a larger tool, click to select the **Only Smart Engrave Profile** option .



---

**Note:** If you have not selected an Engraving tool, the **Only Smart Engrave Profile** option is greyed out.

---

- If you want a tool to make a single profile pass around the vector object, click to select the **Profile Only** option .

In the example below, you can see that the number of machining passes is reduced, particularly in the central cavity of the vector text *A*, when the **Profile Only** option is selected .

*Profile Only OFF...*

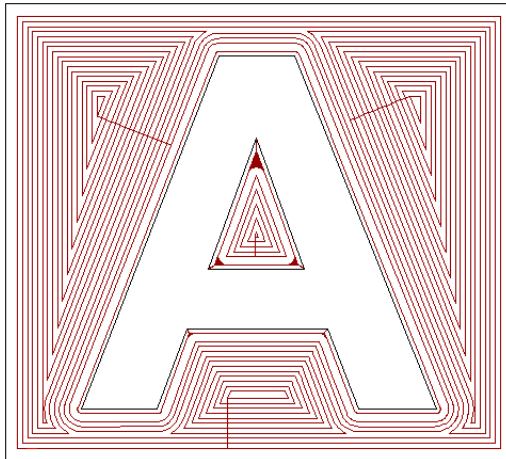

*Profile Only ON...*

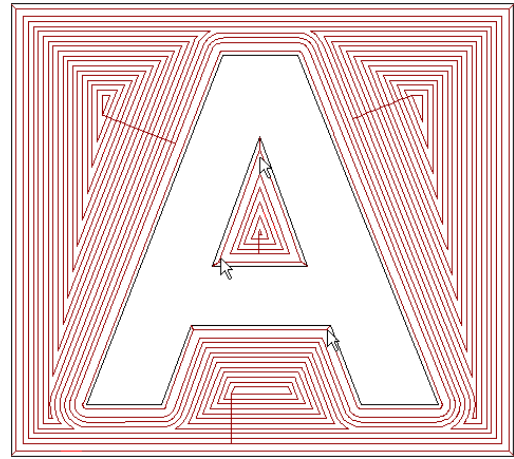

- If you want the selected tool to cut to a different depth than the other tools, click to select the **Independent Finish Depth** option , and then define the absolute Z zero value of the bottom of the area you want to engrave in the **Finish Depth** box below.

You can add as many tools as are needed for the job, setting the machining parameters and strategy for each tool after selecting it in the **Tools List** window.

16. In the **Material** area, click on the **Setup** button to display the **Material Setup** dialog box.

Make sure that the thickness of the block, the material Z zero position and the position of the model in the block is correct, then click on the **OK** button. If you want to change any of these settings, see "Adjusting the Material Setup" on page 562.

17. If you do not want to preview the toolpath in the **2D View** window, click to deselect the **Create 2D Preview** option .



---

**Tip:** It is recommended that you create a 2D preview. You can always hide it from view by clicking on the **2D** option in the **Show in** area of the **Toolpaths** Home page.

---

18. Type a name for the toolpath in the **Name** box.
19. You can now specify when you want to calculate the toolpath:

- If you want to calculate the toolpath now, click on the **Now** button.

The toolpath preview is not shown if the **Create 2D Preview** option is deselected .

You can now simulate the toolpath. For details, see "Simulating Toolpaths" on page 567.

- If you want to calculate the toolpath at a later time, click on the **Later** button. See "Calculating a Single Toolpath" on page 548 and "Calculating a Batch of Toolpaths" on page 549 for details.

20. Click on the **Close** button to return to the **Toolpaths** Home page.

## Machine Vectors





The **Machine Along Vector** button  in the **2D Toolpaths** area of the **Toolpaths** Home page allows you to machine along the boundary of a vector object.

The boundary of a selected vector object represents the centreline of the Profiling tool. The machined feature has no diameter other than that of the tip of the Profiling tool.

This toolpath is mainly used to produce the effect of engraved text or to provide sharp profiling for detailed edges.

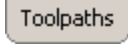
To machine a vector object:

1. Click on the **Toolpaths** tab  to display the **Toolpaths** Home page.
2. Select the vector object that you want to machine. For details, see "Selecting Vectors" in the Working with Vectors chapter.
3. Click on the **Machine Along Vector** button  in the **2D Toolpaths** area of the **Toolpaths** Home page to display the **Machine Vectors** page.
4. Define the depth (Z) from the material surface at which you want to begin machining in the **Start Depth** box.

5. Define the depth (Z) of the bottom of the cut in the **Finish Depth** box.
6. Define how closely you want the Profiling tool to follow the shape of the vector object in the **Tolerance** box
7. If you want to change the height at which the Profiling tool makes rapid moves between toolpath segments:

- First, click on the  arrow in the **Machine Safe Z** area to display the **Safe Z** box and the **Home Position's X, Y and Z** boxes.
- Next, define the height in the **Safe Z** box.

If you want to define the **Home Position** for the machining tool:

- First, define the X, Y and Z co-ordinates of the home position in the **Home Position's X, Y and Z** boxes.
- Next, click on the  arrow in the **Machine Safe Z** area to hide the **Safe Z** box and the **Home Position's X, Y and Z** boxes.

8. In the **Profiling Tool** area, click on the **Select** button to open the **Tool Groups Database**:

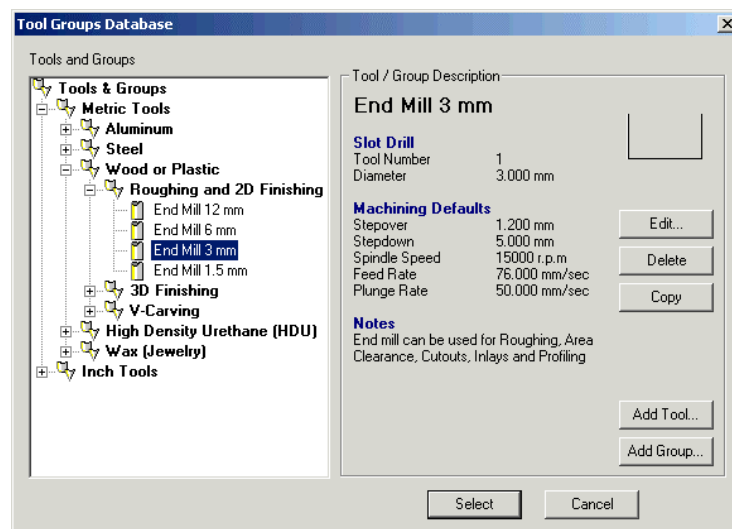

9. Double-click on the tool you want to use. ArtCAM Pro closes the **Tool Groups Database**, and displays the selected tool's description in the **Profiling Tool** area.

If you want to amend the machining parameters for the selected tool, click on the  arrow in the **Profiling Tool** area. For further information, see "Adjusting Machining Parameters When Creating a Toolpath" on page 540.

When you have finished, click on the  arrow to hide the machining parameters.

10. To add ramping moves to the toolpath, click to select the **Add Ramping Moves** option . For more details, see "Overview" on page 403.

All of the ramping move settings are selected by default . If you do not want to use any of these settings, click to deselect each of those you do not want to use . The boxes for the deselected options are greyed-out.

You can use the ramping move settings as follows:

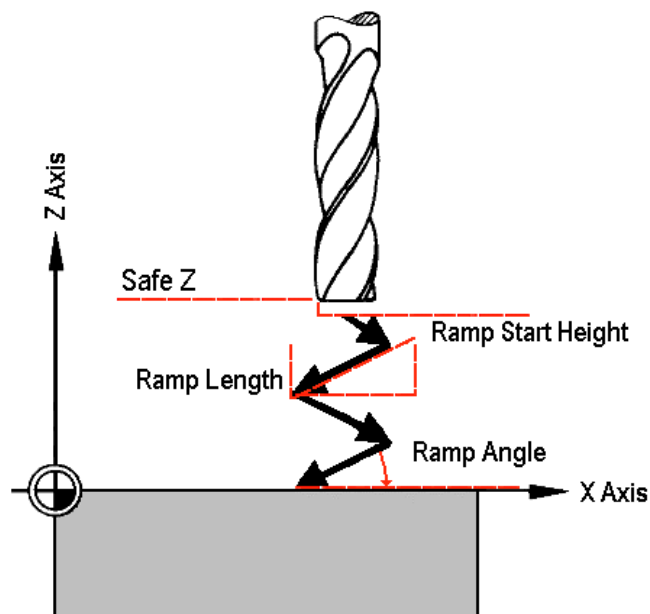

- Define the maximum angle of descent for each zig and zag movement of the cutting tool in the **Max Ramp Angle (A)** box.
- Define the maximum distance that you want the cutting tool to zigzag across the material surface in the **Max Ramp Length (L)** box.
- Define the minimum distance that you want the tool to zigzag across the material surface in the **Min Ramp Length (Lmin)** box.
- If you want to set the height at which the ramping moves start, click to select the **Ramp Start Height (S)** option , and then define the start height in the box beneath. If you do not define the **Ramp Start Height (S)** here, the **Safe Z** level is used by default.

11. From the **Sequencing** area, you can set the order in which each segment in the toolpath is machined. You can either allow ArtCAM Pro to calculate the machining order, or use a polyline drawn to indicate the machining order.

If you want to ArtCAM Pro to calculate the order in which each segment in the toolpath is machined:

- First, click on the **Auto** radio button .
- Next, click on the list box and then on the option that you want to use for the machining order:

**Optimise** – Click on this option to instruct ArtCAM Pro to find the most efficient machining order.

**Use Text Order** – Click on this option to instruct ArtCAM Pro to machine according to the order in which the selected vector text was created. The cutting tool moves along the first line of text from left to right, until it locates a carriage return when it continues machining along the next line from right to left. This process is repeated until the last character in the last line of text is located.

**Left To Right** – Click on this option to instruct ArtCAM Pro to machine from the left of the model to the right.

**Right To Left** – Click on this option to instruct ArtCAM Pro to machine from the right of the model to the left.

**Bottom To Top** – Click on this option to instruct ArtCAM Pro to machine from the bottom of the model to its top.

**Top To Bottom** – Click on this option to instruct ArtCAM Pro to machine from the top of the model to the bottom.

**Spiral Out** – Click on this option to instruct ArtCAM Pro to machine from the centre of the model outwards in a spiral motion. This is particularly useful if you are using clamps to secure the material on your router.

**Spiral In** – Click on this option to instruct ArtCAM Pro to machine from the outside edge of the model inwards in a spiral motion.

If you want to manually set the order in which each segment in the toolpath is machined:

- First, click on the **Manual** radio button .
- Next, draw a polyline in the **2D View** indicating the order in which you want the toolpath segments to be machined. Its Start Point should be positioned close to the toolpath segment from which you want to begin machining. For details, see "Creating a Polyline" in the Working with Vectors chapter.
- Next, click to select the polyline that you want to use, and then click on the **Select Vector** button. The *No Vector Selected* message in red text changes to *Vector Selected* in blue text.

If you do not select an open, ungrouped vector object, the following message box appears:

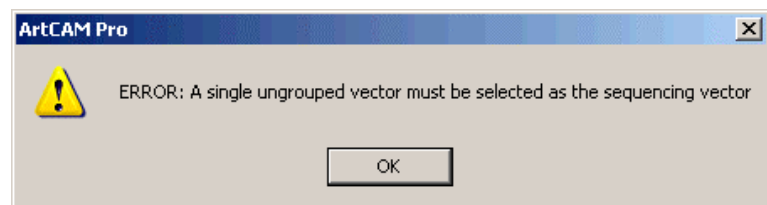

Click on the **OK** button to close the message box, and then repeat this step.

If you want to change the polyline you have selected, click on the **Cancel Selection** button and then repeat this step.

- Finally, make sure that the vector object(s) along which you want to machine are selected. For details, see "Selecting Vectors" in the Working with Vectors chapter.

12. In the **Material** area, click on the **Setup** button to display the **Material Setup** dialog box.

Make sure that the thickness of the block, the material Z zero position and the position of the model in the block is correct, then click on the **OK** button. If you want to change any of these settings, see "Adjusting the Material Setup" on page 562.

13. If you do not want to preview the toolpath in the **2D View** window, click to deselect the **Create 2D Preview** option .



---

**Tip:** It is recommended that you create a 2D preview. You can always hide it from view by clicking on the **2D** option in the **Show in** area of the **Toolpaths** Home page.

---

14. Type a name for the toolpath in the **Name** box.
15. You can now specify when you want to calculate the toolpath:
  - If you want to calculate the toolpath now, click on the **Now** button.

The **Offsetting Contours** dialog box is displayed while ArtCAM Pro calculates the toolpath:

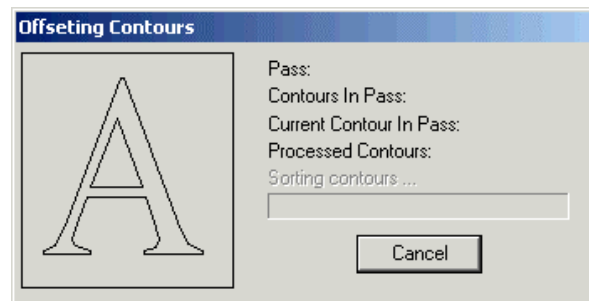

The passes used to machine the vector object are represented by dark red lines drawn on the boundary of the selected vector object:

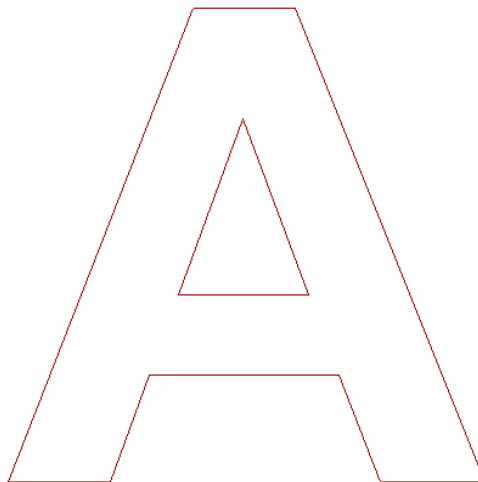

A circle marking the current start position is drawn on the toolpath preview. For details, see "Changing the Start Position" on page 533.

The toolpath preview is not shown if the **Create 2D Preview** option is deselected .

You can now simulate the toolpath. For details, see "Simulating Toolpaths" on page 567.



- If you want to calculate the toolpath at a later time, click on the **Later** button. For details, see "Calculating a Single Toolpath" on page 548 and "Calculating a Batch of Toolpaths" on page 549.

16. Click on the **Close** button to return to the **Toolpaths** Home page.

If you want to add bridges to, add lead moves to, or change the start position in any of the profile passes in the Machine Vectors toolpath, see "Editing a Profile Pass" on page 527.

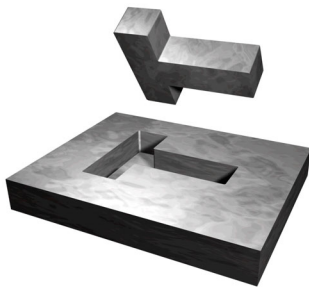

If you want to set the machining order of the profile passes in the Machine Vectors toolpath, see "Setting the Machining Order" on page 537.

## Inlay Wizard



The **Inlay Wizard** button  in the **2D Toolpaths** area of the **Toolpaths** Home page allows you to create a toolpath that can produce one of many different kinds of inlays and inserts. Essentially, you can use this toolpath to machine interlocking male and female parts. ArtCAM Pro allows these interlocking parts to fit perfectly by adjusting the shape of the corners according to the tool that is used to machine them.

To produce a particular style of interlocking male and female parts:

1. Click on the **Toolpaths** tab  to display the **Toolpaths** Home page.
2. Select the vector object from which you want to create an inlay or an insert. For details, see "Selecting Vectors" in the Working with Vectors chapter.
3. Click on the **Inlay Wizard** button  in the **2D Toolpaths** area of the **Toolpaths** Home page to display the **Inlay Wizard** page.
4. Select the **Inlay Type** that you want to create:
  - **Pocket**. For details, see "Creating a Pocket" on page 448.
  - **Hole**. For details, see "Creating a Hole" on page 454.

- **Stepped Pocket.** For details, see "Creating a Stepped Pocket" on page 458.
- **Stepped Hole.** For details, see "Creating a Stepped Hole" on page 465.
- **Straight Insert.** For details, see "Creating a Straight Insert" on page 469.
- **Stepped Insert.** For details, see "Creating a Stepped Insert" on page 474.

## Creating a Pocket

This **Female Inlay** option displays the **Female Inlay Pocket** page in the **Assistant** window. This allows you to create a pocket, which is a hole in the material that has a bottom and does not go right through the block. You can then create a male straight insert to fit into the pocket.

Using the **Female Inlay Pocket** page, you can:

- Select both Roughing and Finishing tools.
- Select a tool clearance strategy for the Finishing or Roughing tool you want to use. Depending on the strategy you select, you can control the angle, where and in what direction the tool cuts into the block of material.
- Control how the Roughing and/or Finishing tools cut into and retract from the block of material by adding ramping moves.

To create a pocket:

1. Click on the **Pocket** option  in the **Inlay Types** area of the **Inlay Wizard** page. ArtCAM Pro displays the **Female Inlay Pocket** page in the **Assistant** window.
2. Define the depth (Z) from the material surface at which you want to create the pocket in the **Start Depth** box.
3. Define the depth (Z) of the bottom of the pocket in the **Finish Depth** box.
4. If you want to enlarge or reduce the pocket around the selected vector object, define the distance between the boundary of the selected vector object and the cutting tool(s) in the **Allowance** box. Type a positive value to add material or a negative value to remove it.

Make sure that there is a sufficient allowance for the corresponding male straight insert to fit into the pocket.

5. Define how closely you want the cutting tool(s) to follow the shape of the vector object in the **Tolerance** box.
6. If you want to change the height at which a cutting tool makes rapid moves between toolpath segments:
  - First, click on the  arrow in the **Machine Safe Z** area to display the **Safe Z** box and the **Home Position's X, Y and Z** boxes.
  - Next, define the height in the **Safe Z** box.

If you want to define the **Home Position** for the machining tool:

- First, define the X, Y and Z co-ordinates of the home position in the **Home Position's X, Y and Z** boxes.
  - Next, click on the  arrow in the **Machine Safe Z** area to hide the **Safe Z** box and the **Home Position's X, Y and Z** boxes.
7. Click on the **Select** button in the **Finishing Tool** area of the page to open the **Tool Groups Database**:
  8. Double-click on the tool you want to use. ArtCAM Pro closes the **Tool Groups Database** and displays the selected tool's description in the **Finishing Tool** area.



---

**Important:** The selected **Finishing Tool** must be the same size as the tool used to machine the male straight insert you want to fit into this pocket.

---

If you want to amend the machining parameters for the selected tool, click on the  arrow in the **Finishing Tool** area. For further information, see "Adjusting Machining Parameters When Creating a Toolpath" on page 540.

When you have finished, click on the  arrow to hide the machining parameters.

9. Select whether you want to use a Roughing tool or not:
10. If you want to enlarge or reduce the pocket around the selected vector object, define the distance between the boundary of the selected vector object and the Finishing tool in the **Allowance** box. Type a positive value to add material or a negative value to remove it.

11. Select how you want the tool to clear the pocket using the **Strategy** radio buttons :



---

**Important:** If you are using a Roughing tool, the strategy that you select applies to the selected tool and an **Offset** strategy with a **Climb Mill** cut direction is applied by default to the Finishing tool. If you are not using a Roughing tool, the strategy that you select applies to the Finishing tool.

---

- **Raster** - This strategy machines in passes back and forth along the X-axis at a specified angle. If you select this strategy, define the angle you want the tool to move at in the **Raster Angle** box.



---

**Note:** You can set the default raster angle using the **ArtCAM Options** page. For details, see "Managing ArtCAM Pro's Preferences" in the ArtCAM Pro Layout chapter.

---

Next, click on one of the **Profile Pass** radio buttons :

**None** – Select this option if you do not want the tool to profile the selected vector object.

**First** – Select this option if you want the tool to profile the selected vector object first and then raster clear the area.

**Last** – Select this option if you want the tool to move outwards to raster clear the area, then profile the selected vector object.

- **Offset** - This strategy machines in repeated passes, each time moving inwards by the **Stepover** value of the tool you use.



---

**Note:** You can see the stepover value of the selected tool when the machining parameters are displayed in the **Roughing Tool** and/or **Finishing Tool** areas.

---

*Raster Strategy at 45°...*

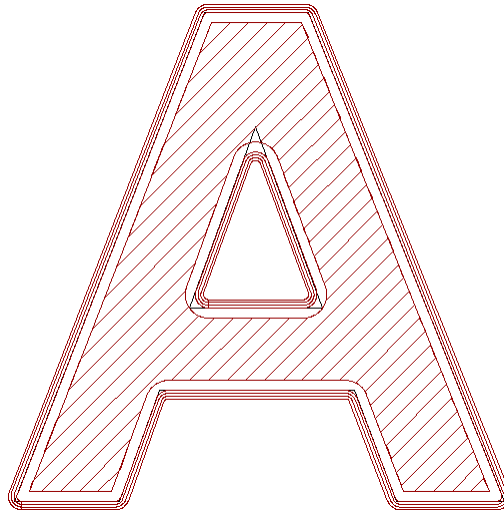

*Offset Strategy at Climb...*

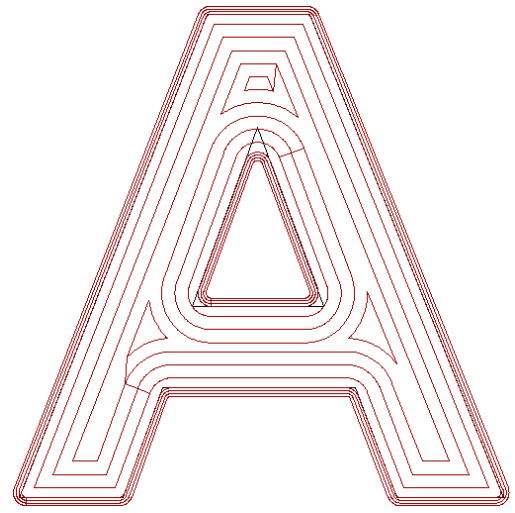

If you select **Offset**, click on one of the **Cut Direction** radio buttons :

**Climb Mill** – In Climb Milling, the cutter rotates in the same direction as the feed motion.



---

**Note:** You can set the default cutting direction in ArtCAM Pro using the **ArtCAM Options** page. For details, see "Managing ArtCAM Pro's Preferences" in the ArtCAM Pro Layout chapter.

---

**Conv.** – In Conventional Milling, the cutter rotates in the opposite direction to the feed motion. For more details, see "Overview" on page 403.

Next, click on one of the **Start Point** radio buttons :

**Outside** - Select this option if you want the tool to cut into the material at the vector object's boundary, then machine inwards.

**Inside** - Select this option if you want the tool to cut into the material at the vector object's centre, then machine outwards.

12. When you have set a tool clearance strategy, you can choose whether or not to add ramping moves to the machining passes made by the cutting tools:

- If you want to add ramping moves to the toolpath, click to select the **Add Ramping Moves** option . For more details, see "Overview" on page 403.

All of the ramping move settings are selected by default . If you do not want to use any of these settings, click to deselect each of those you do not require . The boxes for the deselected options are greyed-out.

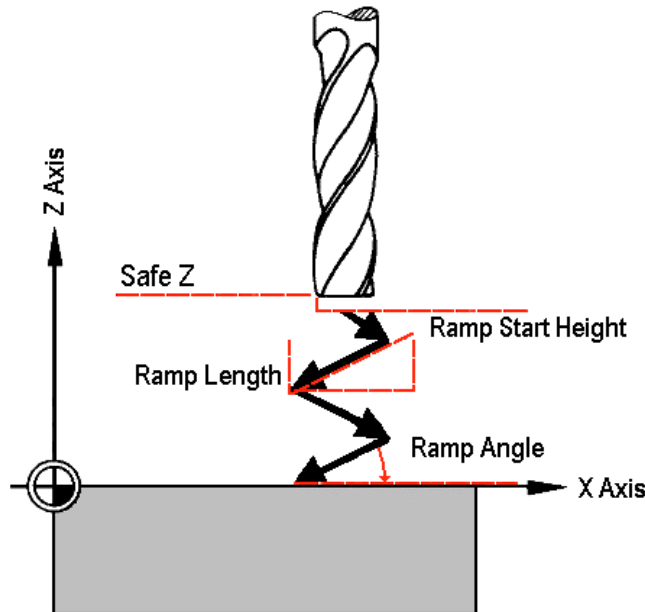

- Define the maximum angle of descent for each zig and zag movement of the cutting tool in the **Max Ramp Angle (A)** box.
  - Define the maximum distance that you want the cutting tool to zigzag across the material surface in the **Max Ramp Length (L)** box.
  - Define the minimum distance that you want the tool to zigzag across the material surface in the **Min Ramp Length (Lmin)** box.
  - If you want to set the height at which the ramping moves start, click to select the **Ramp Start Height (S)** option , and then define the start height in the box beneath. If you do not define the **Ramp Start Height (S)** here, the **Safe Z** level is used by default.
13. In the **Material** area, click on the **Setup** button to display the **Material Setup** dialog box.

Make sure that the thickness of the block, the material Z zero position and the position of the model in the block is correct, then click on the **OK** button. If you want to change

any of these settings, see "Adjusting the Material Setup" on page 562.

14. If you do not want to preview the toolpath in the **2D View** window, click to deselect the **Create 2D Preview** option .



---

**Tip:** It is recommended that you create a 2D preview. You can always hide it from view by clicking on the **2D** option in the **Show in** area of the **Toolpaths** Home page.

---

15. Type a name for the toolpath in the **Name** box.
16. You can now specify when you want to calculate the toolpath:
  - If you want to calculate the toolpath now, click on the **Now** button.

The **Offsetting Contours** dialog box is displayed while ArtCAM Pro calculates the toolpath:

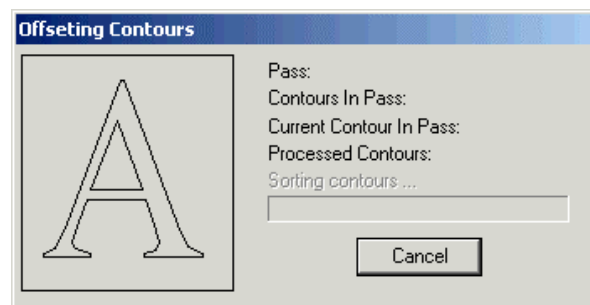

The passes used to machine the pocket are represented by dark red lines drawn along the boundary and inside of the selected vector object, according to the **Strategy** selected.

The toolpath preview is not shown if the **Create 2D Preview** option is deselected .

You can now simulate the toolpath. For details, see "Simulating Toolpaths" on page 567.

- If you want to calculate the toolpath at a later time, click on the **Later** button. For details, see "Calculating a Single Toolpath" on page 548 and "Calculating a Batch of Toolpaths" on page 549.
17. Click on the **Close** button to return to the **Toolpaths** Home page.

## Creating a Hole

This **Female Inlay** option displays the **Female Inlay** page in the **Assistant** window. This allows you to create a hole in the block of material. You can then create a male straight insert to fit into the hole.

Using the **Female Inlay** page, you can:

- Select a tool to cut the hole in the block of material.
- Control the cutting direction of the tool.

To create a hole:

1. Click on the **Hole** option  in the **Inlay Types** area of the **Inlay Wizard** page to display the **Female Inlay** page in the **Assistant** window.
2. Define the depth (Z) from the material surface at which you want to create the hole in the **Start Depth** box.
3. Define the depth (Z) for the bottom of the hole in the **Finish Depth** box.
4. If you want to enlarge or reduce the hole around the selected vector object, define the distance between the boundary of the selected vector object and the cutting tool in the **Allowance** box. Type a positive value to enlarge the hole or a negative value to reduce it.

Make sure that there is a sufficient allowance for the corresponding male straight insert to fit into the hole.

5. Define how closely you want the cutting tool to follow the shape of the vector object in the **Tolerance** box.
6. If you want to change the height at which the cutting tool makes rapid moves between toolpath segments:
  - First, click on the  arrow in the **Machine Safe Z** area to display the **Safe Z** box and the **Home Position's X, Y and Z** boxes.
  - Next, define the height in the **Safe Z** box.

If you want to define the **Home Position** for the machining tool:

- First, define the X, Y and Z co-ordinates of the home position in the **Home Position's X, Y and Z** boxes.



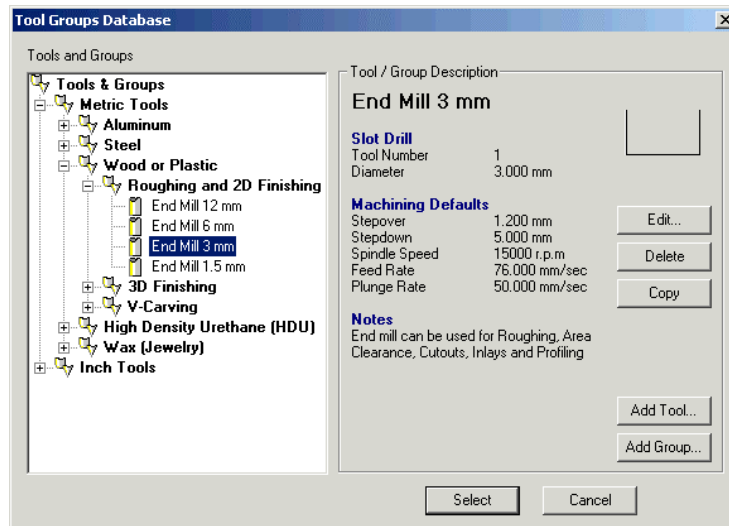

- Next, click on the  arrow in the **Machine Safe Z** area to hide the **Safe Z** box and the **Home Position's X, Y and Z** boxes.

7. Click on the **Select** button in the **Tool** area of the page to display the **Tool Groups Database**:



8. Double-click on the tool you want to use. ArtCAM Pro closes the **Tool Groups Database** and displays the selected tool's description in the **Tool** area.

9. To set the cut direction, click on the  arrow in the **Cut Direction** area of the page, and then click on one of the **Cut Direction** radio buttons :

- **Climb Mill** – In Climb Milling, the cutter rotates in the same direction as the feed motion.
- **Conventional** – In Conventional Milling, the cutter rotates in the opposite direction to the feed motion. For more details, see "Overview" on page 403.





---

**Note:** You can set the default cutting direction in ArtCAM Pro using the **ArtCAM Options** page. For details, see "Managing ArtCAM Pro's Preferences" in the ArtCAM Pro Layout chapter.

---

10. To add ramping moves to the toolpath, click to select the **Add Ramping Moves** option . For more details, see "Overview" on page 403.

All of the ramping move settings are selected by default . If you do not want to use any of these settings, click to deselect each of those you do not want to use . The boxes for the deselected options are greyed-out.

You can use the ramping move settings as follows:

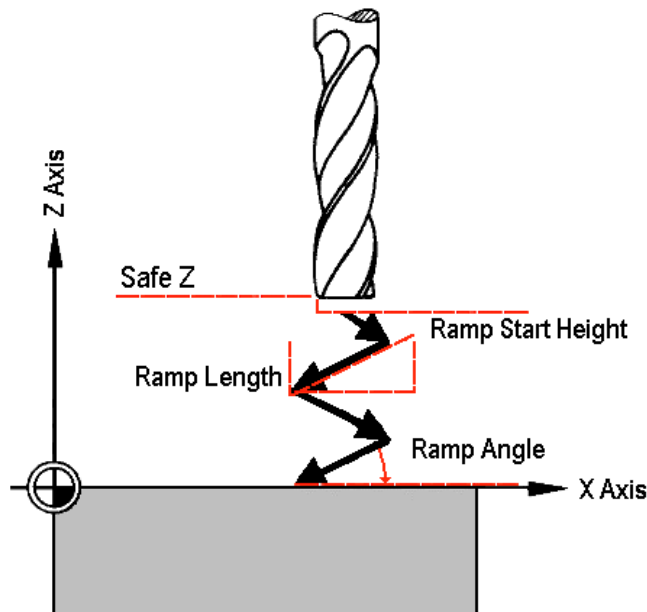

- Define the maximum angle of descent for each zig and zag movement of the cutting tool in the **Max Ramp Angle (A)** box.
  - Define the maximum distance that you want the cutting tool to zigzag across the material surface in the **Max Ramp Length (L)** box.
  - Define the minimum distance that you want the tool to zigzag across the material surface in the **Min Ramp Length (Lmin)** box.
  - If you want to set the height at which the ramping moves start, click to select the **Ramp Start Height (S)** option , and then define the start height in the box beneath. If you do not define the **Ramp Start Height (S)** here, the **Safe Z** level is used by default.
11. In the **Material** area, click on the **Setup** button to display the **Material Setup** dialog box.

Make sure that the thickness of the block, the material Z zero position and the position of the model in the block is correct, then click on the **OK** button. If you want to change any of these settings, see "Adjusting the Material Setup" on page 562.

12. If you do not want to preview the toolpath in the **2D View** window, click to deselect the **Create 2D Preview** option .



---

**Tip:** It is recommended that you create a 2D preview. You can always hide it from view by clicking on the **2D** option in the **Show in** area of the **Toolpaths** Home page.

---

13. Type a name for the toolpath in the **Name** box.
14. You can now specify when you want to calculate the toolpath:
- If you want to calculate the toolpath now, click on the **Now** button.

The **Offsetting Contours** dialog box is displayed while ArtCAM Pro calculates the toolpath:

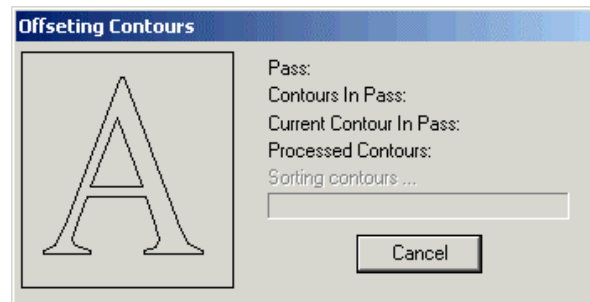

The passes used to machine the hole are represented by dark red lines drawn around the boundary of the selected vector object:

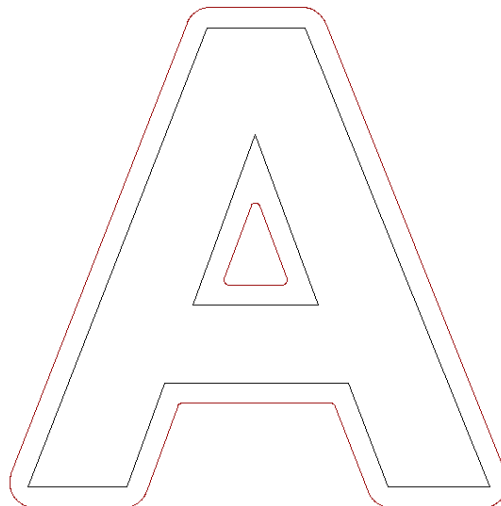

The toolpath preview is not shown if the **Create 2D Preview** option is deselected .

You can now simulate the toolpath. For details, see "Simulating Toolpaths" on page 567.

- If you want to calculate the toolpath at a later time, click on the **Later** button. If you have chosen to calculate the toolpath later, see "Calculating a Single Toolpath" on page 548 and "Calculating a Batch of Toolpaths" on page 549.

15. Click on the **Close** button to return to the **Toolpaths** Home page.

If you want to add bridges to, add lead moves to, or change the start position in any of the profile passes in the Female Inlay toolpath, see "Editing a Profile Pass" on page 527.

If you want to set the machining order of the profile passes in the Female Inlay toolpath, see "Setting the Machining Order" on page 537.

## ***Creating a Stepped Pocket***

This **Female Inlay** option displays the **Female Stepped Pocket Inlay** page in the **Assistant** window. This allows you to create a stepped pocket, which is a stepped hole in the material that has a bottom and does not go right through the block. You can then create a male stepped insert to fit into the stepped pocket.

Using the **Female Stepped Pocket Inlay** page, you can:

- Select both Roughing and Finishing tools.
- Select a tool clearance strategy for the Finishing or Roughing tool you want to use.

Depending on the strategy you select, you can control the angle, where and in what direction the tool cuts into the block of material.

- Control how the Roughing and/or Finishing tools cut into and retract from the block of material by adding ramping moves.

To create a stepped pocket:

1. Click on the **Stepped Pocket** option  in the **Inlay Types** area of the **Inlay Wizard** page to display the **Female Stepped Pocket Inlay** page in the **Assistant** window.

2. Define the depth (Z) from the material surface at which you want to create the stepped pocket in the **Start Depth** box.
3. Define the depth (Z) of the bottom of the stepped pocket in the **Finish Depth** box.
4. If you want to enlarge or reduce the stepped pocket around the selected vector object, define the distance between the boundary of the selected vector object and the cutting tool(s) in the **Allowance** box. Type a positive value to add material or a negative value to remove it.

Make sure that there is a sufficient allowance for the corresponding male stepped insert to fit into the stepped pocket.

5. Define how closely you want the cutting tool(s) to follow the shape of the vector object in the **Tolerance** box.
6. If you want to change the height at which the cutting tools used make rapid moves between toolpath segments:

- First, click on the  arrow in the **Machine Safe Z** area to display the **Safe Z** box and the **Home Position's X, Y and Z** boxes.
- Next, define the height in the **Safe Z** box.

If you want to define the **Home Position** for the machining tools used:

- First, define the X, Y and Z co-ordinates of the home position in the **Home Position's X, Y and Z** boxes.
- Next, click on the  arrow in the **Machine Safe Z** area to hide the **Safe Z** box and the **Home Position's X, Y and Z** boxes.

7. In the **Shoulder Dimensions** area, define the relative depth of the shoulder from the **Start Depth** in the **Depth (d)** box.
8. Define the width of the shoulder in the **Width (s)** box.
9. In the **Finishing Tool** area, click on the **Select** button to open the **Tool Groups Database**:

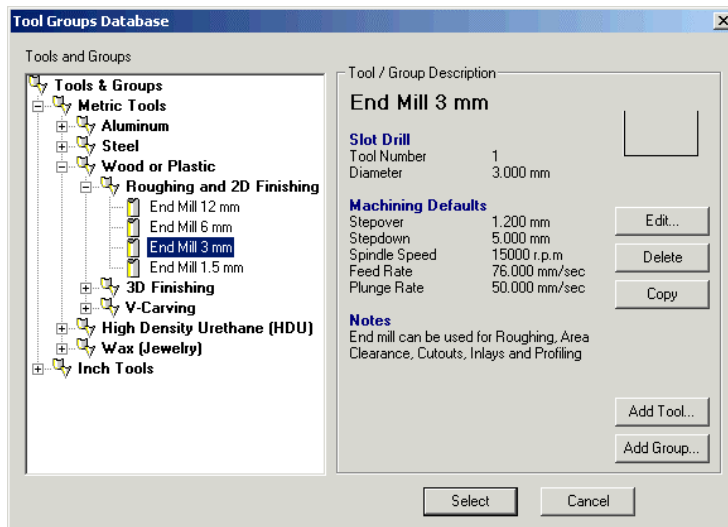

10. Double-click on the tool you want to use. ArtCAM Pro closes the **Tool Groups Database** and displays the selected tool's description in the **Finishing Tool** area.



---

**Note:** The selected **Finishing Tool** must be the same size as the tool used to machine the male stepped insert which you want to fit into this stepped pocket.

---

11. Select whether you want to use a Roughing tool or not:
  - If you want to use the Finishing tool you have already selected to create the whole pocket, make sure that the **Use Roughing Tool** option is deselected , and then go straight to the next step.
  - If you want to use a Roughing tool to create the pocket, click to select the **Use Roughing Tool** option .

In the **Roughing Tool** area, which is now displayed, click on the **Select** button to open the **Tool Groups Database** again.

Double-click on the tool you want to use. Its description is displayed in the **Roughing Tool** area.

If you want to amend the machining parameters for the selected tool, click on the  arrow in the **Roughing Tool** area. For further information, see "Adjusting Machining Parameters When Creating a Toolpath" on page 540.

When you have finished, click on the  arrow to hide the machining parameters.

12. If you want the Finishing tool to enlarge or reduce the stepped pocket around the selected vector object, define the distance between the boundary of the selected vector object and the Finishing tool in the **Allowance** box. Type a positive value to enlarge the stepped pocket or a negative value to reduce it.
13. Select how you want the tool to clear the pocket using the **Strategy** radio buttons 



---

**Important:** If you are using a Roughing tool, the strategy that you select applies to the selected tool and an **Offset** strategy with a **Climb Mill** cut direction is applied by default to the Finishing tool. If you are not using a Roughing tool, the strategy that you select applies to the Finishing tool.

---

- **Raster** - This strategy machines in passes back and forth along the X-axis at a specified angle. If you select this strategy, first define the angle at which you want the tool to move in the **Raster Angle** box.



---

**Note:** You can set the default raster angle using the **ArtCAM Options** page. For details, see "Managing ArtCAM Pro's Preferences" in the ArtCAM Pro Layout chapter.

---

Next, click on one of the **Profile Pass** radio buttons 

**None** – Select this option if you do not want the tool to profile the selected vector object.

**First** – Select this option if you want the tool to profile the selected vector object first and then raster clear the area.

**Last** – Select this option if you want the tool to move outwards to raster clear the area, then profile the selected vector object.

- **Offset** - This strategy machines in repeated passes, each time moving inwards by the **Stepover** value of the tool you use.



---

**Note:** You can see the stepover value of the selected tool when the machining parameters are displayed in the **Roughing Tool** and/or **Finishing Tool** areas.

---

*Raster Strategy at 45°...*

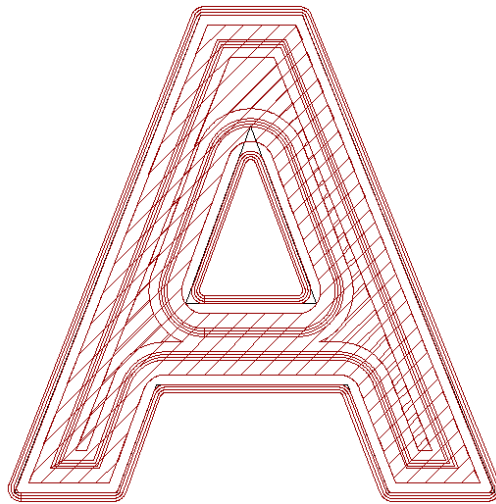

*Offset Strategy...*

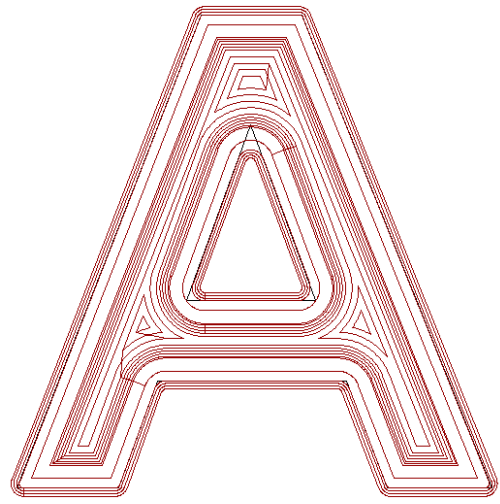

If you select **Offset**, click on one of the **Cut Direction** radio buttons :

**Climb Mill** – In Climb Milling, the cutter rotates in the same direction as the feed motion.

**Conv.** – In Conventional Milling, the cutter rotates in the opposite direction to the feed motion. For more details, see "Overview" on page 403.



---

**Note:** You can set the default cutting direction in ArtCAM Pro using the **ArtCAM Options** page. For details, see "Managing ArtCAM Pro's Preferences" in the ArtCAM Pro Layout chapter.

---

Next, click on one of the **Start Point** radio buttons :

**Outside** - Select this option if you want the tool to cut into the material at the vector object's boundary, then machine inwards.

**Inside** - Select this option if you want the tool to cut into the material at the vector object's centre, then machine outwards.



---

**Note:** You can set the default offset start point using the **ArtCAM Options** page. For details, see "Managing ArtCAM Pro's Preferences" in the ArtCAM Pro Layout chapter.

---

14. When you have set a tool clearance strategy, you can choose whether or not to add ramping moves to the machining passes made by the cutting tool(s):



- If you want to add ramping moves to the toolpath, click to select the **Add Ramping Moves** option . For more details, see "Overview" on page 403.

All of the ramping move settings are selected by default . If you do not want to use any of these settings, click to deselect each of those you do not require . The boxes for the deselected options are greyed-out.

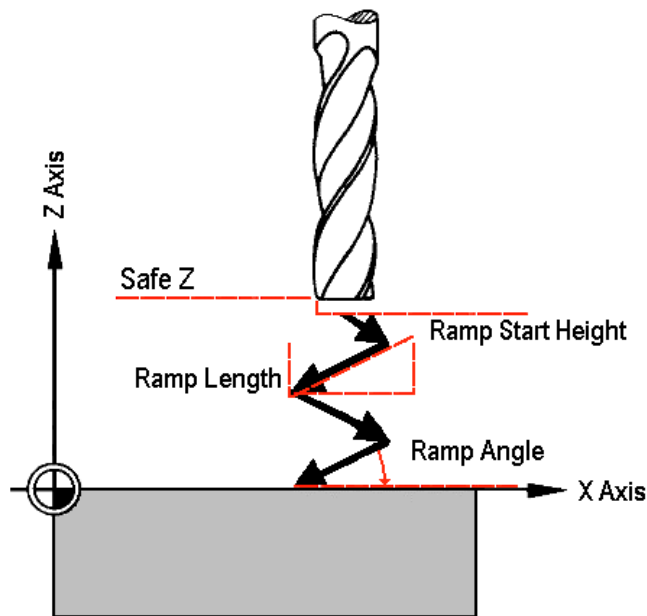

- Define the maximum angle of descent for each zig and zag movement of the cutting tool in the **Max Ramp Angle (A)** box.
- Define the maximum distance that you want the cutting tool to zigzag across the material surface in the **Max Ramp Length (L)** box.
- Define the minimum distance that you want the tool to zigzag across the material surface in the **Min Ramp Length (Lmin)** box.
- If you want to set the height at which the ramping moves start, click to select the **Ramp Start Height (S)** option , and then define the start height in the box beneath. If you do not define the **Ramp Start Height (S)** here, the **Safe Z** level is used by default.

15. In the **Material** area, click on the **Setup** button to display the **Material Setup** dialog box.

Make sure that the thickness of the block, the material Z zero position and the position of the model in the block is correct, then click on the **OK** button. If you want to change any of these settings, see "Adjusting the Material Setup" on page 562.

16. If you do not want to preview the toolpath in the **2D View** window, click to deselect the **Create 2D Preview** option .



---

**Tip:** It is recommended that you create a 2D preview. You can always hide it from view by clicking on the **2D** option in the **Show in** area of the **Toolpaths** Home page.

---

17. Type a name for the toolpath in the **Name** box.
18. You can now specify when you want to calculate the toolpath:
  - If you want to calculate the toolpath now, click on the **Now** button.

The **Offsetting Contours** dialog box is displayed while ArtCAM Pro calculates the toolpath:

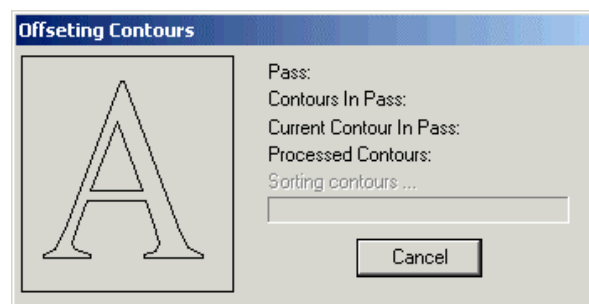

The passes used to machine the stepped pocket are represented by dark red lines drawn along the boundary and inside of the selected vector object, according to the **Strategy** selected.

The toolpath preview is not shown if the **Create 2D Preview** option is deselected .

You can now simulate the toolpath. For details, see "Simulating Toolpaths" on page 567.

- If you want to calculate the toolpath at a later time, click on the **Later** button. For details, see "Calculating a Single Toolpath" on page 548 and "Calculating a Batch of Toolpaths" on page 549.

19. Click on the **Close** button to return to the **Toolpaths** Home page.

## ***Creating a Stepped Hole***

This **Female Inlay** option displays the **Female Stepped Hole Inlay** page in the **Assistant** window. This allows you to create a stepped hole in the block of material. You can then create a male stepped insert to fit into the stepped hole.

Using the **Female Stepped Hole Inlay** page, you can:

- Control the depth and width of the hole's shoulder.
- Select a tool to cut the hole in the block of material.
- Control the cutting direction of the tool.

To create a stepped hole:

1. Click on the **Stepped Hole** option  in the **Inlay Types** area of the **Inlay Wizard** page to display the **Female Stepped Hole Inlay** page in the **Assistant** window.
2. Define the depth (Z) from the material surface at which you want to create the stepped hole in the **Start Depth** box.
3. Define the depth (Z) of the bottom of the stepped hole in the **Finish Depth** box.
4. If you want to enlarge or reduce the stepped hole around the selected vector object, define the distance between the boundary of the selected vector object and the cutting tool in the **Allowance** box. Type a positive value to enlarge the stepped hole or a negative value to reduce it.

Make sure that there is a sufficient allowance for the corresponding male stepped insert to fit into the stepped hole.

5. Define how closely you want the cutting tool to follow the shape of the vector object in the **Tolerance** box.
6. If you want to change the height at which the cutting tool makes rapid moves between toolpath segments:
  - First, click on the  arrow in the **Machine Safe Z** area to display the **Safe Z** box and the **Home Position's X, Y and Z** boxes.

- Next, define the height in the **Safe Z** box.

If you want to define the **Home Position** for the machining tools used:

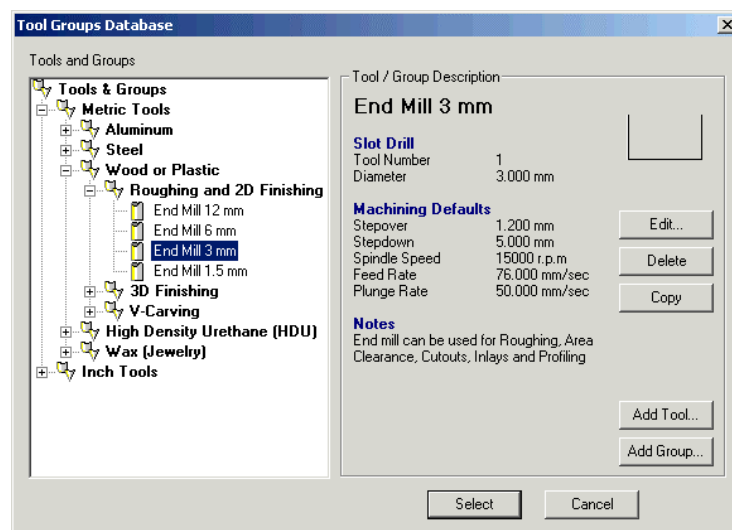

- First, define the X, Y and Z co-ordinates of the home position in the **Home Position's X, Y and Z** boxes.
  - Next, click on the  arrow in the **Machine Safe Z** area to hide the **Safe Z** box and the **Home Position's X, Y and Z** boxes.
7. In the **Shoulder Dimensions** area, define the relative depth of the shoulder from the **Start Depth** in the **Depth (d)** box.
  8. Define the width of the shoulder in the **Width (s)** box.
  9. In the **Tool** area, click on the **Select** button to display the **Tool Groups Database**:



10. Double-click on the tool you want to use. ArtCAM Pro closes the **Tool Groups Database** and displays the selected tool's description in the **Tool** area.

If you want to amend the machining parameters for the selected tool, click on the  arrow in the **Finishing Tool** area. For further information, see "Adjusting Machining Parameters When Creating a Toolpath" on page 540.

When you have finished, click on the  arrow to hide the machining parameters.

11. To set the cut direction, click on the  arrow in the **Cut Direction** area of the page, then click on one of the **Cut Direction** radio buttons :

- **Climb Mill** – In Climb Milling, the cutter rotates in the same direction as the feed motion.
- **Conventional** – In Conventional Milling, the cutter rotates in the opposite direction to the feed motion.  
For more details, see "Overview" on page 403.



---

**Note:** You can set the default cutting direction in ArtCAM Pro using the **ArtCAM Options** page. For details, see "Managing ArtCAM Pro's Preferences" in the ArtCAM Pro Layout chapter.

---

- To add ramping moves to the toolpath, click to select the **Add Ramping Moves** option . For more details, see "Overview" on page 403.

All of the ramping move settings are selected by default . If you do not want to use any of these settings, click to deselect each of those you do not want to use . The boxes for the deselected options are greyed-out.

You can use the ramping move settings as follows:

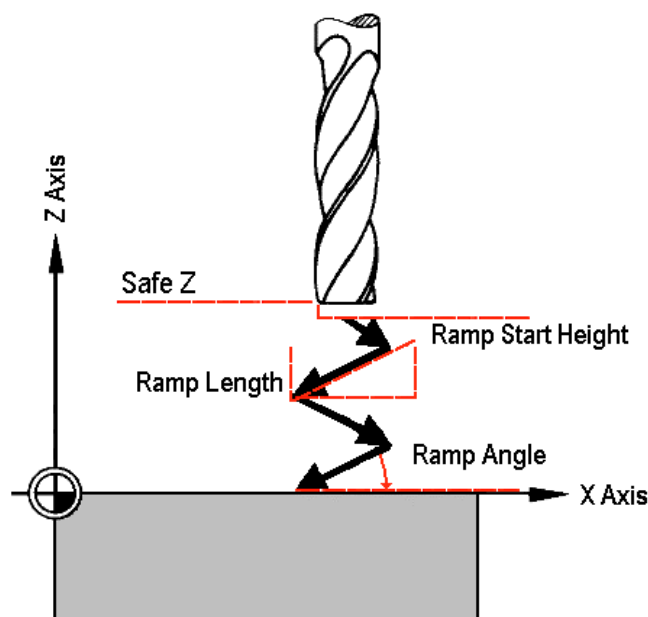

- Define the maximum angle of descent for each zig and zag movement of the cutting tool in the **Max Ramp Angle (A)** box.
- Define the maximum distance that you want the cutting tool to zigzag across the material surface in the **Max Ramp Length (L)** box.

- Define the minimum distance that you want the tool to zigzag across the material surface in the **Min Ramp Length (Lmin)** box.
  - If you want to set the height at which the ramping moves start, click to select the **Ramp Start Height (S)** option , and then define the start height in the box beneath. If you do not define the **Ramp Start Height (S)** here, the **Safe Z** level is used by default.
13. In the **Material** area, click on the **Setup** button to display the **Material Setup** dialog box.
- Make sure that the thickness of the block, the material Z zero position and the position of the model in the block is correct, then click on the **OK** button. If you want to change any of these settings, see "Adjusting the Material Setup" on page 562.
14. If you do not want to preview the toolpath in the **2D View** window, click to deselect the **Create 2D Preview** option .





---

**Tip:** It is recommended that you create a 2D preview. You can always hide it from view by clicking on the **2D** option in the **Show in** area of the **Toolpaths** Home page.

---

15. Type a name for the toolpath in the **Name** box.
16. You can now specify when you want to calculate the toolpath:
- If you want to calculate the toolpath now, click on the **Now** button.

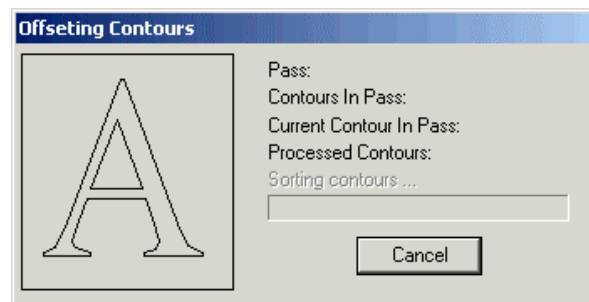
The **Offsetting Contours** dialog box is displayed while ArtCAM Pro calculates the toolpath:



The passes used to machine the stepped hole are represented by dark red lines drawn around the selected vector object's boundary:

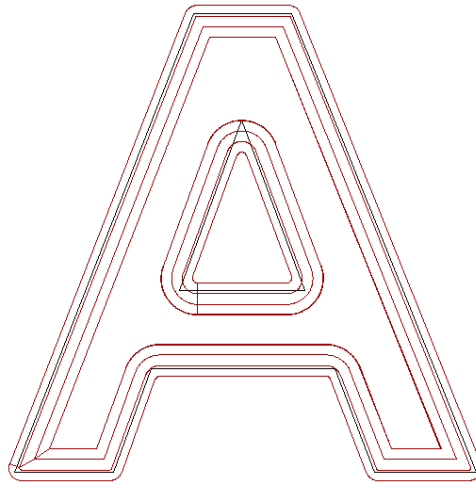

The toolpath preview is not shown if the **Create 2D Preview** option is deselected .

You can now simulate the toolpath. For details, see "Simulating Toolpaths" on page 567.

- If you want to calculate the toolpath at a later time, click on the **Later** button. For details, see "Calculating a Single Toolpath" on page 548 and "Calculating a Batch of Toolpaths" on page 549.

17. Click on the **Close** button to return to the **Toolpaths** Home page.

## ***Creating a Straight Insert***

This **Male Inlay** option displays the **Male Insert** page in the **Assistant** window. This allows you to create a male straight insert from the block of material. You can then create a female hole or pocket to fit the male straight insert into.

Using the **Male Insert** page, you can:

- Select a tool to cut the straight insert out of the block.
- Control the cutting direction of the tool.

To create a straight insert:

1. Click on the **Straight** option  in the **Inlay Types** area of the **Inlay Wizard** page to display the **Male Insert** page in the **Assistant** window.
2. Define the depth (Z) from the material surface at which you want to create the straight insert in the **Start Depth** box.

3. Define the depth (Z) of the bottom of the straight insert in the **Finish Depth** box.
4. If you want to enlarge or reduce the straight insert around the selected vector object, define the distance between the boundary of the selected vector object and the cutting tool in the **Allowance** box. Type a positive value to enlarge the stepped hole or a negative value to reduce it.

Make sure that there is a sufficient allowance for the corresponding female hole or pocket.

5. Define how closely you want the cutting tool to follow the shape of the vector object in the **Tolerance** box.
6. If you want to change the height at which the cutting tool makes rapid moves between toolpath segments:

- First, click on the  arrow in the **Machine Safe Z** area to display the **Safe Z** box and the **Home Position's X, Y and Z** boxes.
- Next, define the height in the **Safe Z** box.

If you want to define the **Home Position** for the machining tool:

- First, define the X, Y and Z co-ordinates of the home position in the **Home Position's X, Y and Z** boxes.
- Next, click on the  arrow in the **Machine Safe Z** area to hide the **Safe Z** box and the **Home Position's X, Y and Z** boxes.

7. In the **Tool** area, click on the **Select** button to display the **Tool Groups Database**:

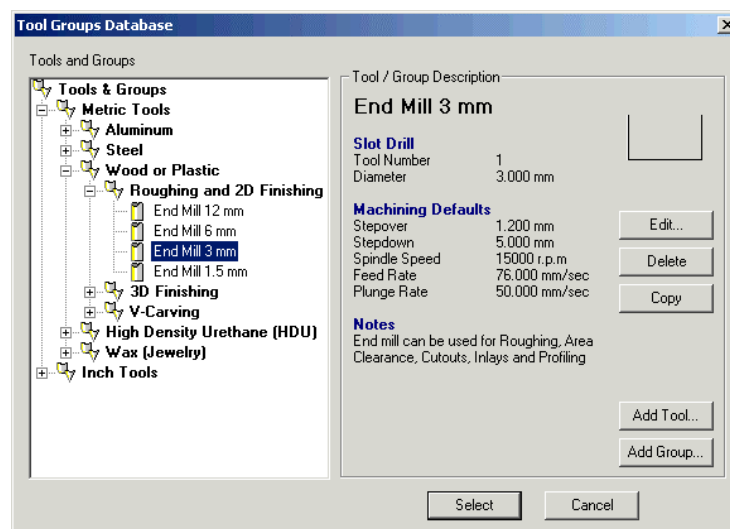



8. Double-click on the tool you want to use. ArtCAM Pro closes the **Tool Groups Database** and displays the selected tool's description in the **Tool** area.





---

**Note:** The selected cutting tool must be the same size as that used to machine the female hole or pocket into which you want to fit this straight insert.

---

If you want to amend the machining parameters for the selected tool, click on the  arrow in the **Tool** area. For further information, see "Adjusting Machining Parameters When Creating a Toolpath" on page 540.

When you have finished, click on the  arrow to hide the machining parameters.

9. To set the cut direction, click on the  arrow in the **Cut Direction** area of the page, then click on one of the **Cut Direction** radio buttons :
  - **Climb Mill** – In Climb Milling, the cutter rotates in the same direction as the feed motion.
  - **Conventional** – In Conventional Milling, the cutter rotates in the opposite direction to the feed motion. For more details, see "Overview" on page 403.





---

**Note:** You can set the default cutting direction in ArtCAM Pro using the **ArtCAM Options** page. For details, see "Managing ArtCAM Pro's Preferences" in the ArtCAM Pro Layout chapter.

---

10. To add ramping moves to the toolpath, click to select the **Add Ramping Moves** option . For more details, see "Overview" on page 403.

All of the ramping move settings are selected by default . If you do not want to use any of these settings, click to deselect each of those you do not want to use . The boxes for the deselected options are greyed-out.

You can use the ramping move settings as follows:

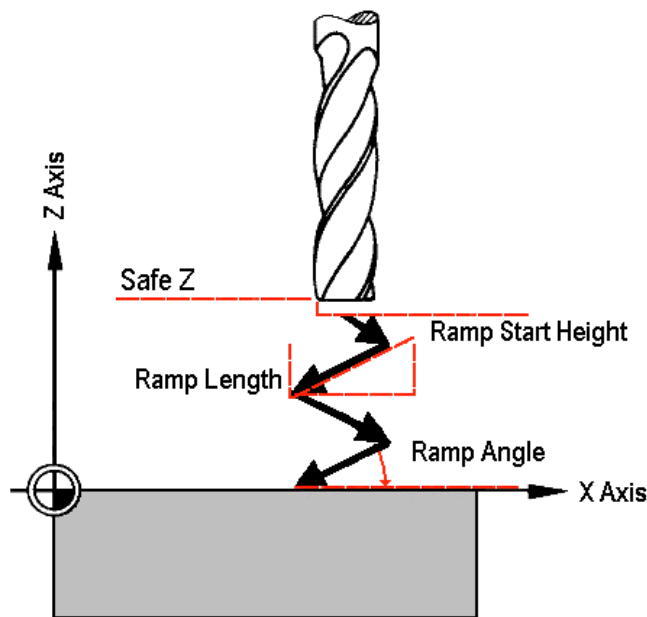

- Define the maximum angle of descent for each zig and zag movement of the cutting tool in the **Max Ramp Angle (A)** box.
  - Define the maximum distance that you want the cutting tool to zigzag across the material surface in the **Max Ramp Length (L)** box.
  - Define the minimum distance that you want the tool to zigzag across the material surface in the **Min Ramp Length (Lmin)** box.
  - If you want to set the height at which the ramping moves start, click to select the **Ramp Start Height (S)** option , and then define the start height in the box beneath. If you do not define the **Ramp Start Height (S)** here, the **Safe Z** level is used by default.
11. In the **Material** area, click on the **Setup** button to display the **Setup Job Dimensions** dialog box.
- Make sure that the block dimensions, the origin and the material Z zero position are correct, and then click on the **OK** button. If you want to change any of these settings, see "Creating a Model" in the Working with Models chapter.
12. If you do not want to preview the toolpath in the **2D View** window, click to deselect the **Create 2D Preview** option .



---

**Tip:** It is recommended that you create a 2D preview. You can always hide it from view by clicking on the **2D** option in the **Show in** area of the **Toolpaths** Home page.

---

13. Type a name for the toolpath in the **Name** box.
14. You can now specify when you want to calculate the toolpath:
  - If you want to calculate the toolpath now, click on the **Now** button.

The **Offsetting Contours** dialog box is displayed while ArtCAM Pro calculates the toolpath:

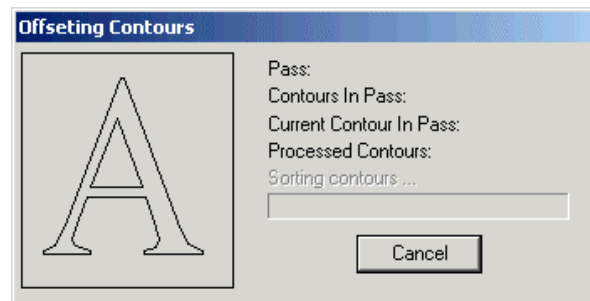

The passes used to machine the straight insert are represented by dark red lines drawn around the selected vector object's boundary:

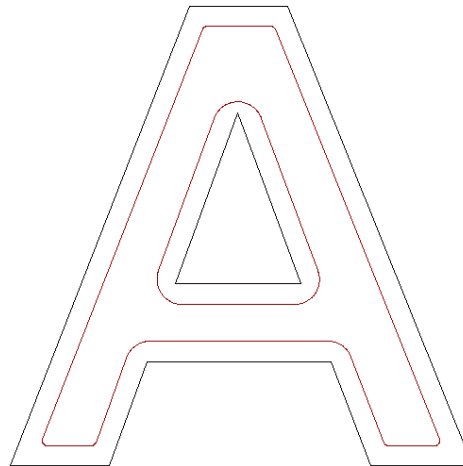

The toolpath preview is not shown if the **Create 2D Preview** option is deselected .

You can now simulate the toolpath. For details, see "Simulating Toolpaths" on page 567.

- If you want to calculate the toolpath at a later time, click on the **Later** button. For details, see

"Calculating a Single Toolpath" on page 548 and  
"Calculating a Batch of Toolpaths" on page 549.

15. Click on the **Close** button to return to the **Toolpaths** Home page.

If you want to add bridges to, add lead moves to, or change the start position in any of the profile passes in the Male Insert toolpath, see "Editing a Profile Pass" on page 527.

If you want to set the machining order of the profile passes in the Male Insert toolpath, see "Setting the Machining Order" on page 537.

## ***Creating a Stepped Insert***



This **Male Inlay** option displays the **Male Stepped Insert** page in the **Assistant** window. This allows you to create a male stepped insert from the block of material. You can then create a female stepped hole or stepped pocket to fit the male stepped insert into.

Using the **Male Stepped Insert** page, you can:

- Select a tool to cut the stepped insert out of the block.
- Control the depth and width of the insert shoulder.
- Control the cutting direction of the tool.

To create a stepped insert:

1. Click on the **Stepped** option  in the **Inlay Types** area of the **Inlay Wizard** page to display the **Male Stepped Insert** page in the **Assistant** window.
2. Define the depth (Z) from the material surface at which you want to create the stepped insert in the **Start Depth** box.
3. Define the depth (Z) of the bottom of the stepped insert in the **Finish Depth** box.
4. If you want to enlarge or reduce the stepped insert around the selected vector object, define the distance between the boundary of the selected vector object and the cutting tool in the **Allowance** box. Type a positive value to enlarge the stepped insert or a negative value to reduce it.
5. Define how closely you want the cutting tool to follow the shape of the vector object in the **Tolerance** box.
6. If you want to change the height at which the cutting tool makes rapid moves between toolpath segments:

7. In the **Shoulder Dimensions** area, define the relative depth of the shoulder from the **Start Depth** in the **Depth (d)** box.
8. Define the width of the shoulder in the **Width (s)** box.
9. In the **Tool** area, click on the **Select** button to display the **Tool Groups Database**:
10. Double-click on the tool you want to use. ArtCAM Pro closes the **Tool Groups Database** and displays the selected tool's description in the **Tool** area.
11. To set the cut direction, click on the  arrow in the **Cut Direction** area of the **Male Stepped Insert** page, then click on one of the **Cut Direction** radio buttons :
  - **Climb Mill** – In Climb Milling, the cutter rotates in the same direction as the feed motion.
  - **Conventional** – In Conventional Milling, the cutter rotates in the opposite direction to the feed motion. For more details, see "Overview" on page 403.





---

**Note:** You can set the default cutting direction in ArtCAM Pro using the **ArtCAM Options** page. For details, see "Managing ArtCAM Pro's Preferences" in the ArtCAM Pro Layout chapter.

---

12. To add ramping moves to the toolpath, click to select the **Add Ramping Moves** option . For more details, see "Overview" on page 403.
13. In the **Material** area, click on the **Setup** button to display the **Material Setup** dialog box.
14. If you do not want to preview the toolpath in the **2D View** window, click to deselect the **Create 2D Preview** option .
15. Type a name for the toolpath in the **Name** box.
16. You can now specify when you want to calculate the toolpath:
  - If you want to calculate the toolpath now, click on the **Now** button.

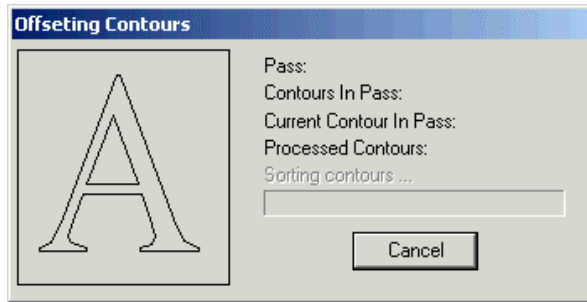
The **Offsetting Contours** dialog box is displayed while ArtCAM Pro calculates the toolpath:



The passes used to machine the stepped insert are represented by dark red lines drawn around the selected vector object's boundary:

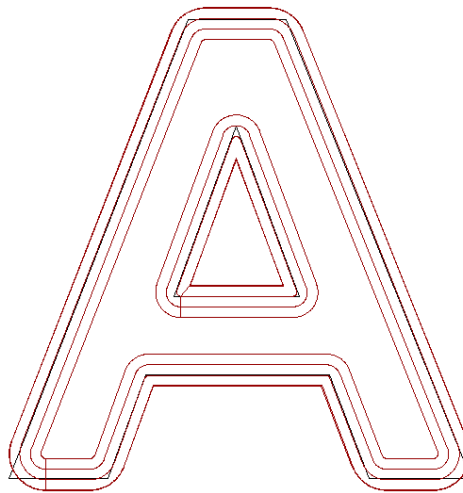

The toolpath preview is not shown if the **Create 2D Preview** option is deselected .

You can now simulate the toolpath. For details, see "Simulating Toolpaths" on page 567.

- If you want to calculate the toolpath at a later time, click on the **Later** button. If you have chosen to calculate the toolpath later, see "Calculating a Single Toolpath" on page 548 and "Calculating a Batch of Toolpaths" on page 549.

17. Click on the **Close** button to return to the **Toolpaths** Home page.

## Drill Holes

The **Drilling** button  in the **2D Toolpaths** area of the **Toolpaths** Home page allows you to create drill holes. The size of the drill hole is determined by the diameter of the cutting tool that is used during the machining process.

When drilling holes you can use peck drilling to reduce chip packing in the hole. The tool drills a short distance into the block of material, and then withdraws. The deeper the hole, the more frequent the drill must be retracted (or pecked) to be effective:

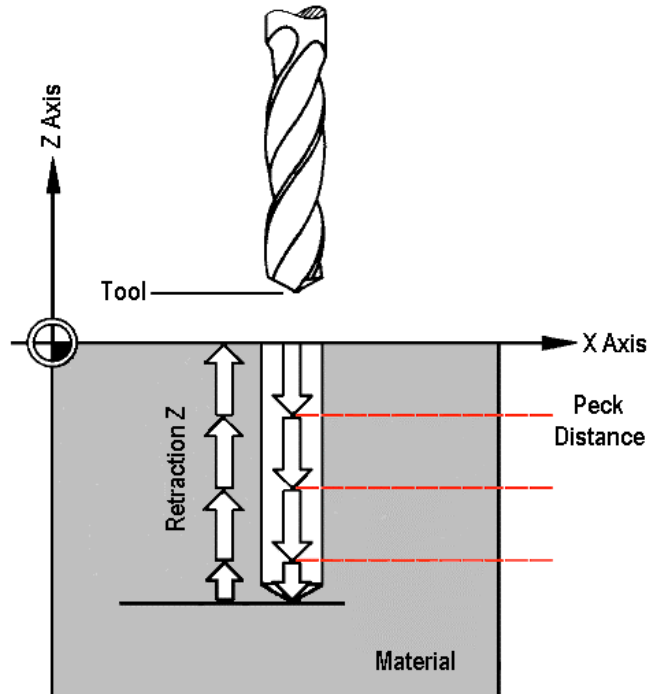

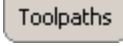

The selected tool is retracted from the block of material to the **Retraction Z** level when it reaches the level displayed in the **Stepdown** box in the **Tool** area of the page. The **Stepdown** is also referred to as the Peck Distance. The tool then continues to cut deeper into the block of material until the **Finish Depth** is reached or the **Stepdown** is reached again. In the latter instance, the tool retracts from the block of material to the **Retraction Z** level again. This cycle continues until the **Finish Depth** is finally reached.

To create drill holes in your model:

1. Click on the **Toolpaths** tab  to display the **Toolpaths** Home page.
2. If you are creating drill holes from vector objects, select those that you want to use. For details, see "Selecting Vectors" in the Working with Vectors chapter.

If you are creating drill holes from toolpaths, select the 2D toolpath previews that you want to use. For details, see "Selecting Toolpaths" on page 509.

3. Click on the **Drilling** button  in the **2D Toolpaths** area of the **Toolpaths** Home page to display the **Drilling** page.
4. Define the depth (Z) from the material surface at which you want to create the drill holes in the **Start Depth** box.
5. Define the depth (Z) of the bottom of each drill hole in the **Finish Depth** box.
6. If you want to change the height at which the cutting tool makes rapid moves between toolpath segments:
7. Click on the **Select** button in the **Tool** area of the page to open the **Tool Groups Database**:
8. Double-click on the tool you want to use. ArtCAM Pro closes the **Tool Groups Database** and displays the selected tool's description in the **Tool** area.
9. To set where the holes are drilled in your model, click on one of the **Drill Centre of...** radio buttons :
10. To drill the holes using the peck drilling method:
11. From the **Sequencing** area, you can set the order in which each segment in the toolpath is machined. You can either allow ArtCAM Pro to calculate the machining order, or use a polyline drawn to indicate the machining order.

If you want to ArtCAM Pro to calculate the order in which each segment in the toolpath is machined:

- First, click on the **Auto** radio button .
- Next, click on the list box and then on the option that you want to use for the machining order:

**Optimise** – Click on this option to instruct ArtCAM Pro to find the most efficient machining order.

**Use Text Order** – Click on this option to instruct ArtCAM Pro to machine according to the order in which the selected vector text was created. The cutting tool moves along the first line of text from left to right, until it locates a carriage return when it continues machining along the next line from right to left. This process is repeated until the last character in the last line of text is located.



**Left To Right** – Click on this option to instruct ArtCAM Pro to machine from the left of the model to the right.

**Right To Left** – Click on this option to instruct ArtCAM Pro to machine from the right of the model to the left.

**Bottom To Top** – Click on this option to instruct ArtCAM Pro to machine from the bottom of the model to its top.

**Top To Bottom** – Click on this option to instruct ArtCAM Pro to machine from the top of the model to the bottom.

**Spiral Out** – Click on this option to instruct ArtCAM Pro to machine from the centre of the model outwards in a spiral motion. This is particularly useful if you are using clamps to secure the material on your router.

**Spiral In** – Click on this option to instruct ArtCAM Pro to machine from the outside edge of the model inwards in a spiral motion.

If you want to manually set the order in which each segment in the toolpath is machined:

- First, click on the **Manual** radio button .
- Next, draw a polyline in the **2D View** indicating the order in which you want the toolpath segments to be machined. Its Start Point should be positioned close to the toolpath segment from which you want to begin machining. For details, see "Creating a Polyline" in the Working with Vectors chapter.
- Next, click to select the polyline that you want to use, and then click on the **Select Vector** button. The *No Vector Selected* message in red text changes to *Vector Selected* in blue text.

If you do not select an open, ungrouped vector object, the following message box appears:

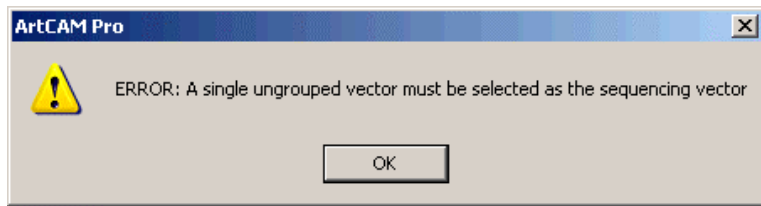

Click on the **OK** button to close the message box, and then repeat this step.

If you want to change the polyline you have selected, click on the **Cancel Selection** button and then repeat this step.

- Finally, make sure that the vector object(s) that you want to drill are selected. For details, see "Selecting Vectors" in the Working with Vectors chapter.
12. In the **Material** area, click on the **Setup** button to display the **Material Setup** dialog box.  
Make sure that the block dimensions, the origin and the material Z zero position are correct, and then click on the **OK** button. If you want to change any of these settings, see "Creating a Model" in the Working with Vectors chapter.
  13. If you do not want to preview the toolpath in the **2D View** window, click to deselect the **Create 2D Preview** option .



---

**Tip:** It is recommended that you create a 2D preview. You can always hide it from view by clicking on the **2D** option in the **Show in** area of the **Toolpaths** Home page.

---

14. Type a name for the toolpath in the **Name** box.
15. You can now specify when you want to calculate the toolpath:
  - If you want to calculate the toolpath now, click on the **Now** button.

The passes used to machine the drill holes are represented by dark red circles drawn according to the selected **Drill Centre of...** option.

The toolpath preview is not shown if the **Create 2D Preview** option is deselected .

You can now simulate the toolpath. For details, see "Simulating Toolpaths" on page 567.

- If you want to calculate the toolpath at a later time, click on the **Later** button. For details, see "Calculating a Single Toolpath" on page 548 and "Calculating a Batch of Toolpaths" on page 549.

16. Click on the **Close** button to return to the **Toolpaths** Home page.

---

## 3D Toolpaths

ArtCAM Pro provides a number of three-dimensional toolpaths that you can use to machine your model, based on the vector objects and/or relief created within it. These include:

- **Machining a Relief.** This strategy allows you to machine any relief that you have created in a model. For details, see "Machine Relief" on page 481.
- **Feature Machining.** This strategy is used to machine the **Raised, Recessed** and **Centreline Engraved** features you have created from vector objects in a model. For details, see "Feature Machining" on page 486.
- **Z Level Roughing.** This strategy allows you to quickly remove unwanted material from a relief. For details, see "Z Level Roughing" on page 490.
- **3D Laser Machining.** This strategy allows users of a laser-engraving machine to quickly remove layers of unwanted material from a relief. For details, see "Laser Machining" on page 495.
- **Cutting Out.** This strategy allows you to create a toolpath either inside or outside the boundary of a vector object. For details, see "3D Cut Out" on page 498.
- **3D Rest Machining.** Rest (as in 'rest of material') Machining allows you to find all of the areas of a relief that cannot be machined based on one tool size, and then machine only these areas with another, smaller tool. For details, see "3D Rest Machining" on page 505.

### Machine Relief





The **Machine Relief** button  in the **3D Toolpaths** area of the **Toolpaths** Home page allows you to:

- Machine the entire surface of a relief.
- Machine a specific area of a relief, as defined by a selected vector object.

Using the **Machine Relief** page, you can:

- Select a different tool clearance strategy for each of the tools you want to use. Depending on what strategy you select, you can control the angle, or where and in what direction the tool cuts into the block of material.
- Control how the tool cuts into and retracts from the block of material by adding ramping moves.

To machine the surface of a relief:

1. Click on the **Toolpaths** tab  to display the **Toolpaths** Home page.
2. Click on the **Machine Relief** button  in the **3D Toolpaths** area to display the **Machine Relief** page.
3. Click on one of the **Area to Machine** radio buttons  to select how the relief is machined:
  - Click on the **Whole Model** radio button  if you want to machine the entire surface of the relief.
  - Click on the **Selected Vector** radio button  if you want to machine an area of the relief as defined by a selected vector object.  
 If you select this option, select the vector object that represents the area of the relief you want to machine. For details, see "Selecting Vectors" in the Working with Vectors chapter.
4. Click on the **Strategy** list box to display the strategies available and then on the strategy you want to select. If you have selected the **Whole Model** option, then you can choose from the following strategies:
  - **Raster in X** – This strategy machines back and forth along the X-axis at a specified angle.
  - **Raster in X and Y** – This strategy machines in two perpendicular directions at a specified angle. This strategy improves the surface finish but can be time consuming.

- **Spiral** – This strategy machines in a spiral motion, stopping when the tool reaches the first edge of the relief. This strategy does not always allow you to machine the entire relief.
- **Spiral in Box** – This strategy machines in a spiral motion. When the tool reaches the first edge of the relief it retracts, traverses along the edge of the relief and then plunges to continue machining the next area of the relief. This strategy allows you to machine the entire relief, but can be time consuming.

If you have selected the **Selected Vector** option, then you can choose from the following strategies:

- **Raster in X** – This strategy machines back and forth along the X-axis at a specified angle.
- **Offset** – This strategy machines in repeated passes, each time moving inwards by the **Stepover** value of the tool you use. You can see the **Stepover** value of the selected tool when the machining parameters are displayed in the **Tool** area.

5. If you have selected a **Raster** strategy, type the angle at which you want the tool to move in the **Raster Angle** box.





---

**Note:** You can set the default offset start point using the **ArtCAM Options** page. For details, see "Managing ArtCAM Pro's Preferences" in the ArtCAM Pro Layout chapter.

---

6. To leave additional material on the relief surface to allow for the final machining pass, type a value in the **Allowance** box. The allowance sets the distance between the surface of the relief and the cutting tool.
7. Type a value in the **Tolerance** box to specify how closely you want the cutting tool to follow the shape of the relief.
8. If you want to change the height at which the machining tool makes rapid moves between toolpath segments:
  - First, click on the  arrow in the **Machine Safe Z** area to display the **Safe Z** box and the **Home Position's X, Y and Z** boxes.
  - Next, define the height in the **Safe Z** box.

If you want to define the **Home Position** for the machining tool:

- First, define its position along the X, Y and Z axes in the **Home Position's X, Y and Z** boxes.
- Next, click on the  arrow in the **Machine Safe Z** area to hide the **Safe Z** box and the **Home Position's X, Y and Z** boxes.

9. Click on the **Select** button in the **Tool** area to open the **Tool Groups Database**:

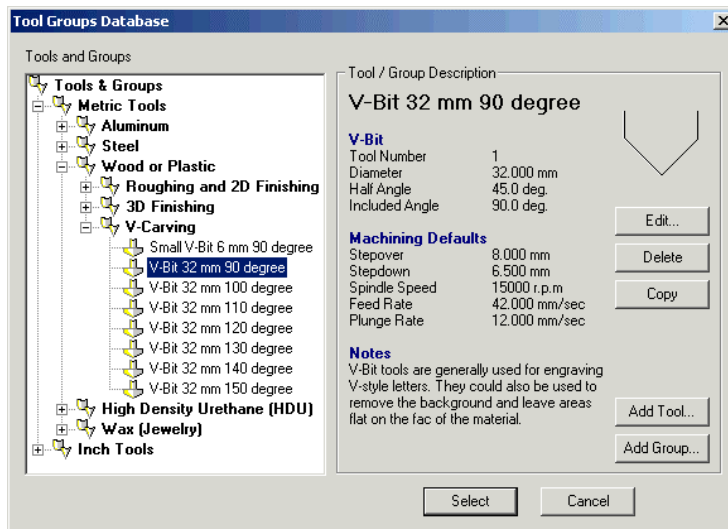

10. Double-click on the tool that you want to use. ArtCAM Pro closes the **Tool Groups Database** and displays the selected tool's description in the **Tool** area.

If you want to amend the machining parameters for the selected tool, click on the  arrow in the **Tool** area. For further information, see "Adjusting Machining Parameters When Creating a Toolpath" on page 540.

When you have finished, click on the  arrow to hide the machining parameters.

11. To define the point at which the machining tool enters and leaves the block of material:

- First, click to select the **Do Multiple Z Passes** option .
- Next, type a value in the **Z Height of First Pass** box.
- Finally, type a value in the **Z Height of Last Pass** box.



---

**Note:** The **Stepdown** value of the tool determines the number of passes made between the first and last pass in the toolpath.

---

12. To add ramping moves to the toolpath, click to select the **Add Ramping Moves** option . The ramping moves settings are displayed:

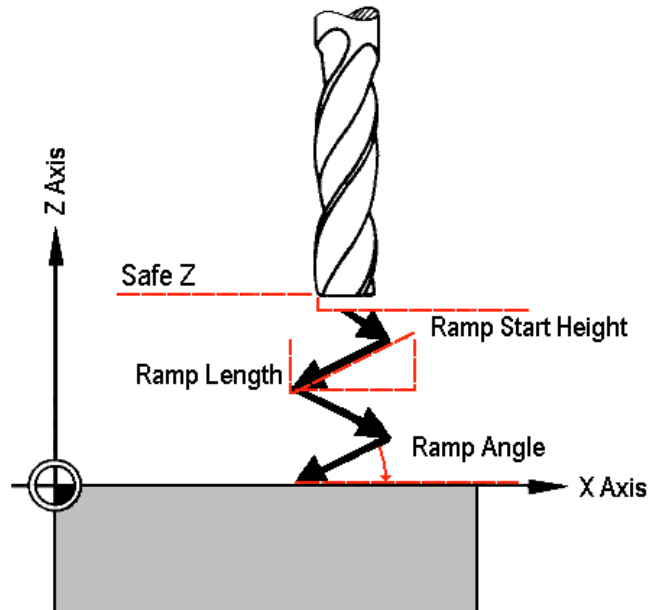

- Type the maximum angle of descent for each zig and zag movement of the cutting tool in the **Max Ramp Angle (A)** box.
  - Type the maximum distance that you want the cutting tool to zigzag across the relief surface in the **Max Ramp Length (L)** box.
  - Type the minimum distance that you want the cutting tool to zigzag across the relief surface in the **Min Ramp Length (Lmin)** box.
  - If you want to define the height at which the ramping moves start, click to select the **Ramp Start Height (S)** option , and then type a value in the box beneath it. If you do not define the **Ramp Start Height (S)** here, the **Safe Z** level is used.
13. Click on the **Setup** button in the **Material** area to display the **Material Setup** dialog box.
14. Type a name for the toolpath in the **Name** box.

15. You can now specify when you want to calculate the toolpath:
  - If you want to calculate the toolpath now, click on the **Now** button.
  - If you want to calculate the toolpath as part of a batch of toolpaths at a later time, click on the **Later** button. For details, see "Creating a Single Copy" on page 512 and "Calculating a Batch of Toolpaths" on page 549.
16. Click on the **Close** button to return to the **Toolpaths** Home page.



## Feature Machining

The **Feature Machining** button  in the **Toolpaths** Home page allows you to machine a raised, recessed or centreline engraved feature that you have created from a vector object with a depth or height relative to the current relief. The contour of the existing relief is preserved in the feature that is combined with it. For details, see "Creating a Feature from a Vector" in the Working with Vectors chapter.

Using the **Feature Machining** page, you can:

- Select a tool clearance strategy for the machining tool you want to use. Depending on the strategy you select, you can control the angle, where and in what direction the machining tool cuts into the block of material.

To machine a feature that you have created from a vector object:

1. Click on the **Toolpaths** tab  to display the **Toolpaths** Home page.
2. Click on the **Feature Machining** button  in the **3D Toolpaths** area to display the **Feature Machining** page.
3. Click on the **Choose Feature** list box to display the list of features available and then on the feature that you want to machine.



---

**Tip:** If you move the mouse cursor over a feature in the **Choose Feature** list box, a pop-up window appears detailing the attributes of the feature.

---





---

**Warning:** If you have not yet created a feature from a vector object, the **Choose Feature** list box is empty. For details, see "Creating a Feature from a Vector" in the Working with Vectors chapter.

---

4. Click on either of the radio buttons  to select the machining strategy that you want to use:
  - **Profile Only** – This strategy allows the cutting tool to make profile passes around the feature you have selected.
  - **Area Clear** – This strategy allows the cutting tool to clear an area of material based on the boundary of the feature you have selected, then make profile passes around the feature.



---

**Note:** The selected feature is not machined using the **Area Clear** strategy. A protected area is created around the selected feature during the machining process.

---

If you have selected **Area Clear**, type a value in the **Overcut Distance** box to remove any ridge of unwanted material that might appear around the feature.

For example, if a Ball Nose cutting tool is used as the **Feature Tool** with an **Area Clear** strategy, a ridge of unmachined material may appear around it:

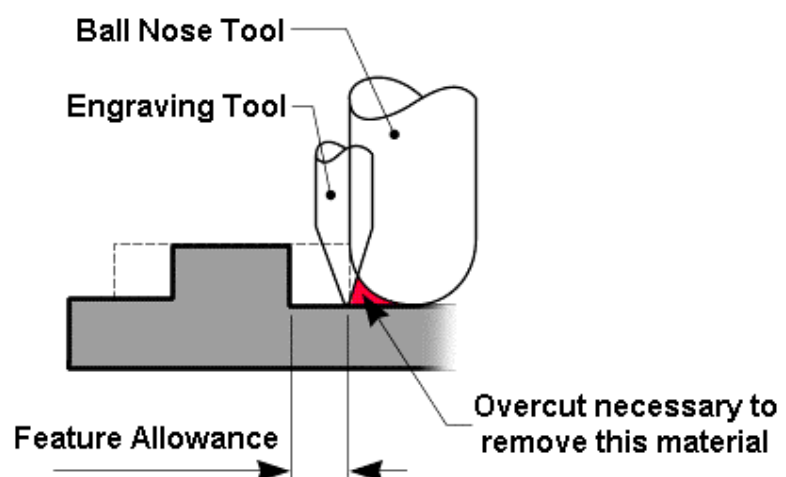

---

**Note:** The **Overcut Distance** should normally be equal to the radius of the **Feature Tool** used in an **Area Clear** strategy.

---

5. If you want the cutting tool to sharpen the corners in the feature as it is machined, click to select the **Corner Sharpen** option .
6. To perform the machining strategy that you have selected as a series of passes in the Z direction, click to select the **Do Multiple Z Passes** option .
7. Click on either of the radio buttons  to select how the cutting tool reaches the depth you defined when creating the feature. For details, see "Creating a Feature" in the Working with Vectors chapter.
8. Click on either of the radio buttons  to select the cut direction you want to use:
  - **Climb** – In Climb Milling, the cutter rotates in the same direction as the feed motion.
  - **Conventional** – In Conventional Milling, the cutter rotates in the opposite direction to the feed motion.

For more details, see "Overview" on page 403.



---

**Note:** You can set the default cutting direction using the **ArtCAM Options** page. For details, see "Managing ArtCAM Pro's Preferences" in the ArtCAM Pro Layout chapter.

---

9. Type a value in the **Tolerance** box to specify how closely you want the cutting tool to follow the shape of the selected feature.
10. If you want to change the height at which the machining tool makes rapid moves between toolpath segments:
  - First, click on the  arrow in the **Machine Safe Z** area to display the **Safe Z** box and the **Home Position's X, Y and Z** boxes.
  - Next, define the height in the **Safe Z** box.

If you want to define the **Home Position** for the machining tool:

- First, define its position along the X, Y and Z axes in the **Home Position's X, Y and Z** boxes.
- Next, click on the  arrow in the **Machine Safe Z** area to hide the **Safe Z** box and the **Home Position's X, Y and Z** boxes.

- Click on the **Select** button in the **Feature Tool** area of the page to open the **Tool Groups Database**:

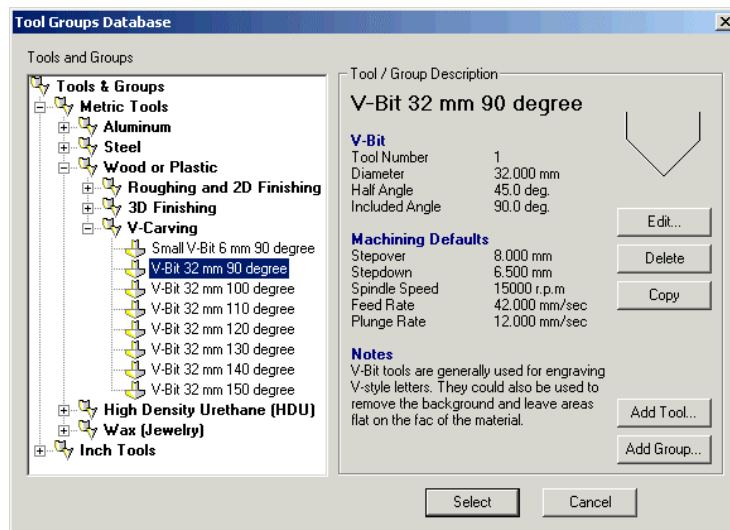

- Double-click on the tool that you want to use. ArtCAM Pro closes the **Tool Groups Database** and displays the selected tool's description in the **Feature Tool** area.
- If you want to amend the machining parameters for the selected tool, click on the arrow in the **Feature Tool** area. For further information, see "Adjusting Machining Parameters When Creating a Toolpath" on page 540.

When you have finished, click on the arrow to hide the machining parameters.

- Click on the **Setup** button in the **Material** area of the page to display the **Material Setup** dialog box.

Make sure that the thickness of the block, the material Z zero position and the position of the model in the block is correct, then click on the **OK** button.

If you want to change any of these settings, see "Adjusting the Material Setup" on page 562.

- Type a name for the toolpath in the **Name** box.
- You can now specify when you want to calculate the toolpath:

- If you want to calculate the toolpath now, click on the **Now** button.

The **Offsetting Contours** dialog box is displayed while ArtCAM Pro calculates the toolpath:

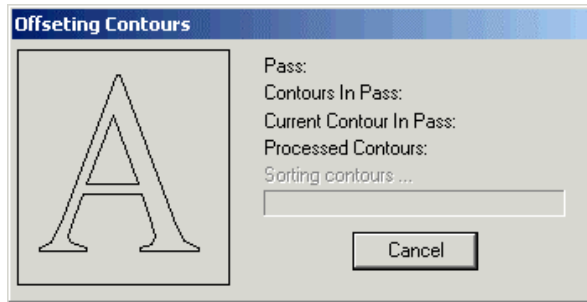

The machining passes used to create the selected feature are represented by blue lines drawn on the boundary of the vector object from which the feature was previously created. For details, see “Creating a Feature” in the Working with Vectors chapter.

You can now simulate the toolpath. For details, see "Simulating Toolpaths" on page 567.

- If you want to calculate the toolpath as part of a batch of toolpaths at a later time, click on the **Later** button. For details, see "Creating a Single Copy" on page 512 and "Calculating a Batch of Toolpaths" on page 549.

17. Click on the **Close** button to return to the **Toolpaths** Home page.

## Z Level Roughing

The **Z Level Roughing** button  in the **3D Toolpaths** area of the **Toolpaths** Home page allows you to quickly remove unwanted material from a relief in planar slices. The machining process involves a series of passes in the Z direction at a specified depth. You can remove material across the entire surface of the relief or in selected areas, as defined by a selected vector object.



---

**Warning:** You should only use an End Mill tool with this toolpath strategy. If any other shape of tool is used, additional material is left on the relief.



---

Using the **Z Level Roughing** page, you can:

- Select the roughing tool you want to use.
- Control how the tool cuts into and retracts from the block of material by adding ramping moves.

- Depending on what strategy you select, you can control the angle, or where and in what direction the roughing tool cuts into the block of material.

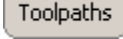
To remove a cross section of a relief in the Z direction:

1. Click on the **Toolpaths** tab  to display the **Toolpaths** Home page.
2. Click on the **Z Level Roughing** button  in the **3D Toolpaths** area to display the **Z Level Roughing** page.
3. Click on either of the **Area to Machine** radio buttons  to select how the material is removed from the relief:
  - Click on the **Complete Relief** radio button  if you want to remove material across the entire surface of the relief.
  - Click on the **Area under selected vectors** radio button  if you want to remove material in an area of the relief, as defined by a selected vector object.

If you select this option, select the vector object that represents the area of the material that you want to remove from the relief. For details, see "Selecting Vectors" in the Working with Vectors chapter.

4. Click on the **Select** button in the **Roughing Tool** area to display the **Tool Groups Database**:
5. Double-click on the tool you want to use. ArtCAM Pro closes the **Tool Groups Database** and displays the selected tool's description in the **Roughing Tool** area.
6. Click on the **Setup** button in the **Material** area to display the **Material Setup** dialog box.

Make sure that the thickness of the block, the material Z zero position and the position of the model in the block is correct, then click on the **OK** button.

If you want to change any of these settings, see "Adjusting the Material Setup" on page 562.

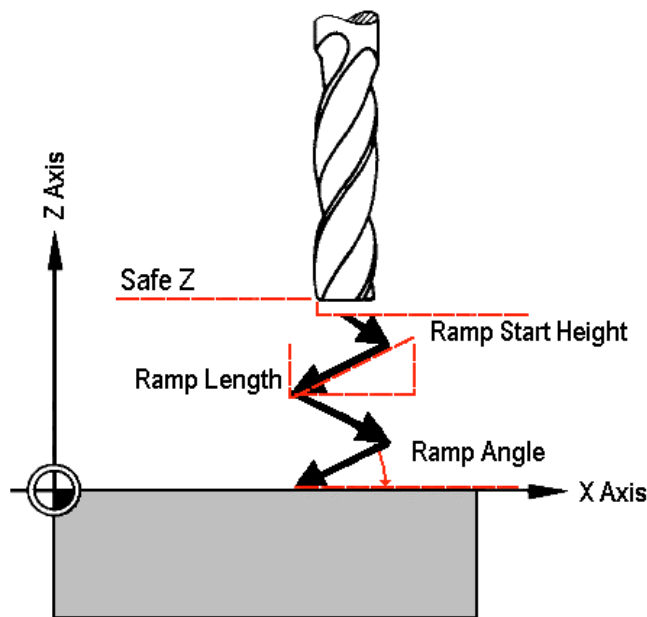

7. To add ramping moves to the toolpath, click to select the **Add Ramping Moves** option . The ramping moves settings are displayed:



- Type the maximum angle of descent for each zig and zag movement of the cutting tool in the **Max Ramp Angle (A)** box.
  - Type the maximum distance that you want the cutting tool to zigzag across the relief surface in the **Max Ramp Length (L)** box.
  - Type the minimum distance that you want the cutting tool to zigzag across the relief surface in the **Min Ramp Length (Lmin)** box.
  - If you want to define the height at which the ramping moves start, click to select the **Ramp Start Height (S)** option , and then type a value in the box beneath it. If you do not define the **Ramp Start Height (S)** here, the **Safe Z** level is used.
8. If you want to control the number of Z passes used to machine the relief:
- First, type a value in the **Start/Surface Z** box in the **Z Slices** area of the page to set the position of the first Z pass.
  - If you want to add or remove extra material from the relief surface, type a value in the **Material Allowance** box. The allowance sets the distance between the surface of the relief and the cutting tool.

- Next, type a value in the **Last Slice Z** box to set the position of the final Z pass.
  - Finally, click on the **Apply** button to confirm your settings.
9. If you want to change the height at which the cutting tool makes rapid moves between toolpath segments:
- First, click on the  arrow in the **Machine Safe Z** area to display the **Safe Z** box and the **Home Position's X, Y and Z** boxes.
  - Next, define the height in the **Safe Z** box.

If you want to define the **Home Position** for the machining tool:

- First, define its position along the X, Y and Z axes in the **Home Position's X, Y and Z** boxes.
  - Next, click on the  arrow in the **Machine Safe Z** area to hide the **Safe Z** box and the **Home Position's X, Y and Z** boxes.
10. Type a value in the **Tolerance** box to specify how closely you want the cutting tool to follow the shape of the relief.
11. Click on either of the radio buttons  to select the machining strategy that you want to use:
- **Raster** – This strategy machines back and forth along the X-axis at a specified angle.

If you select **Raster**, first type the angle you want the tool to move at in the **Angle** box.



---

**Note:** You can set the default raster angle using the **ArtCAM Options** page. For details, see "Managing ArtCAM Pro's Preferences" in the ArtCAM Pro Layout chapter.

---

Next, click on one of the **Profile Pass** radio buttons :

**None** – Select this option if you do not want the tool to profile the relief.

**First** – Select this option if you want the tool to profile the relief first and then raster clear the area.

**Last** – Select this option if you want the tool to move outwards to raster clear the area, then profile the relief.

- **Offset** – This strategy machines in repeated passes, each time moving inwards by the **Stepover** value of the tool you use.

If you have selected **Offset**, first click on one of the **Cut Direction** radio buttons :

**Climb** – In Climb Milling, the cutter rotates in the same direction as the feed motion.

**Conventional** – In Conventional Milling, the cutter rotates in the opposite direction to the feed motion.

For more details, see "Overview" on page 403.



---

**Note:** You can set the default cutting direction in ArtCAM Pro using the ArtCAM Options page. For details, see "Managing ArtCAM Pro's Preferences" in the ArtCAM Pro Layout chapter.

---

Next, click on one of the **Start From** radio buttons :

**Outside** – Select this option if you want the tool to cut into the material at the boundary of the relief surface, then machine inwards.

**Inside** – Select this option if you want the tool to cut into the material at the centre of the relief surface, then machine outwards.



---

**Note:** You can set the default offset start point using the **ArtCAM Options** page. For details, see "Managing ArtCAM Pro's Preferences" in the ArtCAM Pro Layout chapter.

---

12. Type a name for the toolpath in the **Name** box.
13. You can now specify when you want to calculate the toolpath:
  - If you want to calculate the toolpath now, click on the **Now** button.

You can now simulate the toolpath. For details, see "Simulating Toolpaths" on page 567.



- If you want to calculate the toolpath as part of a batch of toolpaths at a later time, click on the **Later** button. For details, see "Creating a Single Copy" on page 512 and "Calculating a Batch of Toolpaths" on page 549.

14. Click on the **Close** button to return to the **Toolpaths** Home page.

## Laser Machining

The **3D Laser Machining** button  in the **3D Toolpaths** area of the **Toolpaths** Home page allows users of a laser-engraving machine to quickly remove layers of unwanted material from a relief. The machining process involves a laser beam making a series of passes in the Z direction at a specified depth.

Using the **Laser Machining** page, you can:

- Control whether the laser machines from the base or the surface of the relief.
- Output the toolpath in segments to allow for any refocusing of the laser that might be required between passes.
- Depending on what strategy you select, you can control the angle, or where and in what direction the laser cuts into the block of material.
- Engrave detail into a previously machined model, using two reliefs. This process is known as Rest (as in 'rest of material') Laser Engraving.





---

**Important:** The toolpath(s) need to be saved as an output file using a suitable post-processor such as the 2D HPGL (\*.plt) before being sent to a laser engraving machine. For details, see "Saving a Toolpath" on page 543.

---

To remove layers of a relief in the Z direction using a laser engraving machine:

1. Click on the **Toolpaths** tab  to display the **Toolpaths** Home page.
2. Click on the **3D Laser Machining** button  in the **3D Toolpaths** area to display the **Laser Machining** page.

3. Click on the **Setup** button in the **Material** area to display the **Material Setup** dialog box.

Make sure that the thickness of the block, the material Z zero position and the position of the model in the block is correct, then click on the **OK** button.

If you want to change any of these settings, see "Adjusting the Material Setup" on page 562.

4. If you want to control the number of Z passes used to laser machine the relief, you can:
  - Type a value in the **Start/Surface Z** box to set the position of the first Z pass.
  - To enlarge or reduce the relief, type a value in the **Material Allowance** box. The allowance sets the distance between the surface of the relief and the cutting tool. Type a positive value to enlarge the relief or a negative value to reduce it.
  - Type a value in the **Last Slice Z** box to set the position of the final Z pass.
  - To machine from the base of the relief upwards, click to select the **Reverse Tool Slice Order** option .
  - Click on the **Apply** button to confirm your settings.
5. In the **Toolpath Section(s)** area, click on either of the radio buttons  to select how the toolpath is calculated:
  - **Output One Toolpath** – This option allows you to laser machine the entire relief at once.
  - **Output In Sections** – This option allows you to laser machine the relief in segments. If you select this option, type a value in the **Section Thickness** box to set the depth of each toolpath segment.
6. In the **Slice Type** area, click on either of the radio buttons  to set the type of strategy you want to use when laser machining the relief:
  - **Profile** – This strategy machines around the boundary of the relief surface.
  - **Raster Clearance** - This strategy machines back and forth at a specified angle.

If you have selected **Raster Clearance**, first type a value in the **Stepover** box to set the distance between each Z pass. This value should be appropriate to the diameter of the laser beam on your laser-engraving machine.

Next, type the angle increment at which you want the laser to move during each Z pass in the **Angle Increment** box.



---

**Note:** You can set the default raster angle using the **ArtCAM Options** page. For details, see "Managing ArtCAM Pro's Preferences" in the ArtCAM Pro Layout chapter.

---

If you want to remove the material, click to select the **Remove Material** option .

7. If you want to rest laser engrave, the current relief should contain all the engraved detail you want to include in the laser machined model. You also must have already saved the relief prior to any engraved detail being added. To rest laser engrave the relief:
  - First, click to select the **3D Rest Laser Engraving** option . The **Load** button is displayed.
  - Next, load the relief representing the model prior to the addition of any engraved detail by clicking on the **Load** button to display the **Open** dialog box:

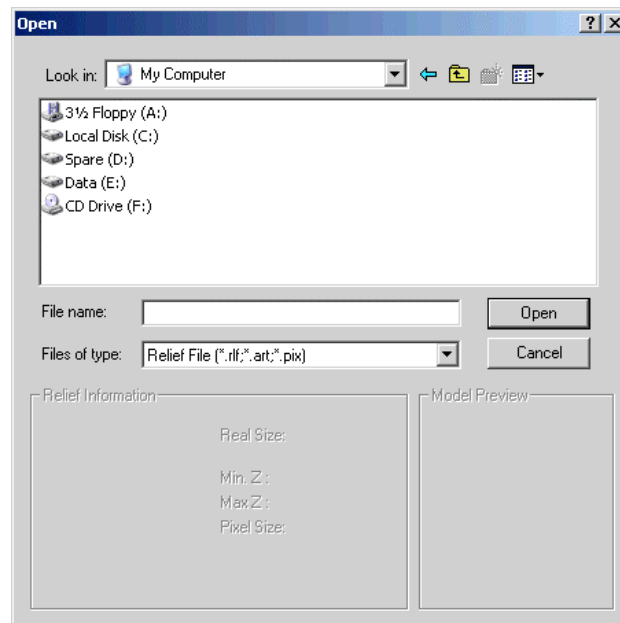

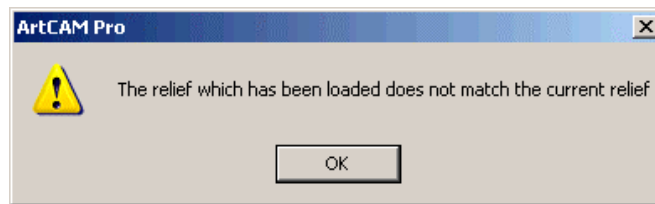

- Next, click on the **Look in** list box and select the directory where the relief file that you want to load is stored.
- Once you have found the relief file, click to select it from the main window of the **Open** dialog box. Its name appears in the **File Name** box.
- Finally, click on the **Open** button to load the relief.

If the relief is not the same size as the current relief, the following message box appears:



Click on the **OK** button to close the message box., and then repeat these steps making sure that the size of the imported relief matches that of the current relief.

8. Type a name for the toolpath in the **Name** box.
9. Click on the **Calculate** button to calculate the toolpath. If you are rest laser engraving, ArtCAM Pro generates the toolpaths needed to laser machine the differences between the two reliefs.

During the toolpath calculation process, ArtCAM Pro displays the **Generating Slices** progress bar and a **Cancel** button  beneath the design window area. If you want to stop ArtCAM Pro generating the Z slices in the toolpath, click on the **Cancel** button .

You can now simulate the toolpath. For details, see "Simulating Toolpaths" on page 567.

10. Click on the **Close** button to return to the **Toolpaths** Home page.



## 3D Cut Out

The **3D Cut Out** button  in the **3D Toolpaths** area of the **Toolpaths** Home page allows you to create a toolpath that machines either inside or outside the boundary of a selected vector object using absolute Z values.

Using the **3D Cut Out** page, you can:

- Control where your tool cuts into and retracts from the block of material by adding lead in and lead out moves.
- Control how your tool cuts into the block of material by adding ramping moves.
- Control the cutting direction of the tool.
- Control whether the vector object is cut or snapped out from the block of material by adding bridging.

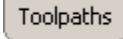
To cut out a vector object from the relief:

1. Click on the **Toolpaths** tab  to display the **Toolpaths** Home page.
2. Click on the **3D Cut Out** button  in the **3D Toolpaths** area to display the **3D Cut Out** page.
3. Select the vector object that represents the area of the material that you want to cut from the relief. For details, see "Selecting Vectors" in the Working with Vectors chapter.
4. In the **Profile Side** area, select how you want to profile the selected vector object:
  - Click on the **Outside** radio button  to instruct the tool to profile outside of the selected vector object
  - Click on the **Inside** radio button  to instruct the tool to profile inside of the selected vector object.
5. Type the absolute Z value from which the position of the first profile pass is to be calculated in the **Surface Z** box.
6. Type the absolute Z value from which the position of the first profile pass is to be calculated in the **Surface Z** box.
7. Type the absolute Z zero value for the bottom of the cut in the **Finish Z** box.
8. If you want to add or remove extra material around the vector object, you can type a value in the **Allowance** box. The value you enter sets the distance between the boundary of the selected vector object and the cutting tool. Type a positive value to add material or a negative value to remove it.
9. Type a value in the **Tolerance** box to specify how closely you want the cutter to follow the shape of the vector object.

10. If you want to change the height at which the cutting tool makes rapid moves between toolpath segments:

- First, click on the  arrow in the **Machine Safe Z** area to display the **Safe Z** box and the **Home Position's X, Y and Z** boxes.
- Next, define the height in the **Safe Z** box.



If you want to define the **Home Position** for the machining tool:

- First, define its position along the X, Y and Z axes in the **Home Position's X, Y and Z** boxes.
- Next, click on the  arrow in the **Machine Safe Z** area to hide the **Safe Z** box and the **Home Position's X, Y and Z** boxes.

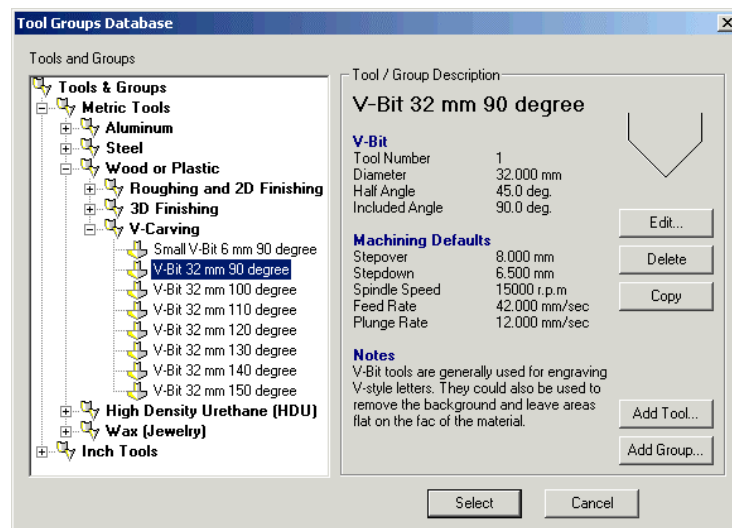
11. Click on the **Select** button in the **Profiling Tool** area of the page to open the **Tool Groups Database**:



12. Double-click on the tool that you want to use. ArtCAM Pro closes the **Tool Groups Database** and displays the selected tool's description in the **Profiling Tool** area.

13. The cutting direction defaults to **Climb Mill**. If you want to change this, click on the  arrow in the **Cut Direction** area of the **3D Cut Out** page, then click on one of the **Cut Direction** radio buttons :

- **Climb Mill** – In Climb Milling, the cutter rotates in the same direction as the feed motion.
- **Conventional** – In Conventional Milling, the cutter rotates in the opposite direction to the feed motion.

For more details, see "Overview" on page 403.



---

**Note:** You can set the default cutting direction in ArtCAM Pro using the ArtCAM Options page. For details, see "Managing ArtCAM Pro's Preferences" in the ArtCAM Pro Layout chapter.

---

14. If you only want to have a lead-in move, click to select the **Do not Lead Out** option .

- If you only want to have a lead-in move, click to select the **Do not Lead Out** option .
- Type the distance from the toolpath that you want the tool to cut into and retract from the block of material in the **Distance (D)** box.
- Select how you want the tool to move using the **Add Lead In/Out Moves** radio buttons .

**Linear** – Click on the **Linear** option  to instruct the tool to lead into and out of the vector object's boundary in a straight-line motion:

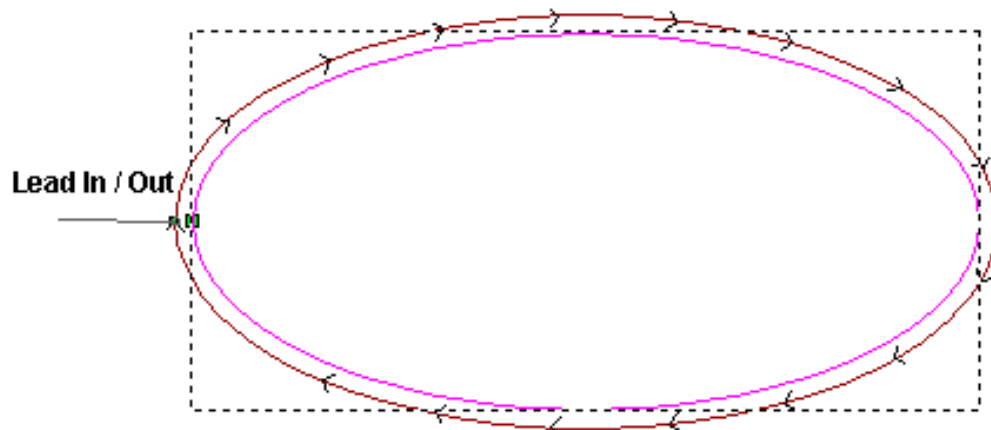

If you select the **Linear** option, define the angle of the linear lead moves in the **Angle In** and **Angle Out** boxes.

When editing lead moves associated with a profile pass used to machine inside of a defined area, the distance of a linear lead move or the radius of a circular arc move is now considered.

When adjusting the position of a linear lead move, ArtCAM checks to ensure that the distance of the lead move remains within the boundary of the profile pass. If the current distance of the lead move

intersects with the profile pass, its distance will be cropped so that it does not.

When adjusting the position of a circular arc lead move, ArtCAM checks to ensure that the radius of the lead move remains within the boundary of the profile pass. If the current radius of the lead move intersects with the profile pass, the lead move is converted to a linear move instead with a distance that does not.

**Circular Arc** – Click on the **Circular Arc** option  to instruct the tool to lead into and out of the vector object's boundary in an arc motion:

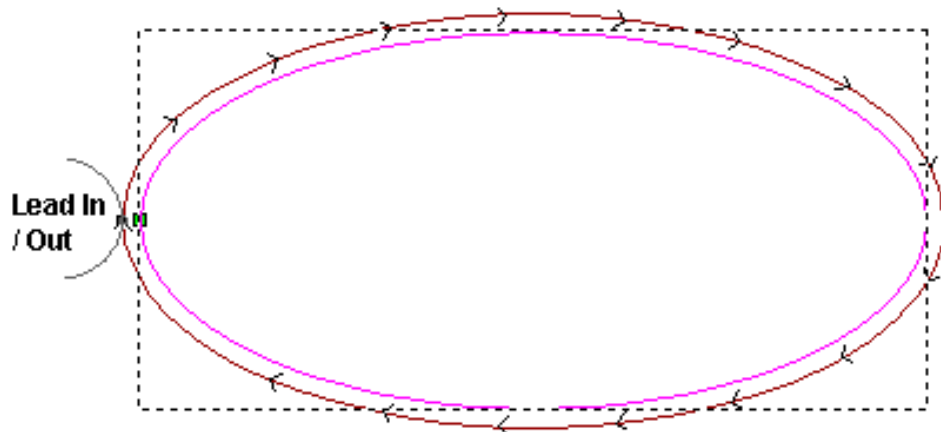

If you select the **Circular Arc** option, define the radius of the arc in the **Radius (R)** box. The radius must be less than or equal to the value in the **Distance (D)** box, otherwise the following message box appears when you calculate the toolpath:

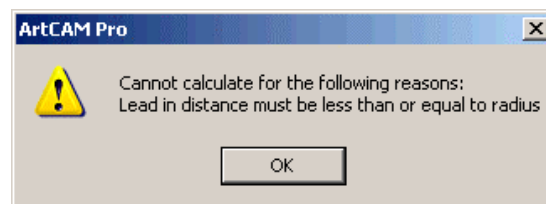

- Set the **Automatic Positioning** as follows:

To position lead-in and lead-out moves at the optimum point in the vector object, click to select the **Automatic Positioning** option . This point usually within the vector object's longest span.

If the **Automatic Positioning** option is deselected , the lead-in and lead-out moves are positioned at the Start Point of the vector object. If you change the Start Point, this



changes the position of the lead-in and lead-out moves. For details on changing the Start Point, see "Changing the Start Point" in the Working with Vectors chapter.

15. To add ramping moves to the toolpath, click to select the **Add Ramping Moves** option . The ramping moves settings are displayed:

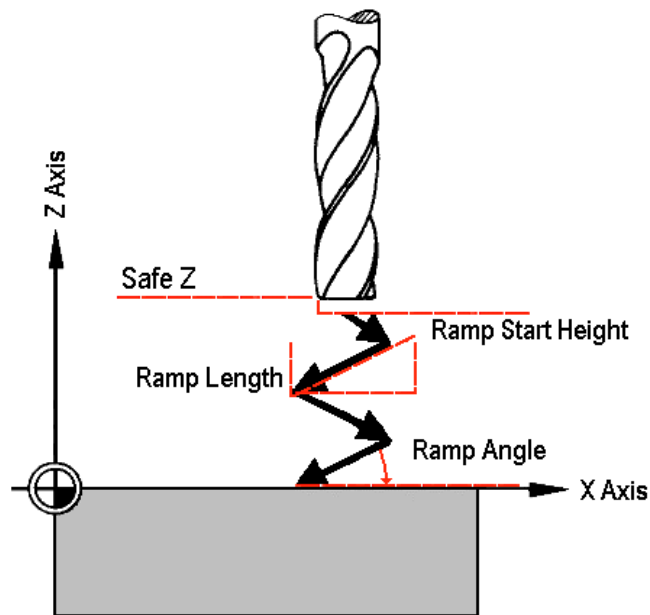

- Type the maximum angle of descent for each zig and zag movement of the cutting tool in the **Max Ramp Angle (A)** box.
- Type the maximum distance that you want the cutting tool to zigzag across the relief surface in the **Max Ramp Length (L)** box.
- Type the minimum distance that you want the cutting tool to zigzag across the relief surface in the **Min Ramp Length (Lmin)** box.
- If you want to define the height at which the ramping moves start, click to select the **Ramp Start Height (S)** option , and then type a value in the box beneath it. If you do not define the **Ramp Start Height (S)** here, the **Safe Z** level is used.

For more details, see "Overview" on page 403.

16. Type a name for the toolpath in the **Name** box.

17. You can now specify when you want to calculate the toolpath:

- If you want to calculate the toolpath now, click on the **Now** button. The **Offsetting Contours** dialog box is displayed while ArtCAM Pro calculates the toolpath:

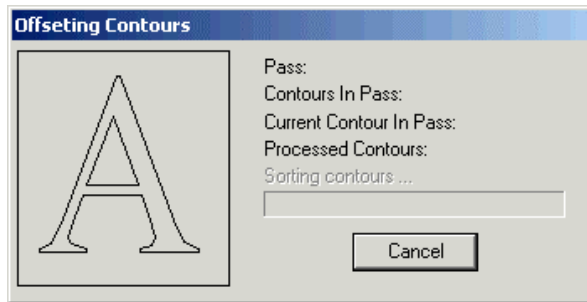

A dark red line represents the machining passes used to profile the selected vector object. It is drawn either inside or outside of its boundary, according to the **Profile Side** that you had selected. A circle marking the current start position is drawn on the toolpath preview. For details, see "Changing the Start Position" on page 533.

The toolpath preview is not shown if the **Create 2D Preview** option is deselected .

You can now simulate the toolpath. For details, see "Simulating Toolpaths" on page 567.

- If you want to calculate the toolpath as part of a batch of toolpaths at a later time, click on the **Later** button. For details, see "Creating a Single Copy" on page 512 and "Calculating a Batch of Toolpaths" on page 549.

18. Click on the **Close** button to return to the **Toolpaths** Home page.

If you want to add bridges to the 3D Cut Out toolpath, see "Adding Bridging" on page 528.



If you want to set the machining order of the 3D Cut Out toolpath, see "Setting the Machining Order" on page 537.

## 3D Rest Machining

Rest (as in 'rest of material') Machining allows you to find all of the areas of a relief that cannot be machined based on one tool size, and then machine only these areas with another, smaller tool.

ArtCAM Pro compares the relief representing a finished model with simulated toolpath data, and then creates vector objects in the shape of the areas of the relief that these toolpaths fail to machine. A *Machine Relief* toolpath strategy can then be applied to some or all of these vector objects to improve the overall surface finish of the manufactured model. For details, see "Machine Relief" on page 481.

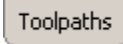
To rest machine a relief:

1. Click on the **Toolpaths** tab  to display the **Toolpaths** Home page.
2. Click on the **3D Rest Machining** button  in the **3D Toolpaths** area to display the **3D Rest Machining** page.
3. In the **Area To Rest Machine** area, select the area of the relief that you want to machine:
  - **Complete Relief** – This option instructs ArtCAM Pro to distinguish the differences between the toolpath simulation and the existing relief, and then identify them for machining purposes.

For example, a teddy bear relief looks as follows:

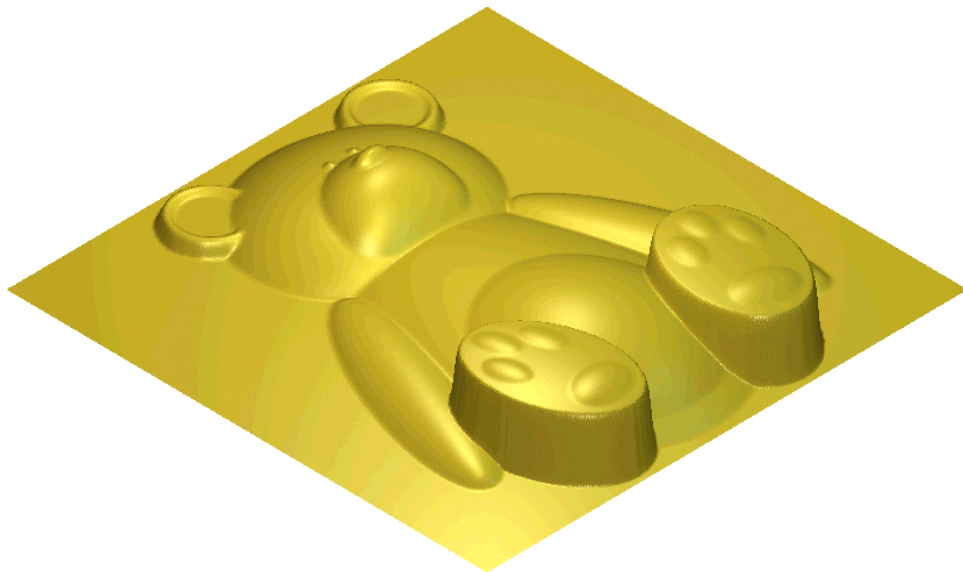

- **Area Under Selected Vectors** – This option instructs ArtCAM Pro to distinguish the differences

between the toolpath simulation and the relief underlying the currently selected vector objects, and then identify them for machining purposes. For details, see "Selecting Vectors" in the Working with Vectors chapter.

4. In the **Identify Areas Already Machined By...** area, click to select the method you want to use to identify the unmachined areas of the current relief:
  - **Simulating All Toolpaths** – This option instructs ArtCAM Pro to simulate all calculated toolpaths and then compare the result against the relief to identify its unmachined areas.

In our example, all three toolpaths used to machine the teddy bear relief are simulated. These appear in the **3D View** window as follows:

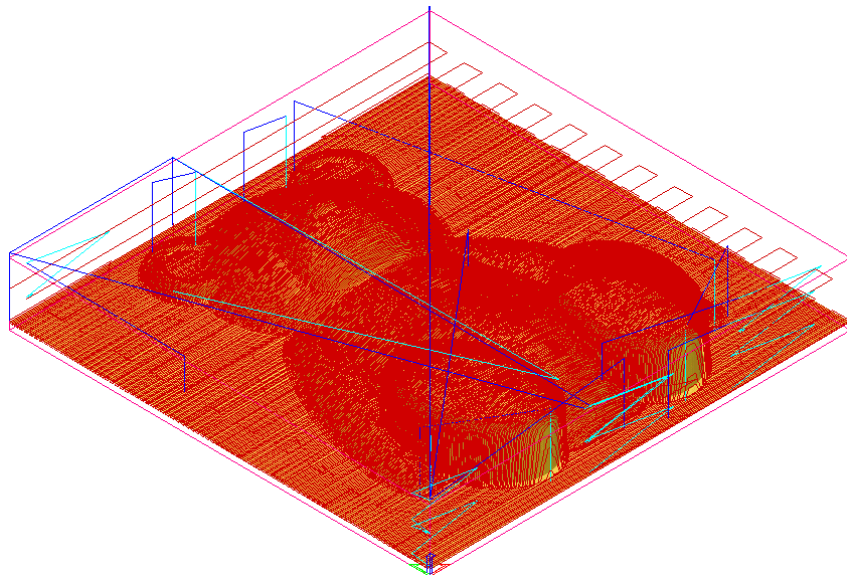

- **Simulating the Last Toolpath** – This option instructs ArtCAM Pro to simulate the last calculated toolpath and then create a model of the unmachined areas of the relief.
  - **Using the Current Simulation** – This option instructs ArtCAM Pro to use the existing toolpath simulation shown in the **3D View** window to identify the unmachined areas of the relief.
5. After simulating a toolpath, you may notice small areas of material, or 'cusps', remain in the model as a consequence of a machining tool's geometry or the stepover used between machining passes. In the **Cusp Tolerance** box, type the

height at which you want ArtCAM Pro to ignore any existing 'cusps' as areas of the model that require additional machining.

6. In the **Layer for rest boundaries** box, type the name of the layer in which you want ArtCAM Pro to create the vector objects representing the unmachined areas of the relief.



---

**Note:** If the **Layer for rest boundaries** box is empty, the vector objects will be created on the currently selected layer. For details, see "Selecting a Layer" in the Working with Models chapter.

---

7. Click on the **Create Boundaries** button to calculate the unmachined areas of the relief from the toolpath simulation, and then create vector objects representing these areas. The simulated toolpaths are displayed in the **3D View** window.
8. Press the **F2** key on your keyboard to display the vector objects representing the unmachined areas of the relief in the **2D View** window.

In our example, ArtCAM Pro identifies unmachined areas around the feet and ears in the teddy bear relief, as shown below:

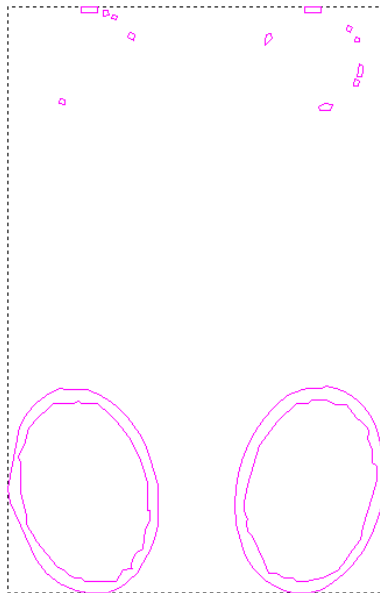

9. Click on the **Close** button to return to the **Toolpaths** Home page.

You are now ready to apply a *Machine Relief* toolpath to the vector objects representing the unmachined areas. This toolpath will improve

the overall surface finish of the relief during the manufacturing process. For details, see "Machine Relief" on page 481.

---

## Managing and Modifying Toolpaths

You can use the **Toolpaths** Home page to modify and manage the toolpath strategies that you are using.

You can modify or manage a toolpath strategy in the following ways:

- Merge a selection of calculated toolpaths into a single toolpath. For details, see "Merging Toolpaths" on page 521.
- Set the order in which the individual toolpaths selected for merging will be machined. For details, see "Creating a Single Copy" on page 512, "Creating a Block Copy" on page 515 and "Merging Toolpaths" on page 521.
- Transform one or more calculated toolpaths. For details, see "Transforming Toolpaths" on page 510.
- Make a single copy of one or more calculated toolpaths. For details, see "Creating a Single Copy" on page 512.
- Make multiple copies of one or more calculated toolpaths in a grid format. For details, see "Creating a Block Copy" on page 515.
- Set the machining order in all toolpaths that involve profile passes. For details, see "Setting the Machining Order" on page 537.
- Adjust the machining parameters of a tool both during and after the toolpath creation. For details, see "Adjusting the Machining Parameters of a Tool" on page 540.
- Save a toolpath. For details, see "Saving a Toolpath" on page 543.
- Edit toolpath settings. For details, see "Editing a Toolpath" on page 545.
- Delete a toolpath or toolpath group. For details, see "Deleting Toolpaths" on page 546.
- Calculate a toolpath by itself or as part of a batch. For details, see "Calculating a Single Toolpath" on page 548 and "Calculating a Batch of Toolpaths" on page 549.

- Create a **Toolpath Summary** and calculate the estimated machining time. For details, see "Using a Toolpath Summary" on page 550.
- Add to, edit or delete the tools within the **Tool Groups Database**. "Using the Tool Groups Database" on page 554.
- Adjust the **Material Setup**. For details, see "Adjusting the Material Setup" on page 562.
- Delete the material.. For details, see "Deleting the Material" on page 564.
- Save a toolpath as a template. For details, see "Creating a Toolpath Template" on page 564.
- Load a toolpath template. For details, see "Loading a Toolpath Template" on page 565.
- Set the toolpath order. For details, see "Setting the Toolpath Order" on page 567.

## Selecting Toolpaths

You can manipulate calculated 2D or 3D toolpaths in the same way as you would vector objects in ArtCAM Pro.

You can transform, copy or edit profile passes within a toolpath, provided that a **2D Preview** was created during the calculation process. Toolpath previews are shown in the **2D View** window only and are dark red.

To select a toolpath preview from the **2D View** window:

1. Make sure that you are in **Select Vectors** mode . For details, see "Selecting Vectors" in the Working with Vectors chapter.
2. Click to select the preview of the toolpath that you want to use. The selected toolpath preview turns blue and is surrounded by a bounding box.

For example, the preview of a Profiling toolpath is shown below:

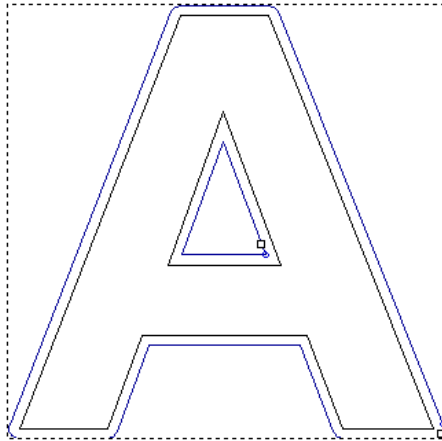

---

**Note:** You can set the default colour of a selected toolpath preview using the **ArtCAM Options** page. For details, see "Managing ArtCAM Pro's Preferences" in the ArtCAM Pro Layout chapter.

---

To select more than one toolpath preview from the **2D View** window:

1. Make sure that you are in **Select Vectors** mode . For details, see "Selecting Vectors" in the Working with Vectors chapter.
2. You can now use either of the following methods to select more than one toolpath preview:
  - Click and drag to form a bounding box around the previews of the toolpaths that you want to use. The selected toolpath previews are blue and surrounded by a bounding box.
  - Hold down the **Shift** key on your keyboard, and then click to select each of the toolpath previews that you want to use. The selected toolpath previews are blue and surrounded by a bounding box.

You can merge, edit, save, delete, calculate, create a template or adjust the machining parameters of a tool using the toolpaths listed on the **Toolpaths** Home page.

To select a toolpath listed on the **Toolpaths** Home page:



1. Click on the name of the tool. The tool name is highlighted in blue.

## Transforming Toolpaths

You can move and mirror a calculated 2D or 3D toolpath.

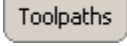

To transform a calculated toolpath:

1. Click on the **Toolpaths** tab  to display the **Toolpaths** Home page.
2. Click on the **Toolpath Transform** button  in the **Toolpath Operations** area to display the **Toolpath Transform** page. A list of all calculated toolpaths is displayed.



---

**Note:** You can also display the **Toolpath Transform** page if you right-click on a selected 2D toolpath preview to display the Toolpath Editing menu, and then click on the **Transform Toolpath** option

---

3. Select which of the toolpaths you want to transform:
  - **Selected** – Click on this radio button  if you want to transform a single selected toolpath only.  
To select a toolpath from the list, click on its name. It is highlighted in blue.  
If the toolpath makes use of more than one tool, click on the toolpath name to transform all of its machining passes or on an individual tool name if you want to transform a single machining pass.
  - **All Visible** – Click on this radio button  if you want to transform all of the selected toolpaths listed on the page.  
If you want to transform a 2D or 3D toolpath, its **Show In 3D** option must be selected .  
If you do not want to transform a 2D or 3D toolpath, its **Show In 3D** option must be deselected .
4. If you want to move the selected toolpath(s):
  - Type the distance by which you want to move the selected toolpath(s) along the X-axis in the **X** box.
  - Type the distance by which you want to move the selected toolpath(s) along the Y-axis in the **Y** box.
  - Type the distance by which you want to move the selected toolpath(s) along the Z-axis in the **Z** box.

5. If you want to keep a copy of all selected toolpaths in their original position, click to select the **Preserve Originals** option .
6. If you want to mirror the selected toolpath(s):
  - Click on the **Mirror X** button to mirror the selected toolpath(s) about the X-axis.
  - Click on the **Mirror Y** button to mirror the selected toolpath(s) about the Y-axis.
7. Click on the **Apply** button to transform the selected toolpath(s).
8. Click on the **Close** button to return to the **Assistant's** Home page.

## Copying Toolpaths

You can create a single copy or multiple copies of a calculated toolpath in two regular patterns using the **Toolpath Copy** page.



There are two options available for copying toolpaths on the **Copy Toolpath** page:

- **Copy** – This option allows you to make a single copy of a selected toolpath, and paste it to a specific position. For details, see "Creating a Single Copy" on page 512.
- **Block Copy** – This option allows you to make several copies of a selected toolpath in a grid format. For details, see "Creating a Block Copy" on page 515.

### Creating a Single Copy

You can create a single copy of a calculated toolpath.

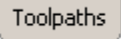
To copy a toolpath:

1. Click on the **Toolpaths** tab  to display the **Toolpaths** Home page.
2. Click on the **Toolpath Copy** button  in the **2D Toolpaths** area to display the **Toolpath Copy** page.



---

**Note:** You can also display the **Toolpath Copy** page if you right-click on a selected 2D toolpath preview to display the Toolpath Editing menu, and then click on the **Copy Toolpath** option

---

3. Click on the **Copy** radio button  to display its settings.
4. Select which of the toolpaths you want to copy:
  - **Selected** – Click on this radio button  if you want to copy a single toolpath only.

To select the toolpath from the list, click on its name. It is highlighted in blue.

If the toolpath makes use of more than one tool, click on the toolpath name to copy all of its machining passes or on an individual tool name if you want to copy a specific machining pass.

For example, a selected 2D Area Clearance toolpath is shown below:

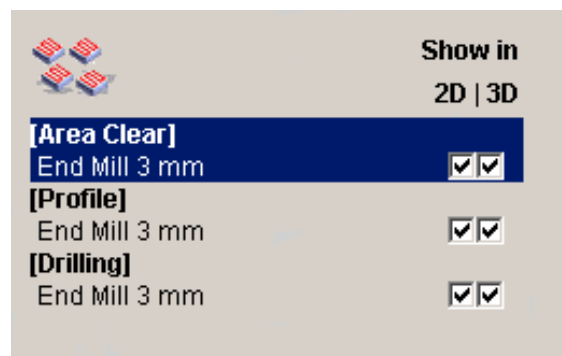

- **All Visible** – Click on this radio button  if you want to copy all of the selected toolpaths in the list.

If you want to copy a 2D or 3D toolpath, its **Show In 3D** option must be selected .

If you do not want to copy a 2D or 3D toolpath, its **Show In 3D** option must be deselected .

If we were to copy only the Profiling and 2D Area Clearance toolpaths as listed above, the Drilling toolpath's **Show In 3D** option must be deselected, as shown:

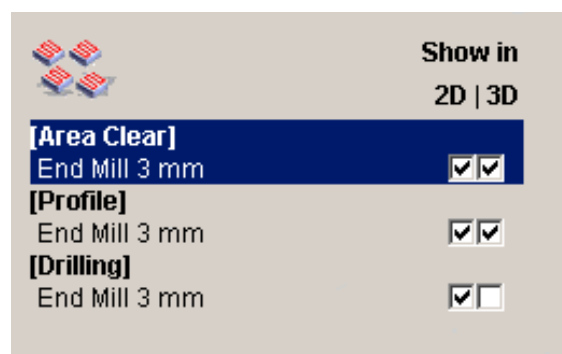

5. Define the distance you want to set between the selected toolpath and its copy along the X-axis in the **X Offset** box.

The X and Y offsets that you define set the distance at which each copy of a toolpath will be created from the bottom left corner of the previous copy in the block.



---

**Note:** You can set the offset distance between each copy using a positive or negative value. To create a copy to the right of and above the selected toolpath, type positive values in the offset boxes e.g. 90. To create a block of copies to the left of and below of the selected toolpath, type negative values in the offset boxes e.g. -90.

---



6. Define the distance you want to set between the selected toolpath and its copy along the Y-axis in the **Y Offset** box.
7. If you have selected a 3D toolpath, define the distance you want to set between the selected toolpath and its copy along the Z-axis in the **Z Offset** box.



---

**Note:** If you have selected a 2D toolpath, the **Z Offset** box is greyed-out.

---

8. If you want to merge the copy with its original toolpath:
  - First, prioritise the toolpaths using the  and  arrows. Click to select the name of the toolpath in the list that you want to prioritise, and then on the appropriate arrow to set its position in the list. The order in which the toolpaths are listed on the page reflects the machining order of the toolpaths that make up the merged toolpath. The toolpath at the top of the list is the first to be machined, and so on.
  - Next, click to select the **Merge Results** option . A **Name** box appears.
  - Finally, type a name for the new toolpath in the **Name** box.

9. Click on the **Apply** button to create the new toolpath.  
In our example, the copied toolpath appears in the **2D View** window, as shown below:

*Before...*

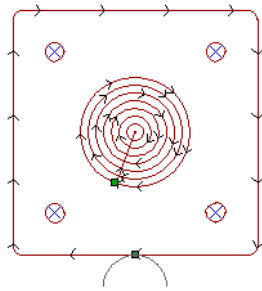

*After...*

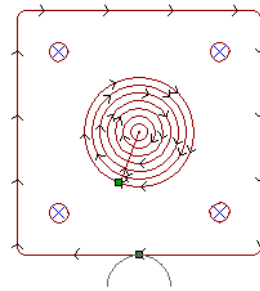

The copied toolpath is named *Area Clear 1* by default in the list of toolpaths on the page.

10. Click on the **Close** button to return to the **Assistant's** Home page.

## ***Creating a Block Copy***

When producing multiple copies of a selected toolpath in a grid format, ArtCAM Pro allows you to set the distance and the direction at which each copy of the selected toolpath will be created from any of the four edges of the previous copy in the block.



---

**Warning:** When creating a block copy of an Area Clearance toolpath, make sure that the defined gap or offset between each copy in the block is greater than the diameter of the cutting tool. Otherwise, the allowance will be insufficient for the tool to clear each area without overlapping.

---



---

**Note:** You cannot block copy a toolpath without using a toolpath preview. Make sure that the **Create 2D Preview** option is always selected  when you create a toolpath.

---

In the following example, a block copy of a merged toolpath is shown:

*Before...*

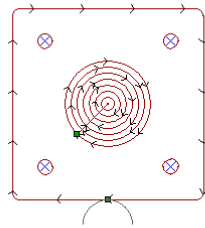

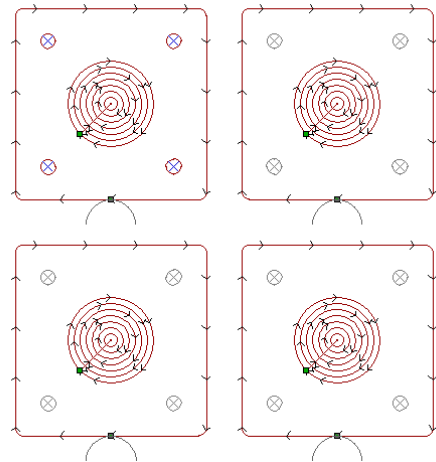

*After...*

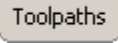

For further information on merged toolpaths, see "Merging Toolpaths" on page 521.

To create a block of copies in a grid format:

1. Click on the **Toolpaths** tab  to display the **Toolpaths** Home page.
2. Click on the **Toolpath Copy** button  in the **2D Toolpaths** area to display the **Toolpath Copy** page.



---

**Note:** You can also display the **Toolpath Copy** page if you right-click on a selected 2D toolpath preview to display the Toolpath Editing menu, and then click on the **Copy Toolpath** option

---

3. Click on the **Block Copy** radio button  to display its settings.
4. Select which of the toolpaths you want to block copy:
  - **Selected** – Click on this radio button  if you want to block copy a single toolpath only.

To select the toolpath from the list, click on its name. It is highlighted in blue.

If the toolpath makes use of more than one tool, click on the toolpath name to block copy all of its machining passes or an individual tool name if you want to block copy a specific machining pass.

- **All Visible** – Click on this radio button  if you want to block copy all of the toolpaths listed on the page.

If you want to block copy a 2D or 3D toolpath, its **Show In 3D** option must be selected .

If you do not want to block copy a 2D or 3D toolpath, its **Show In 3D** option must be deselected .

For example, the **Show In 3D** option for all three toolpaths is selected, meaning that all of the listed toolpaths are visible, as shown below:

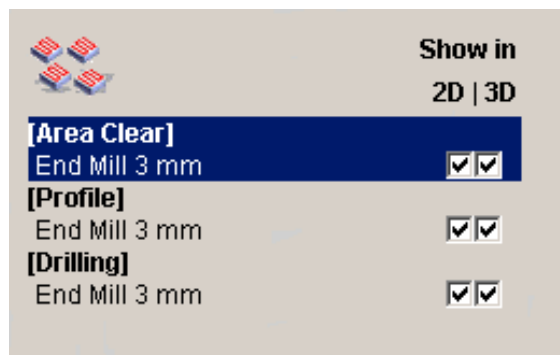

5. Select the method you want to use to set the distance between each copy within the block:

*Distances are offsets...*

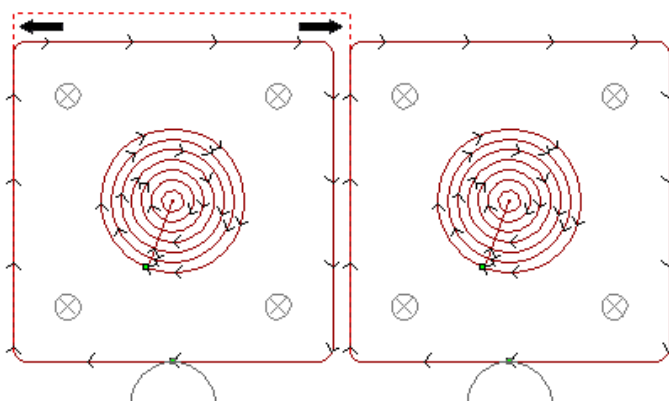

*Distances are gaps...*

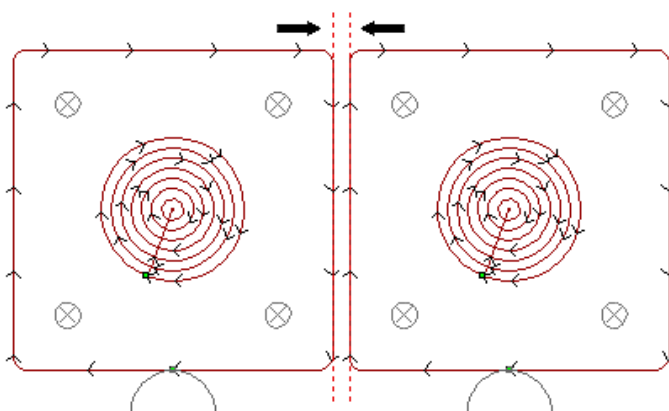

- The **Distances are offsets** option allows you to set the distance at which each copy of a toolpath will be created from the bottom left corner of the previous copy in the block. The overall distance between each copy equates to the height or width of the vector plus the gap. The **Distances are offsets** radio button  is selected by default.
- Click on the **Distances are gaps** option allows you to set the distance and direction at which each copy of a toolpath will be created from any of the four edges of the previous copy in the block. The overall distance between each copy equates to the defined gap. Click on the **Distances are gaps** radio button  to display its settings.

If you have selected the **Distances are offsets** option:

- First, define the distance you want to set between each copy along the X-axis in the **X Offset** box.
- Next, define the distance you want to set between each copy along the Y-axis in the **Y Offset** box.





---

**Note:** You can set the offset distance between each copy using a positive or negative value. To create a block of copies to the right of and above the selected vector object, type positive values in the offset boxes e.g. 90. To create a block of copies to the left of and below of the selected vector object, type negative values in the offset boxes e.g. -90.

---

- Finally, define the total number of copies by defining the number of rows and columns you want to create in the **Number of Rows** and **Number of Columns** boxes.

If you have selected the **Distances are gaps** option:

- First, define the width of the gap between each subsequent copy of the selected vector object along the X-axis in the **X Gap** box.
- Next, define the width of the gap between each subsequent copy of the selected vector object along the Y-axis in the **Y Gap** box.
- Now, define the total number of copies by typing the number of rows and columns you want to create in the **Number of Rows** and **Number of Columns** boxes.
- Finally, set the direction in which you want to create the block of copies:

The **Copy From Left To Right** button  allows you to copy the selected vector object to the right along the X-axis.

The **Copy From Right To Left** button  allows you to copy the selected vector object to the left along the X-axis.



---

**Note:** You can toggle between the **Copy From Left To Right** and **Copy From Right To Left** direction by clicking on whichever button is currently displayed.

---



The **Copy From Bottom To Top** button allows you to copy the selected vector object upwards along the Y-axis.





The **Copy From Top To Bottom** button allows you to copy the selected vector object downwards along the Y-axis.



---

**Note:** You can toggle between the **Copy From Bottom To Top** and **Copy From Top To Bottom** direction by clicking on whichever button is currently displayed.

---

6. If you want to merge all selected toolpaths and their block copies into a single toolpath:
  - First, prioritise the toolpaths using the  and  arrows. Click to select the name of the toolpath in the list that you want to prioritise, and then on the appropriate arrow to set its position in the list. The order in which the toolpaths are listed on the page reflects the machining order of the toolpaths that make up the merged toolpath. The toolpath at the top of the list is the first to be machined, and so on.
  - Next, click to select the **Merge Results** option . A **Name** box appears.
  - Finally, type a name for the new merged toolpath in the **Name** box.

In our example, the merged toolpath is named *Merged*.

7. Click on the **Apply** button to create the new block of toolpaths.

In our example, the block of copied toolpaths appears in the **2D View** as shown below:

Before...

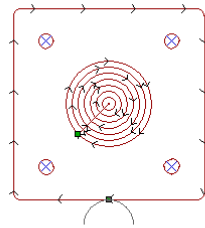

After...

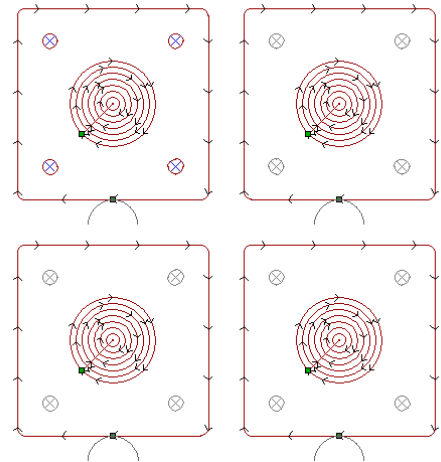

The *Merged* toolpath replaces all of the individual toolpaths previously listed on the page:

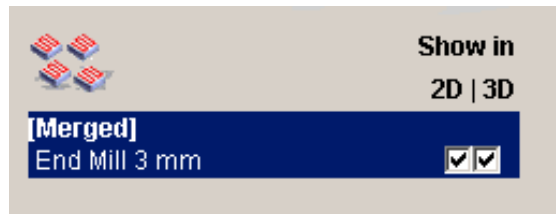

8. Click on the **Close** button to return to the **Assistant's** Home page.

## Merging Toolpaths

You can merge different calculated toolpaths into one, avoiding the need for the tool to repeatedly return to the Home position when machining them separately. Merging toolpaths saves machining time and also reduces wear on cutting tools.



**Warning:** Once a selection of toolpaths has been merged, you cannot ungroup them or edit the group. You should save the model before merging any toolpaths or select the **Preserve original toolpaths** option  on the **Toolpath Merge** page. This way, if any mistakes are made, you can return to the toolpaths in their original state. For details on saving a model, see "Saving a Model" in the Working with Models chapter.

In the example below, you can see the tool movement in three separate toolpaths, each of which uses a 3mm End Mill (1/8 Inch End Mill). After all three of the toolpaths have been merged, you can see that the number of rapid moves made between the **Home** position and the

**Safe Z** level is reduced significantly. For further information on tool movement, see "Viewing a Toolpath" on page 573.

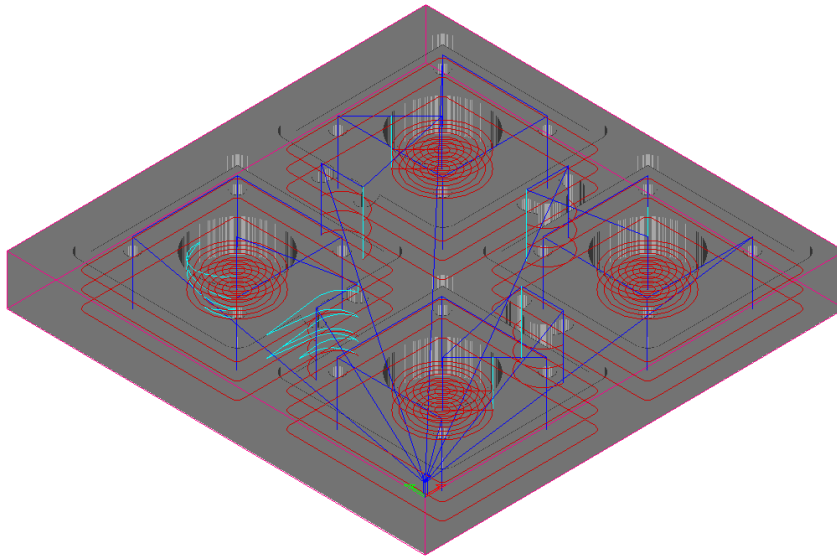

*Separate Toolpaths...*

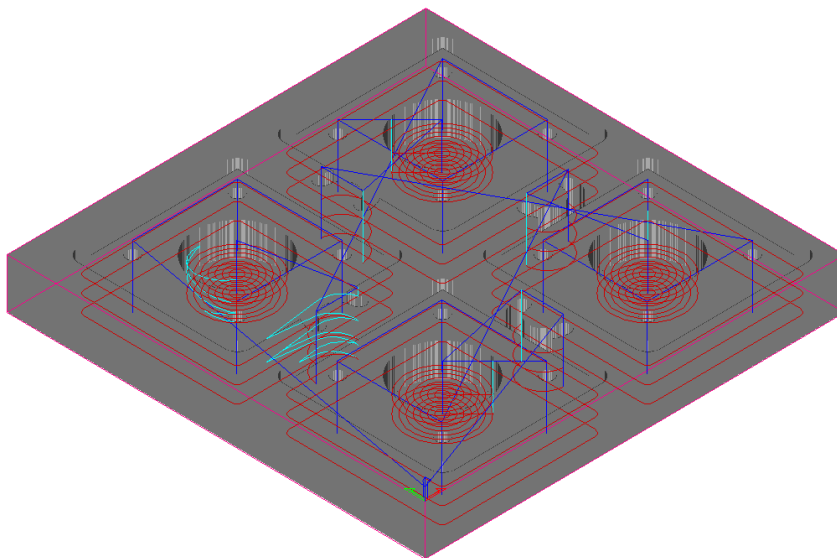

*Merged Toolpath...*



To merge a selection of toolpaths:

1. Click on the **Toolpaths** tab  to display the **Toolpaths** Home page.
2. Click on the **Toolpath Merge** button  in the **2D Toolpaths** area to display the **Toolpath Merge** page.





---

**Note:** You can also display the **Toolpath Merge** page if you right-click on a selected 2D toolpath preview to display the Toolpath Editing menu, and then click on the **Merge Toolpaths** option

---

3. Make sure that only the toolpaths that you want to merge are selected:
  - If you want to merge a 2D or 3D toolpath, its **Show In 3D** option must be selected .
  - If you do not want to merge a 2D or 3D toolpath, its **Show In 3D** option must be deselected .
4. In the **Merging Order** area, select the order in which you want the merged toolpaths to be machined:
  - **As List** - Click on this radio button  if you want the toolpaths to be machined in the order in which they are listed on the page.

You can prioritise the toolpaths using the  and  arrows. Click to select the name of the toolpath in the list that you want to prioritise, and then on the appropriate arrow to set its position in the list. The toolpath at the top of the list is the first to be machined, and so on.
  - **Automatic** - Click on this radio button  if you want ArtCAM Pro to calculate the order in which the toolpaths are machined, finding the shortest route between them.
5. If you want to keep a copy of the toolpaths in their original state, click to select the **Preserve original toolpaths** option .
6. Type a name for the merged toolpath in the **Name** box.
7. Click on the **Calculate** button to merge the selected toolpaths into a single toolpath.

A progress bar appears beneath the **2D View** window indicating the progress made in merging the toolpaths.
8. Click on the **Close** button to return to the **Assistant's** Home page.

## Creating Toolpath Panels

You can machine a design larger than the bed-size of your router, or larger than the panels of material that are currently available. ArtCAM Pro divides calculated toolpaths into sections so that you can machine separate panels of material one by one and then piece them all together, or machine a single panel of material larger than the router's

bed-size in sections, repositioning the panel on the router bed until all sections have been machined.





---

**Warning:** To use toolpath panelling, the job origin must be set to the bottom left corner of the model. For details, see "Creating a Model" in the Working with Models chapter.

---

To create toolpath panels:

1. Click on the **Toolpaths** tab  to display the **Toolpaths** Home page.
2. Make sure that all of the previews of the toolpaths that you want to divide into panels are shown in the **2D View** window. Click to select the **Show In 2D** option next to any hidden toolpaths to make them visible .
3. Click on the **Toolpath Panelling**  button in the **Toolpath Operations** area to display the **ArtCAM Toolpath Panelling** page.
4. In the **Standard Panel Size** area, define the width and height of the available panels of material, or the size of the router-bed (whichever maybe the limiting factor in the job), using the **Width** and **Height** boxes, and then click on the **Update Panels** button.

If you want to allow a toolpath to extend beyond the top and right edges of a panel of material, define the maximum overcut distance in the **Overcut Distance** box.

Guidelines are drawn in the **2D View** to represent the size of each panel or the router-bed itself. For details on using guidelines, see "Using Guidelines" in the ArtCAM Pro Layout chapter.



---

**Warning:** Make sure that the dimensions of your router allow you to drag the panels of material you want to use across its bed.

---

For example, you might only be able to acquire panels of material with a height and width of 500 mm (19.7").

5. In the **Panel Numbers** area, use the buttons to set the order in which the panels are numbered:
  - Click on the  button to number the panels vertically.

- Click on the  button to number the panels horizontally.

In our example, the calculated toolpaths are divided into six sections and numbered vertically. These appear as follows:

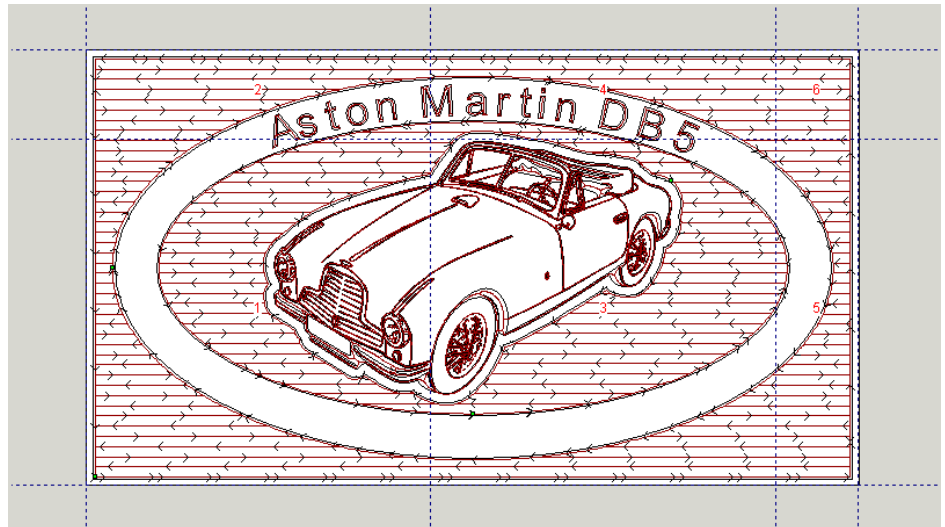

In the **Panel Size** area, you can see the dimensions of each panel and the required offset during the machining process. The offset is the distance along which the panel must be pulled across the router-bed, or positioned on it from the job origin, in order to machine the complete design.

In our example, the overall job dimensions are 1120 mm (44.1") x 630 mm (24.8"). The available panels of material measure at 500 mm (19.7") x 500 mm (19.7"). This means that the job requires six panels of material.

6. Whenever possible, you should contain sections of detail in the toolpath to a single panel to preserve the integrity of the complete design when each of the machined panels are finally joined together. To do so, you should edit the guidelines drawn to represent each panel as required. For details on editing guidelines, see "Using Guidelines" in the ArtCAM Pro Layout chapter.





---

**Note:** When editing guidelines it is important to remember that each toolpath panel remains equal to or less than the physical size of the panels of material available or the router-bed used when machining your design.

---

In our example, the guidelines have been repositioned so that the text in the design is machined across as few panels as possible and so that each word is undivided.

7. If you want to print the data required to machine the toolpath panels accurately:
  - First, click on the **Display Panel Info** button to display the **ArtCAM Toolpath Panelling** window. This contains an image of the toolpaths when divided into panels and the data for machining the job.
  - If you want to include the toolpath summary data along with the panel information, click to select the **Include Toolpath Summary** option . For further information, see "Using a Toolpath Summary" on page 550.
  - Next, scroll to the bottom of the **ArtCAM Toolpath Panelling** window, and then click on the **Print** button. If you have more than one printer installed, the standard windows **Print** dialog box appears. Select the printer on which you want to print the panel measurements, and then click on the **OK** button.
8. Click on the **3D View** button  in the **2D View** toolbar to display the **3D View** window.
9. In the **3D View Toolpath Drawing** area, you can select the panel(s) that you want to view in the **3D View** window:
  - Click on the **Display All** radio button  if you want to display all panels.
  - Click on the **Display Selected** radio button  if you want to display only a selection of panels. This option activates the **Panel Number** list box and the options beneath.

In this instance, click on the **Panel Number** list box, and then on the panel that you want to display. If you want to display the selected panel about the job origin, click on the **At Origin** radio button . If you want to display the selected panel, as it will appear in the overall job design, click on the **In Finished Job** radio button .



*Panel 3 at Origin...*

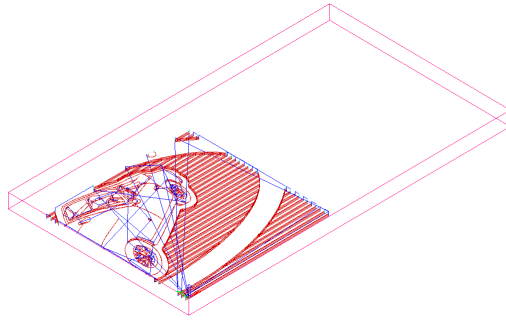

*Panel 3 in Finished Job...*

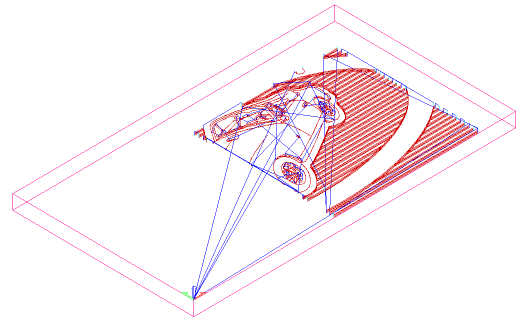

10. If you want to save the panelled toolpaths, click on the **Save** button to display the **Save Toolpaths** dialog box. For details on how to use the **Save Toolpaths** dialog box, see "Saving a Toolpath" on page 543. Each panel can be saved as a separate toolpath file with *\_px* appended to its name, where *x* is equal to the panel number.
11. Click on the **Close** button to return to the **Toolpaths** Home page.

## Editing a Profile Pass

You can edit any profile pass within a selected toolpath using the **Profile Options** page.





---

**Note:** You cannot edit a profile pass in a toolpath without using a toolpath preview. Make sure that the **Create 2D Preview** option is always selected  when you create a toolpath.

---

To display this page in the **Assistant** window:

1. Select the toolpath preview containing the profile pass that you want to edit. For details, see "Selecting Toolpaths" on page 509.
2. Click on the **Toolpaths** tab  to display the **Toolpaths** Home page.
3. Click on the **Profile Options** button  in the **2D Toolpaths** area.

There are three options available for editing a profile pass on the **Profile Options** page, but the settings for only one of these options can be displayed on the page at any one time:

- **Bridges** – This option allows you to add bridges, or tabs, to the selected profile pass. For details, see "Adding Bridging" on page 528.
- **Start Point** – This option allows you to change the position of the start point in the selected profile pass. For details, see "Changing the Start Position" on page 533.
- **Leads** – This option allows you to add lead moves to the selected profile pass. For details, see "Adding Lead Moves" on page 535.

## Adding Bridging



Bridging is a precautionary measure to prevent a profiled vector object from shifting in the block of material as it is machined.

The cutting tool used to profile vector objects lifts slightly in the Z direction about the position of each bridge, leaving small tabs that hold the vector object in position during machining. The machined vector object can then be gently snapped out from the block of material.





---

**Note:** You can add bridges to any profile pass within a calculated toolpath, provided that a **2D Preview** was created during the calculation process. The toolpaths that involve profile passes are **2D Profiling**, **Bevel Carving**, **Machine Along Vector**, and **Inlay** (Female – Hole and Male – Straight).

---

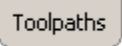
To add bridging to a profile pass:

1. Click on the **Select Vectors** button  in the **Vector Editing** area of the **Assistant's** Home page. For details, see "Selecting Vectors" in the Working with Vectors chapter.
2. In the **2D View** window, click to select the preview of the profile pass to which you want to insert bridges. By default, the toolpath preview turns blue. For details, see "Selecting Toolpaths" on page 509.
3. Click on the **Toolpaths** tab  to display the **Toolpaths** Home page.

4. Click on the **Profile Options** button  in the **2D Toolpaths** area to display the **Profile Options** page.
5. Click on the **Bridges** option  to display the bridging settings on the page.
6. Define the length of each bridge in the **Bridge Length** box.
7. Define the thickness of each bridge in the Z direction in the **Bridge Thickness** box.
8. If you want to insert bridges with a triangular cross-section, and without any associated retract or plunge moves, click to select the **3D Bridges** option .

Three-dimensional bridges produce a raised shape, typically a triangle or pyramid, in a machined model. This shape reduces the cross-section and the overall surface area of a bridge, and without any associated retract and plunge moves dwell marks are prevented.

*Default Bridges...*

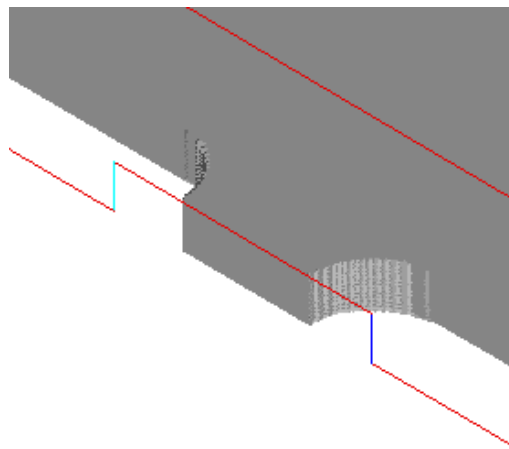

*3D Bridges...*

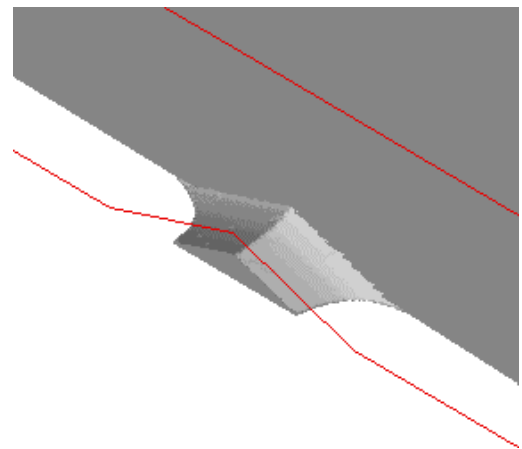

9. To set how the bridges are inserted into the selected profile pass, click on either of the **Add Bridges To Profiles** radio buttons :
  - **Constant Number** – Click to select this option to insert a specific number of evenly spaced bridges into the selected profile pass.

If you select this option, define the number of bridges you want to create in the **Number** box.

- **Constant Spacing** – Click to select this option to insert the bridges at a specific distance apart from each other into the selected profile pass.

If you select this option, first define the distance between bridges from the centre of each bridge, in the **Distance** box.

Next define the minimum number of bridges you want to insert into the selected profile pass, irrespective of the distance you have set between them, in the **Min. Number** box. If you want to limit the number of bridges created, define the maximum number in the **Max. Number** box.

10. Click on the **Create Bridges** button to add the bridges to the selected profile pass.
11. Click on the **Close** button to return to the **Assistant's** Home page.

## ***Editing Bridging***



You can edit the bridging that you have added to a profile pass in several ways. You can:

- Insert new bridges. For details, see "Inserting a Bridge" on page 530.
- Delete an individual or all existing bridges. For details, see "Deleting Bridges" on page 531.
- Change the length of individual or all existing bridges. For details, see "Changing the Length of a Bridge" on page 532.
- Move bridges into a new position on the profile pass. For details, see "Moving a Bridge" on page 533.

## **Inserting a Bridge**



You can add an individual bridge to any place in a selected profile pass. To do so:

1. Click on the **Select Vectors** button  in the **Vector Editing** area of the **Assistant's** Home page. For details, see "Selecting Vectors" in the Working with Vectors chapter.
2. In the **2D View** window, click to select the preview of the profile pass to which you want to insert bridges. By default, the toolpath preview turns blue. For details, see "Selecting Toolpaths" on page 509.

3. Click on the **Toolpaths** tab  to display the **Toolpaths** Home page.
4. Click on the **Profile Options** button  in the **2D Toolpaths** area to display the **Profile Options** page. The bridging settings are displayed on the page.
5. Move the cursor over the position in the profile pass where you want to insert the centre-point of the new bridge.
6. Press the **I** key on your keyboard or double-click the left mouse button to insert the new bridge. The new bridge is the same length and thickness as all of the other bridges in the selected profile pass.

## Deleting Bridges



You can delete any or all of the bridges in a selected profile pass. To do so:

1. Click on the **Select Vectors** button  in the **Vector Editing** area of the **Assistant's** Home page. For details, see "Selecting Vectors" in the Working with Vectors chapter.
2. In the **2D View** window, click to select the preview of the profile pass containing the bridges that you want to delete. By default, the toolpath preview turns blue. For details, see "Selecting Toolpaths" on page 509.
3. Click on the **Toolpaths** tab  to display the **Toolpaths** Home page.
4. Click on the **Profile Options** button  in the **2D Toolpaths** area to display the **Profile Options** page.
5. If you want to delete an individual bridge, move the cursor over the bridge you are removing and then use either of the following methods:
  - Press the **D** key on your keyboard. You must have clicked at least once in the **2D View** window before you can do this.
  - Double-click on the bridge itself.

If you want to delete all of the bridges that are currently in the selected profile pass, click on the **Delete All Bridges** button.

## Changing the Length of a Bridge

You can change the length of any or all of the bridges in a selected profile pass. To do so:

1. Click on the **Select Vectors** button  in the **Vector Editing** area of the **Assistant's** Home page. For details, see "Selecting Vectors" in the Working with Vectors chapter.
2. In the **2D View** window, click to select the preview of the profile pass containing the bridges that you want to extend or reduce. By default, the toolpath preview turns blue. For details, see "Selecting Toolpaths" on page 509.
3. Click on the **Toolpaths** tab  to display the **Toolpaths** Home page.
4. Click on the **Profile Options** button  in the **2D Toolpaths** area to display the **Profile Options** page. The bridging settings are displayed on the page.



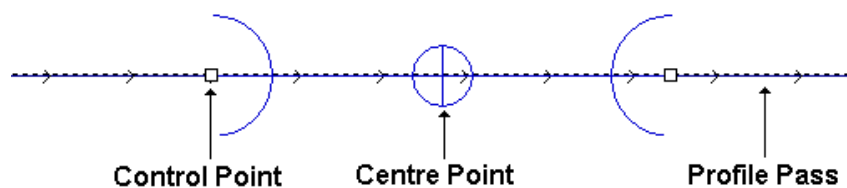

Using the **Zoom In Tool** button , zoom in on the bridge that you want to extend or reduce and then click on its centre-point to select it. For details on using the **Zoom In Tool**, see "Zoom In Tool" in the ArtCAM Pro Layout chapter. The bridge is blue with a control point at each end:



5. Click and drag either of the control points attached to the bridge to set its new length.
6. If you want all bridges in the selected profile pass to share the new length of this bridge, click on the **Update All Bridges** button.

## Moving a Bridge

You can change the position of an individual bridge on a selected profile pass. To do so:

1. Click on the **Select Vectors** button  in the **Vector Editing** area of the **Assistant's** Home page. For details, see "Selecting Vectors" in the Working with Vectors chapter.
2. In the **2D View** window, click to select the preview of the profile pass containing the bridges that you want to move. By default, the toolpath preview turns blue. For details, see "Selecting Toolpaths" on page 509.
3. Click on the **Toolpaths** tab  to display the **Toolpaths** Home page.
4. Click on the **Profile Options** button  in the **2D Toolpaths** area to display the **Profile Options** page. The bridging settings are displayed on the page.
5. Using the **Zoom In Tool** button , zoom in on the bridge that you want to move and then click on its centre-point to select it. For details on using the **Zoom In Tool**, see "Zoom In Tool" in the ArtCAM Pro Layout chapter.
6. Click and drag on the centre-point to move the bridge along the profile pass into its new position.





## Changing the Start Position

The start position in a profile pass determines the place at which the cutting tool enters the block of material when you are machining a model. The green point (node) surrounded by a blue circle indicates the current start position in the profile pass.

To change the start position relative to a defined reference point:

1. Click on the **Select Vectors** button  in the **Vector Editing** area of the **Assistant's** Home page. For details, see "Selecting Vectors" in the Working with Vectors chapter.
2. In the **2D View** window, click to select the preview of the profile pass in which you want to change the start position.

By default, the toolpath preview turns blue. For details, see "Selecting Toolpaths" on page 509.

3. Click on the **Toolpaths** tab  to display the **Toolpaths** Home page.
4. Click on the **Profile Options** button  in the **2D Toolpaths** area to display the **Profile Options** page.
5. Click on the **Start Point** option  to display the Start Point settings on the page.
6. In the **Reference Point** area, click on one of the four radio buttons  to define the reference point by which you want to set the position of the Start Point in the selected profile pass:

- **Centre of Gravity** – This option sets the reference point in the main mass of the vector object from which the selected toolpath was created.

If you select this option, four radio buttons  are shown in the **Position** area. These indicate the positions available for the Start Point in the selected profile pass relative to the reference point.

You can set the Start Point above, below, left or right of its current position, depending on the cutting direction of the selected profile pass.

- **Centre of Bounding Box** – This option sets the reference point in the centre of the selected profile pass, as defined by the bounding box that surrounds it.

If you select this option, four radio buttons  are shown in the **Position** area. These indicate the positions available for the Start Point in the selected profile pass relative to the reference point.

You can set the Start Point above, below, left or right of its current position, depending on the cutting direction of the selected profile pass.

- **Highest or Lowest X or Y Value** – This option sets the reference point as the position in the selected profile pass with the highest or lowest X or Y value, depending on its cutting direction.



If you select this option, four radio buttons  are shown in the **Position** area. These indicate the positions available for the Start Point in the selected profile pass relative to the reference point.

You can set the Start Point above, below, left or right of its current position, depending on the cutting direction of the selected profile pass.

7. In the **Position** area, click on any of the radio buttons  to select the position of the Start Point in the selected profile pass. Alternatively, you can click on the Start Point in the selected profile pass and drag it into position.
8. Click on the **Apply** button to set the new position of the Start Point.
9. Click on the **Close** button to return to the **Assistant's** Home page.

You can set any point (node) in a selected vector object as the Start Point. For further information, see "Changing the Start Point" in the Working with Vectors chapter. This defines the Start Point position in a toolpath when it is first created.

## ***Adding Lead Moves***

Lead moves are a precautionary measure to prevent dwell marks from appearing on a model at the point at which the tool enters and leaves the block of material when machining a profile pass.

Instead of plunging into the block of material, machining the profile pass and then retracting from it, the tool enters and leaves the block at a specified distance from the start/end of the profile pass. This is either the Start Point in the vector object from which the profile pass was calculated, or in the centre of its longest span.



---

**Note:** You can add lead moves to any profile pass within a calculated toolpath, provided that a **2D Preview** was created during the calculation process. The toolpaths that involve profile passes are **2D Profiling, Bevel Carving, Machine Along Vector**, and **Inlay** (Female – Hole and Male – Straight).

---







---

**Note:** You can also add lead moves to a Profiling toolpath when creating the toolpath itself. For details, see "2D Profiling" on page 407.

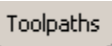
---

To add lead moves to a profile pass:

1. Click on the **Select Vectors** button  in the **Vector Editing** area of the **Assistant's** Home page. For details, see "Selecting Vectors" in the Working with Vectors chapter.
2. In the **2D View** window, click to select the preview of the profile pass in which you want to add lead moves. By default, the toolpath preview turns blue. For details, see "Selecting Toolpaths" on page 509.
3. Click on the **Toolpaths** tab  to display the **Toolpaths** Home page.
4. Click on the **Profile Options** button  in the **2D Toolpaths** area to display the **Profile Options** page.
5. Click on the **Leads** option  to display the lead move settings on the page.
6. If you do want to add a lead-out move to the profile pass, click to select the **Do not Lead Out** option .
7. Define the distance from the profile pass that you want the tool to cut into and retract from the block of material in the **Distance (D)** box.
8. Define the distance from the start/end point in the profile pass that you want the tool to machine over in the **Over Cut (O)** box. This further helps to create a smooth finish.
9. Select how you want the tool to move using either of the radio buttons 
  - **Linear** – Click on this option to instruct the tool to lead into and out of the block of material in a straight-line motion. If you select the **Linear** option, define the angle of the linear lead moves in the **Angle In** and **Angle Out** boxes.

When editing lead moves associated with a profile pass used to machine inside of a defined area, the distance of a linear lead move or the radius of a circular arc move is now considered.

When adjusting the position of a linear lead move, ArtCAM checks to ensure that the distance of the lead move remains within the boundary of the profile

pass. If the current distance of the lead move intersects with the profile pass, its distance will be cropped so that it does not.

When adjusting the position of a circular arc lead move, ArtCAM checks to ensure that the radius of the lead move remains within the boundary of the profile pass. If the current radius of the lead move intersects with the profile pass, the lead move is converted to a linear move instead with a distance that does not.

- **Circular Arc** – Click on this option to instruct the tool to lead into and out of the block of material in an arc motion. If you select this option, define in the radius of the arc you want to use in the **Radius (R)** box.

The value in the **Distance (D)** must be less than or equal to the value in the **Radius (R)** box, otherwise the following message box appears when you attempt to **Apply** the lead moves to the profile pass:

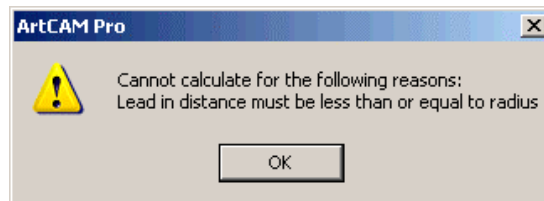

Click on the **OK** button to close the message box.

10. Click on the **Apply** button to add the lead moves.
11. Click on the **Close** button to return to the **Assistant's** Home page.

## Setting the Machining Order

When machining a toolpath that is made up of more than one profile pass, you can set the order in which each of them are machined.



---

**Note:** You can set the machining order in a calculated toolpath, provided that a **2D Preview** was created during the calculation process. The toolpaths that involve profile passes are **2D Profiling**, **Bevel Carving**, **Machine Along Vector**, and **Inlay** (Female – Hole and Male – Straight).



---

To set the order in which the profile passes in a toolpath are machined:

1. Click on the **Select Vectors** button  in the **Vector Editing** area of the **Assistant's** Home page. For details, see "Selecting Vectors" in the Working with Vectors chapter.
2. In the **2D View** window, click to select the preview(s) of the profile pass(es) for which you want to set the machining order. By default, the toolpath preview turns blue. For details, see "Selecting Toolpaths" on page 509.

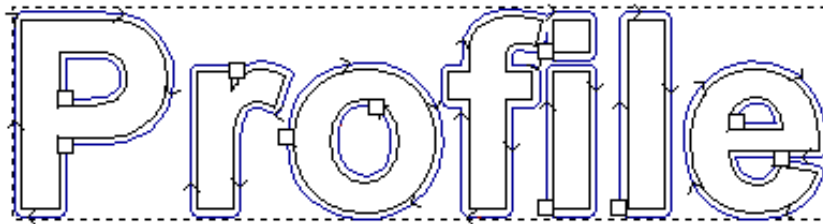
For example, selecting the Profiling toolpath around *Profile* vector text appears as follows:



3. Click on the **Toolpaths** tab  to display the **Toolpaths** Home page.
4. Click on the **Toolpath Ordering** button  in the **2D Toolpaths** area to display the **Toolpath Ordering** page. Each of the profile passes within the selected toolpath is automatically numbered at its Start Point.

In our example, the *Profile* vector text appears as follows:

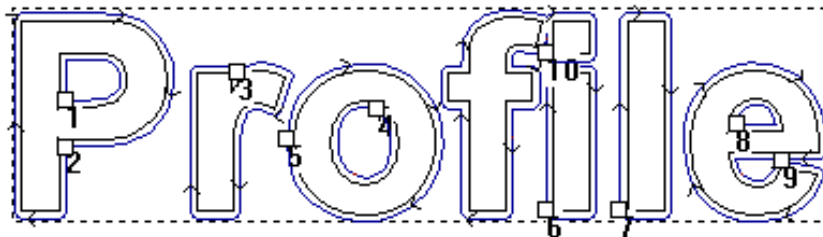

5. Click on each of the profile passes in the toolpath in turn to set the order in which they are machined.

The cursor  shows the number that will be given to the next profile pass that you click on. The position of each profile pass in the overall machining order is also displayed in the **Segment Position** box as you click on it.

In our example, if we click on the profile pass inside of the central cavity of the letter *o* in the *Profile* vector text first,

and then on the profile pass around the outside of the letter, they are numbered as 1 and 2 respectively:

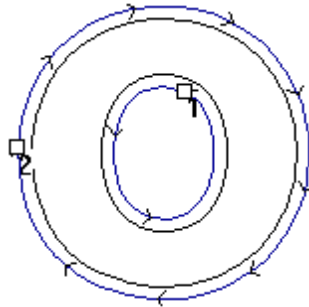

---

**Note:** It is recommended that you machine the profile pass inside of a central cavity before the profile pass around the outside of the selected text.

---

6. Click on the **Close** button to return to the **Toolpaths** Home page.

### ***Resetting the Machining Order***

You can correct any mistakes you make when setting the machining order of the profile passes in a selected toolpath.

To reset the current machining order:

1. Click on the **Reset Count** button.
2. Click on the profile pass that you want to set as the first to be machined.
3. Continue this process until each profile pass in the toolpath is numbered accordingly.

### ***Manipulating the Machining Order***



You can manipulate the order in which the profile passes are machined in a selected toolpath by using the options in the **Segment Ordering** area of the **Toolpath Ordering** page:

- Click on the **Order segments from start** radio button  to machine the numbered profile passes in sequential order. The cursor shows the number that is to be given to the next profile pass that you click on, counting upwards from 1.
- Click on the **Order segments from end** radio button  to machine the numbered profile passes in reverse order. The cursor shows the number that is to be given to the next profile pass that you click on, starting with the number

equal to the total number of profile passes in the toolpath and counting down.

- Click on the **Swap segments** radio button  to swap the position in the machining order of the first profile pass you click on with that of the second you click on.

The cursor shows two question marks . After you click on the profile pass that you want to swap with another, its number is shown on the cursor.

For example, the cursor is shown as  when you click on the first segment. After you click on the profile pass that you want to swap with that which is already selected, the cursor returns to .

## Adjusting the Machining Parameters of a Tool

You can adjust the machining parameters for CNC machine tools in ArtCAM Pro as follows:

- When creating a toolpath, in the toolpath's page. For example, the **Profiling** page. For details, see "Adjusting Machining Parameters When Creating a Toolpath" on page 540.
- After creating a toolpath, using the **Toolpaths** Home page. For details, see "Adjusting Machining Parameters in a Created Toolpath" on page 542.



---

**Note:** You can also change the tool's default machining parameters stored in the **Tool Groups Database**. This method should only be used before selecting a toolpath. For details, see "Editing a Tool" on page 556.

---

### *Adjusting Machining Parameters When Creating a Toolpath*

You can change the machining parameters of the CNC machine tool used to machine a model, when creating a toolpath.

To change the machining parameters of a CNC machine tool:

1. With the toolpath page displayed in the **Assistant** window, display the machining parameters of the selected tool by clicking on the  arrow in the tool area of the page.

For example, if you have selected a 3mm End Mill tool in a Profiling toolpath, the tool area of the **Profiling** page looks like this:

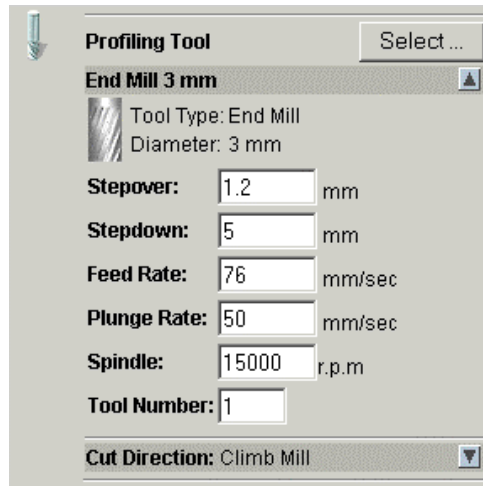

2. You can now set the new machining parameters:
  - To change the stepover of the selected tool, define the new distance between adjacent machining passes in the **Stepover** box.
  - To change the stepdown of the selected tool, define its maximum cutting depth in the **Stepdown** box. The stepdown generates multiple machining passes.
  - To change the feed rate of the selected tool, define the new rate at which the tool moves in relation to the block of material in the **Feed Rate** box.
  - To change the plunge rate of the selected tool, define the rate at which the tool moves in the Z direction and plunges into the block of material in the **Plunge Rate** box.
  - To change the rotational speed of the spindle, define the new speed in the **Spindle** box. The spindle is the part of the machine tool that rotates during operation. On a mill it holds the tool in position. On a lathe it holds the block of material.
  - To give the selected tool a number, click on the **Tool Number** list box and then on the number you want to assign to it. This number should correspond with

the position of the tool in the CNC machine's tool changer.

## Adjusting Machining Parameters in a Created Toolpath

When you have created a toolpath, you can adjust the machining parameters, except for the **Stepdown** and the **Stepover**. In addition, you can amend toolpath parameters such as the **Home Position** and the **Safe Z** level.

To adjust the machining or toolpath parameters:

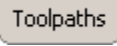
1. Click on the **Toolpaths** tab  to display the **Toolpaths** Home page.
2. Click to select the tool listed beneath the toolpath name for which you want to change the machining parameters. For details, see "Selecting Toolpaths" on page 509.

For example, a 3mm End Mill tool used in creating a Profiling toolpath appears as follows:



3. Click on the **Edit Parameters** button to display the machining parameters for the selected tool.

For example, if you selected a 3mm End Mill tool when creating a Profiling toolpath, the **Parameters** area looks like this:

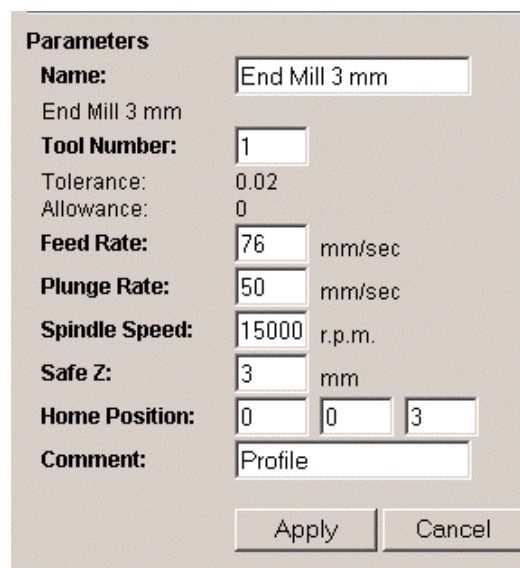



4. You can change the machining parameters in this area as described in "Adjusting Machining Parameters When Creating a Toolpath" on page 540.

In addition, you can amend:

- The tool's name.
- The height, or **Safe Z** level, at which the cutting tool makes rapid moves between toolpath segments.
- The **Home Position** (XYZ) of the tool.
- The comment about the toolpath, usually its name.



5. Click on the **Apply** button.

## Saving a Toolpath

When you have created a toolpath, it can be saved in two formats:

- You can save the toolpaths along with the model you are currently working on as a model file (\*.art). For details, see "Saving a Model" in the Working with Models chapter.
- You can export the toolpath data as a file specific to your CNC machine tool, as explained below.

To save the toolpath data as a machine-specific file:

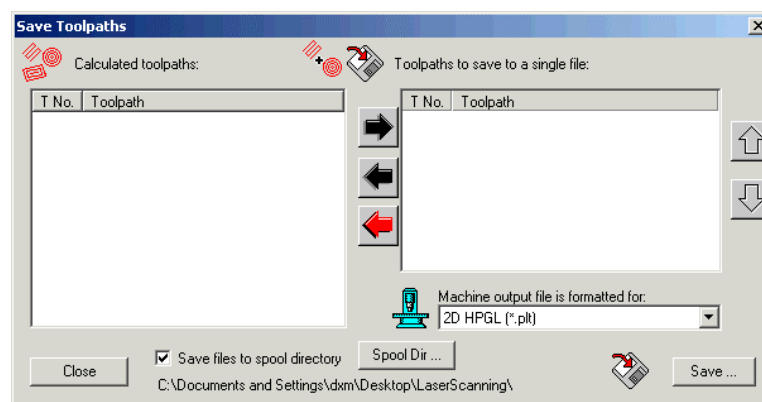

1. Click on the **Toolpaths** tab  to display the **Toolpaths** Home page.
2. Click on the **Save Toolpaths** button  in the **Toolpath Operations** area to open the **Save Toolpaths** dialog box:



3. Click on the toolpaths in the **Calculated toolpaths** window that you want to save as one machine-specific toolpath file.

To select more than one toolpath, hold the **Shift** key down on your keyboard and then click on each of the toolpaths.

4. Click on the right button  to transfer your selected toolpaths to the **Toolpaths to save to a single file** window.
5. Make sure that the toolpaths are in the correct order.

Click on the up  and down  buttons to set the order in which the toolpaths will be saved. Each click, up or down, moves the selected toolpath one position in the list.

Click on the black left button  to transfer the currently highlighted toolpaths back to the **Calculated toolpaths** window.

Click on the red left button  to transfer all toolpaths back to the **Calculated toolpaths** window.

6. Click on the **Machine output file is formatted for** list box, and then click to select the machine format you want to use.
7. If you want to save the machine-specific toolpath file to the spool directory, make sure that the **Save Files to Spool Directory** option is selected .

If you have not already selected the spool directory, click on the **Spool Dir...** button to display the **Browse For Folder** dialog box. Click on the folder to which you want to spool your machine-specific toolpath files, followed by the **OK** button to set it as the spool directory.

If you do not want to save the machine-specific toolpath file to the spool directory, make sure that the **Save Files to Spool Directory** option is deselected .

8. Click on the **Save** button.
9. Type the file name for the machine-specific toolpath in the **File name** box.
10. Click on the **Save as type** list box, then click to select the file type in which you want to save your machine-specific toolpath.
11. Click on the **Save** button to close the **Save As** dialog box.

12. Click on the **Close** button in the **Save Toolpaths** dialog box.



---

**Note:** You can also save a toolpath from either the **2D View** or the **3D View** in the same way. From the Main menu bar, click on the **Toolpaths** menu, followed by the **Save Toolpath** option to display the **Save Toolpaths** dialog box. For details on using the **Save Toolpaths** dialog box, return to the start of this section.

---

## Editing a Toolpath



You can change the settings in any toolpath that you have created.

To edit the settings in a toolpath using the **2D View** window:

1. Click on the **Select Vectors** button  in the **Vector Editing** area of the **Assistant's** Home page. For details, see "Selecting Vectors" in the Working with Vectors chapter.
2. Select the preview of the toolpath that you want to edit. For details, see "Selecting Toolpaths" on page 509.
3. Right-click to display the Toolpath menu, and then click on the **Edit Toolpath** option to display the toolpath's details in the **Assistant** window.

For example, if you select a Profiling toolpath and then the **Edit Toolpath** option from the Toolpath menu, the **Profiling** page is displayed in the **Assistant** window.

Alternatively, you can edit toolpath settings using the **Toolpaths** Home page:

1. Click on the **Select Vectors** button  in the **Vector Editing** area of the **Assistant's** Home page. For details, see "Selecting Vectors" in the Working with Vectors chapter.
2. Click on the **Toolpaths** tab  to display the **Toolpaths** Home page.
3. Select the toolpath listed that you want to edit. For details, see "Selecting Toolpaths" on page 509.

4. Click on the **Edit Toolpath** button  in the **Toolpath Operations** area to display the page for the toolpath in the **Assistant** window.

## Deleting Toolpaths

You can delete a toolpath or toolpath group that you have created.

A toolpath group is a toolpath that requires the use of more than one machining tool. For example, a Bevelled Carving toolpath uses both a Carving tool and a Profiling tool.

### *Deleting a Toolpath*

To delete a toolpath from the **2D View** window:

1. Click on the **Select Vectors** button  in the **Vector Editing** area of the **Assistant's** Home page. For details, see "Selecting Vectors" in the Working with Vectors chapter.
2. Select the preview of the toolpath that you want to delete to select it. For details, see "Selecting Toolpaths" on page 509.

For example, if you want to delete the profile pass in a Bevelled Carving toolpath it would appear something like this when selected:

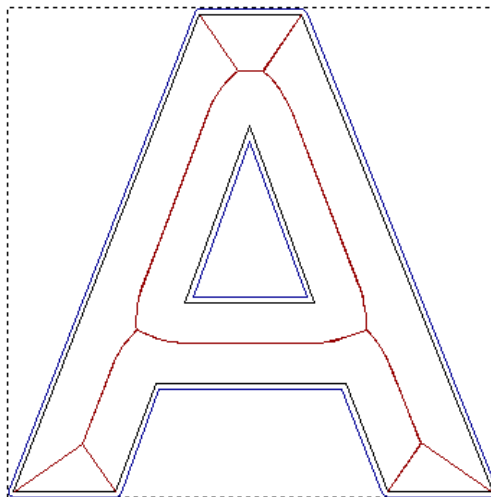

3. Right-click to display the Toolpaths menu, then click on the **Delete Toolpath** option.

In our example, you can see that the profile pass in the Bevelled Carving toolpath is now deleted:

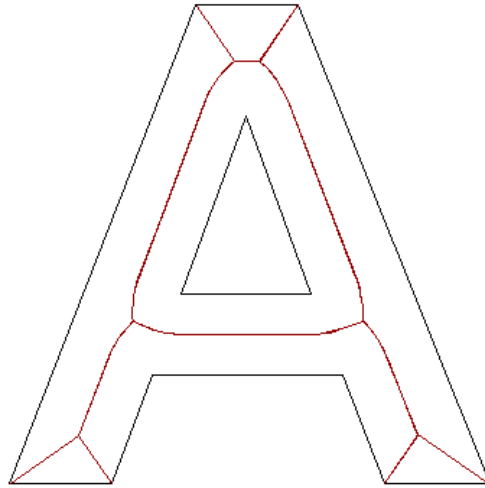

## ***Deleting a Toolpath Group***

To delete a toolpath group using the **2D View** window:

1. Click on the **Select Vectors** button  in the **Vector Editing** area of the **Assistant's** Home page. For details, see "Selecting Vectors" in the Working with Vectors chapter.
2. Select a preview toolpath that is part of a toolpath group to select it. For details, see "Selecting Toolpaths" on page 509.

The selected part of the toolpath group is blue and surrounded by a bounding box.

For example, if you want to delete a Bevelled Carving toolpath, and select the profile pass in the toolpath, the toolpath looks like this when selected:

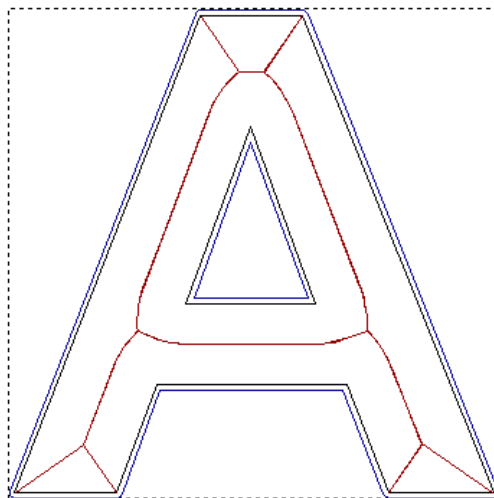

3. Right-click to display the Toolpaths menu, then click on the **Delete Toolpath Group** option.

In our example, you can see that both the centreline and the profile pass in the Bevelled Carving toolpath group are now deleted:

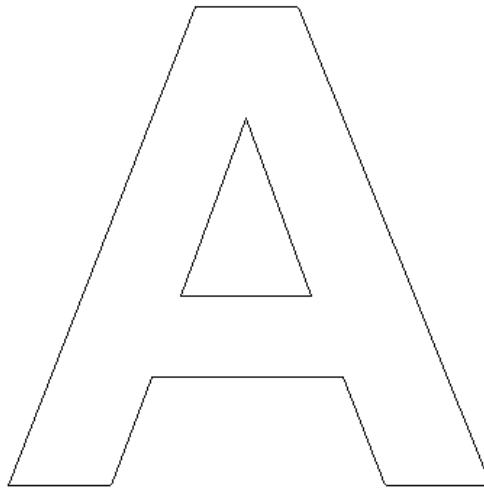

---

**Note:** You can also delete a toolpath using the **Toolpaths** Home page by clicking on the toolpath group listed to select it, for example Bevelled Carving, and then on the **Delete Toolpath** button  in the **Toolpath Operations** area.

---

## Calculating a Single Toolpath

You can calculate a single toolpath during its creation using the **Now** button on the page corresponding to it. For example, when the **Profiling** page is shown in the **Assistant** window.

If you had chosen to calculate a toolpath **Later**, you can calculate it at a later time using the **Toolpaths** Home page. For details, see "2D Toolpaths" on page 405 and "3D Toolpaths" on page 481.

All toolpaths listed on the **Toolpaths** Home page in yellow have not yet been calculated. All toolpaths listed in black have already been calculated.

To calculate a toolpath using the **Toolpaths** Home page:

1. Select the toolpath that you want to calculate. For details, see "Selecting Toolpaths" on page 509.
2. Click on the **Calculate Selected Toolpath** button  in the **Toolpath Operations** area.
3. The page relating to the selected toolpath appears in the **Assistant** window and the calculation process begins. The

page shown in the **Assistant** window is automatically closed when the calculation process is complete.

## Calculating a Batch of Toolpaths

You can calculate a sequence of toolpaths at once using ArtCAM Pro's batch calculation process. This gives you the freedom to work continuously on creating a model during the day, and calculate all of its corresponding toolpaths during the night.

If you had chosen to calculate several toolpaths **Later** during their creation, you can calculate them in a batch sequence using the **Toolpaths** Home page. For details, see "2D Toolpaths" on page 405 and "3D Toolpaths" on page 481.

All toolpaths listed on the **Toolpaths** Home page in yellow have not yet been calculated. All toolpaths listed in black have already been calculated.

To calculate a batch of toolpaths:

1. Click on the **Batch Calculate Toolpaths** button  in the **Toolpath Operations** area of the **Toolpaths** Home page to display the **Batch Calculate Toolpaths** dialog box.

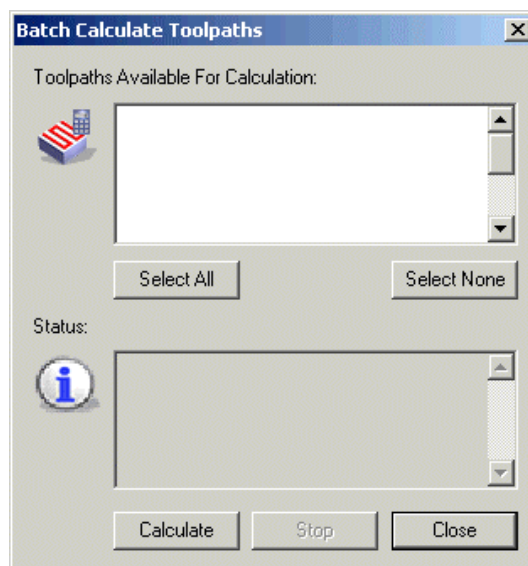

2. From the **Toolpaths Available For Calculation** window, make sure that all of the toolpaths that you want to calculate as part of this batch are selected . All of the available toolpaths are selected  by default.

If you click on a selected toolpath  it is then deselected , and vice versa.

You can deselect all of the available toolpaths by clicking on the **Select None** button.

To select all of the available toolpaths, click on the **Select All** button.

3. Click on the **Calculate** button to begin the batch calculation process.

The following details are displayed in the **Status** window during the batch calculation process:

- The time and date on which the batch calculation process commences.
- The elapsed time for the calculation of each of the toolpaths within the batch.
- The elapsed time for the entire batch calculation process.

If you want to cancel the batch calculation process at any time, click on the **Stop** button.

4. Click on the **Close** button to close the **Batch Calculate Toolpaths** dialog box.

## Using a Toolpath Summary

You can review, print or save details of all of the toolpaths that you have created in order to machine a model.

The **Toolpath Summary Information** dialog box displays the following details:

- Job dimensions used.
- Toolpaths used.
- Machining parameters of all tools used.

A total machining cycle time is also calculated based on the Feed Rates of the various tools that you had selected when creating a toolpath.

To display the **Toolpath Summary Information** dialog box for the model:

1. Click on the **Toolpaths** tab  to display the **Toolpaths** Home page.



2. Click on the **Toolpath Summary** button  in the **Toolpath Operations** area to display the **Toolpath Summary Information** dialog box:

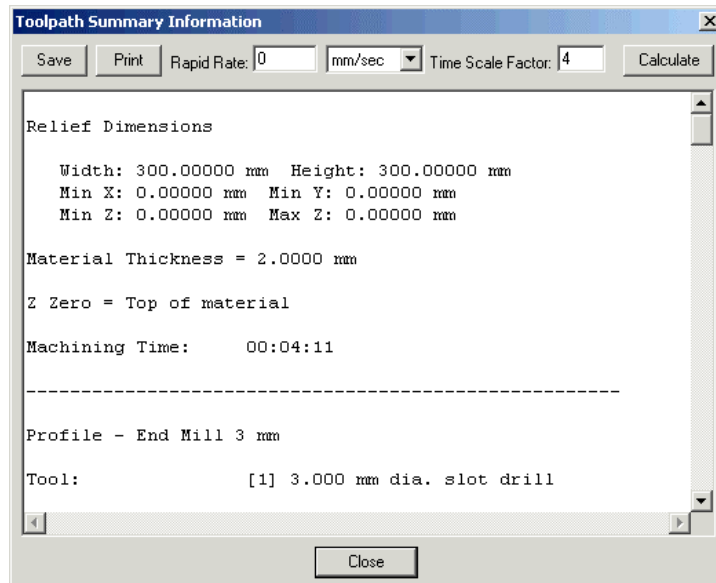



You can use the scrollbar at the right of the **Toolpath Summary Information** dialog box to view all of the toolpath information.

## ***Calculating the Estimated Machining Time***

You can amend the machining parameters to estimate the actual machining time for a job.

To calculate the estimated machining time of a toolpath:

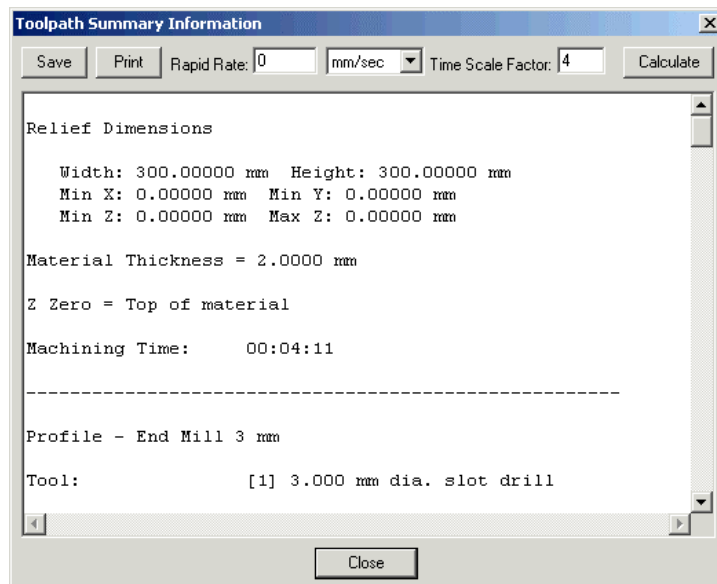

1. Click on the **Toolpaths** tab  to display the **Toolpaths** Home page.
2. Click on the **Toolpath Summary** button  in the **Toolpath Operations** area to display the **Toolpath Summary Information** dialog box:



3. Define the rapid rate of your CNC machine in the **Rapid Rate** box. You should confirm the maximum Rapid Rate of your CNC machine by consulting the manufacturer's manual. If the manual contains no reference to the maximum Rapid Rate, use the maximum Feed Rate value instead.
4. Click on the list box and then click to select the appropriate unit of speed for your CNC machine.
5. Define the time scale factor that you want to apply to the machining process in the **Scale Factor** box. The default time scale factor is 4. You should experiment with finding the appropriate value for your machining.
6. Click on the **Calculate** button.
7. Click on the **Close** button to close the **Toolpath Summary Information** dialog box.

## ***Printing a Toolpath Summary***

To print a toolpath summary:

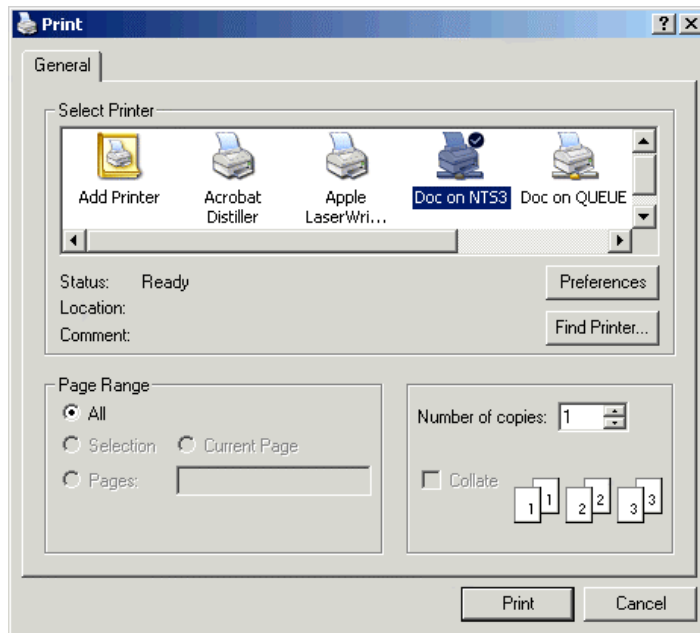

1. Click on the **Toolpaths** tab  to display the **Toolpaths** Home page.
2. Click on the **Toolpath Summary** button  in the **Toolpath Operations** area to display the **Toolpath Summary Information** dialog box.
3. Click on the **Print** button to display the **Print** dialog box:



4. From the **Select Printer** window, click on the icon of the printer that you want to use to print the toolpath summary.
5. Click on the **Print** button to print the toolpath summary at the selected printer.
6. Click on the **Close** button to close the **Toolpath Summary Information** dialog box.

## ***Saving a Toolpath Summary***

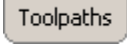
To save a toolpath summary:

1. Click on the **Toolpaths** tab  to display the **Toolpaths** Home page.
2. Click on the **Toolpath Summary** button  in the **Toolpath Operations** area to display the **Toolpath Summary Information** dialog box:

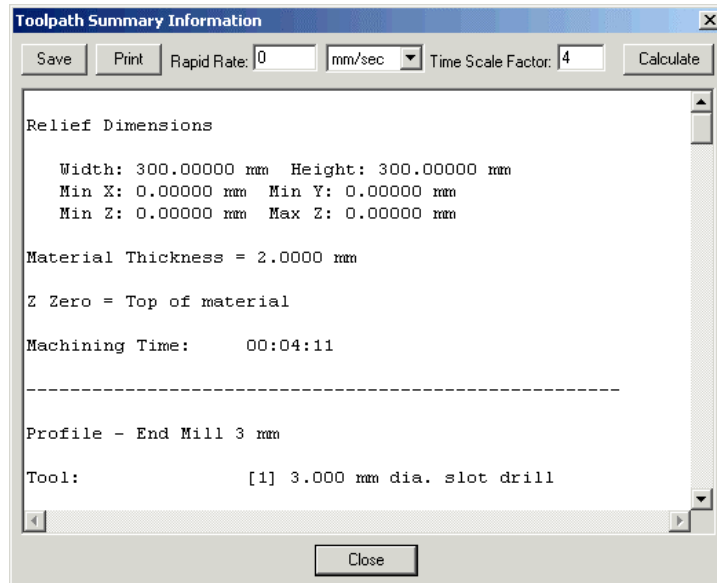

3. Click on the **Save** button to display the **Save Toolpath Summary** dialog box.
4. Click on the **Save In** list box and select the directory where you want to save the toolpath summary.
5. Type the file name you want to use for the toolpath summary in the **File name** box.
6. Click on the **Save** button. The file is saved as a text file (\*.txt).
7. Click on the **Close** button to close the **Toolpath Summary Information** dialog box.

## Using the Tool Groups Database



When creating a toolpath in ArtCAM Pro, it is necessary to select a tool with which to machine your model. A broad range of pre-defined tools can be selected from the **Tool Groups Database**.

The **Tool Groups Database** allows you to:

- Select a tool with which to machine a toolpath. For details, see "2D Toolpaths" on page 405 and "3D Toolpaths" on page 481.
- Define and add your own tools.
- Edit the default machining parameters of any selected tool.
- Group tools together, as you prefer.

## Adding a Tool

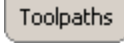
To define and add a new tool to the **Tool Groups Database**:

1. Click on the **Toolpaths** tab  to display the **Toolpaths** Home page.
2. Click on the **Tool Database** button  in the **Toolpath Operations** area to open the **Tool Groups Database**:

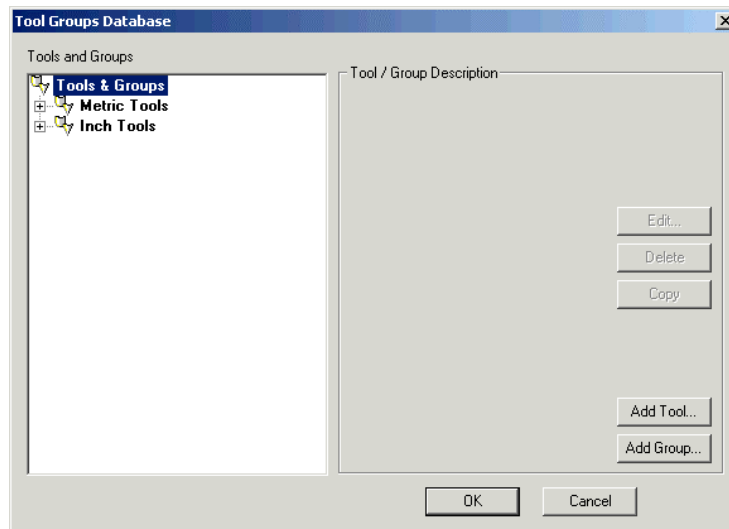

3. Click on the **Add Tool** button to open the **Add Tool** dialog box:

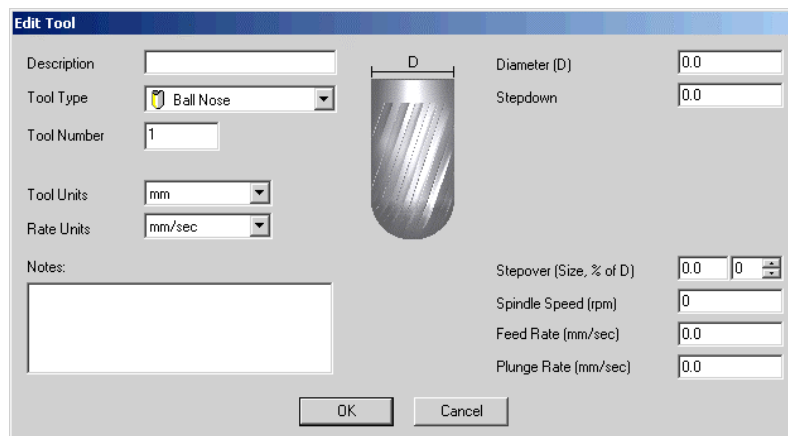

4. Type a name for the tool in the **Description** box.
5. Click on the **Tool Type** list box, and then click to select one of the tool types listed. An image representing the selected **Tool Type** appears in the middle of the dialog box. Boxes to type in the necessary machining parameters of the tool appear in the right side of the dialog box.
6. Set the number of the tool according to its current position on your tool changer in the **Tool Number** box.

7. Click on the **Tool Units** list box, and then click to select the unit of measurement for the tool.
8. Click on the **Rate Units** list box, and then click to select the unit of speed for the tool.
9. Type any relevant information concerning the practical use of the tool you are adding to the **Tool Groups Database** in the **Notes** box.
10. Define the machining parameters of the tool using the boxes on the right of the dialog box. For example, **Diameter**, **Stepover** and **Flute Length**.
11. Click on the **OK** button to add the tool to the **Tool Groups Database**. The tool you have added appears in the **Tools and Groups** window, and its details appear in the **Tool / Group Description** area of the **Tool Groups Database**.
12. Click on the tool in the **Tools and Groups** window and drag it into the appropriate group in the **Tool Groups Database**.



---

**Note:** For details on how to set up your own group, see "Adding a Tool Group" on page 559.

---

13. Click on the **OK** button to close the **Tool Groups Database**.



### ***Editing a Tool***

You can edit the geometry and the default machining parameters of any tool selected from the **Tool Groups Database**:

- **Description** – To change the name of the selected tool, type it in this box.
- **Tool Number** – To change the number of the selected tool to correspond with its position on a tool changer, define it in this box.
- **Tool Units** – To change the unit of measurement for the selected tool, click on the **Tool Units** list box and then on the unit of measurement you want to use.
- **Rate Units** – To change the unit of speed for the selected tool, click on the **Rate Units** list box and then on the unit of speed you want to use.

- **Notes** – If you want to make any notes about the selected tool, type them in this box.
- **Diameter** – To change the diameter of the selected tool, define it in this box.
- **Stepdown** – If you want to change the maximum cut depth of the selected tool, define it in this box.
- **Stepover** – If you want to change the distance between adjacent machining passes made by the selected tool, define it in this box.



You can also adjust the stepover of the selected tool using the **% of** box and buttons:

- Each click on  increases the stepover of the selected tool by 1% of the value shown in the **Diameter** box.
- Each click on  decreases the stepover of the selected tool by 1% of the value shown in the **Diameter** box.
- Type a value in the **% of** box to define the **Stepover** as a percentage of the tool **Diameter**.
- **Spindle Speed** – To change the rotational speed of the spindle, define it in this box.
- **Feed Rate** – To change the rate at which the tool moves in relation to the block of material, define it in this box.
- **Plunge Rate** – To change the rate at which the tool moves in the Z direction and plunges into the block of material, define it in this box.

Editing the geometry of certain types of tools in the **Tool Groups Database** requires more data than with other tools. The additional information required includes:

- **Included Angle** – To change the angle of a V-Bit tool, define the new angle in this box.
- **Half Angle** – To change the angle of a Conical tool, define the new angle in this box.
- **Flat Radius** – To change the radius of a flat Conical tool, define the new radius in this box.
- **Tip Radius** – To change the radius of a rounded Conical tool, define the new radius in this box.

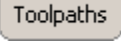
To edit the machining parameters or the geometry settings of a tool in the **Tool Groups Database**:

1. Click on the **Toolpaths** tab  to display the **Toolpaths** Home page.
2. Click on the **Tool Database** button  in the **Toolpath Operations** area to open the **Tool Groups Database**:

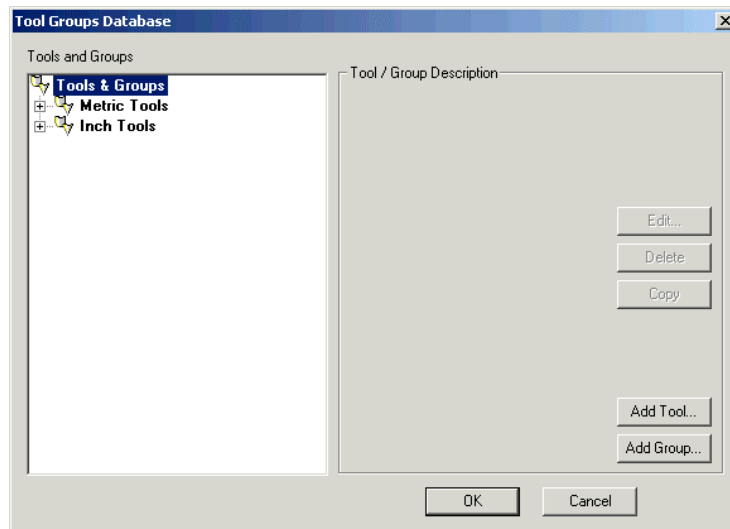

3. Click on the tool in the **Tools and Groups** window that you want to edit. The selected tool is highlighted in blue.





---

**Note:** Before editing the machining parameters of a selected tool, you may want to make a copy of it. To do so, click on the tool in the **Tools and Groups** window, and then click on the **Copy** button. A copy of the tool appears directly beneath the original in the **Tools and Groups** window.

---

The machining parameters of the selected tool appear in the **Tool / Group Description** area of the dialog box.

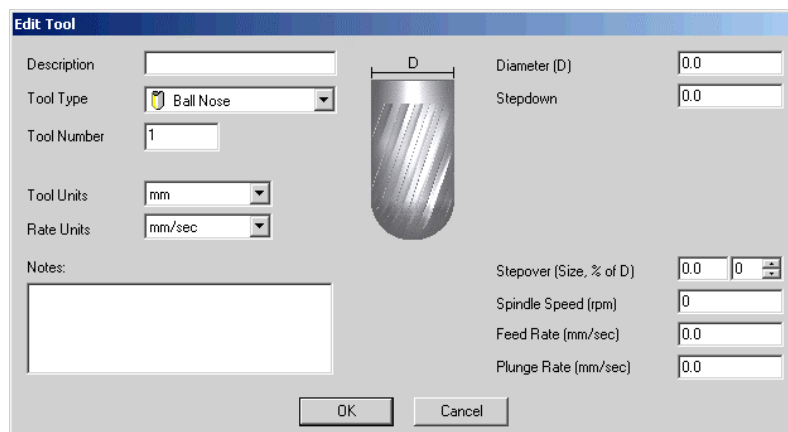
4. Click on the **Edit** button to open the **Edit Tool** dialog box:





5. Define all new machining parameters and tool geometry settings for the selected tool using the boxes in the dialog box, or by clicking on the appropriate options in the list boxes.
6. Click on the **OK** button to save these new settings and parameters and to return to the **Tool Groups Database**.

The tool you have edited appears in the **Tools and Groups** window, and the information that you had typed in the **Edit Tool** dialog box appears in the **Tool / Group Description** area of the **Tool Groups Database**.

7. Click on the **OK** button to close the **Tool Groups Database**.

## ***Copying a Tool***

You can copy any tool within the **Tool Groups Database**:

1. Click on the tool that you want to copy in the **Tools and Groups** window. The selected tool is highlighted in blue.
2. Click on the **Copy** button. A copy of the tool appears directly beneath the original tool. You can move the location of the tool by clicking and dragging on it.

## ***Deleting a Tool***

You can delete any tool listed in the **Tool Groups Database**:

1. Click on the tool that you want to delete in the **Tools and Groups** window. The selected tool is highlighted in blue.
2. Click on the **Delete** button. A message box appears requesting you to confirm your decision to delete the tool.
3. Click on the **Yes** button to delete the tool.

## ***Adding a Tool Group***

Within the **Tool Groups Database**, tools are organised into various groups for ease of reference. When you define and add a selection of tools to the **Tool Groups Database**, you may want to create a new group for them.

To create a new tool group:

1. Click on the **Tool Database** button  in the **Toolpaths** area of the **Assistant's** Home page to open the **Tool Groups Database**:

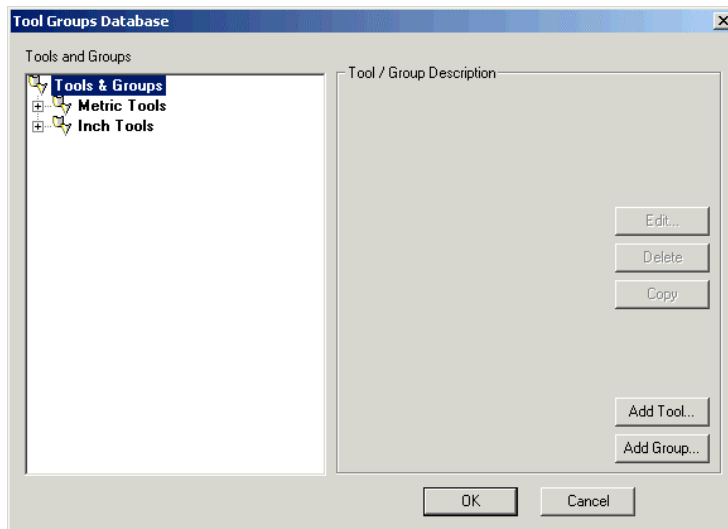



2. Click on the **Add Group** button. A folder named **New Group** appears in the **Tools and Groups** window:



3. Click on the **New Group** folder, and type the name for the tool group you want to add to the database. You can now click and drag any tools listed in the **Tools and Groups** window into the tool group folder that you have created.
4. Click on the **OK** button to close the **Tool Groups Database**.

## ***Editing a Tool Group***

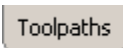
You can edit the name and description of any tool group selected from the **Tool Groups Database**:

1. Click on the **Toolpaths** tab  to display the **Toolpaths** Home page.
2. Click on the **Tool Database** button  in the **Toolpath Operations** area to open the **Tool Groups Database**:

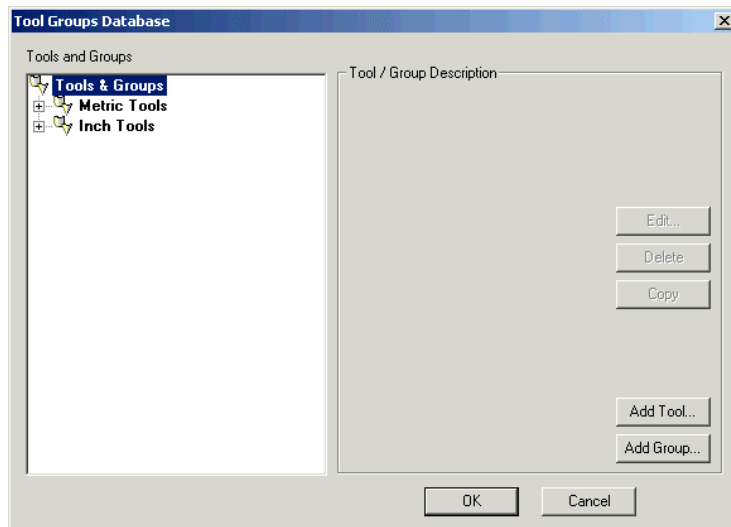

3. Click on the tool group in the **Tools and Groups** window that you want to edit. The selected tool group is highlighted in blue and details about the group appear in the **Tool / Group Description** area of the database.
4. Click on the **Edit** button to open the **Edit Group** dialog box:

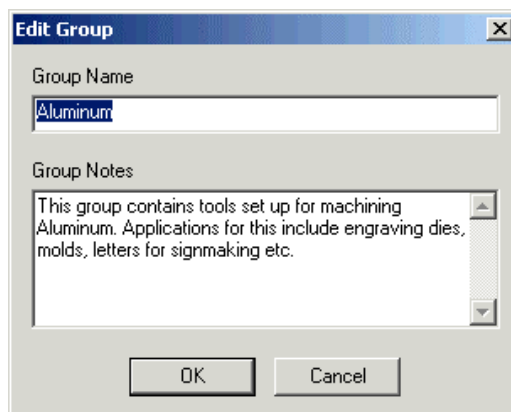

5. If you want to give the tool group a new name, type it in the **Group Name** box.
6. If you want to make any notes about the selected tool group, type them in the **Notes** box.
7. Click on the **OK** button to close the **Edit Group** dialog box.

## ***Copying a Tool Group***

You can copy any tool group within the **Tool Groups Database**:

1. Click on the tool group that you want to copy in the **Tools and Groups** window. The selected tool group is highlighted in blue.

2. Click on the **Copy** button. A copy of the tool group appears directly beneath the original tool group. You can move the location of the tool group by clicking and dragging on it.

## ***Deleting a Tool Group***

You can delete any tool group listed in the **Tool Groups Database**:

1. Click on the tool group that you want to delete in the **Tools and Groups** window. The selected tool group is highlighted in blue.
2. Click on the **Delete** button. A message box appears requesting you to confirm your decision to delete the tool group.
3. Click on the **Yes** button to delete the tool group.

## ***Saving the Tool Groups Database***

If you make any changes to the **Tool Groups Database**, and then click on the **OK** button to close the database, the following message box appears:

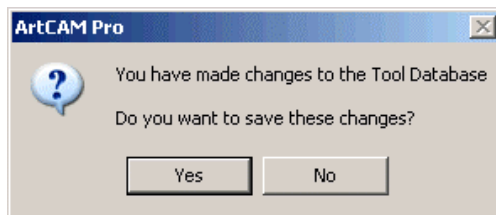



Click on the **Yes** button to save the changes that you have made to the database before closing it, or click on the **No** button to close the database without saving your changes.

## ***Adjusting the Material Setup***

You can edit the thickness of a block of material and the position of a model within it. You can also change the origin in the block of material.

To adjust the material setup:

1. Click on the **Toolpaths** tab  to display the **Toolpaths** Home page.
2. Click on the **Material Setup** button  in the **Toolpath Operations** area to display the **Material Setup** dialog box:

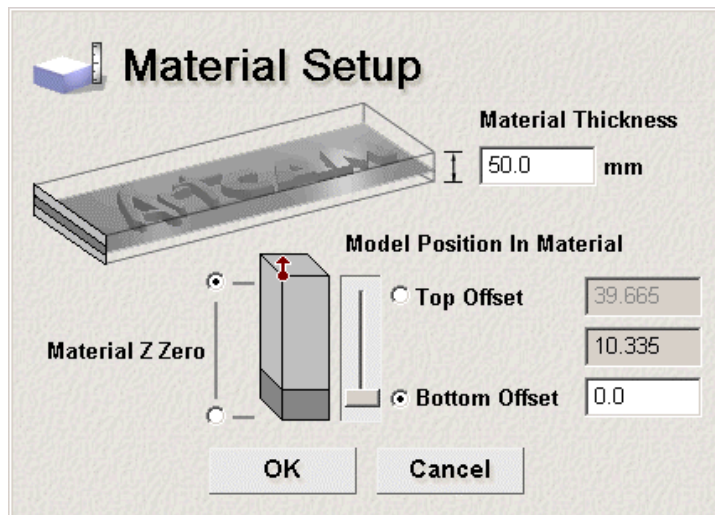

3. Type a value in the **Material Thickness** box to define the depth (Z) of the block of material.
4. To set the Z zero position in the block of material, click on either of the radio buttons  in the **Material Z Zero** area.  
The **Material Z Zero** icon  appears on the top or the bottom of the block to mark the origin.
5. To specify the amount of material above the relief surface, click on the **Top Offset** radio button  in the **Model Position In Material** area, and then either:
  - Type a value in the **Top Offset** box.
  - Click and drag on the slider to adjust the value in the **Top Offset** box.

The value in the **Bottom Offset** box changes automatically as the value in the **Top Offset** box changes.





---

**Note:** The second box in the **Model Position In Material** area shows the current depth (Z) of the existing relief.

---

6. To specify the amount of material below the base of the relief, click on the **Bottom Offset** radio button  in the **Model Position In Material** area then either:
7. Click on the **OK** button to close the **Material Setup** dialog box and save the settings.

You can also adjust the material set-up using the **Project** page:

1. Click on the **Project** tab  to display the **Project** page.

2. With the **Machining** element shown, click on the material thickness value to display the **Material Setup** dialog box.

For information on how to use the **Material Setup** dialog box, return to the beginning of this section. For further details, see "Viewing Model Information" in the Working with Models chapter.



## Deleting the Material

You can delete the material that you have defined using the **Material Setup** dialog box.

If you have changed the position and/or origin of a model using the **Material Setup** dialog box, neither the model nor its origin revert to their previous positions after the material has been deleted. You can reset the position of the model after the material has been deleted using either the **Set Position** dialog box or the **Material Setup** dialog box.

For details, see "Setting the Position of a Model" in the Working with Models chapter and "Adjusting the Material Setup" on page 562.

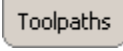
To delete the material:

1. Click on the **Toolpaths** tab  to display the **Toolpaths** Home page.
2. Click on the **Delete Material** button  in the **Toolpath Operations** area.



The material is deleted from the **3D View** window and is no longer listed in the **Objects To Draw** list box. For details, see "Objects To Draw" in the ArtCAM Pro Layout chapter.

## Creating a Toolpath Template

You can create a template from any toolpath(s) that you have either created or calculated in ArtCAM Pro. The toolpath template file contains all of the original settings that you have made when creating the toolpath(s). The toolpath settings saved within the template can then be applied to vector artwork drawn within an ArtCAM model file.

The toolpath template file (\*.tpl) contains all of the original settings that you had made when creating the toolpath. The settings saved within the toolpath template can then be applied to a selected vector object in order to machine all or part of a model.

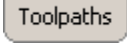
To create a toolpath template:

1. Click on the **Toolpaths** tab  to display the **Toolpaths** Home page.
2. Make sure that only the toolpaths that you want to save as a template are listed on the page. These toolpaths can either be created or calculated. Created toolpaths are listed in red text, whilst calculated toolpaths are listed in black text.
3. Click on the **Save Toolpath As Template** button  in the **Toolpath Operations** area to display the **Save Toolpath Template** dialog box.
4. Click on the **Save In** list box and select the directory you want to save the toolpath template in.
5. Type the file name you want to use for the toolpath template in the **File** name box.
6. Click on the **Save** button.



The toolpath template can now be loaded at any time to machine all or part of a model. For details, see "Loading a Toolpath Template" on page 565.

## Loading a Toolpath Template

When you load a toolpath template, the toolpath settings within the file are automatically assigned to the vector object in the model from which the original toolpath that forms the template was created.

If the vector object from which the original toolpath was created has been deleted, or you want to use the template with a different model altogether, you need to select the vector object to which you want to assign the toolpath template before the toolpath can be edited or calculated.

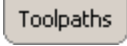
To load a toolpath template file (\*.tpl):

1. Click on the **Toolpaths** tab  to display the **Toolpaths** Home page.
2. Click on the **Load Toolpath Template** button  in the **Toolpath Operations** area to display the **Load Toolpath Template** dialog box:

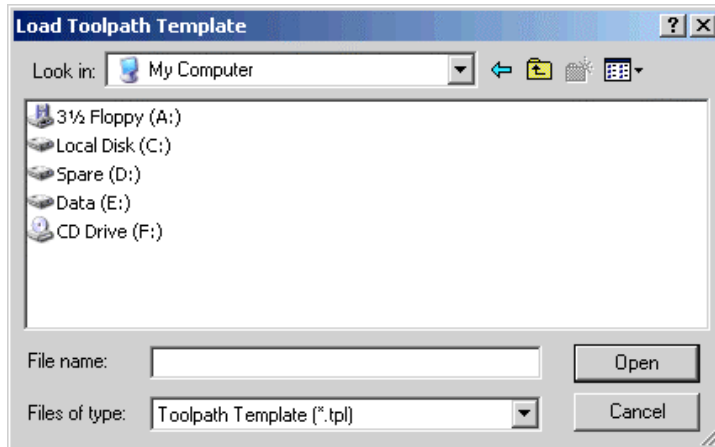

---

**Note:** You can also display the **Load Toolpath Template** dialog box by clicking on the **Toolpaths** menu in the Main menu bar, followed by the **Load Toolpath Template...** option.

---

3. Click on the **Look In** list box, and then click to select the directory in which the toolpath template file you want to use is contained.
4. Once you have found the toolpath template file, click on the file name listed in the main window of the **Load Toolpath Template** dialog box.



---

**Note:** You are only able to select toolpath template files (\*.tpl). You can confirm this by clicking on the **Files of Type** list box.

---

5. Click on the **Open** button to list the toolpath on the **Toolpaths** Home page.

You can now edit or calculate the toolpath that has been loaded. For more details, see "Calculating a Single Toolpath" on page 548, "Calculating a Batch of Toolpaths" on page 549 and "Editing a Toolpath" on page 545.

## Loading Toolpath Data

You can load toolpath data saved as part of an existing ArtCAM model file to another. This allows you to machine several different models at once, depending on the size of your router-bed and if you have access to a tool changer.

To load toolpath data:

1. From the Main menu bar, click on the **Toolpaths** menu, followed by the **Toolpath Data > Load...** option to display the **Open** dialog box:



2. Click on the **Look In** list box, and then click to select the directory in which the ArtCAM model file containing the toolpaths that you want to use is saved.
3. Once you have found the ArtCAM model file, click on the file name listed in the main window of the **Open** dialog box.



---

**Note:** You are only able to select ArtCAM model files (\*.art). You can confirm this by clicking on the **Files of Type** list box.

---

The name of the ArtCAM model you have selected appears in the **File Name** box.



4. Click on the **Open** button to list all of the toolpaths saved as part of the selected ArtCAM model file on the **Toolpaths** Home page.

You can now edit the toolpaths as required. For more details, see "Editing a Toolpath" on page 545.

## Setting the Toolpath Order

Each time a new toolpath is created or calculated it is listed on the **Toolpaths** Home page. The previous toolpath is then moved down a position in this list of toolpaths. This can often mean that the final list of toolpaths does not reflect the order in which you want to machine a job. In this instance, you can reset the order in which created and calculated toolpaths are listed to reflect how you want to machine the job.

To set the order in which created and calculated toolpaths are listed:

1. Click to select the name of the toolpath that you want to prioritise. Its name is highlighted in blue.
2. Use the buttons on the page to set the position of the toolpath in the list:
  - Click on the  button to move the toolpath upwards.
  - Click on the  button to move the toolpath downwards.

---

## Simulating Toolpaths

You can simulate a toolpath that has been calculated. This allows you to visualise the machining passes used to create a finished model. The

name of a calculated toolpath is shown on the **Toolpaths** Home page in black. If it is shown in red, the toolpath has not yet been calculated and cannot be simulated.

A toolpath simulation is a more informative display of the toolpath than that offered by the dark red wireframe drawing that makes up a toolpath preview in the **2D View** window.

You can simulate a calculated toolpath in either the **2D View** or **3D View** window. You can simulate a toolpath in the **2D View** providing that a **2D Preview** has been created when calculating the toolpath.

ArtCAM Pro allows you to simulate calculated toolpaths in the **2D View** window as solid colours. This toolpath simulation method is a more informative display of the toolpath than that offered by the wireframe method of drawing a toolpath preview.



To simulate calculated toolpaths in the **2D View** window as a solid colour:

1. Click to select the calculated toolpath listed on the **Toolpaths** Home page that you want to simulate.
2. Click to select the **Draw Solid** option  beneath the list of calculated toolpaths. If you only want to view a solid colour simulation, make sure that the **Draw Wireframe** option is deselected  also.

Using the **Draw Solid** option allows you to clearly see the areas of the vector artwork that the selected tool will machine, and how effectively the toolpath reproduces the integrity of the original design.

In the example below, the solid colour simulation on the left confirms that we would need to use a tighter tolerance in our toolpath in order to preserve the profile of the letter. The image on the right shows the solid colour simulation of the same toolpath after its tolerance has been adjusted.

Letter 'a' using a loose tolerance...



Letter 'a' using a tighter tolerance...



3. If you want to change the colour of the solid toolpath simulation, click on the colour spot beside the name of the tool used in the toolpath listed on the page to display the **Color** dialog box:

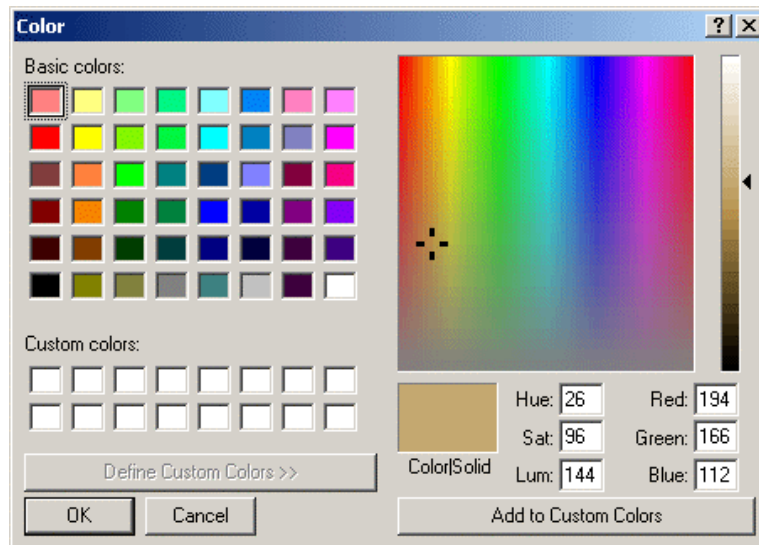

For details on using this dialog box, see "Assigning a Color To A Layer" in the Working with Models chapter.

The default colour assigned to each and every tool used within a toolpath is brown. However, if you assign a new colour to a tool at any stage, this colour will be maintained in all subsequent toolpaths listed on the **Toolpaths** Home page in which the same tool is used. For example, if blue is assigned to a *3 mm End Mill* tool, then the solid simulation for all subsequent toolpaths using a *3 mm End Mill* tool will

also be blue. This does not apply retrospectively, so previous toolpaths using the same tool will not adopt the newly assigned colour.

4. If you want to hide the solid toolpath simulation at any time, you can either:
  - Click to deselect the **Show In 2D** option beside the name of the calculated toolpath .
  - Click to deselect the **Draw Solid** option .

You can simulate calculated toolpaths in the **3D View** window in four different ways:

- A single toolpath.
- An area of a toolpath.
- A group of toolpaths. A toolpath group requires the use of more than one machining tool. For example, Bevelled Carving.
- All toolpaths.

To simulate a toolpath:

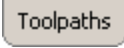
1. Click on the **Toolpaths** tab  to display the **Toolpaths** Home page.
2. Select the toolpath listed on the **Toolpaths** Home page that you want to simulate. For details, see "Selecting Toolpaths" on page 509.



---

**Warning:** You can only simulate calculated toolpaths. These are listed on the **Toolpaths** Home page in black. Uncalculated toolpaths are listed in red.

---







3. Make sure that the machining parameters of the tool listed in the **Parameters** area are correct. If you want to adjust its parameters:
4. Make sure that the **Draw** option in the **Toolpath Simulation** area is selected .
5. You can now simulate the toolpath in either of the following ways:
  - Click on the **Simulate Toolpath Fast** button  to display the **3D View** window and simulate the

whole toolpath using the full capacity of your computer processor.

- Click on the **Simulate Toolpath** button  to display the **3D View** window and the **Simulation Control** panel:



If you click on the **Simulate Toolpath** button , use the playback buttons on the **Simulation Control** panel to simulate the toolpath:

-  – Click on the **Pause Simulation** button if you want to pause the toolpath simulation.
-  – Each click on the **Single Step Simulation** button simulates a successive tool move in the toolpath.
-  – Click on the **Run Simulation at Normal Speed** button if you want to simulate the whole toolpath using only a percentage of your computer processor's capacity.
-  – Each click on the **Run to Next Retract Move** button simulates the toolpath, pausing when the tool retracts from the material, using only a percentage of your computer processor's capacity.
-  – Click on the **Run Simulation at Maximum Speed** button if you want to simulate the whole toolpath using the full capacity of your computer processor.
-  – Each click on the **Run at Maximum Speed to Next Retract** button simulates the toolpath, pausing when the tool retracts from the material, using the full capacity of your computer processor.
-  – Click on the **Abort Simulation** button if you want to stop the toolpath simulation and close the **Simulation Control** panel.



---

**Tip:** You can also simulate a toolpath by clicking on a toolpath preview in the **2D View** window, and then on the **Simulate Toolpath** option from the menu displayed when you right-click.

---







---

**Note:** You can also simulate a toolpath by clicking on a toolpath preview in the **2D View** window, and then clicking on the **Toolpaths** menu in the Main menu bar, followed by the **Simulate Toolpath** option.

---

To simulate an area of a toolpath at the resolution used for the whole relief:

1. In the **2D View**, create a vector object, or move an existing vector object, so that it surrounds the area of the toolpath preview that you want to simulate. For details, see "Drawing with Polylines", "Creating Simple Shapes" and "Moving Vectors" in the Working with Vectors chapter.
2. Make sure the vector object you want to use to define the area of the toolpath that you are simulating is selected. For details, see "Selecting Vectors" in the Working with Vectors chapter.
3. Click on the **Toolpaths** tab  to display the **Toolpaths** Home page.
4. In the **Toolpath Simulation** area, click to select the **Inside Vector** option .
5. Click on either of the simulation buttons to simulate the area of the toolpath defined by the selected vector object:
  - Click on the **Simulate Toolpath** button  to display the **3D View** window and the **Simulation Control** control panel. You can use the playback buttons on the **Simulation Control** panel to control how the toolpath area is simulated.
  - Click on the **Simulate Toolpath Fast** button  to display the **3D View** window and simulate the toolpath area using the full capacity of your computer processor.

To simulate a group of toolpaths:

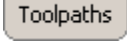
1. Click on the **Toolpaths** tab  to display the **Toolpaths** Home page.



---

**Warning:** You can only simulate calculated toolpaths. These are listed on the **Toolpaths** Home page in black. Uncalculated toolpaths are listed in red.

---

2. Select any part of the calculated toolpath group that you want to simulate. For details, see "Selecting Toolpaths" on page 509.
3. From the Main menu bar, click on the **Toolpaths** menu, followed by the **Simulate Toolpath** option to display a representation of the calculated toolpath group and the machined vector object(s) in the **3D View** window.





---

**Tip:** You can also simulate a toolpath group by selecting a toolpath preview in the **2D View** window that belongs to the group, right-clicking on the toolpath preview to display the Toolpath Editing menu and then clicking on the **Simulate Toolpath Group** option.

---

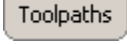
To simulate all of the toolpaths you have calculated:

1. Click on the **Toolpaths** tab  to display the **Toolpaths** Home page.
2. Click on the **Simulate All Toolpaths** button  to display a representation of the calculated toolpaths and the machined vector object(s) in the **3D View** window.



---

**Tip:** You can also simulate all toolpaths group by clicking on the **Toolpaths** menu in the Main menu bar, and then on the **Simulate All Toolpaths** option.

---

## Viewing a Toolpath

You can view a toolpath you have created in both the **2D View** and **3D View** windows. A toolpath is displayed as a sequence of dark red lines in the **2D View** window, and a series of multi-coloured lines in the **3D View** window.

The colour in which a toolpath is displayed within the **3D View** window shows the movement the selected tool will make when machining the vector object.

The following example shows a toolpath simulation as seen along the Y-axis:

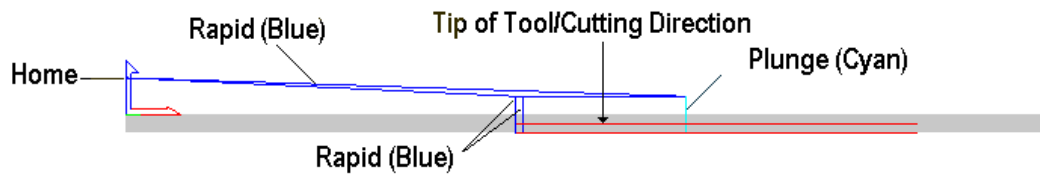

## ***Rapid and Plunge Moves***

The selected tool leaves the **Home** position, moves to the **Safe Z** level, then above and across the material surface until it reaches the point of entry. This movement is known as a **Rapid** move, and a blue line marks this.

The tool cuts into the material surface at its **Plunge** rate. A cyan line marks plunge moves.

Once the cutting is complete, the tool retracts from the block of material to the **Safe Z** level and then moves above and across the material surface until it reaches the **Home** position. This is another **Rapid** move marked by a blue line.

If a toolpath simulation contains several **Rapid** and **Plunge** moves, the lines representing the movement of the selected tool in the **3D View** window can become obscured. For this reason, you may want to hide them from view.

**Rapid** and **Plunge** moves are drawn in a toolpath simulation by default, but can be hidden in either of the following ways:

- Click on the **Toolpaths** menu in the Main menu bar, followed by the **Toolpath Drawing > Draw Rapid and Plunge Moves** option.
- Click to deselect the **Rapid & Plunge Moves** option in the **Machining** area of the **ArtCAM Options** page. For details, see "Managing ArtCAM Pro's Preferences" in the ArtCAM Pro Layout chapter.

## ***Cutting Direction***

As an aid to visualisation, arrows indicating the cutting direction used in a 2D toolpath are used in toolpath previews drawn in the **2D View** window. The cutting direction is hidden by default, but can be shown in either of the following ways:



- Click on the **Toolpaths** menu in the Main menu bar, followed by the **Toolpath Drawing > Show Cutting Direction** option.
- Click to select the **Cutting Direction** option in the **Machining** area of the **ArtCAM Options** page. For details, see "Managing ArtCAM Pro's Preferences" in the ArtCAM Pro Layout chapter.

A Conventional cut direction is illustrated with anti-clockwise arrows, and a Climb Mill cut direction with clockwise arrows. For example, we can see that a Climb Mill cut direction has been used in the Area Clearance toolpath preview shown below:

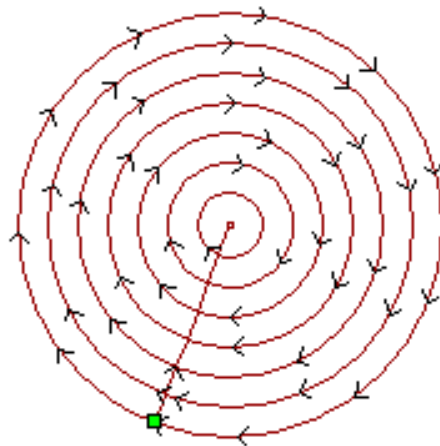

## Hiding a Toolpath

You can hide any toolpath shown in either the **2D View** or **3D View** window.

To hide a toolpath shown in the **2D View** window:

1. Click to select the toolpath preview that you want to hide. For details, see "Selecting Toolpaths" on page 509.
2. Right-click to display the Toolpath Editing menu, and then click on the **Hide Preview** option.

To hide a toolpath shown in the **3D View** window:

1. Double right-click in the **3D View** window to display a list of toolpath viewing options, and then click on the toolpath you want to hide. The toolpath that you want to hide is deselected.

For example, clicking on the **Profile – End Mill 3mm** option hides the toolpath from view.



---

**Note:** You can hide any of the toolpaths shown in the **3D View** window using the **Objects To Draw** button  in the **3D View** toolbar. For details, see "Objects To Draw" in the ArtCAM Pro Layout chapter.



---

## Restoring a Hidden Toolpath

You can restore a toolpath that has been hidden in either the **2D View** or **3D View** window.

To restore a toolpath hidden in the **2D View** window:

1. Click on the **Toolpaths** tab  to display the **Toolpaths** Home page.
2. Make sure that the **2D View** window is displayed

If the **3D View** button  is in the toolbar above the design window, the **2D View** is displayed. If not, click on the **2D View** button .

3. Click to select the **Show In 2D** box next to the relevant toolpath you want to view . The toolpath appears in the **2D View** window in dark red.

To restore a toolpath hidden in the **3D View** window:

1. Double right-click in the **3D View** window to display a list of toolpath viewing options, and then click on the toolpath you want to view. The toolpath that you want to restore is now selected.

For example, clicking on the **Profile – End Mill 3mm** option restores the toolpath to view.



---



**Note:** You can restore any of the toolpaths hidden in the **3D View** window using the **Objects To Draw** button  in the **3D View** toolbar. For details, see "Objects To Draw" in the ArtCAM Pro Layout chapter.

---

## Resetting a Simulation

You can reset a toolpath simulation that has been drawn in the **3D View** window.

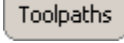
To reset a toolpath simulation:

1. Click on the **Toolpaths** tab  to display the **Toolpaths** Home page.
2. Click on the **Reset Simulation** button  in the **Toolpath Simulation** area.



---



**Note:** You can also reset a toolpath simulation from the Main menu bar by clicking on the **Toolpaths** menu followed by the **Reset Simulation** option.

---

## Deleting a Simulation

You can delete a toolpath simulation from the **3D View** window.

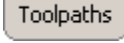
To delete a toolpath simulation:

1. Click on the **Toolpaths** tab  to display the **Toolpaths** Home page.
2. Click on the **Delete Simulation** button  in the **Toolpath Simulation** area.



---



**Note:** You can also delete a toolpath simulation from the Main menu bar by clicking on the **Toolpaths** menu followed by the **Delete Simulation** option.

---

## Saving a Simulation as a Relief

You can save a toolpath simulation as a relief file (\*.rif).



To save a toolpath simulation as a relief:

1. Click on the **Toolpaths** tab  to display the **Toolpaths** Home page.
2. Click on the **Save Simulation As A Relief** button  in the **Toolpath Simulation** area to display the **Save As** dialog box:
3. Click on the **Save In** list box and select the directory in which you want to save the relief.
4. Type the file name that you want to use for the relief in the **File Name** box.
5. Click on the **Save** button.

## Loading a Simulation from a Relief

You can load a toolpath simulation from a relief.

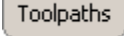
To load a toolpath simulation from a relief:

1. Click on the **Toolpaths** tab  to display the **Toolpaths** Home page.
2. Click on the **Load Simulation From Relief** button  in the **Toolpath Simulation** area to display the **Open** dialog box:
3. Click on the **Look In** list box and find the relief file (\*.rlf) that you want to open.
4. Once you have found the file, click on the file name listed in the main window of the **Open** dialog box. The name of the relief file you have selected appears in the **File Name** box.



---

**Note:** You are only able to select relief files (\*.rlf). You can confirm this by clicking on the **Files of Type** list box.

---

5. Click on the **Open** button to load the relief.

# Index

## 2

- 2D Area Clearance 417
- 2D Toolpaths
  - profiling 407
- 2D View
  - bitmap contrast 18
  - deleting 13
  - grayscale view 17
  - guidelines 23
  - labelling 13
  - link all colours 17
  - linking primary and secondary colours 17
  - merge colours 18
  - opening a new 12
  - printing 106
  - redo 17
  - rulers 20
  - scrolling 19
  - showing and hiding bitmaps 16
  - showing and hiding vectors 16
  - snap grid 21
  - undo 17
  - unlink all colours 17
  - window fit 16
  - zoom aspect ratio 16
  - zoom objects 16
  - zoom out tool 16
  - zoom previous 16

## 3

- 3D Cut Out 498
- 3D Laser Machining 495
- 3D Rest Machining 505
- 3D Shapes
  - blended shapes 374
  - creating a dome 323
  - creating a two rail sweep 310
  - creating a weave 316
  - creating an iso-form letter 320
  - creating from a bitmap 286
  - creating from a vector 290
  - editing attributes applied to bitmap 289
  - editing attributes applied to vector 293
  - extruding 295
  - shape editor 286, 290
  - spinning 301
  - turning 307
- 3D Toolpaths
  - 3D cut out 498
  - 3D laser machining 495
  - 3D rest machining 505
- 3D View
  - draw x y 30
  - draw zero plane 30
  - isometric view 29
  - objects to draw 30
  - pan view 28
  - previous view 29
  - printing 106
  - saving as an image 56
  - scale to fit 29
  - select relief detail 29
  - software shading 31
  - twiddle tool 27
  - view along x 29
  - view along y 29
  - view along z 29
  - zoom 28
  - zoom in tool 15

zoom out 28

## A

### Add

- border around vectors 225
- borders to a model 69
- bridges 528
- colours to the colour palette 137
- lead moves to a profile pass 535
- point to a vector 179
- ramping moves 404
- relief 326
- tool group to database 559

### Adding

- draft angle 368

### Align

- vector text to curve 241
- vectors 257

### Angled Plane 371

### Arc

- converting to a bezier curve 177
- converting to a line 176
- creating 169
- fitting to vectors 211
- inserting a point 179
- inserting a start point 180
- removing 181

### ArtCAM Pro

- assistant 7
- compatible bitmap data 4
- compatible vector data 3
- notepad 80
- options 37
- preferences 37
- screen layout 7
- top toolbar 33
- updating 34

### Assistant

- home page 7

## B

### Bevelled Carving 429

### Bezier Curve

- converting to a line 176
- converting to an arc 178
- inserting a point 179
- inserting a start point 180
- removing 181

### Bitmap Line Tool 144

### Bitmaps

- adding to the colour palette 137
- bitmap line tool 144
- contrast in 2D View window 18
- converting into vectors 147
- definition 4
- edge marking 135
- erase tool 144
- flood filling 145
- linking primary and secondary
  - colours 17, 134
- overview 129
- selective flood filling 145
- selective painting 143
- setting the origin 130
- setting the size 130
- showing and hiding 16
- spot filters 70
- thickening colour 136
- thinning colour 135
- toolbar 129

### Blended 3D shapes 374

### Border 225

### Bridges

- overview 528

## C

### Calculating

- batch of toolpaths 549
- machining time 551
- single toolpath 548

### Calculating reliefs

- adding 326
- merging 330
- subtracting 328
- Centreline Engraved Feature 281
- Centring vectors 258
- Circle
  - creating 159
  - editing 160
- Climb Milling 404
- Clipping Vectors 266
- Closing
  - vectors 265
- Colour
  - adding to colour palette 137
  - edge marking 135
  - linking primary and secondary 134
  - thickening 136
  - thinning 135
  - unlinking primary and secondary 134
- Colour Palette
  - adding colours 137
  - loading 139
  - saving 139
- Colours
  - link all 17
  - merge 18
  - unlink all 17
- Conventional Milling 403
- Converting
  - bitmap into vectors 147
  - feature to a vector 282
  - span to a bezier curve 177
  - span to a line 176
  - span to an arc 178
  - vectors to circles 224
  - vectors to rectangles 224
- Creating
  - 3D shape from bitmap 286
  - 3D shape from vector 290
  - angled plane 371
  - arc 169
  - bitmaps from vectors 275

- blended shapes 374
- border around vectors 225
- centreline engraved feature 281
- circle 159
- cross-section 370
- dome 323
- drill holes 476
- ellipse 161
- layers 110
- models from an image 47
- multiplate 96
- pocket 448
- polygon 164
- raised feature 277
- recessed feature 280
- rectangle 156
- ring 390
- star 166
- stepped pocket 458
- toolpath panels 523
- toolpath template 564
- vector text 230
- Cut Direction 403

## D

- Deleting
  - material 564
  - points 187
  - span 181
  - toolpath simulation 577
- Deskewing 67
- Distorting Vectors 218
- Dome 323
- Draft Angle 368
- Draw X Y 30
- Draw Zero Plane 30
- Drilling 476

## E

- Edge Marking 135
- Editing

- 3D shape attributes applied to bitmap
  - 289
- 3D shape attributes applied to vector
  - 293
- asymmetrical model dimensions 63
- circle 160
- distorted vectors 222
- ellipse 162
- machining parameters 540, 542
- polygon 165
- polyline 155
- rectangle 157
- relief height 354
- star 167
- start position in a toolpath 533
- toolpaths 545
- vector nodes 182
- vector points 182
- vector spans 175
- vector text 231
- vectors 171

Ellipse

- creating 161
- editing 162

Engraving 434

Envelope Distortion 218

- reliefs 378

Erase Tool 144

## **F**

- Face Wizard 122
- Feature Machining 486
- Fillet
  - inserting 203
- Fitting arcs to vectors 211
- Flood Fill 145
- Flood Fill Selective 145

## **G**

- Grouped Vectors 275
- Grouping Vectors 270

- Guidelines
  - positioning 23

## **H**

- Hiding
  - toolpaths 575

## **I**

- Importing
  - toolpath data 566
  - vector artwork 81
- Inlay Wizard
  - female inlay pocket 448
  - female stepped pocket inlay 458
  - overview 447
- Inserting
  - fillets 203
- ISO-FORM Letters 320
- Isometric View 29

## **J**

- Joining
  - vectors with coincident points 263

## **L**

- Layers
  - creating 110
  - overview 110
- Lead moves 535
- Light and Material Settings
  - lights 71
  - material 75
- Line
  - converting to a bezier curve 177
  - converting to an arc 178
  - inserting a point 179
  - inserting a start point 180
  - removing 181
- Linking Colours 134
- Loading



- custom colour palette 139
- reliefs 363
- toolpath simulation from relief 578

Locking

- vectors 211

## M

Machine Vectors 441

Maintenance 34

Material Setup 562

Merging

- colours 18
- reliefs 330
- toolpaths 521

Mirror

- model 105
- relief 357
- vectors 254

Models

- adding borders 69
- adjusting material setup 562
- clearing 67
- creating from an image 47
- creating layers 110
- deskewing 67
- editing asymmetrical dimensions 63
- importing images 61
- importing unwrapped triangle
  - models 92
- importing vector artwork 81
- layers 110
- loading toolpath data 566
- mirroring 105
- printing 57, 106
- rotating 105
- saving 55
- setting position 65

Moving

- points 184

Multiplate Tool 96

## N

Nesting Vectors 212

Node editing 182

Nodes

- moving 184

## O

Objects To Draw 30

Offset

- relief 359

Offset Vector 197

Origin

- setting position 65

## P

Paint Brush

- selective painting 143

Pan View 28

Panelling 523

Paste

- relief along a vector 349
- vectors along a curve 223

Peck Drilling 477

Pocket 448

Point

- aligning 190
- changing position 189
- changing the start point 189
- deleting 187
- editing 182
- inserting 179
- smoothing 185

Points

- identifying coincident 226
- joining coincident 263
- moving 184

Polygon

- creating 164, 165
- editing 165

Polyline

- editing 155

Previous View 29  
Print  
  model 106  
  preview 107  
  setup 108  
Profiling 407  
Properties of a Vector 272

## R

Raised Feature 277  
Ramping Moves 404  
Recessed Feature 280  
Rectangle  
  creating 156  
  editing 157  
Reliefs  
  adding 326  
  adding a draft angle 368  
  calculation time 367  
  copy and paste 344  
  creating a cross-section 370  
  creating a ring 390  
  creating an angled plane 371  
  creating blended shapes 374  
  definition 5  
  detail in 3D view 29  
  envelope distortion 378  
  face wizard 122  
  loading 363  
  merging 330  
  mirroring 357  
  offset 359  
  pasting along a vector 349  
  removing holes in surface 402  
  resetting 360  
  resetting height 360  
  scaling 356  
  scaling height 354  
  sculpting tools 397  
  smoothing 352  
  subtracting 328  
  wrapping clipart relief 338

  wrapping vectors to 209  
Ring 390  
Rotate  
  model 105  
Rulers 20

## S

Saving  
  3D view as an image 56  
  custom colour palette 139  
  model 55  
  tool groups database 562  
  toolpath simulation 577  
Scale To Fit 29  
Sculpting Tools 397  
Select Relief Details 29  
Selecting  
  toolpaths 509  
  vector objects 172  
Selective Painting 143  
Showing Toolpaths 576  
Simulating  
  toolpaths in 2D View 568  
  toolpaths in 3D View 570  
Simulation  
  2d view 568  
  3d view 570  
Slicing Vectors 268  
Smooth  
  nodes 185  
  points 185  
  relief 352  
  vectors 185  
Span  
  converting to a bezier curve 177  
  converting to a line 176  
  converting to an arc 178  
  deleting 181  
  inserting a point 179  
  inserting start point 180  
Splining Vectors 199  
Spot Filters 70

Star  
   creating 166  
   editing 167  
 Start Point  
   changing 189  
 Start Position 533  
 Stepped Pocket 458  
 Swept Profile Shape  
   extruding 295  
   spinning 301  
   turning 307

**T**

Thickening Colours 136  
 Thinning Colour 135  
 Tool Groups Database  
   adding tool groups 559  
   saving changes 562  
   using 554  
 Toolpath Ordering 537  
 Toolpath Panelling 523  
 Toolpath Summary  
   calculating machining time 551  
   using 550  
 Toolpath Template  
   creating 564  
   loading 565  
 Toolpaths  
   2D area clearance 417  
   add bridges to a profile pass 528  
   add lead moves to a profile pass 535  
   bevelled carving 429  
   calculating 548  
   calculating in a batch 549  
   changing the start position 533  
   creating a template 564  
   cut direction 403  
   deleting a simulation 577  
   drilling holes 476  
   editing 545  
   engraving 434  
   hiding 575  
   inlay wizard 447  
   lead moves 535  
   loading a template 565  
   loading toolpath data 566  
   machine vectors 441  
   machining order of profile passes 537  
   machining parameters 540, 542  
   merging 521  
   panelling 523  
   peck drilling 477  
   ramping moves 404  
   resetting a simulation 576  
   resetting machining order 539  
   selecting 509  
   showing 576  
   simulating 567  
   tool groups database 554  
   toolpath summary 550  
   v-bit carving 423  
   viewing 573  
 Transform  
   vectors 246  
 Transform Vectors Mode 244  
 Trim Tool 207  
 Twiddle Tool 27  
 Two Rail Sweep 310

**U**

Ungrouped vectors 274  
 Unlinking Colours 134  
 Unlocking  
   vectors 211

**V**

V-Bit Carving 423  
 Vector Doctor  
   coincident points 226  
 Vector Library 84  
 Vector Text  
   aligning 241

- creating 230
- editing 231
- formatting 233
- selecting 231
- spacing 243
- wrapping round a curve 238

## Vectors

- aligning 257
- aligning points 190
- centring 258
- changing the start point 189
- clipping 266
- closing 265
- converting into bitmaps 275
- converting shapes 224
- converting span to a bezier curve 177
- converting span to a line 176
- converting span to an arc 178
- copying and pasting 192
- creating a border 225
- creating a centreline engraved feature 281
- creating a circle 159
- creating a polygon 164
- creating a raised feature 277
- creating a recessed feature 280
- creating a rectangle 156
- creating a star 166
- creating an arc 169
- creating an ellipse 161
- creating text 230
- definition 3
- deleting points 187
- deleting spans 181
- distorting 218
- editing 171, 175
- editing a circle 160, 162
- editing a polygon 165
- editing a rectangle 157
- editing a star 167
- editing nodes 182
- editing points 182

- editing vector text 231
- filleting 203
- fitting arcs 211
- formatting vector text 233
- grouped 275
- grouping 270
- importing 81, 84
- inserting points 179
- inserting start point 180
- joining coincident points 263
- library 84
- locking 211
- loop detection and removal 81, 227
- making a multiplate 96
- mirroring 254
- nesting 212
- offsetting 197
- overview 151
- paste relief along 349
- pasting along a curve 223
- returning a feature to a vector 282
- selecting 172
- showing and hiding 16
- slicing 268
- smoothing points 185
- snapping 25
- splining 199, 203
- transform origin 247
- trimming 207
- ungrouped 274
- unlocking 211
- viewing properties 272
- wrapping text around a curve 238
- wrapping to a relief 209

View Along X 29

View Along Y 29

View Along Z 29

Viewing a toolpath 573

## W

Weave Shape 316

# Z

Zoom 28

Zoom Out 28