



**KT KEBLE'S**  
TRADING PTY LTD  
SERVICING INDUSTRY SINCE 1986



# STAINLESS STEEL NUTS & BOLTS CATALOGUE 2005

Interstate callers **1800 067 687**

**DANDENONG**  
Tel (03) 9794 5570  
Fax (03) 9791 3212  
Unit 1/28 Johnston Court  
Dandenong Vic 3175

**CAMPBELLFIELD**  
Tel (03) 9357 9611  
Fax (03) 9357 9488  
Unit 6, 1880 Hume Highway  
Campbellfield Vic 3061

**KILSYTH**  
Tel (03) 9761 4125  
Fax (03) 9761 4286  
Unit 1, 120 Canterbury Road  
Kilsyth Vic 3137

Visit our website: [www.keblestrading.com.au](http://www.keblestrading.com.au)  
Email: [keblestrading@bigpond.com](mailto:keblestrading@bigpond.com)

## Section 1 Bolt Products

Article No.	Name	Page No.
9312	Hexagon Head Bolts	1-2
9314	Hexagon Head Bolts	3
7095	Hexagon Head Bolts	4
7090	Hexagon Head Bolts	5
9332	Hexagon Head Set Screws	6-7
9334	Hexagon Head Set Screws	8
7096	Hexagon Head Set Screws	9
7091	Hexagon Head Set Screws	10
6032	Coach Bolts	11
6034	Coach Bolts	12
5712	Hexagon Head Coach Screws	13
5714	Hexagon Head Coach Screws	14

## Section 2 Socket Products

Article No.	Name	Page No.
9122	Hexagon Socket Head Cap Screws	17
9124	Hexagon Socket Head Cap Screws	18
7097	Socket Head Cap Screws	19
7098	Socket Head Cap Screws	20
7380 2	Button Head Socket Screws	21
7380 4	Button Head Socket Screws	21
7386	Button Head Socket Screws	22
7991 2	Countersunk Socket Head Screws	23
7991 4	Countersunk Socket Head Screws	24
7996	Countersunk Socket Head Screws	25
6912 2	Low Head Cap Screws	26
9480 2	Button Head Torx Socket Screws	26

## Section 3 Metal Thread Products

Article No.	Name	Page No.
0852	Pan Head Slotted Screws	29
9652	Countersunk Head Cross Recessed Screws	30
9654	Countersunk Head Cross Recessed Screws	31
9632	Countersunk Head Slotted Screws	32
7985 2	Pan Head Cross Recessed Screws	33
7985 4	Pan Head Cross Recessed Screws	34
7283	Pan Head Cross Recessed Machine Screws	35
7293	Pan Head Cross Recessed Machine Screws	36
7281	Countersunk Cross Recessed Machine Screws	37
7298	Countersunk Cross Recessed Machine Screws	38
7286	Countersunk Slotted Machine Screws	39

## Section 4 Self Tappers & Wood Screw Products

Article No.	Name	Page No.
7981 2	Pan Head Cross Recessed Self Tappers	41
7981 4	Pan Head Cross Recessed Self Tappers	42
7982 2	Countersunk Cross Recessed Self Tappers	43
7982 4	Countersunk Cross Recessed Self Tappers	44
7983 2	Cross Recessed Raised Countersunk Self Tappers	45
7971 2	Pan Head Slotted Self Tappers	46
7972 2	Countersunk Head Slotted Self Tappers	47
9100 2	Chipboard Screws	48
9105 2	Chipboard Screws	49
7100	Bugle Batten Screws	49

Product details and availability subject to change without notice.

DANDENONG  
CAMPBELLFIELD  
KILSYTH

TEL (03) **9794 5570**  
TEL (03) **9357 9611**  
TEL (03) **9761 4125**

FAX (03) 9791 3212  
FAX (03) 9357 9488  
FAX (03) 9761 4286

***"We have the right product at the right price, when you need it, on-time, everytime"***

## Section 5 Nut Products

Article No.	Name	Page No.
9342	Hexagon Nuts	51
9345 2	Hexagon Flange Nuts	52
9344	Hexagon Nuts	52
7322	Hexagon Nuts	53
7326	Hexagon Nuts	53
4392	Hexagon Thin Nuts	54
4394	Hexagon Thin Nuts	54
7334	Hexagon Thin Nuts	54
9852	Nylon Insert Nuts	55
9854	Nylon Insert Nuts	55
7325	Nylon Insert Nuts	56
7397	Nylon Insert Nuts	56
1587 2	Dome Nuts	57
1587 4	Dome Nuts	57
7324	Dome Nuts	57
3152	Wing Nuts	58
7342	Wing Nuts	58
3154	Wing Nuts	59
7344	Wing Nuts	59

## Section 6 Washer Products

Article No.	Name	Page No.
1252	Flat Washers	61
1254	Flat Washers	62
7409	Flat Washers	63
7412	Flat Washers	63
9021 2	Penny Washers	64
9021 4	Penny Washers	64
1458	Cup Washers	65
1272	Spring Washers	66
1274	Spring Washers	66
7445	Spring Washers	67
7447	Spring Washers	67
6797 22	External Toothed Washers	68
6797 12	Internal Toothed Washers	68

## Section 7 Miscellaneous

Article No.	Name	Page No.
4712	External Circlips	71
4722	Internal Circlips	72
0942	Split Pins	73
7761	Threaded Rod	73
9761 2	Threaded Rod	74
9761 4	Threaded Rod	74
9162	Grub Screws	75
9164	Grub Screws	75
	Rivets - Domed Head	75
7917	Rivet Nuts	76
7538	Hose Clamps	77

Product details and availability subject to change without notice.

DANDENONG	TEL (03) <b>9794 5570</b>	FAX (03) 9791 3212
CAMPBELLFIELD	TEL (03) <b>9357 9611</b>	FAX (03) 9357 9488
KILSYTH	TEL (03) <b>9761 4125</b>	FAX (03) 9761 4286

***"We have the right product at the right price, when you need it, on-time, everytime"***

# **BOLT PRODUCTS**

section  
**one**

# Hexagon Head Bolts

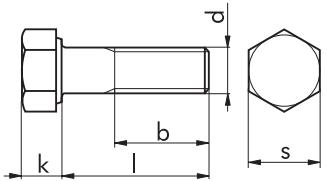
<b>DIN 931</b> (ISO 4014)  Grade A2 / 304		<b>HEXAGON HEAD BOLTS</b>  ArticleNo. 9312 (d x l)
--	---	---

b(Upto125mm)	16	18	22	26	30	34
b(Over125mm)	22	24	28	32	36	40
k	3.5	4	5.3	6.4	7.5	8.8
s	8	10	13	17	19	22

l	d	M5	M6	M8	M10	M12	M14
8							
10							
12							
16							
20							
25							
30			•				
35			•	•	•		
40			•	•	•	•	
45			•	•	•	•	
50			•	•	•	•	
55			•	•	•	•	
60			•	•	•	•	
65			•	•	•	•	
70			•	•	•	•	
75			•	•	•	•	
80			•	•	•	•	
85				•	•		
90			•	•	•	•	
95							
100			•	•	•	•	
110				•	•	•	
120				•	•	•	
130				•	•	•	
140				•	•	•	
150				•	•	•	
160					•	•	
170						•	
180						•	
200							

Product details and availability subject to change without notice.

DANDENONG  
 CAMPBELLFIELD  
 KILSYTH

TEL (03) **9794 5570**  
 TEL (03) **9357 9611**  
 TEL (03) **9761 4125**

FAX (03) 9791 3212  
 FAX (03) 9357 9488  
 FAX (03) 9761 4286

**“We have the right product at the right price, when you need it, on-time, everytime”**

# Hexagon Head Bolts

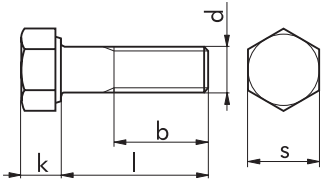
<b>DIN 931</b> (ISO 4014)  Grade A2 / 304		<b>HEXAGON HEAD BOLTS</b>  Article No. 9312 (d x l)
--	---	--

b (Up to 125mm)	38	46	54	60	66	78
b (Over 125mm)	44	52	60	66	72	84
k	10	12.5	15	17	18.7	22.5
s	24	30	36	41	46	55

l	d	M16	M20	M24	M27	M30	M36
8							
10							
12							
16							
20							
25							
30							
35							
40							
45							
50		•					
55		•					
60		•	•				
65		•	•				
70		•	•				
75		•	•				
80		•	•	•			
85		•	•				
90		•	•	•			
95							
100		•	•	•			
110		•	•	•			
120		•	•	•			
130		•	•	•			
140		•	•	•			
150		•	•				
160		•	•				
170		•	•				
180		•	•				
200		•	•				

Product details and availability subject to change without notice.

DANDENONG  
 CAMPBELLFIELD  
 KILSYTH

TEL (03) **9794 5570**  
 TEL (03) **9357 9611**  
 TEL (03) **9761 4125**

FAX (03) 9791 3212  
 FAX (03) 9357 9488  
 FAX (03) 9761 4286

***“We have the right product at the right price, when you need it, on-time, everytime”***

# Hexagon Head Bolts

**DIN 931**  
(ISO 4014)

Grade A4 / 316

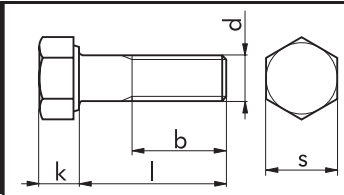

**HEXAGON HEAD  
BOLTS**

Article No.  
9314 (d x l)

b(125-200)	24	28	32	36	38	46	54	n/a
b(200+)			45	49	44	52	60	n/a
k	4	5.3	6.4	7.5	10	12.5	15	n/a
s	10	13	17	19	24	30	36	n/a

l	d	M6	M8	M10	M12	M16	M20	M24	M30
8									
10									
12									
16									
20									
25									
30									
35		•	•						
40		•	•	•					
45			•	•	•				
50		•	•	•	•	•			
55			•	•	•	•			
60		•	•	•	•	•	•		
65			•	•	•	•	•		
70		•	•	•	•	•	•		
75			•	•	•	•	•		
80			•	•	•	•	•	•	
85									
90			•	•	•	•	•	•	
95									
100			•	•	•	•	•	•	
110				•	•	•	•	•	•
120			•	•	•	•	•	•	
130					•	•	•		
140					•	•	•		
150						•	•		
160						•	•		

Product details and availability subject to change without notice.

DANDENONG  
CAMPBELLFIELD  
KILSYTH

TEL (03) **9794 5570**  
TEL (03) **9357 9611**  
TEL (03) **9761 4125**

FAX (03) 9791 3212  
FAX (03) 9357 9488  
FAX (03) 9761 4286

**“We have the right product at the right price, when you need it, on-time, everytime”**

# Hexagon Head Bolts

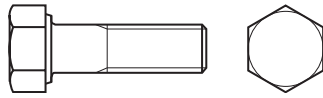
ANSI B18.2.1		<b>HEXAGON HEAD BOLTS</b>  ArticleNo. 7095 (d x l)
Grade A2 / 304		

l	d	1/4	5/16	3/8	1/2		
1/4"							
1/2"							
3/4"							
1"							
1 1/4"		•	•				
1 1/2"		•	•	•			
1 3/4"		•	•	•	•		
2"		•	•	•	•		
2 1/4"		•	•	•	•		
2 1/2"		•	•	•	•		
2 3/4"		•	•	•	•		
3"		•	•	•	•		
3 1/4"							
3 1/2"		•	•	•	•		
3 3/4"							
4"		•	•	•	•		
4 1/4"							
4 1/2"		•	•				
4 3/4"							
5"		•	•				
5 1/4"							
5 1/2"			•				
5 3/4"							
6"							
6 1/4"							
6 1/2"							
6 3/4"							
7"							
7 1/4"							
7 1/2"							
7 3/4"							

Product details and availability subject to change without notice.

DANDENONG  
CAMPBELLFIELD  
KILSYTH

TEL (03) **9794 5570**  
TEL (03) **9357 9611**  
TEL (03) **9761 4125**

FAX (03) 9791 3212  
FAX (03) 9357 9488  
FAX (03) 9761 4286

***"We have the right product at the right price, when you need it, on-time, everytime"***

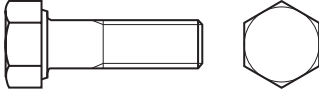

# Hexagon Head Bolts

ANSI B18.2.1		<b>HEXAGON HEAD BOLTS</b>  Article No. <b>7090 (d x l)</b>
Grade A4 / 316		

l	d	1/4	5/16	3/8	1/2		
1/4"							
1/2"							
3/4"							
1"							
1 1/4"		•	•				
1 1/2"		•	•	•			
1 3/4"		•	•	•	•		
2"		•	•	•	•		
2 1/4"		•	•	•	•		
2 1/2"		•	•	•	•		
2 3/4"		•	•	•	•		
3"		•	•	•	•		
3 1/4"							
3 1/2"		•	•	•	•		
3 3/4"							
4"		•	•	•	•		
4 1/4"							
4 1/2"		•	•	•			
4 3/4"							
5"		•	•	•			
5 1/4"							
5 1/2"			•	•			
5 3/4"							
6"				•			
6 1/4"							
6 1/2"							
6 3/4"							
7"							
7 1/4"							
7 1/2"							
7 3/4"							

Product details and availability subject to change without notice.

DANDENONG  
 CAMPBELLFIELD  
 KILSYTH

TEL (03) **9794 5570**  
 TEL (03) **9357 9611**  
 TEL (03) **9761 4125**

FAX (03) 9791 3212  
 FAX (03) 9357 9488  
 FAX (03) 9761 4286

**"We have the right product at the right price, when you need it, on-time, everytime"**

# Hexagon Head Set Screws

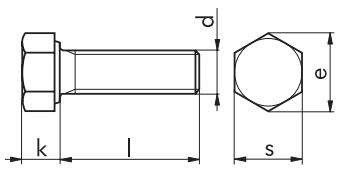
<b>DIN 933</b> (ISO 4017)  Grade A2 / 304		<b>HEXAGON HEAD SET SCREWS</b>  Article No. 9332 (d x l)
--	---	---

k	2	2.8	3.5	4	5.3	6.4	7.5
e	6.01	7.66	8.79	11.05	14.38	18.9	21.1
s	5.5	7	8	10	13	17	19

l	d	M3	M4	M5	M6	M8	M10	M12
6		•	•	•				
8		•	•	•	•			
10		•	•	•	•	•		
12			•	•	•	•	•	
14				•	•	•		
16		•	•	•	•	•	•	•
18					•	•		
20		•	•	•	•	•	•	•
22					•	•		
25		•	•	•	•	•	•	•
30			•	•	•	•	•	•
35			•	•	•	•	•	•
40			•	•	•	•	•	•
45				•	•	•	•	•
50			•	•	•	•	•	•
55				•	•	•	•	•
60				•	•	•	•	•
65					•	•	•	•
70						•	•	•
75					•	•	•	•
80					•	•	•	•
85								
90					•	•	•	•
95								
100					•	•	•	•
110							•	•
120							•	•
130								•
140								
150								•
160								•

Product details and availability subject to change without notice.

DANDENONG  
 CAMPBELLFIELD  
 KILSYTH

TEL (03) **9794 5570**  
 TEL (03) **9357 9611**  
 TEL (03) **9761 4125**

FAX (03) 9791 3212  
 FAX (03) 9357 9488  
 FAX (03) 9761 4286

***“We have the right product at the right price, when you need it, on-time, everytime”***

# Hexagon Head Set Screws

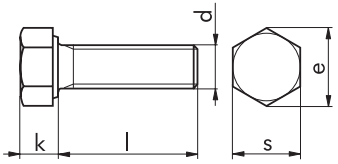
<b>DIN 933</b> (ISO 4017)  Grade A2 / 304		<b>HEXAGON HEAD SET SCREWS</b>  Article No. 9332 (d x l)
--	--	---

k	8.8	10	12.5	15	17	18.7	22.5
e	24.49	26.75	33.53	39.55	45.20	50.85	60.79
s	22	24	30	36	41	46	55

l	d	M14	M16	M20	M24	M27	M30	M36
6								
8								
10								
12								
16								
20			•					
25			•					
30			•	•				
35		•	•	•				
40		•	•	•				
45		•	•	•				
50			•	•	•			
55			•	•				
60		•	•	•	•			
65			•	•	•			
70			•	•	•			
75			•	•				
80				•	•			
85								
90			•	•	•			
95								
100			•	•	•			
110			•	•				
120			•	•				
130			•	•				
140								
150								
160								

Product details and availability subject to change without notice.

DANDENONG  
 CAMPBELLFIELD  
 KILSYTH

TEL (03) **9794 5570**  
 TEL (03) **9357 9611**  
 TEL (03) **9761 4125**

FAX (03) 9791 3212  
 FAX (03) 9357 9488  
 FAX (03) 9761 4286

**“We have the right product at the right price, when you need it, on-time, everytime”**

# Hexagon Head Set Screws

**DIN 933**  
(ISO 4017)

Grade A4 / 316

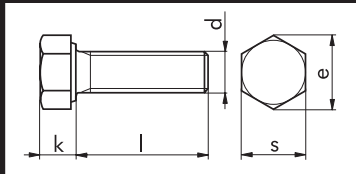

**HEXAGON HEAD  
SET SCREWS**

ArticleNo.  
9334 (d x l)

k	2.8	3.5	4	5.3	6.4	7.5	10	12.5	15	n/a	n/a
e	7.66	8.79	11.05	14.38	18.90	21.10	26.75	33.53	39.55	n/a	n/a
s	7	8	10	13	17	19	24	30	36	n/a	n/a

l	d	M4	M5	M6	M8	M10	M12	M16	M20	M24	M30	M36
8		•	•									
10		•	•	•	•							
12			•	•	•							
16		•	•	•	•	•						
20		•	•	•	•	•	•	•				
25			•	•	•	•	•	•				
30		•	•	•	•	•	•	•	•			
35				•	•	•	•	•	•			
40		•	•	•	•	•	•	•	•			
45				•	•	•	•	•	•			
50			•	•	•	•	•	•	•	•		
55					•	•	•	•	•			
60				•	•	•	•	•	•	•		
65								•	•			
70				•	•	•	•	•	•	•		
75					•		•	•	•			
80					•	•	•	•	•	•	•	
85												
90					•	•	•	•	•	•		•
95												
100					•	•	•	•	•	•		
110								•				
120						•	•	•	•			
130								•				
140												
150												

Product details and availability subject to change without notice.

DANDENONG  
CAMPBELLFIELD  
KILSYTH

TEL (03) **9794 5570**  
TEL (03) **9357 9611**  
TEL (03) **9761 4125**

FAX (03) 9791 3212  
FAX (03) 9357 9488  
FAX (03) 9761 4286

**"We have the right product at the right price, when you need it, on-time, everytime"**

# Hexagon Head Set Screws

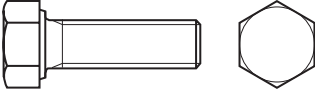
ANSI B18.2.1		<b>HEXAGON HEAD SET SCREWS</b>  ArticleNo. 7096 (d x l)
Grade A2 / 304		

l	d	1/4	5/16	3/8	1/2		
1/4"							
1/2"		•	•	•			
3/4"		•	•	•	•		
1"		•	•	•	•		
1 1/4"		•	•	•	•		
1 1/2"		•	•	•	•		
1 3/4"		•	•	•	•		
2"		•	•	•	•		
2 1/4"			•	•	•		
2 1/2"		•	•	•	•		
2 3/4"					•		
3"				•	•		
3 1/4"							
3 1/2"							
3 3/4"							
4"							
4 1/4"							
4 1/2"							
4 3/4"							
5"							
5 1/4"							
5 1/2"							
5 3/4"							
6"							
6 1/4"							
6 1/2"							
6 3/4"							
7"							
7 1/4"							

Product details and availability subject to change without notice.

DANDENONG  
CAMPBELLFIELD  
KILSYTH

TEL (03) **9794 5570**  
TEL (03) **9357 9611**  
TEL (03) **9761 4125**

FAX (03) 9791 3212  
FAX (03) 9357 9488  
FAX (03) 9761 4286

**"We have the right product at the right price, when you need it, on-time, everytime"**

# Hexagon Head Set Screws

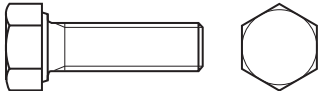
<p><b>ANSI B18.2.1</b></p> <p><b>Grade A4 / 316</b></p>		<p><b>HEXAGON HEAD SET SCREWS</b></p> <p>ArticleNo. 7091 (d x l)</p>
---	---	--

l	d	3/16	1/4	5/16	3/8	1/2	
1/4"							
1/2"		•	•	•	•		
3/4"		•	•	•	•	•	
1"		•	•	•	•	•	
1 1/4"		•		•	•	•	
1 1/2"		•	•	•	•	•	
1 3/4"			•	•	•	•	
2"		•		•	•	•	
2 1/4"					•	•	
2 1/2"		•	•	•	•	•	
2 3/4"							
3"		•	•	•	•	•	
3 1/4"							
3 1/2"			•		•	•	
3 3/4"							
4"			•		•	•	
4 1/4"							
4 1/2"							
4 3/4"							
5"							
5 1/4"							
5 1/2"							
5 3/4"							
6"							
6 1/4"							
6 1/2"							
6 3/4"							
7"							
7 1/4"							

Product details and availability subject to change without notice.

DANDENONG  
CAMPBELLFIELD  
KILSYTH

TEL (03) **9794 5570**  
TEL (03) **9357 9611**  
TEL (03) **9761 4125**

FAX (03) 9791 3212  
FAX (03) 9357 9488  
FAX (03) 9761 4286

***"We have the right product at the right price, when you need it, on-time, everytime"***

# Coach Bolts

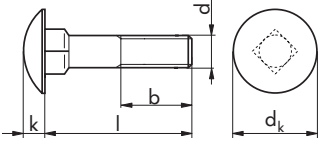
<b>DIN 603</b> (ISO 8677)  Grade A2 / 304		<b>COACH BOLTS WITHOUT NUTS</b>  ArticleNo. 6032 (d x l)
--	---	---

b(125)	16	18	22	26	30	38	
b(125-200)	22	24	28	32	36	44	
k	3.3	3.88	4.88	5.38	6.95	8.95	
dk	13.55	16.55	20.65	24.65	30.65	38.8	

l	d	M5	M6	M8	M10	M12	M16
16		•	•				
20		•	•	•			
25			•	•	•		
30		•	•	•	•		
35		•	•	•	•		
40		•	•	•	•	•	
45			•	•			
50		•	•	•	•	•	
55				•			
60			•	•	•		
70			•	•	•		
80			•	•			
90				•	•		
100			•	•	•		
110							
120				•	•		

Product details and availability subject to change without notice.

DANDENONG  
 CAMPBELLFIELD  
 KILSYTH

TEL (03) **9794 5570**  
 TEL (03) **9357 9611**  
 TEL (03) **9761 4125**

FAX (03) 9791 3212  
 FAX (03) 9357 9488  
 FAX (03) 9761 4286

**“We have the right product at the right price, when you need it, on-time, everytime”**

# Coach Bolts

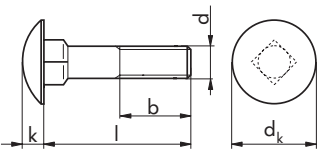
Grade A4 / 316		<b>COACH BOLTS WITHOUT NUTS</b>  Article No. 6034 (d x l)
----------------	---	--

b(125)	16	18	22	26	30	38	
b(125-200)	22	24	28	32	36	44	
k	3.3	3.88	4.88	5.38	6.95	8.95	
dk	13.55	16.55	20.65	24.65	30.65	38.8	

l	d	M5	M6	M8	M10	M12	M16
16							
20			•	•			
25			•	•	•		
30			•	•	•		
35					•		
40			•	•	•	•	
45							
50			•	•	•	•	
55							
60			•	•	•	•	
70			•	•	•		
80			•	•		•	
90							
100				•	•	•	
110							
120					•		
130						•	

Product details and availability subject to change without notice.

DANDENONG  
CAMPBELLFIELD  
KILSYTH

TEL (03) **9794 5570**  
TEL (03) **9357 9611**  
TEL (03) **9761 4125**

FAX (03) 9791 3212  
FAX (03) 9357 9488  
FAX (03) 9761 4286

***“We have the right product at the right price, when you need it, on-time, everytime”***

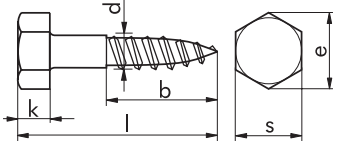

# Hexagon Head Coach Screws

<b>DIN 571</b>  Grade A2 / 304		<b>HEXAGON HEAD COACH SCREWS</b>  Article No. 5712 (d x l)
--------------------------------------	---	---

b		b>0.61	b>0.61	b>0.61	b>0.61	b>0.61	
k		3.5	4	5.5	7	8	
s		8	10	13	17	19	
e		8.63	10.89	14.2	18.72	20.88	

l	d	5mm	6mm	8mm	10mm	12mm	
25							
30			•				
35			•				
40		•	•	•			
45				•			
50		•	•	•	•	•	
60			•	•	•	•	
70			•	•	•	•	
80			•	•	•	•	
90				•	•		
100			•	•	•	•	
110							
120				•	•	•	
140				•	•		
160				•	•		

Product details and availability subject to change without notice.

DANDENONG  
CAMPBELLFIELD  
KILSYTH

TEL (03) **9794 5570**  
TEL (03) **9357 9611**  
TEL (03) **9761 4125**

FAX (03) 9791 3212  
FAX (03) 9357 9488  
FAX (03) 9761 4286

***"We have the right product at the right price, when you need it, on-time, everytime"***

# Hexagon Head Coach Screws

**DIN 571**

Grade A4/316

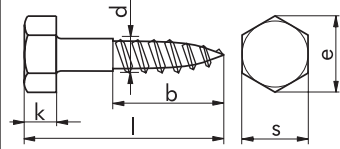
**HEXAGON HEAD  
COACH SCREWS**

 Article No.  
5714 (d x l)

b		b>0.61	b>0.61	b>0.61			
k		4	5.5	7	n/a		
s		10	13	17	n/a		
e		10.89	14.2	18.72	n/a		
l	d	6mm	8mm	10mm	12mm		
30		•					
40		•	•	•			
50		•	•	•	•		
60			•	•	•		
70			•	•	•		
80		•	•	•	•		
90					•		
100			•	•	•		
120			•	•	•		
130					•		

Product details and availability subject to change without notice.

 DANDENONG  
 CAMPBELLFIELD  
 KILSYTH

 TEL (03) **9794 5570**  
 TEL (03) **9357 9611**  
 TEL (03) **9761 4125**

 FAX (03) 9791 3212  
 FAX (03) 9357 9488  
 FAX (03) 9761 4286

**"We have the right product at the right price, when you need it, on-time, everytime"**

Product details and availability subject to change without notice.

DANDENONG  
CAMPBELLFIELD  
KILSYTH

TEL (03) **9794 5570**  
TEL (03) **9357 9611**  
TEL (03) **9761 4125**

FAX (03) 9791 3212  
FAX (03) 9357 9488  
FAX (03) 9761 4286

section  
**two**

# SOCKET PRODUCTS

# Hexagon Socket Head Cap Screws

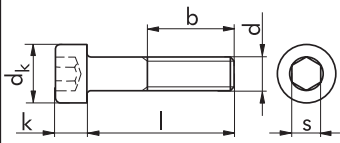
<b>DIN 912</b> (ISO 4762)  Grade A2 / 304		<b>HEXAGON SOCKET HEAD CAP SCREWS</b>  ArticleNo. 9122 (d x l)
--	--	---

b	17	18	20	22	24	28	32	36
s	2	2.5	3	4	5	6	8	10
k	2.5	3	4	5	6	8	10	12
dk	4.5	5.5	7	8.5	10	13	16	18

l	d	M2.5	M3	M4	M5	M6	M8	M10	M12
4			•						
5			•						
6		•	•	•	•				
8		•	•	•	•	•			
10		•	•	•	•	•	•		
12		•	•	•	•	•	•		
14			•	•	•	•			
16		•	•	•	•	•	•	•	•
18			•	•	•	•			
20			•	•	•	•	•	•	•
22					•		•		
25			•	•	•	•	•	•	•
30			•	•	•	•	•	•	•
35			•	•	•	•	•	•	•
40			•	•	•	•	•	•	•
45				•	•	•	•	•	•
50				•	•	•	•	•	•
55					•	•	•	•	•
60						•	•	•	•
65						•	•	•	
70						•	•	•	•
75						•	•		
80						•	•	•	•
90						•	•	•	•
100						•	•	•	•

Product details and availability subject to change without notice.

DANDENONG  
 CAMPBELLFIELD  
 KILSYTH

TEL (03) **9794 5570**  
 TEL (03) **9357 9611**  
 TEL (03) **9761 4125**

FAX (03) 9791 3212  
 FAX (03) 9357 9488  
 FAX (03) 9761 4286

**“We have the right product at the right price, when you need it, on-time, everytime”**

# Hexagon Socket Head Cap Screws

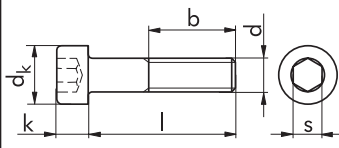
<b>DIN 912</b> (ISO 4762)  Grade A4 / 316		<b>HEXAGON          SOCKET HEAD          CAP SCREWS</b> ArticleNo. 9124 (d x l)
--	---	---

b	18	20	22	24	28	32	36
s	2.5	3	4	5	6	8	10
k	3	4	5	6	8	10	12
dk	5.5	7	8.5	10	13	16	18

l	d	M3	M4	M5	M6	M8	M10	M12
4								
5								
6		•	•					
8		•	•	•				
10		•	•	•	•	•		
12		•	•	•	•	•		
14								
16		•	•	•	•	•	•	
18								
20			•	•	•	•	•	•
25			•	•	•	•	•	•
30			•	•	•	•	•	•
35				•	•	•	•	•
40			•	•	•	•	•	•
45					•	•	•	•
50			•	•	•	•	•	•
55					•	•		
60					•	•	•	•
65								
70					•	•	•	•
80					•	•	•	•
90					•	•	•	
100						•	•	•

Product details and availability subject to change without notice.

DANDENONG  
 CAMPBELLFIELD  
 KILSYTH

TEL (03) **9794 5570**  
 TEL (03) **9357 9611**  
 TEL (03) **9761 4125**

FAX (03) 9791 3212  
 FAX (03) 9357 9488  
 FAX (03) 9761 4286

**“We have the right product at the right price, when you need it, on-time, everytime”**

# Socket Head Cap Screws

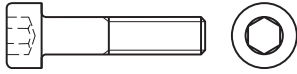
<b>ANSI B18.3</b>  <b>Grade A4 / 316</b>		<b>SOCKET HEAD CAP SCREWS</b>  <b>ArticleNo. 7097 (d x l)</b>
--	---	---

l	d	1/4	5/16	3/8			
1/4"							
3/8"							
1/2"		•	•				
5/8"							
3/4"		•	•	•			
1"		•	•	•			
1 1/4"							
1 3/8"							
1 1/2"		•	•	•			
1 5/8"							
1 3/4"							
2"			•	•			
2 1/4"							
2 3/8"							
2 1/2"							
2 5/8"							
2 3/4"							
3"							
3 1/4"							
3 3/8"							
3 1/2"							
3 5/8"							
3 3/4"							
4"							
4 1/4"							

Product details and availability subject to change without notice.

DANDENONG  
CAMPBELLFIELD  
KILSYTH

TEL (03) **9794 5570**  
TEL (03) **9357 9611**  
TEL (03) **9761 4125**

FAX (03) 9791 3212  
FAX (03) 9357 9488  
FAX (03) 9761 4286

***"We have the right product at the right price, when you need it, on-time, everytime"***

# Socket Head Cap Screws

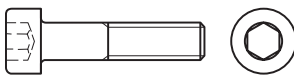
Grade A2 / 304		<p style="text-align: center; margin: 0;"><b>SOCKET HEAD CAP SCREWS</b></p> <p style="text-align: center; margin: 10px 0 0 0;">ArticleNo. 7098 (d x l)</p>
----------------	---	--

l	d	1/4	5/16	3/8	1-Feb		
1/4"							
3/8"							
1/2"							
5/8"							
3/4"		•	•	•	•		
1"		•	•	•	•		
1 1/4"		•	•	•	•		
1 3/8"							
1 1/2"		•	•	•	•		
1 5/8"							
1 3/4"		•	•	•	•		
2"		•	•	•	•		
2 1/4"		•	•	•	•		
2 3/8"							
2 1/2"		•	•	•	•		
2 5/8"							
2 3/4"							
3"		•	•	•	•		
3 1/4"							
3 3/8"							
3 1/2"							
3 5/8"							
3 3/4"							
4"							
4 1/4"							

Product details and availability subject to change without notice.

DANDENONG  
CAMPBELLFIELD  
KILSYTH

TEL (03) **9794 5570**  
TEL (03) **9357 9611**  
TEL (03) **9761 4125**

FAX (03) 9791 3212  
FAX (03) 9357 9488  
FAX (03) 9761 4286

***"We have the right product at the right price, when you need it, on-time, everytime"***

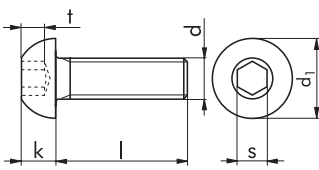

# Button Head Socket Screws

<b>ISO 7380</b>		<b>BUTTON HEAD SOCKET SCREWS</b>
Grade A2 / 304		ArticleNo. 7380 2 (d x l)

<b>t</b>	<b>1.35</b>	<b>1.3</b>	<b>1.56</b>	<b>2.08</b>	<b>2.6</b>	<b>3.12</b>
<b>s</b>	<b>2</b>	<b>2.5</b>	<b>3</b>	<b>4</b>	<b>5</b>	<b>6</b>
<b>k</b>	<b>1.6</b>	<b>2.2</b>	<b>2.7</b>	<b>3.3</b>	<b>4.4</b>	<b>5.5</b>
<b>d<sub>k</sub></b>	<b>5.5</b>	<b>7.6</b>	<b>9.5</b>	<b>10.5</b>	<b>14</b>	<b>17.5</b>

<b>l</b>	<b>d</b>	<b>M3</b>	<b>M4</b>	<b>M5</b>	<b>M6</b>	<b>M8</b>	<b>M10</b>
6		•	•				
8		•	•	•	•		
10		•	•	•	•	•	
12			•	•	•	•	
14							
16			•	•	•	•	
18							
20			•	•	•	•	•
22							
25			•	•	•	•	•
30				•	•	•	•
35				•	•		•
40				•	•	•	•
45							
50						•	•
55							
60					•	•	
70							•

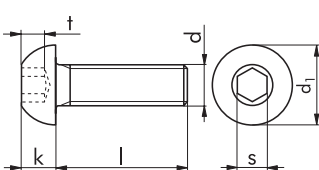
<b>Grade A4 / 316</b>		<b>BUTTON HEAD SOCKET SCREWS</b>
		ArticleNo. 7380 4 (d x l)

<b>l</b>	<b>d</b>	<b>M3</b>	<b>M4</b>	<b>M5</b>	<b>M6</b>	<b>M8</b>	<b>M10</b>
<b>30</b>				•			

Product details and availability subject to change without notice.

DANDENONG  
CAMPBELLFIELD  
KILSYTH

TEL (03) **9794 5570**  
TEL (03) **9357 9611**  
TEL (03) **9761 4125**

FAX (03) 9791 3212  
FAX (03) 9357 9488  
FAX (03) 9761 4286

**“We have the right product at the right price, when you need it, on-time, everytime”**

# Button Head Socket Screws

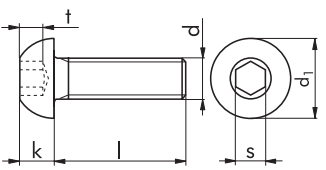
Grade A2 / 304		<b>BUTTONHEAD SOCKETSCREW</b>  ArticleNo. (7386 d x l)
----------------	---	---

l	d	3/16	1/4	5/16	3/8		
1/4"							
3/8"							
1/2"		•	•				
5/8"		•	•	•			
3/4"		•	•	•	•		
1"		•	•	•	•		
1 1/4"		•	•	•	•		
1 3/8"							
1 1/2"		•	•	•	•		
1 5/8"							
1 3/4"							
2"			•	•	•		
2 1/4"							
2 3/8"							
2 1/2"							
2 5/8"							
2 3/4"							
3"							

Product details and availability subject to change without notice.

DANDENONG  
CAMPBELLFIELD  
KILSYTH

TEL (03) **9794 5570**  
TEL (03) **9357 9611**  
TEL (03) **9761 4125**

FAX (03) 9791 3212  
FAX (03) 9357 9488  
FAX (03) 9761 4286

***"We have the right product at the right price, when you need it, on-time, everytime"***

# Countersunk Socket Head Screws

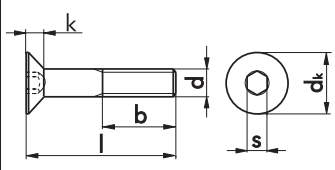
<b>DIN 7991</b> (ISO 10642)  Grade A2 / 304		<b>COUNTERSUNK          SOCKET HEAD          SCREWS</b> ArticleNo. 7991 2 (d x l)
--	---	---

<b>b</b>	12	14	16	18	22	26	30
<b>s</b>	2	2.5	3	4	5	6	8
<b>k</b>	1.7	2.3	2.8	3.3	4.4	5.5	6.5
<b>d<sub>k</sub></b>	6	8	10	12	16	20	24

l	d	M3	M4	M5	M6	M8	M10	M12
4								
5								
6		•	•					
8		•	•	•	•			
10		•	•	•	•	•		
12		•	•	•	•	•		
14				•	•			
16		•	•	•	•	•	•	
18								
20		•	•	•	•	•	•	•
25			•	•	•	•	•	•
30		•	•	•	•	•	•	•
35			•	•	•	•	•	•
40			•	•	•	•	•	•
45				•	•	•	•	
50			•	•	•	•	•	•
55					•	•		
60				•	•	•	•	•
65								
70				•	•	•	•	•
80					•	•	•	
90					•	•		
100								
120								
130								
140								
150								
160								

Product details and availability subject to change without notice.

DANDENONG  
 CAMPBELLFIELD  
 KILSYTH

TEL (03) **9794 5570**  
 TEL (03) **9357 9611**  
 TEL (03) **9761 4125**

FAX (03) 9791 3212  
 FAX (03) 9357 9488  
 FAX (03) 9761 4286

**“We have the right product at the right price, when you need it, on-time, everytime”**

# Countersunk Socket Head Screws

**DIN 7991**  
(ISO 10642)

Grade A4 / 316

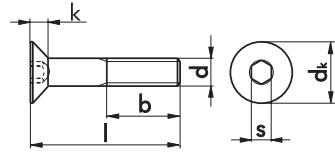

**COUNTERSUNK  
SOCKET HEAD  
SCREWS**  
ArticleNo.  
7991 4 (d x l)

b	12	14	16	18	22	26	30
s	2	2.5	3	4	5	6	8
k	1.7	2.3	2.8	3.3	4.4	5.5	6.5
dk	6	8	10	12	16	20	24

l	d	M3	M4	M5	M6	M8	M10	M12
4								
5								
6								
8			•	•				
10			•	•	•			
12			•	•	•	•		
14								
16			•	•	•	•		
18								
20			•	•	•	•	•	
25			•	•	•	•	•	•
30			•	•	•	•	•	•
35					•	•	•	•
40				•	•	•	•	•
45								
50					•	•	•	•
55								
60					•	•	•	•
65								
70						•		

Product details and availability subject to change without notice.

DANDENONG  
CAMPBELLFIELD  
KILSYTH

TEL (03) **9794 5570**  
TEL (03) **9357 9611**  
TEL (03) **9761 4125**

FAX (03) 9791 3212  
FAX (03) 9357 9488  
FAX (03) 9761 4286

**“We have the right product at the right price, when you need it, on-time, everytime”**

# Countersunk Socket Head Screws

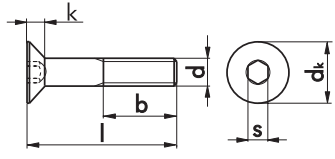
Grade A2 / 304		<b>COUNTERSUNK SOCKET HEAD SCREWS</b> Article No. 7996 (d x l)
----------------	---	--

l	d	3/16	1/4	5/16	3/8		
1/4"							
3/8"							
1/2"		•	•				
5/8"		•	•				
3/4"		•	•	•	•		
1"		•	•	•	•		
1 1/4"			•	•	•		
1 3/8"							
1 1/2"			•	•	•		
1 5/8"							
1 3/4"							
2"			•	•	•		
2 1/4"							
2 3/8"							
2 1/2"							
2 5/8"							
2 3/4"							
3"							

Product details and availability subject to change without notice.

DANDENONG  
 CAMPBELLFIELD  
 KILSYTH

TEL (03) **9794 5570**  
 TEL (03) **9357 9611**  
 TEL (03) **9761 4125**

FAX (03) 9791 3212  
 FAX (03) 9357 9488  
 FAX (03) 9761 4286

# Low Head Cap Screws

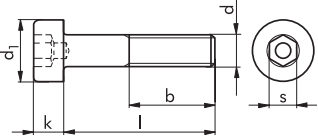
<p><b>DIN 6912</b></p> <p>Grade A2 / 304</p>		<p><b>LOW HEAD CAP SCREWS</b></p> <p>ArticleNo. 6912 2 (d x l)</p>
--	---	--

s	3	4	5	6	8	10
k	2.8	3.5	4	5	6.5	7.5
d <sub>1</sub>	7	8.5	10	13	16	18

l	d	M4	M5	M6	M8	M10	M12
8		•	•				
10		•	•	•			
12		•	•	•	•		
16			•	•	•		
20				•	•	•	
25				•	•	•	•
30				•	•		
35				•			
40					•		•

<p>Grade A2 / 304</p>		<p><b>BUTTONHEAD TORX SOCKET SCREWS</b></p> <p>ArticleNo. 9480 2 (d x l)</p>
-----------------------	---	--

l	d	M4	M5	M6	M8	M10	M12
10							
20						•	
25						•	
30						•	
35						•	
40						•	
50						•	

Product details and availability subject to change without notice.

DANDENONG  
CAMPBELLFIELD  
KILSYTH

TEL (03) **9794 5570**  
TEL (03) **9357 9611**  
TEL (03) **9761 4125**

FAX (03) 9791 3212  
FAX (03) 9357 9488  
FAX (03) 9761 4286

**“We have the right product at the right price, when you need it, on-time, everytime”**

Product details and availability subject to change without notice.

DANDENONG  
CAMPBELLFIELD  
KILSYTH

TEL (03) **9794 5570**  
TEL (03) **9357 9611**  
TEL (03) **9761 4125**

FAX (03) 9791 3212  
FAX (03) 9357 9488  
FAX (03) 9761 4286

section  
**three**

**METAL THREAD**

**PRODUCTS**

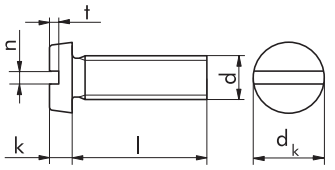

# Pan Head Slotted Screws

<b>DIN 85</b> (ISO 1580)  Grade A2 / 304		<b>PAN HEAD SLOTTED SCREWS</b>  ArticleNo. 0852 (d x l)
---	---	--

d <sub>k</sub>	6	8	10	12	16	20
k	1.8	2.4	3	3.6	4.8	6
n	0.8	1.2	1.2	1.6	2	2.5
t	0.7	1	1.2	1.4	1.9	2.4

l	d	M3	M4	M5	M6	M8	M10
4							
5							
6		•	•				
8		•	•	•			
10		•	•	•	•		
12			•	•	•		
16		•	•	•	•		
18							
20		•	•	•	•		
22							
25		•	•	•	•		
30				•	•		
35				•	•		
40					•		
45					•		
50					•		
55							
60							
65							
70							

Product details and availability subject to change without notice.

DANDENONG  
 CAMPBELLFIELD  
 KILSYTH

TEL (03) **9794 5570**  
 TEL (03) **9357 9611**  
 TEL (03) **9761 4125**

FAX (03) 9791 3212  
 FAX (03) 9357 9488  
 FAX (03) 9761 4286

**“We have the right product at the right price, when you need it, on-time, everytime”**

# Countersunk Head Cross Recessed Screws

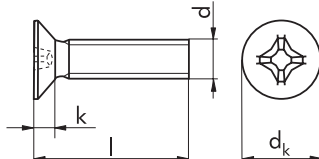
<b>DIN 965</b> (ISO 7046)  Grade A2 / 304		<b>COUNTERSUNK HEAD          CROSS RECESSED          SCREWS</b> ArticleNo. 9652 (d x l)
--	---	---

<b>d<sub>k</sub></b>	<b>4.7</b>	<b>5.6</b>	<b>7.5</b>	<b>9.2</b>	<b>11</b>	<b>14.5</b>	<b>18</b>
<b>k</b>	<b>1.5</b>	<b>1.65</b>	<b>2.2</b>	<b>2.5</b>	<b>3</b>	<b>4</b>	<b>5</b>
<b>Drive</b>	<b>H1</b>	<b>H1</b>	<b>H2</b>	<b>H2</b>	<b>H3</b>	<b>H4</b>	<b>H4</b>

<b>l</b>	<b>d</b>	<b>M2.5</b>	<b>M3</b>	<b>M4</b>	<b>M5</b>	<b>M6</b>	<b>M8</b>	<b>M10</b>
4			•					
5		•		•				
6		•	•	•	•			
8		•	•	•	•			
10			•	•	•	•		
12			•	•	•	•		
14					•	•		
16			•	•	•	•	•	
18								
20			•	•	•	•	•	
22								
25			•		•	•	•	
30				•	•	•	•	
35			•	•	•	•		
40			•	•	•	•	•	
45					•			
50				•	•	•	•	
55								
60					•	•		
65								
70					•	•		
80					•	•		
90								
100								

Product details and availability subject to change without notice.

DANDENONG  
 CAMPBELLFIELD  
 KILSYTH

TEL (03) **9794 5570**  
 TEL (03) **9357 9611**  
 TEL (03) **9761 4125**

FAX (03) 9791 3212  
 FAX (03) 9357 9488  
 FAX (03) 9761 4286

***“We have the right product at the right price, when you need it, on-time, everytime”***

# Countersunk Head Cross Recessed Screws

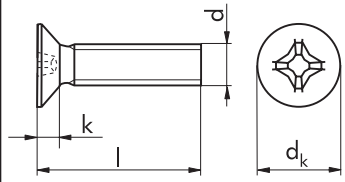
<b>DIN 965</b> (ISO 7046)  Grade A4 / 316		<b>COUNTERSUNK HEAD          CROSS RECESSED          SCREWS</b> ArticleNo. 9654 (d x l)
--	--	---

dk	4.7	5.6	7.5	9.2	11	14.5	18
k	1.5	1.65	2.2	2.5	3	4	5
Drive	H1	H1	H2	H2	H3	H4	H4

l	d	M2.5	M3	M4	M5	M6	M8	M10
4								
5								
6								
8								
10					•			
12				•	•	•		
14								
16				•	•	•		
18								
20				•	•	•	•	
22								
25					•	•	•	
30					•	•	•	
35								
40						•	•	
45							•	
50							•	
55								
60							•	

Product details and availability subject to change without notice.

DANDENONG  
 CAMPBELLFIELD  
 KILSYTH

TEL (03) **9794 5570**  
 TEL (03) **9357 9611**  
 TEL (03) **9761 4125**

FAX (03) 9791 3212  
 FAX (03) 9357 9488  
 FAX (03) 9761 4286

***“We have the right product at the right price, when you need it, on-time, everytime”***

# Countersunk Head Slotted Screws

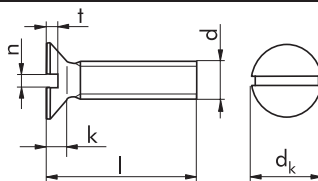
<b>DIN 963</b> (ISO 2009)  Grade A2 / 304		<b>COUNTERSUNK HEAD          SLOTTED SCREWS</b>  Article No. 9632 (d x l)
--	---	--

<b>d<sub>k</sub></b>	<b>5.6</b>	<b>7.5</b>	<b>9.2</b>	<b>11</b>	<b>14.5</b>	<b>18</b>
<b>k</b>	<b>1.7</b>	<b>2.2</b>	<b>2.5</b>	<b>3</b>	<b>4</b>	<b>5</b>
<b>n</b>	<b>0.8</b>	<b>1</b>	<b>1.2</b>	<b>1.6</b>	<b>2</b>	<b>2.5</b>
<b>t min</b>	<b>0.6</b>	<b>0.8</b>	<b>1</b>	<b>1.2</b>	<b>1.6</b>	<b>2</b>

<b>l</b>	<b>d</b>	<b>M3</b>	<b>M4</b>	<b>M5</b>	<b>M6</b>	<b>M8</b>	<b>M10</b>
6		•					
8		•	•	•	•		
10		•	•	•	•		
12		•	•	•	•		
16		•	•	•	•	•	
18							
20		•	•	•	•	•	•
22							
25			•	•	•	•	•
30		•	•	•	•	•	•
35				•	•	•	
40			•	•	•	•	•
45				•			
50				•	•	•	•
55							
60					•	•	•
65							•
70					•	•	•
75						•	•
80							
85							
90							
95							
100							
110							

Product details and availability subject to change without notice.

DANDENONG  
 CAMPBELLFIELD  
 KILSYTH

TEL (03) **9794 5570**  
 TEL (03) **9357 9611**  
 TEL (03) **9761 4125**

FAX (03) 9791 3212  
 FAX (03) 9357 9488  
 FAX (03) 9761 4286

***“We have the right product at the right price, when you need it, on-time, everytime”***

# Pan Head Cross Recessed Screws

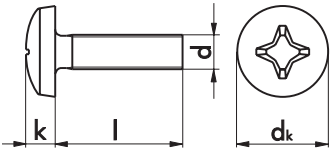
<b>DIN 7985</b> (ISO 7045)  Grade A2 / 304		<b>PAN HEAD          CROSS RECESSED          SCREWS</b> ArticleNo. 7985 2 (d x l)
---	---	---

$d_k$	5	6	8	10	12	16
k	2	2.4	3.1	3.8	4.6	6
Drive	H1	H1	H2	H2	H3	H4

l	d	M2.5	M3	M4	M5	M6	M8
4		•	•				
5		•	•	•			
6		•	•	•	•		
8		•	•	•	•	•	
10		•	•	•	•	•	
12		•	•	•	•	•	
14							
16			•	•	•	•	
18			•				
20			•	•	•	•	
22							
25			•	•	•	•	
30			•	•	•	•	
35				•	•	•	
40				•	•	•	
45					•		
50				•	•	•	
55							
60					•	•	
65							
70						•	
80							
90							
100							

Product details and availability subject to change without notice.

DANDENONG  
 CAMPBELLFIELD  
 KILSYTH

TEL (03) **9794 5570**  
 TEL (03) **9357 9611**  
 TEL (03) **9761 4125**

FAX (03) 9791 3212  
 FAX (03) 9357 9488  
 FAX (03) 9761 4286

**“We have the right product at the right price, when you need it, on-time, everytime”**

# Pan Head Cross Recessed Screws

**DIN 7985**  
(ISO 7045)

Grade A4 / 316

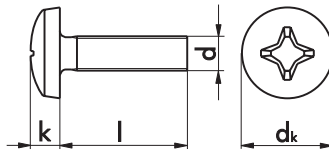

**PAN HEAD  
CROSS RECESSED  
SCREWS**  
ArticleNo.  
7985 4 (d x l)

dk	5	6	8	10	12	16
k	2	2.4	3.1	3.8	4.6	6
Drive	H1	H1	H2	H2	H3	H4

l	d	M2.5	M3	M4	M5	M6	M8
4							
5							
6				•			
8				•			
10				•			
12				•			
14							
16				•	•	•	
18					•		
20				•	•	•	•
22					•		
25					•	•	•
30						•	•
35					•		•
40						•	•
45							•
50					•	•	•
55							
60							•
65							
70							•
80							
90							
100							

Product details and availability subject to change without notice.



DANDENONG  
CAMPBELLFIELD  
KILSYTH

TEL (03) **9794 5570**  
TEL (03) **9357 9611**  
TEL (03) **9761 4125**

FAX (03) 9791 3212  
FAX (03) 9357 9488  
FAX (03) 9761 4286

***“We have the right product at the right price, when you need it, on-time, everytime”***

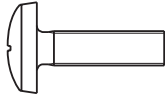
# Pan Head Cross Recessed Machine Screws

ANSI B18.2.1	 	<b>PAN HEAD CROSS RECESSED MACHINE SCREWS</b> ArticleNo. 7283 (d x l)
Grade A2 / 304		

l	d	3/16	1/4				
1/4"							
3/8"		•					
1/2"		•	•				
5/8"		•	•				
3/4"		•	•				
1"		•	•				
1 1/4"		•	•				
1 3/8"							
1 1/2"		•	•				
1 5/8"							
1 3/4"		•	•				
2"		•	•				
2 1/4"							
2 3/8"							
2 1/2"		•	•				
2 5/8"							
2 3/4"							
3"							
3 1/4"							
3 3/8"							
3 1/2"							
3 5/8"							
3 3/4"							
4"							
4 1/4"							

Product details and availability subject to change without notice.

DANDENONG  
CAMPBELLFIELD  
KILSYTH

TEL (03) **9794 5570**  
TEL (03) **9357 9611**  
TEL (03) **9761 4125**

FAX (03) 9791 3212  
FAX (03) 9357 9488  
FAX (03) 9761 4286

# Pan Head Cross Recessed Machine Screws

<b>ANSI B18.6.3</b>  <b>Grade A4 / 316</b>		<b>PAN HEAD CROSSRECESSED MACHINE SCREWS</b>  <b>Article No. 7293 (d x l)</b>
--	---	---

l	d	3/16	1/4				
1/4"							
3/8"							
1/2"		•					
5/8"		•					
3/4"		•	•				
1"		•	•				
1 1/4"		•	•				
1 3/8"							
1 1/2"		•	•				
1 5/8"							
1 3/4"		•	•				
2"		•	•				
2 1/4"							
2 3/8"							
2 1/2"		•					
2 5/8"							
2 3/4"							
3"		•					
3 1/4"							
3 3/8"							
3 1/2"							
3 5/8"							
3 3/4"							
4"							
4 1/4"							

Product details and availability subject to change without notice.

DANDENONG  
CAMPBELLFIELD  
KILSYTH



TEL (03) **9794 5570**  
TEL (03) **9357 9611**  
TEL (03) **9761 4125**

FAX (03) 9791 3212  
FAX (03) 9357 9488  
FAX (03) 9761 4286

***"We have the right product at the right price, when you need it, on-time, everytime"***

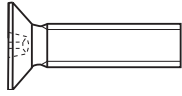

# Countersunk Cross Recessed Machine Screws

ANSI B18.6.3	 	<b>COUNTERSUNK CROSS RECESSED MACHINE SCREWS</b> ArticleNo. 7281 (d x l)
Grade A2 / 304		

l	d	3/16	1/4	5/16			
1/4"		•					
3/8"		•					
1/2"		•	•	•			
5/8"		•	•				
3/4"		•	•	•			
1"		•	•	•			
1 1/4"		•	•	•			
1 3/8"							
1 1/2"		•	•	•			
1 5/8"							
1 3/4"		•	•				
2"		•	•	•			
2 1/4"							
2 3/8"							
2 1/2"		•	•				
2 5/8"							
2 3/4"							
3"							
3 1/4"							
3 3/8"							
3 1/2"							
3 5/8"							
3 3/4"							
4"							
4 1/4"							

Product details and availability subject to change without notice.

DANDENONG  
CAMPBELLFIELD  
KILSYTH

TEL (03) **9794 5570**  
TEL (03) **9357 9611**  
TEL (03) **9761 4125**

FAX (03) 9791 3212  
FAX (03) 9357 9488  
FAX (03) 9761 4286

***"We have the right product at the right price, when you need it, on-time, everytime"***

# Countersunk Cross Recessed Machine Screws

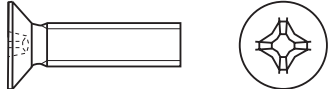
ANSI B18.6.3		<b>COUNTERSUNK CROSS RECESSED MACHINE SCREWS</b> ArticleNo. <b>7298 (d x l)</b>
Grade A4 / 316		

l	d	3/16"	1/4"				
1/4"							
3/8"							
1/2"		•					
5/8"		•					
3/4"		•	•				
1"		•	•				
1 1/4"		•	•				
1 3/8"							
1 1/2"		•	•				
1 5/8"							
1 3/4"		•	•				
2"		•	•				
2 1/4"							
2 3/8"							
2 1/2"		•					
2 5/8"							
2 3/4"							
3"		•					
3 1/4"							
3 3/8"							
3 1/2"							
3 5/8"							
3 3/4"							
4"							
4 1/4"							

Product details and availability subject to change without notice.

DANDENONG  
 CAMPBELLFIELD  
 KILSYTH

TEL (03) **9794 5570**  
 TEL (03) **9357 9611**  
 TEL (03) **9761 4125**

FAX (03) 9791 3212  
 FAX (03) 9357 9488  
 FAX (03) 9761 4286

***"We have the right product at the right price, when you need it, on-time, everytime"***

# Countersunk Slotted Machine Screws

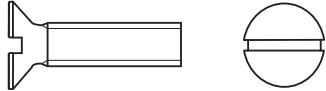
ANSI B18.6.3		<p style="text-align: center;">COUNTERSUNK SLOTTED MACHINE SCREWS</p> <p style="text-align: center;">ArticleNo. 7286 (d x l)</p>
Grade A2 / 304		

l	d	3/16	1/4	5/16	3/8		
1/4"							
3/8"		•	•				
1/2"		•	•	•	•		
5/8"		•	•	•			
3/4"		•	•	•	•		
1"		•	•	•	•		
1 1/4"		•	•	•	•		
1 3/8"							
1 1/2"		•	•	•	•		
1 5/8"							
1 3/4"		•	•	•	•		
2"		•	•	•	•		
2 1/4"							
2 3/8"							
2 1/2"							
2 5/8"							
2 3/4"							
3"							
3 1/4"							
3 3/8"							
3 1/2"							
3 5/8"							
3 3/4"							
4"							
4 1/4"							

Product details and availability subject to change without notice.

DANDENONG  
CAMPBELLFIELD  
KILSYTH

TEL (03) **9794 5570**  
TEL (03) **9357 9611**  
TEL (03) **9761 4125**

FAX (03) 9791 3212  
FAX (03) 9357 9488  
FAX (03) 9761 4286

***"We have the right product at the right price, when you need it, on-time, everytime"***

**SELF TAPPERS  
& WOOD SCREW  
PRODUCTS**

section  
**four**

# Pan Head Cross Recessed Self Tappers

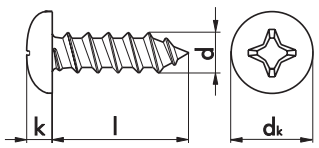
<b>DIN 7981</b> (ISO 7049)  Grade A2 / 304		<b>PAN HEAD          CROSS RECESSED          SELF TAPPERS</b>  Article No. 7981 2 (d x l)
---	---	--

<b>d</b>	2.9	3.5	3.9	4.2	4.8	5.5	6.3
<b>d<sub>k</sub></b>	5.6	6.9	7.5	8.2	9.5	10.8	12.5
<b>k</b>	2.2	2.6	2.8	3.05	3.55	3.95	4.55
<b>Drive</b>	H1	H2	H2	H2	H2	H3	H3

<b>l</b>	<b>d</b>	2.9	3.5	3.9	4.2	4.8	5.5	6.3
6.5		•	•					
9.5		•	•	•	•	•		
13		•	•	•	•	•	•	
16		•	•	•	•	•	•	•
19		•	•	•	•	•	•	•
22			•	•	•	•	•	
25		•	•	•	•	•	•	•
32			•	•	•	•	•	•
35								
38			•	•	•	•	•	•
41								
45				•	•	•	•	
50					•	•	•	•
57								
60						•	•	
63								
70						•	•	
76								
80						•		
90								
100								

Product details and availability subject to change without notice.

DANDENONG  
 CAMPBELLFIELD  
 KILSYTH

TEL (03) **9794 5570**  
 TEL (03) **9357 9611**  
 TEL (03) **9761 4125**

FAX (03) 9791 3212  
 FAX (03) 9357 9488  
 FAX (03) 9761 4286

**“We have the right product at the right price, when you need it, on-time, everytime”**

# Pan Head Cross Recessed Self Tappers

**DIN 7981**  
(ISO 7049)

Grade A4 / 316

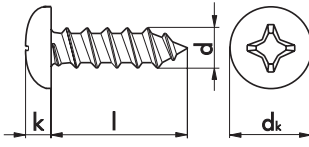

**PAN HEAD  
CROSS RECESSED  
SELF TAPPERS**

Article No.  
7981 4 (d x l)

d		n/a	3.5	3.9	4.2	n/a	n/a	n/a
dk		n/a	6.9	7.5	8.2	n/a	n/a	n/a
k		n/a	2.6	2.8	3.05	n/a	n/a	n/a
Drive		n/a	H2	H2	H2	n/a	n/a	n/a

l	d	2.9	3.5	3.9	4.2	4.8	5.5	6.3
6.5		•	•					
9.5		•	•	•	•	•		
13		•	•	•	•	•	•	
16		•	•	•	•	•	•	•
19		•	•	•	•	•	•	•
22			•	•	•	•	•	
25		•	•	•	•	•	•	•
32			•	•	•	•	•	•
35								
38			•	•	•	•	•	•
41								
45				•	•	•	•	
50					•	•	•	•
57								
60						•	•	
63								
70						•	•	
76								
80								
90								
100								

Product details and availability subject to change without notice.

DANDENONG  
CAMPBELLFIELD  
KILSYTH

TEL (03) **9794 5570**  
TEL (03) **9357 9611**  
TEL (03) **9761 4125**

FAX (03) 9791 3212  
FAX (03) 9357 9488  
FAX (03) 9761 4286

**“We have the right product at the right price, when you need it, on-time, everytime”**

# Countersunk Cross Recessed Self Tappers

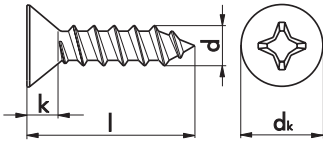
<b>DIN 7982</b> (ISO 7050)  Grade A2 / 304		<b>COUNTERSUNK          CROSS RECESSED          SELF TAPPERS</b>  Article No. 7982 2 (d x l)
---	--	---

<b>d<sub>k</sub></b>	<b>5.5</b>	<b>6.8</b>	<b>7.5</b>	<b>8.1</b>	<b>9.5</b>	<b>10.8</b>	<b>12.4</b>
<b>k</b>	<b>1.7</b>	<b>2.1</b>	<b>2.3</b>	<b>2.5</b>	<b>3</b>	<b>3.4</b>	<b>3.8</b>

<b>l</b>	<b>d</b>	<b>2.9</b>	<b>3.5</b>	<b>3.9</b>	<b>4.2</b>	<b>4.8</b>	<b>5.5</b>	<b>6.3</b>
6.5								
9.5		•	•	•	•			
13		•	•	•	•	•		
16		•	•	•	•	•		
19		•	•	•	•		•	•
22			•	•	•	•		
25		•	•	•	•	•	•	•
32			•	•	•	•	•	
35								
38			•	•	•	•	•	
41								
45				•	•	•		
50				•	•	•	•	•
55						•		
57								
60				•	•	•	•	
63								
70					•	•		
76							•	
80						•		
90								
100								

Product details and availability subject to change without notice.

DANDENONG  
 CAMPBELLFIELD  
 KILSYTH

TEL (03) **9794 5570**  
 TEL (03) **9357 9611**  
 TEL (03) **9761 4125**

FAX (03) 9791 3212  
 FAX (03) 9357 9488  
 FAX (03) 9761 4286

**“We have the right product at the right price, when you need it, on-time, everytime”**

# Countersunk Cross Recessed Self Tappers

**DIN 7982**  
(ISO 7050)

Grade A4/316

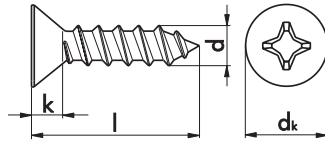

**COUNTERSUNK  
CROSS RECESSED  
SELF TAPPERS**

ArticleNo.  
7982 4 (d x l)

$d_k$		5.5	6.8	7.5	8.1	9.5	10.8	12.4
k		1.7	2.1	2.3	2.5	3	3.4	3.8

l	d	2.9	3.5	3.9	4.2	4.8	5.5	6.3
6.5								
9.5		•	•	•	•			
13		•	•	•	•	•	•	
16		•	•	•	•	•	•	
19		•	•	•	•	•	•	•
22			•	•	•	•		•
25		•	•	•	•	•	•	•
32			•	•	•	•	•	•
35								
38			•	•	•	•	•	•
41								
45				•	•	•	•	
50				•	•	•	•	•
55								
57								
60					•	•	•	
63								
70					•	•		
76								
80						•		
90								
100								

Product details and availability subject to change without notice.

DANDENONG  
CAMPBELLFIELD  
KILSYTH

TEL (03) **9794 5570**  
TEL (03) **9357 9611**  
TEL (03) **9761 4125**

FAX (03) 9791 3212  
FAX (03) 9357 9488  
FAX (03) 9761 4286

***"We have the right product at the right price, when you need it, on-time, everytime"***

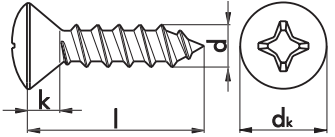

# Cross Recessed Raised Countersunk Self Tappers

<b>DIN 7983</b> (ISO 7051)  Grade A2 / 304		<b>CROSS RECESSED          RAISED COUNTERSUNK          SELF TAPPERS</b>  Article No. 7983 2 (d x l)
---	---	--

<b>d<sub>k</sub></b>	<b>5.5</b>	<b>6.8</b>	<b>7.5</b>	<b>8.1</b>	<b>9.5</b>	
<b>k</b>	<b>1.7</b>	<b>2.1</b>	<b>2.3</b>	<b>2.5</b>	<b>3</b>	
<b>drive</b>	<b>H1</b>	<b>H2</b>	<b>H2</b>	<b>H2</b>	<b>H2</b>	

<b>l</b>	<b>d</b>	<b>2.9</b>	<b>3.5</b>	<b>3.9</b>	<b>4.2</b>	<b>4.8</b>	
<b>9.5</b>		•					
<b>13</b>		•	•	•	•		
<b>16</b>		•	•	•	•	•	
<b>19</b>		•	•	•	•	•	
<b>22</b>					•	•	
<b>25</b>		•	•	•	•	•	
<b>32</b>			•		•	•	
<b>38</b>			•	•	•	•	
<b>50</b>						•	
<b>60</b>						•	

Product details and availability subject to change without notice.

DANDENONG  
 CAMPBELLFIELD  
 KILSYTH

TEL (03) **9794 5570**  
 TEL (03) **9357 9611**  
 TEL (03) **9761 4125**

FAX (03) 9791 3212  
 FAX (03) 9357 9488  
 FAX (03) 9761 4286

***“We have the right product at the right price, when you need it, on-time, everytime”***

# Pan Head Slotted Self Tappers

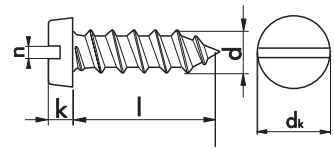
<b>DIN 7971</b> (ISO 1481)  Grade A2 / 304		<b>PAN HEAD          SLOTTED SELF          TAPPERS</b> Article No. 7971 2 (d x l)
---	---	---

$d_k$		5.6	6.9	8.2	9.5	10.8	
k		1.75	2.1	2.45	2.8	3.2	
n		0.8	1	1.2	1.2	1.6	

l	d	2.9	3.5	4.2	4.8	5.5	
6.5		•					
9.5		•	•	•	•	•	
13		•	•	•	•		
16		•	•	•	•		
19		•	•	•	•		
25		•	•	•	•	•	
32			•	•	•	•	
35							
38			•	•	•	•	
41							
45			•	•	•		
50				•	•	•	
57							
60							
63							
70							
76							
80							
90							

Product details and availability subject to change without notice.

DANDENONG  
 CAMPBELLFIELD  
 KILSYTH

TEL (03) **9794 5570**  
 TEL (03) **9357 9611**  
 TEL (03) **9761 4125**

FAX (03) 9791 3212  
 FAX (03) 9357 9488  
 FAX (03) 9761 4286

***“We have the right product at the right price, when you need it, on-time, everytime”***

# Countersunk Head Slotted Self Tappers

<b>DIN 7972</b> (ISO 1482)  Grade A2 / 304		<b>COUNTERSUNK HEAD SLOTTED SELF TAPPERS</b> ArticleNo. 7972 2 (d x l)
---	--	--

$d_k$		5.5	6.8	8.1	9.5		
k		1.7	2.1	2.5	3		
n		0.8	1	1.2	1.2		

l	d	2.9	3.5	4.2	4.8		
6.5							
9.5		•	•	•			
13		•	•	•	•		
16		•	•	•	•		
19		•	•	•	•		
25		•	•	•	•		
32			•	•	•		
35							
38			•	•	•		
41							
45			•				
50				•	•		
57							
60							
63							
70							
76							
80							

Product details and availability subject to change without notice.

DANDENONG  
CAMPBELLFIELD  
KILSYTH

TEL (03) **9794 5570**  
TEL (03) **9357 9611**  
TEL (03) **9761 4125**

FAX (03) 9791 3212  
FAX (03) 9357 9488  
FAX (03) 9761 4286

**“We have the right product at the right price, when you need it, on-time, everytime”**

# Chipboard Screws

<b>FULL THREAD</b>  Grade A2 / 304		<b>CHIPBOARD SCREWS</b>  Article No. 9100 2 (d x l)
--	---	--

l	d	3	3.5	4	4.5	5	6
16		•	•	•			
20		•	•	•	•	•	
25		•	•	•	•	•	
30		•	•	•	•	•	
35		•	•	•	•	•	
40			•	•	•	•	•
45				•	•	•	
50				•	•	•	•
60				•	•	•	•
70				•	•	•	•
80						•	•
90						•	•
100						•	•
110							
120							

Product details and availability subject to change without notice.

DANDENONG  
CAMPBELLFIELD  
KILSYTH

TEL (03) **9794 5570**  
TEL (03) **9357 9611**  
TEL (03) **9761 4125**

FAX (03) 9791 3212  
FAX (03) 9357 9488  
FAX (03) 9761 4286

***“We have the right product at the right price, when you need it, on-time, everytime”***

# Chipboard Screws

<b>WITH SHAFT</b>		<b>CHIPBOARD SCREWS</b>
Grade A2 / 304		Article No. 9105 2 (d x l)

l	d		3	4	4.5	5	6
16							
20							
25							
30							
35							
40				•			
45							
50				•	•	•	
60				•		•	
70						•	
80						•	•
90							
100							
110							
120							•

	Picture currently unavailable	<b>BUGLEBATTEN SCREWS</b>
Grade A2 / 304		Article No. 7100 (d x l)

l	d	3.5	3.9	4.2	4.8	5.5	6.3
20							
25							
30							
40							
50							•
75							•
100							•

Product details and availability subject to change without notice.

DANDENONG  
CAMPBELLFIELD  
KILSYTH

TEL (03) **9794 5570**  
TEL (03) **9357 9611**  
TEL (03) **9761 4125**

FAX (03) 9791 3212  
FAX (03) 9357 9488  
FAX (03) 9761 4286

***"We have the right product at the right price, when you need it, on-time, everytime"***

section  
**five**

# **NUT PRODUCTS**

# Hexagon Nuts

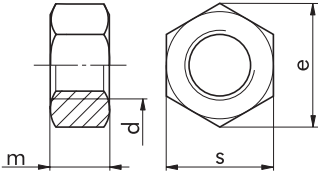
<b>DIN 934</b> (ISO 4032)  Grade A2 / 304		<b>HEXAGON NUTS</b>  ArticleNo. 9342 (d)
--	---	---

d	e	m	s
M2.5	5.45	2	5
M3	6.01	2.4	5.5
M4	7.66	3.2	7
M5	8.79	4	8
M6	11.05	5	10
M8	14.38	6.5	13
M10	18.90	8	17
M12	21.10	10	19
M14	24.49	11	22
M16	26.75	13	24
M18	29.56	15	27
M20	32.95	16	30
M24	39.55	19	36
M27	45.20	22	41
M30	50.85	24	46

Product details and availability subject to change without notice.

DANDENONG  
 CAMPBELLFIELD  
 KILSYTH

TEL (03) **9794 5570**  
 TEL (03) **9357 9611**  
 TEL (03) **9761 4125**

FAX (03) 9791 3212  
 FAX (03) 9357 9488  
 FAX (03) 9761 4286

***“We have the right product at the right price, when you need it, on-time, everytime”***

# Hexagon Nuts

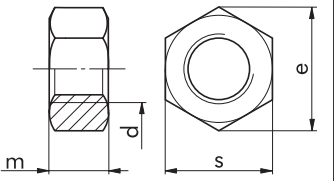
<b>DIN 934</b> (ISO 4032)  Grade A4 / 316		<b>HEXAGON NUTS</b>  ArticleNo. 9344 (d)
--	---	---

d	e	m	s
M3	6.01	2.4	5.5
M4	7.66	3.2	7
M5	8.79	4	8
M6	11.05	5	10
M8	14.38	6.5	13
M10	18.9	8	17
M12	21.1	10	19
M14	24.49	11	22
M16	26.75	13	24
M18	29.56	15	27
M20	32.95	16	30
M24	39.55	19	36
M27	45.2	22	41
M30	50.85	24	46
M33	n/a	n/a	n/a

Grade A2 / 304	Picture currently unavailable	<b>HEXAGON FLANGE NUTS</b>  ArticleNo. 93452 (d)
----------------	-------------------------------	---

Diameter
M5
M6
M8

Product details and availability subject to change without notice.

DANDENONG  
 CAMPBELLFIELD  
 KILSYTH

TEL (03) **9794 5570**  
 TEL (03) **9357 9611**  
 TEL (03) **9761 4125**

FAX (03) 9791 3212  
 FAX (03) 9357 9488  
 FAX (03) 9761 4286

**“We have the right product at the right price, when you need it, on-time, everytime”**

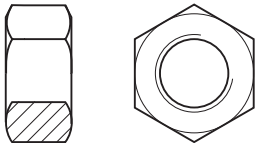

## Hexagon Nuts

ANSI B18.2.2		<p>HEXAGON NUTS</p> <p>Article No. 7322 (d)</p>
Grade A2 / 304		

Diameter
3/16"
1/4"
5/16"
3/8"
1/2"
5/8"

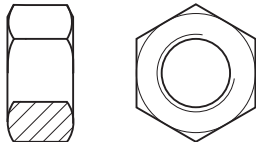
ANSI B18.2.2		<p>HEXAGON NUTS</p> <p>Article No. 7326 (t.d)</p>
Grade A4 / 316		

For Thread Diameter $\varnothing$
3/16"
1/4"
5/16"
3/8"
1/2"
5/8"

Product details and availability subject to change without notice.

DANDENONG  
CAMPBELLFIELD  
KILSYTH

TEL (03) **9794 5570**  
TEL (03) **9357 9611**  
TEL (03) **9761 4125**

FAX (03) 9791 3212  
FAX (03) 9357 9488  
FAX (03) 9761 4286

## Hexagon Thin Nuts

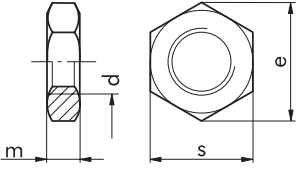
<b>DIN 439</b> (ISO 4035/4036)  Grade A2 / 304		<b>HEXAGON THIN NUTS</b>  ArticleNo. 4392 (d)
---	---	--

d	e	s	m
M3	6.01	5.5	1.8
M4	7.66	7	2.2
M5	8.79	8	2.7
M6	11.05	10	3.2
M8	14.38	13	3.7
M10	18.9	17	4.7
M12	21.1	19	5.7
M14	24.49	22	6.42
M16	26.75	24	7.42

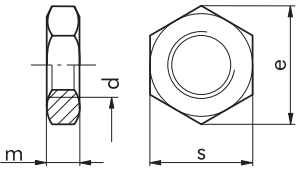
<b>DIN 439</b> (ISO 4035/4036)  Grade A4 / 316		<b>HEXAGON THIN NUTS</b>  ArticleNo. 4394 (d)
---	---	--

d	e	s	m
M6	11.05	10	3.2
M8	14.38	13	4
M10	18.9	17	5
M12	21.1	19	6
M16	26.75	22	8

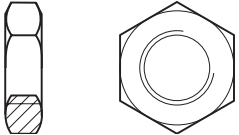
<b>ANSI B18.2.2</b>  Grade A4 / 316		<b>HEXAGON THIN NUTS</b>  ArticleNo. 7334 (t.d)
---	---	--

For Thread Diameter $\phi$
1/4"
5/16"
3/8"
1/2"

Product details and availability subject to change without notice.

DANDENONG  
 CAMPBELLFIELD  
 KILSYTH

TEL (03) **9794 5570**  
 TEL (03) **9357 9611**  
 TEL (03) **9761 4125**

FAX (03) 9791 3212  
 FAX (03) 9357 9488  
 FAX (03) 9761 4286

**"We have the right product at the right price, when you need it, on-time, everytime"**

# Nylon Insert Nuts

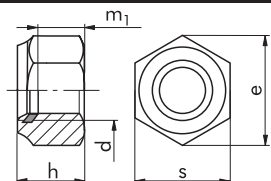
<b>DIN 985</b>  Grade A2 / 304		<b>NYLON INSERT NUTS</b>  ArticleNo. 9852 (d)
--------------------------------------	---	--

d	e	s	h	m1
M3	6.01	5.5	4	1.65
M4	7.66	7	5	2.2
M5	8.79	8	5	2.75
M6	11.05	10	6	3.3
M8	14.38	13	8	4.4
M10	18.90	17	10	5.5
M12	21.10	19	12	6.6
M14	24.49	22	14	7.7
M16	26.75	24	16	8.8
M20	32.95	30	20	11

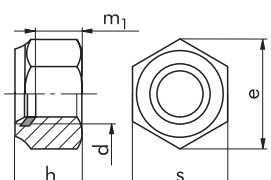
<b>DIN 985</b>  Grade A4 / 316		<b>NYLON INSERT NUTS</b>  ArticleNo. 9854 (d)
--------------------------------------	---	--

d	e	s	m1	h
M4	7.66	7	2.2	5
M5	8.79	8	2.75	5
M6	11.05	10	3.3	6
M8	14.38	13	4.4	8
M10	18.9	17	5.5	10
M12	21.1	19	6.6	12
M16	26.75	24	8.8	16
M20	32.95	30	11	20

Product details and availability subject to change without notice.

DANDENONG  
 CAMPBELLFIELD  
 KILSYTH

TEL (03) **9794 5570**  
 TEL (03) **9357 9611**  
 TEL (03) **9761 4125**

FAX (03) 9791 3212  
 FAX (03) 9357 9488  
 FAX (03) 9761 4286

**“We have the right product at the right price, when you need it, on-time, everytime”**

## Nylon Insert Nuts

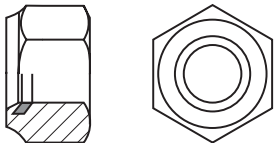
Grade A2 / 304		<p style="text-align: center;">NYLON INSERT NUTS</p> <p style="text-align: center;">Article No. 7325 (d)</p>
----------------	---	--

Diameter
3/16"
1/4"
5/16"
3/8"
1/2"
5/8"

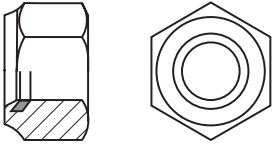
Grade A4 / 316		<p style="text-align: center;">NYLON INSERT NUTS</p> <p style="text-align: center;">Article No. 7397 (t.d)</p>
----------------	---	--

For Thread Diameter ø
3/16"
1/4"
5/16"
3/8"
1/2"
5/8"

Product details and availability subject to change without notice.

DANDENONG  
CAMPBELLFIELD  
KILSYTH

TEL (03) **9794 5570**  
TEL (03) **9357 9611**  
TEL (03) **9761 4125**

FAX (03) 9791 3212  
FAX (03) 9357 9488  
FAX (03) 9761 4286

***"We have the right product at the right price, when you need it, on-time, everytime"***

# Dome Nuts

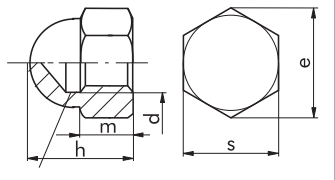
DIN 1587				DOME NUTS ArticleNo. 1587 2 (d)	
Grade A2 / 304					
d		e	s	h	m
M3		6.01	5.5	7	2.4
M4		7.66	7	8	3.2
M5		8.79	8	10	4
M6		11.05	10	12	5
M8		14.38	13	15	6.5
M10		18.9	17	18	8
M12		21.1	19	22	10
M16		n/a	n/a	n/a	n/a
M18		n/a	n/a	n/a	n/a
M20		n/a	n/a	n/a	n/a

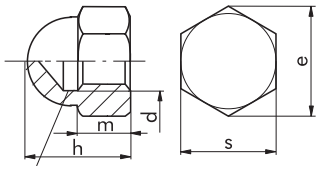
DIN 1587				DOME NUTS ArticleNo. 1587 4 (d)	
Grade A4 / 316					
d		e	s	h	m
M4		7.66	7	8	3.2
M5		8.79	8	10	4
M6		11.05	10	12	5
M8		14.38	13	15	6.5
M10		18.9	17	18	8
M12		21.1	19	22	10
M16		n/a	n/a	n/a	n/a
M18		n/a	n/a	n/a	n/a
M20		n/a	n/a	n/a	n/a

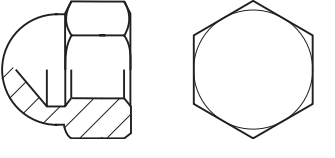
AUSTRALIAN STANDARD				DOME NUTS ArticleNo. 7324 (d)	
Grade A2 / 304					
Diameter					
3/16"					
1/4"					
5/16"					
3/8"					
1/2"					

Product details and availability subject to change without notice.

DANDENONG  
 CAMPBELLFIELD  
 KILSYTH

TEL (03) **9794 5570**  
 TEL (03) **9357 9611**  
 TEL (03) **9761 4125**

FAX (03) 9791 3212  
 FAX (03) 9357 9488  
 FAX (03) 9761 4286

**"We have the right product at the right price, when you need it, on-time, everytime"**

# Wing Nuts

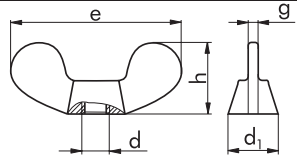
<b>DIN 315</b>		<b>WING NUTS</b>
Grade A2 / 304		Article No. 3152 (d)

d	d <sub>1</sub>	e	h	g
M4	6	18	8.5	1.9
M5	8	24	11	2.3
M6	10	30	15	2.3
M8	13	36	18	2.8
M10	17	48	23	4.4
M12	20	62	31	4.9

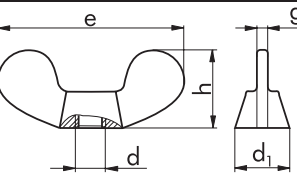
Grade A2 / 304		<b>WING NUTS</b>
		Article No. 7342 (d)

Diameter
3/16"
1/4"
5/16"
3/8"
1/2"

Product details and availability subject to change without notice.

DANDENONG  
CAMPBELLFIELD  
KILSYTH

TEL (03) **9794 5570**  
TEL (03) **9357 9611**  
TEL (03) **9761 4125**

FAX (03) 9791 3212  
FAX (03) 9357 9488  
FAX (03) 9761 4286

***"We have the right product at the right price, when you need it, on-time, everytime"***

# Wing Nuts

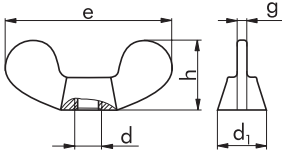
<b>DIN 315</b>		<b>WING NUTS</b>
Grade A4 / 316		Article No. 3154 (d)

d	d <sub>1</sub>	e	h	g
M5	8	24	11	2.3
M6	10	30	15	2.3
M8	13	36	18	2.8
M10	17	48	23	4.4

Grade A4 / 316		<b>WING NUTS</b>
		Article No. 7344 (d)

Diameter
3/16"
1/4"
5/16"
3/8"
1/2"

Product details and availability subject to change without notice.

DANDENONG  
CAMPBELLFIELD  
KILSYTH

TEL (03) **9794 5570**  
TEL (03) **9357 9611**  
TEL (03) **9761 4125**

FAX (03) 9791 3212  
FAX (03) 9357 9488  
FAX (03) 9761 4286

***"We have the right product at the right price, when you need it, on-time, everytime"***

section  
**six**

# WASHER PRODUCTS

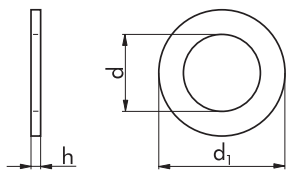

# Flat Washers

<b>DIN 125</b> (ISO 7089/7090)  Grade A2 / 304		<b>FLAT WASHERS</b>  Article No. 1252 (t.d)
---	--	--

For Thread Diameter $\varnothing$	d	d <sub>1</sub>	h
M2.5	2.7	6	0.5
M3	3.2	7	0.5
M4	4.3	9	0.8
M5	5.3	10	1
M6	6.4	12	1.6
M8	8.4	16	1.6
M10	10.5	20	2
M12	13	24	2.5
M14	15	28	2.5
M16	17	30	3
M18	19	34	3
M20	21	37	3
M22	23	39	3
M24	25	44	4
M27	28	50	4
M30	n/a	n/a	n/a

Product details and availability subject to change without notice.

DANDENONG  
 CAMPBELLFIELD  
 KILSYTH

TEL (03) **9794 5570**  
 TEL (03) **9357 9611**  
 TEL (03) **9761 4125**

FAX (03) 9791 3212  
 FAX (03) 9357 9488  
 FAX (03) 9761 4286

***“We have the right product at the right price, when you need it, on-time, everytime”***

# Flat Washers

## DIN 125

ISO (7089/7090)

Form A to 16mm (ISO 7089)

Form B above 18mm (ISO 7090)

Grade A4 / 316

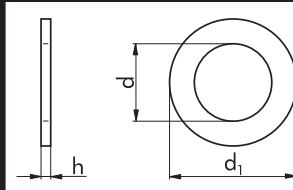

FLAT WASHERS

Article No.  
1254 (t.d)

For Thread Diameter $\phi$	d	d <sub>1</sub>	h
M3	3.2	7	0.5
M4	4.3	9	0.8
M5	5.3	10	1
M6	6.4	12	1.6
M8	8.4	16	1.6
M10	10.5	20	2
M12	13	24	2.5
M16	17	30	3
M20	21	37	3
M24	25	44	4
M27	28	50	4
M30	31	56	4
M36	n/a	n/a	n/a

Product details and availability subject to change without notice.

DANDENONG  
CAMPBELLFIELD  
KILSYTH

TEL (03) **9794 5570**  
TEL (03) **9357 9611**  
TEL (03) **9761 4125**

FAX (03) 9791 3212  
FAX (03) 9357 9488  
FAX (03) 9761 4286

***"We have the right product at the right price, when you need it, on-time, everytime"***

# Flat Washers

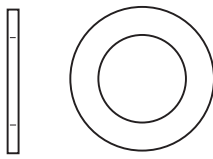
ANSI B18.22.1		<b>FLAT WASHERS</b>  ArticleNo. 7409 (t.d x o/d)
Grade A2 / 304		

For Thread	o/d	5/16	3/8	1/2	5/8	3/4	1	1 1/4	1 1/2
Diameter ø									
1/8"		•							
5/32"			•						
3/16"				•		•			
1/4"				•	•	•	•		
5/16"					•	•	•		
3/8"						•	•		•
1/2"							•	•	
5/8"									•

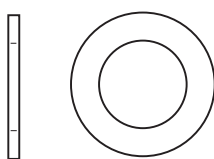
ANSI B18.22.1		<b>FLAT WASHERS</b>  ArticleNo. 7412 (t.d x o/d)
Grade A4 / 316		

For Thread	Diameter ø	o/d	7/16	5/8	3/4	7/8	1	1 1/4	1 1/2	2
3/16"			•							
1/4"				•	•		•			
5/16"					•		•			
3/8"					•	•	•		•	
1/2"								•		•
5/8"									•	

Product details and availability subject to change without notice.

DANDENONG  
 CAMPBELLFIELD  
 KILSYTH

TEL (03) **9794 5570**  
 TEL (03) **9357 9611**  
 TEL (03) **9761 4125**

FAX (03) 9791 3212  
 FAX (03) 9357 9488  
 FAX (03) 9761 4286

**"We have the right product at the right price, when you need it, on-time, everytime"**

# Penny Washers

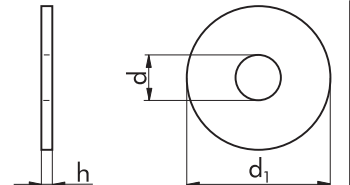
<b>DIN 9021</b> (ISO 7093)  Grade A2 / 304		<b>PENNY WASHERS</b>  ArticleNo. 9021 2 (d)
---	---	--

For Thread Diameter $\varnothing$	d	d <sub>1</sub>	h
M3	3.2	9	0.8
M4	4.3	12	1
M5	5.3	15	1.2
M6	6.4	18	1.6
M8	8.4	24	2
M10	10.5	30	2.5
M12	13.0	37	3
M14	15.0	45	3
M16	17.0	50	3
M18	20.0	56	4
M20	21.0	60	4

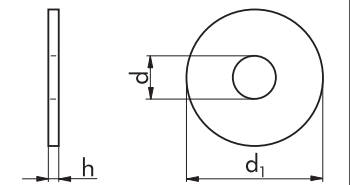
<b>DIN 9021</b> (ISO 7093)  Grade A4 / 316		<b>PENNY WASHERS</b>  ArticleNo. 9021 4 (d)
---	---	--

For Thread Diameter $\varnothing$	d	d <sub>1</sub>	h
M4	4.3	12	1
M5	5.3	15	1.2
M6	6.4	18	1.6
M8	8.4	24	2
M10	10.5	30	2.5
M12	13	37	3
M16	17	50	3
M20	22	60	4

Product details and availability subject to change without notice.

DANDENONG  
 CAMPBELLFIELD  
 KILSYTH

TEL (03) **9794 5570**  
 TEL (03) **9357 9611**  
 TEL (03) **9761 4125**

FAX (03) 9791 3212  
 FAX (03) 9357 9488  
 FAX (03) 9761 4286

***“We have the right product at the right price, when you need it, on-time, everytime”***

# Cup washer

Grade A2 / 304	Picture currently unavailable	<p style="text-align: center;">CUPWASHER</p> <p style="text-align: center;">Article No. 1458</p>
----------------	-------------------------------	--

For Thread Diameter $\varnothing$	
4G	2.9mm
6G	3.5mm
8G	4.2mm
10G	4.8mm
12G	5.5mm
14G	6.3mm

Product details and availability subject to change without notice.

DANDENONG  
 CAMPBELLFIELD  
 KILSYTH

TEL (03) **9794 5570**  
 TEL (03) **9357 9611**  
 TEL (03) **9761 4125**

FAX (03) 9791 3212  
 FAX (03) 9357 9488  
 FAX (03) 9761 4286

***“We have the right product at the right price, when you need it, on-time, everytime”***

# Spring Washers

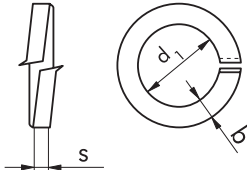
<b>DIN 127</b> Form B  Grade A2 / 304		SPRING WASHERS  ArticleNo. 1272 (d)
--	---	--

d	d <sub>1</sub>	b	s
M2.5	2.6	1	0.6
M3	3.1	1.3	0.8
M4	4.1	1.5	0.9
M5	5.1	1.8	1.2
M6	6.1	2.5	1.6
M8	8.1	3	2
M10	10.2	3.5	2.2
M12	12.2	4	2.5
M14	14.2	4.5	3
M16	16.2	5	3.5
M20	20.2	6	4
M24	24.5	7	5

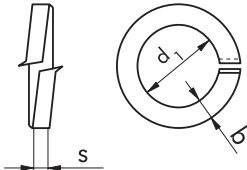
<b>DIN 127</b> Form B  Grade A4 / 316		SPRING WASHERS  ArticleNo. 1274 (d)
--	---	--

d	d <sub>1</sub>	b	s
M3	3.1	1.3	0.8
M4	4.1	1.5	0.9
M5	5.1	1.8	1.2
M6	6.1	2.5	1.6
M8	8.1	3	2
M10	10.2	3.5	2.2
M12	12.2	4	2.5
M14	14.2	4.5	3
M16	16.2	5	3.5
M20	20.2	6	4
M24	24.5	7	5

Product details and availability subject to change without notice.

DANDENONG  
 CAMPBELLFIELD  
 KILSYTH

TEL (03) **9794 5570**  
 TEL (03) **9357 9611**  
 TEL (03) **9761 4125**

FAX (03) 9791 3212  
 FAX (03) 9357 9488  
 FAX (03) 9761 4286

**“We have the right product at the right price, when you need it, on-time, everytime”**

# Spring Washers

<b>ANSI B18.21.2</b>  <b>Grade A4 / 316</b>		<b>SPRING WASHERS</b>  <b>Article No. 7445 (t.d)</b>
---	---	--

For Thread Diameter $\varnothing$
3/16"
1/4"
5/16"
3/8"
1/2"
5/8"

<b>ANSI B18.21.2</b>  <b>Grade A2 / 304</b>		<b>SPRING WASHERS</b>  <b>Article No. 7447 (t.d)</b>
---	---	--

For Thread Diameter $\varnothing$
3/16"
1/4"
5/16"
3/8"
1/2"
5/8"

Product details and availability subject to change without notice.

DANDENONG  
CAMPBELLFIELD  
KILSYTH

TEL (03) **9794 5570**  
TEL (03) **9357 9611**  
TEL (03) **9761 4125**

FAX (03) 9791 3212  
FAX (03) 9357 9488  
FAX (03) 9761 4286

***"We have the right product at the right price, when you need it, on-time, everytime"***

## External/Internal Toothed Washers

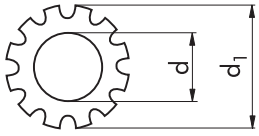
<b>DIN 6797</b> Form A  Grade A2 / 304		<b>EXTERNAL TOOTHED WASHERS</b>  Article No. 6797 22 (t.d)
---	---	---

For Thread Diameter $\varnothing$	d	d1	
M3	3.2	6	
M4	4.3	8	
M5	5.3	10	
M6	6.4	11	
M8	8.4	15	
M10	10.5	18	
M12	13	20.5	

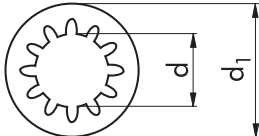
<b>DIN 6797</b> Form J  Grade A2 / 304		<b>INTERNAL TOOTHED WASHERS</b>  Article No. 6797 12 (t.d)
---	---	---

For Thread Diameter $\varnothing$	d	d1	
M3	3.2	6	
M4	4.3	8	
M5	5.3	10	
M6	6.4	11	
M8	8.4	15	
M10	10.5	18	

Product details and availability subject to change without notice.

DANDENONG  
 CAMPBELLFIELD  
 KILSYTH

TEL (03) **9794 5570**  
 TEL (03) **9357 9611**  
 TEL (03) **9761 4125**

FAX (03) 9791 3212  
 FAX (03) 9357 9488  
 FAX (03) 9761 4286

***"We have the right product at the right price, when you need it, on-time, everytime"***



Product details and availability subject to change without notice.

DANDENONG  
CAMPBELLFIELD  
KILSYTH

TEL (03) **9794 5570**  
TEL (03) **9357 9611**  
TEL (03) **9761 4125**

FAX (03) 9791 3212  
FAX (03) 9357 9488  
FAX (03) 9761 4286

section  
**seven**

**MISCELLANEOUS**

# External Circlips

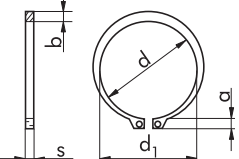
<b>DIN 471</b>		<b>EXTERNAL CIRCLIPS</b>
Grade A2 / 304		Article No. 4712 (d)

d	a	b	d1	s
4	2.2	0.9	3.7	0.4
5	2.5	1.1	4.7	0.6
6	2.7	1.3	5.6	0.7
7	3.1	1.4	6.5	0.8
8	3.2	1.5	7.4	0.8
10	3.3	1.8	9.3	1
12	3.3	1.8	11	1
13	3.4	2	11.9	1
14	3.5	2.1	12.9	1
15	3.6	2.2	13.8	1
16	3.7	2.2	14.7	1
17	3.8	2.3	15.7	1
18	3.9	2.4	16.5	1.2
20	4	2.6	18.5	1.2
22	4.2	2.8	20.5	1.2
24	4.4	3	22.2	1.2
25	4.4	3	23.2	1.2
28	4.7	3.2	25.9	1.5
30	5	3.5	27.9	1.5
32	n/a	n/a	n/a	n/a
35	5.6	3.9	32.2	1.5
40	6	4.4	36.5	1.75
45	6.7	4.7	41.5	1.75
50	6.9	5.1	45.8	2
55	7.2	5.4	50.8	2
60	7.4	5.8	55.8	2

Product details and availability subject to change without notice.

DANDENONG  
CAMPBELLFIELD  
KILSYTH

TEL (03) **9794 5570**  
TEL (03) **9357 9611**  
TEL (03) **9761 4125**

FAX (03) 9791 3212  
FAX (03) 9357 9488  
FAX (03) 9761 4286

**“We have the right product at the right price, when you need it, on-time, everytime”**

# Internal Circlips

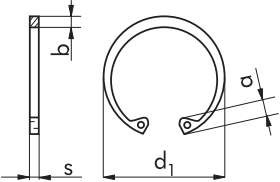
<b>DIN 472</b>		<b>INTERNAL CIRCLIPS</b>  Article No. <b>4722 (d)</b>
----------------	---	--

d	a	b	d1	s
12	3.4	1.7	13	1
16	3.8	2	17.3	1
18	4.1	2.2	19.5	1
19	4.1	2.2	20.5	1
20	4.1	2.3	21.5	1
22	4.2	2.5	23.5	1
26	4.7	2.8	27.9	1.2
28	4.8	2.9	30.1	1.2
30	4.8	3	32.1	1.2
32	5.4	3.2	34.4	1.5
35	5.4	3.4	37.8	1.5
40	5.8	3.9	43.5	1.75
42	5.9	4.1	45.5	1.75
47	6.4	4.4	50.5	1.75
50	6.5	4.6	54.2	2
55	6.8	5	59.2	2
62	7.3	5.5	66.2	2

Product details and availability subject to change without notice.

DANDENONG  
 CAMPBELLFIELD  
 KILSYTH

TEL (03) **9794 5570**  
 TEL (03) **9357 9611**  
 TEL (03) **9761 4125**

FAX (03) 9791 3212  
 FAX (03) 9357 9488  
 FAX (03) 9761 4286

***“We have the right product at the right price, when you need it, on-time, everytime”***

# Split Pins

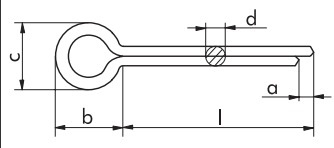
<b>DIN 94</b> (ISO 1234)  Grade A2 / 304		<b>SPLIT PINS</b>  ArticleNo. 0942 (d x l)
---	--	---

<b>a</b>	n/a	n/a	2.5	3.2	4	4	4	
<b>b</b>	n/a	n/a	5	6.4	8	10	10	
<b>c</b>	n/a	n/a	4	5.1	6.5	8	8	

l	d	1.6	2	2.5	3.2	4	5	5.5
10mm		•		•				
12mm		•	•	•				
16mm		•	•	•				
20mm		•	•	•	•			
25mm		•	•	•	•	•	•	
32mm		•	•	•	•	•		
36mm					•			
40mm			•	•	•	•	•	
45mm								
50mm			•	•	•	•	•	
63mm							•	

# Threaded Rod

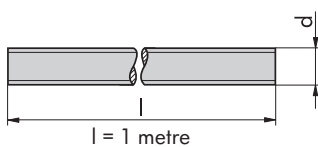
Grade A2 / 304		<b>THREADED ROD</b>  ArticleNo. 7761 (d)
----------------	---	---

d
1/4"
5/16"
3/8"
1/2"
3/4"

Product details and availability subject to change without notice.

DANDENONG  
 CAMPBELLFIELD  
 KILSYTH

TEL (03) **9794 5570**  
 TEL (03) **9357 9611**  
 TEL (03) **9761 4125**

FAX (03) 9791 3212  
 FAX (03) 9357 9488  
 FAX (03) 9761 4286

**"We have the right product at the right price, when you need it, on-time, everytime"**

# Threaded Rod

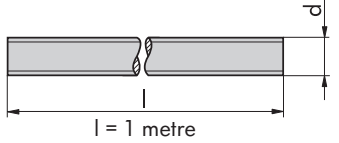
<b>DIN 976-1</b>		THREADED ROD
Grade A2 / 304		ArticleNo. 9761 2 (d)

d
M3
M4
M5
M6
M8
M10
M12
M14
M16
M20
M24
M27
M30

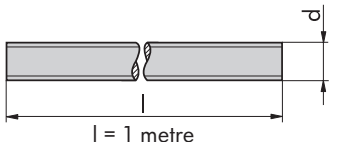
<b>DIN 976-1</b>		THREADED ROD
Grade A4 / 316		ArticleNo. 9761 4 (d)

d
M4
M5
M6
M8
M10
M12
M14
M16
M20
M24
M30

Product details and availability subject to change without notice.

DANDENONG  
CAMPBELLFIELD  
KILSYTH

TEL (03) **9794 5570**  
TEL (03) **9357 9611**  
TEL (03) **9761 4125**

FAX (03) 9791 3212  
FAX (03) 9357 9488  
FAX (03) 9761 4286

***“We have the right product at the right price, when you need it, on-time, everytime”***

# Grub Screws

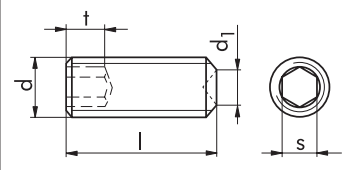
<b>DIN 916</b>		<b>GRUB SCREWS</b>
Grade A2 / 304		Article No. 9162 (d x l)

d <sub>1</sub>	1.4	2	2.5	3	5	6	8
t	1.2	1.5	2	2	3	6	8
s	1.5	2	2.5	3	4	5	6

l	d	M3	M4	M5	M6	M8	M10	M12
3		•						
4		•	•					
5		•	•	•				
6		•	•	•	•			
8			•	•	•			
10			•	•	•	•	•	
12			•	•	•	•	•	
16			•	•	•	•	•	•
20				•		•	•	
25				•	•	•	•	•

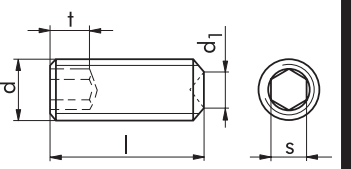
<b>DIN 916</b> (ISO 4029)		<b>GRUB SCREWS</b>
Grade A4 / 316		Article No. 9164 (d x l)

d <sub>1</sub>	1.4	2	2.5	3	5	6
t	1.2	1.5	2	2	3	6
s	1.5	2	2.5	3	4	5

l	d	M3	M4	M5	M6	M8	M10
3							
4							
5							
6				•	•		
8			•	•	•		
10			•	•	•	•	
12			•	•	•	•	
16			•		•	•	
20					•	•	

Product details and availability subject to change without notice.

DANDENONG  
CAMPBELLFIELD  
KILSYTH

TEL (03) **9794 5570**  
TEL (03) **9357 9611**  
TEL (03) **9761 4125**

FAX (03) 9791 3212  
FAX (03) 9357 9488  
FAX (03) 9761 4286

**“We have the right product at the right price, when you need it, on-time, everytime”**

## Rivets - Domed Head Seal

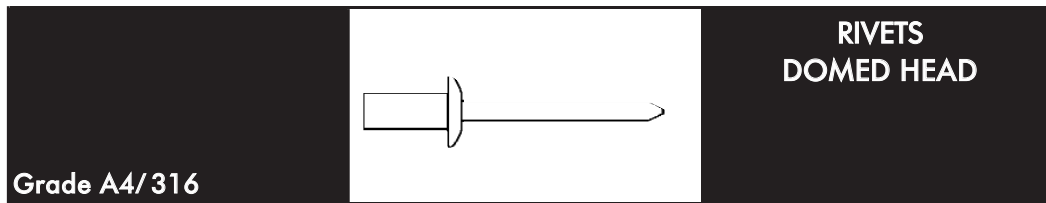

l	d	2.5	3.2	4	5		
6.4				•			
7							
7.5							
10							
10.4					•		
12.7							
13							
14.5							

## Rivet Nuts

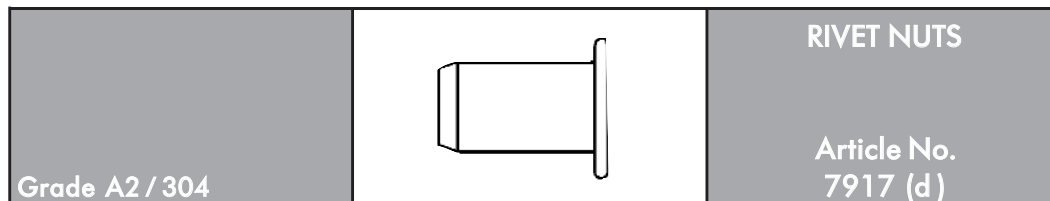

d
3mm
4mm
5mm
6mm
8mm
10mm
12mm

Product details and availability subject to change without notice.

DANDENONG  
CAMPBELLFIELD  
KILSYTH

TEL (03) **9794 5570**  
TEL (03) **9357 9611**  
TEL (03) **9761 4125**

FAX (03) 9791 3212  
FAX (03) 9357 9488  
FAX (03) 9761 4286

***“We have the right product at the right price, when you need it, on-time, everytime”***

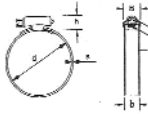

# Hose Clamps

Grade A2 / 304		<p style="text-align: center;">HOSE CLAMPS</p> <p style="text-align: center;">Article No. 7538 (b.w x c.r)</p>
----------------	---	--

Band Thickness (s)			0.6	0.8		
Housing Width (B)			11.5	15.5		
Housing Height (h)			9.5	12		

Clamping Range d	Band Width	9mm	13mm		
8-12		•			
12-20		•			
16-27		•	•		
20-32		•	•		
25-40		•	•		
35-50		•	•		
40-60		•	•		
50-70		•	•		
60-80		•	•		
70-90		•	•		
80-100		•	•		
90-110		•	•		
100-120			•		
130-150			•		

Product details and availability subject to change without notice.

DANDENONG  
CAMPBELLFIELD  
KILSYTH

TEL (03) **9794 5570**  
TEL (03) **9357 9611**  
TEL (03) **9761 4125**

FAX (03) 9791 3212  
FAX (03) 9357 9488  
FAX (03) 9761 4286

**“We have the right product at the right price, when you need it, on-time, everytime”**

Additional Product Ranges also available:



**Stainless Steel Fittings**



**Winches**



**Balustrading**



**Rope/Webbing**



**Wire Rope**



**Nuts & Bolts**



**Alloy**



**Chain**



**Lifting**



**Hardware**



**Rigging**



**Safety**

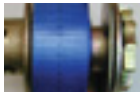

**Transport**



**Measuring**



IMPORT • EXPORT • AGENTS • PROMOTIONS

Interstate callers **1800 067 687**

**DANDENONG**

Tel (03) 9794 5570  
Fax (03) 9791 3212  
Unit 1/28 Johnston Court  
Dandenong Vic 3175

**CAMPBELLFIELD**

Tel (03) 9357 9611  
Fax (03) 9357 9488  
Unit 6, 1880 Hume Highway  
Campbellfield Vic 3061

**KILSYTH**

Tel (03) 9761 4125  
Fax (03) 9761 4286  
Unit 1, 120 Canterbury Road  
Kilsyth Vic 3137

Visit our website: [www.keblestrading.com.au](http://www.keblestrading.com.au)



***We have the right product, at the right price, when you need it, on-time, every time***