

## SEMİTRANS® M IGBT Modules

**SKM 150 GB 123 D**  
**SKM 150 GAL 123 D <sup>6)</sup>**  
**SKM 150 GAR 123 D <sup>6)</sup>**

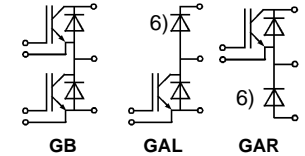

**SEMİTRANS 3**



### Features

- MOS input (voltage controlled)
- N channel, Homogeneous Si
- Low inductance case
- Very low tail current with low temperature dependence
- High short circuit capability, self limiting to  $6 \cdot I_{cnom}$
- Latch-up free
- Fast & soft inverse CAL diodes<sup>8)</sup>
- Isolated copper baseplate using DCB Direct Copper Bonding Technology
- Large clearance (12 mm) and creepage distances (20 mm).

### Typical Applications: → B 6 - 63

- Switching (not for linear use)

1)  $T_{case} = 25^\circ\text{C}$ , unless otherwise specified

2)  $I_F = -I_C$ ,  $V_R = 600\text{ V}$ ,  $-di/dt = 1000\text{ A}/\mu\text{s}$ ,  $V_{GE} = 0\text{ V}$

3) Use  $V_{GEOFF} = -5 \dots -15\text{ V}$

5) See fig. 2 + 3;  $R_{Goff} = 6,8\ \Omega$

6) The free-wheeling diodes of the GAL and GAR types have the data of the inverse diodes of SKM 200 GB 123 D

7)  $V_{isol} = 4000\text{ V}_{rms}$  on request

8) CAL = Controlled Axial Lifetime Technology.

**Cases and mech. data → B6 - 64**  
**SEMİTRANS 3**

Absolute Maximum Ratings		Values		Units
Symbol	Conditions <sup>1)</sup>			
$V_{CES}$		1200		V
$V_{CGR}$	$R_{GE} = 20\text{ k}\Omega$	1200		V
$I_C$	$T_{case} = 25/80^\circ\text{C}$	150 / 100		A
$I_{CM}$	$T_{case} = 25/80^\circ\text{C}$ ; $t_p = 1\text{ ms}$	300 / 200		A
$V_{GES}$		$\pm 20$		V
$P_{tot}$	per IGBT, $T_{case} = 25^\circ\text{C}$	800		W
$T_j$ , ( $T_{stg}$ )		- 40 ... +150 (125)		$^\circ\text{C}$
$V_{isol}$	AC, 1 min.	2 500 <sup>7)</sup>		V
humidity	DIN 40 040	Class F		
climate	DIN IEC 68 T.1	55/150/56		
Inverse Diode				
$I_F = -I_C$	$T_{case} = 25/80^\circ\text{C}$	150 / 100	FWD <sup>6)</sup> 200 / 135	A
$I_{FM} = -I_{CM}$	$T_{case} = 25/80^\circ\text{C}$ ; $t_p = 1\text{ ms}$	300 / 200	300 / 200	A
$I_{FSM}$	$t_p = 10\text{ ms}$ ; $\sin$ ; $T_j = 150^\circ\text{C}$	1100	1450	A
$I^2t$	$t_p = 10\text{ ms}$ ; $T_j = 150^\circ\text{C}$	6000	10500	$\text{A}^2\text{s}$

Characteristics					Units
Symbol	Conditions <sup>1)</sup>	min.	typ.	max.	
$V_{(BR)CES}$	$V_{GE} = 0$ , $I_C = 4\text{ mA}$	$\geq V_{CES}$	-	-	V
$V_{GE(th)}$	$V_{GE} = V_{CES}$ , $I_C = 4\text{ mA}$	4,5	5,5	6,5	V
$I_{CES}$	$V_{GE} = 0$ } $T_j = 25^\circ\text{C}$	-	0,2	2	mA
	$V_{CE} = V_{CES}$ } $T_j = 125^\circ\text{C}$	-	9	-	mA
$I_{GES}$	$V_{GE} = 20\text{ V}$ , $V_{CE} = 0$	-	-	1	$\mu\text{A}$
$V_{CESat}$	$I_C = 100\text{ A}$ } $V_{GE} = 15\text{ V}$ ;	-	2,5(3,1)	3(3,7)	V
$V_{CESat}$	$I_C = 150\text{ A}$ } $T_j = 25\text{ (125) }^\circ\text{C}$ }	-	3(3,8)	-	V
$g_{fs}$	$V_{CE} = 20\text{ V}$ , $I_C = 100\text{ A}$	54	-	-	S
$C_{CHC}$	per IGBT	-	-	700	pF
$C_{ies}$	$V_{GE} = 0$	-	6,5	8,5	nF
$C_{oes}$	$V_{CE} = 25\text{ V}$	-	1000	1500	pF
$C_{res}$	$f = 1\text{ MHz}$	-	500	600	pF
$L_{CE}$		-	-	20	nH
$t_{d(on)}$	$V_{CC} = 600\text{ V}$	-	160	320	ns
$t_r$	$V_{GE} = +15\text{ V}$ ; $-15\text{ V}^{3)}$	-	80	160	ns
$t_{d(off)}$	$I_C = 100\text{ A}$ , ind. load	-	400	520	ns
$t_f$	$R_{Gon} = R_{Goff} = 6,8\ \Omega$	-	70	100	ns
$E_{on}^{5)}$	$T_j = 125^\circ\text{C}$	-	13	-	mWs
$E_{off}^{5)}$		-	11	-	mWs
Inverse Diode <sup>8)</sup>					
$V_F = V_{EC}$	$I_F = 100\text{ A}$ } $V_{GE} = 0\text{ V}$ ;	-	2,0(1,8)	2,5	V
$V_F = V_{EC}$	$I_F = 150\text{ A}$ } $T_j = 25\text{ (125) }^\circ\text{C}$ }	-	2,25(2,1)	-	V
$V_{TO}$	$T_j = 125^\circ\text{C}$	-	-	1,2	V
$r_T$	$T_j = 125^\circ\text{C}$	-	8	11	m $\Omega$
$I_{RRM}$	$I_F = 100\text{ A}$ ; $T_j = 25\text{ (125) }^\circ\text{C}^{2)}$	-	35(50)	-	A
$Q_{rr}$	$I_F = 100\text{ A}$ ; $T_j = 25\text{ (125) }^\circ\text{C}^{2)}$	-	5(14)	-	$\mu\text{C}$
FWD of types "GAL", "GAR" <sup>8)</sup>					
$V_F = V_{EC}$	$I_F = 100\text{ A}$ } $V_{GE} = 0\text{ V}$ ;	-	1,85(1,6)	2,2	V
$V_F = V_{EC}$	$I_F = 150\text{ A}$ } $T_j = 25\text{ (125) }^\circ\text{C}$ }	-	2,0(1,8)	-	V
$V_{TO}$	$T_j = 125^\circ\text{C}$	-	-	1,2	V
$r_T$	$T_j = 125^\circ\text{C}$	-	5	7	m $\Omega$
$I_{RRM}$	$I_F = 100\text{ A}$ ; $T_j = 25\text{ (125) }^\circ\text{C}^{2)}$	-	40(65)	-	A
$Q_{rr}$	$I_F = 100\text{ A}$ ; $T_j = 25\text{ (125) }^\circ\text{C}^{2)}$	-	5(15)	-	$\mu\text{C}$
Thermal Characteristics					
$R_{thjc}$	per IGBT	-	-	0,16	$^\circ\text{C}/\text{W}$
$R_{thjc}$	per diode / FWD "GAL"; "GAR"	-	-	0,30/0,25	$^\circ\text{C}/\text{W}$
$R_{thch}$	per module	-	-	0,038	$^\circ\text{C}/\text{W}$

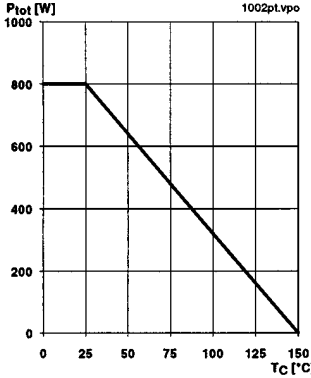

Fig. 1 Rated power dissipation  $P_{tot} = f(T_c)$

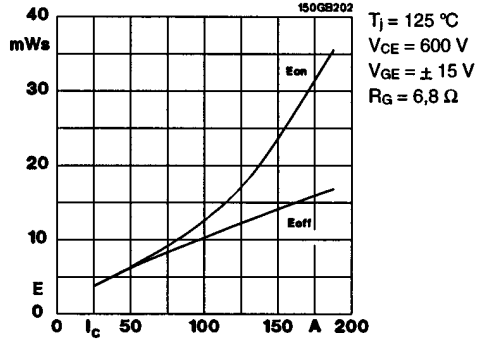

Fig. 2 Turn-on /-off energy =  $f(I_c)$

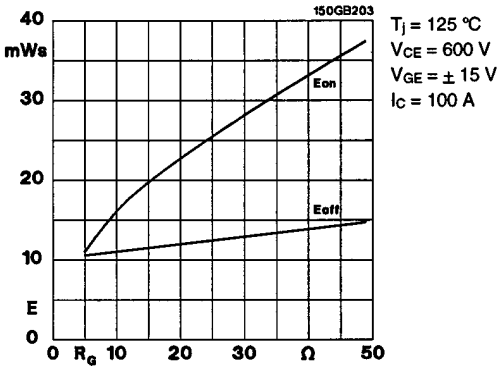

Fig. 3 Turn-on /-off energy =  $f(R_G)$

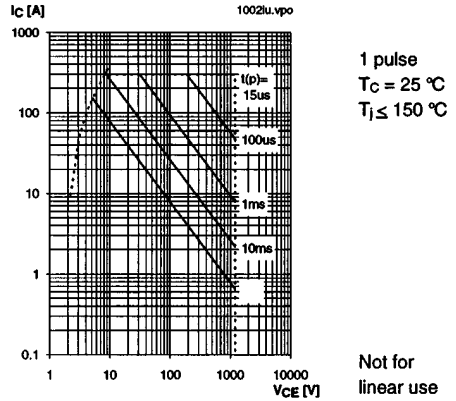

Fig. 4 Maximum safe operating area (SOA)  $I_c = f(V_{CE})$

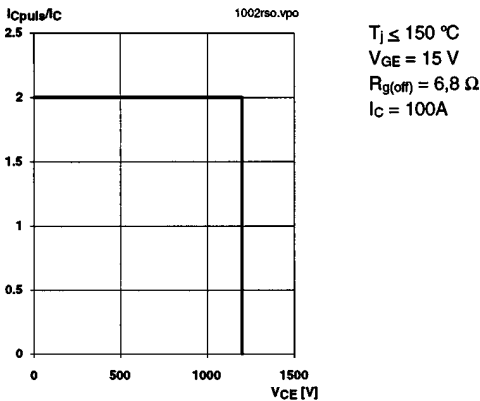

Fig. 5 Turn-off safe operating area (RBSOA)

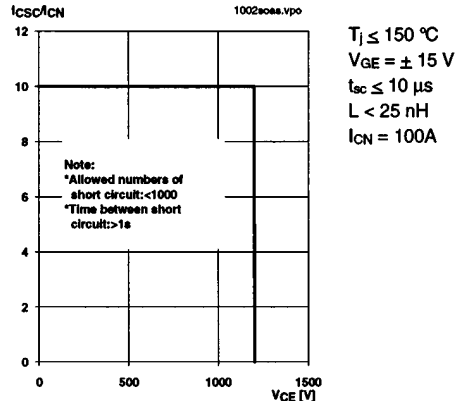

Fig. 6 Safe operating area at short circuit  $I_c = f(V_{CE})$

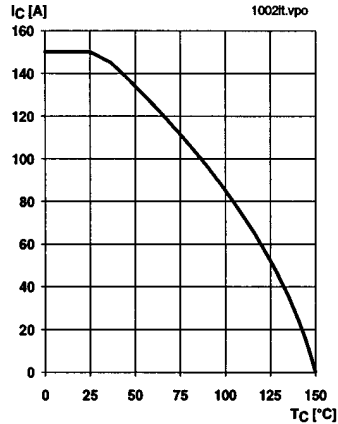

Fig. 8 Rated current vs. temperature  $I_C = f(T_C)$

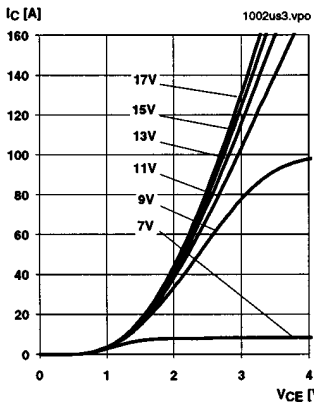

Fig. 9 Typ. output characteristic,  $t_p = 80 \mu s$ ;  $25^\circ C$

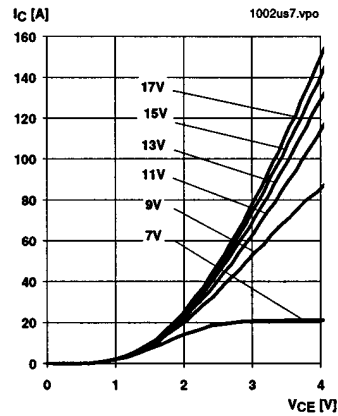

Fig. 10 Typ. output characteristic,  $t_p = 80 \mu s$ ;  $125^\circ C$

$$P_{cond(t)} = V_{CEsat(t)} \cdot I_C(t)$$

$$V_{CEsat(t)} = V_{CE(TO)(Tj)} + r_{CE(Tj)} \cdot I_C(t)$$

$$V_{CE(TO)(Tj)} \leq 1,5 + 0,002 (T_j - 25) [V]$$

$$r_{CE(Tj)} = 0,010 + 0,00004 (T_j - 25) [\Omega]$$

$$\text{valid for } V_{GE} = +15 \frac{+2}{-1} [V]; I_C > 0,3 I_{Cnom}$$

Fig. 11 Typ. saturation characteristic (IGBT)  
Calculation elements and equations

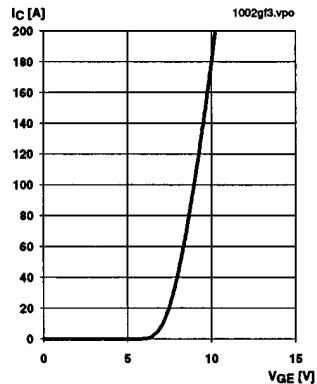

Fig. 12 Typ. transfer characteristic,  $t_p = 80 \mu s$ ;  $V_{CE} = 20 V$

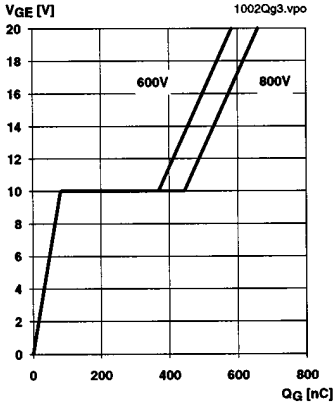

Fig. 13 Typ. gate charge characteristic

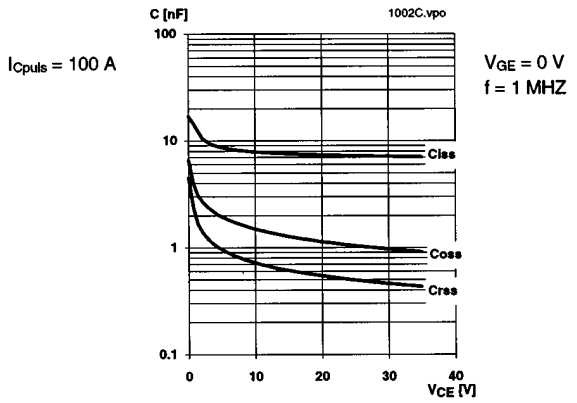

Fig. 14 Typ. capacitances vs.  $V_{CE}$

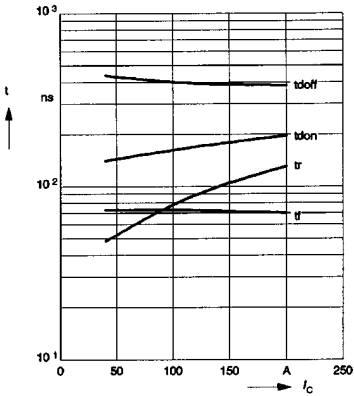

Fig. 15 Typ. switching times vs.  $I_C$

$T_j = 125\text{ }^\circ\text{C}$   
 $V_{CE} = 600\text{ V}$   
 $V_{GE} = \pm 15\text{ V}$   
 $R_{gon} = 6,8\ \Omega$   
 $R_{goff} = 6,8\ \Omega$   
 induct. load

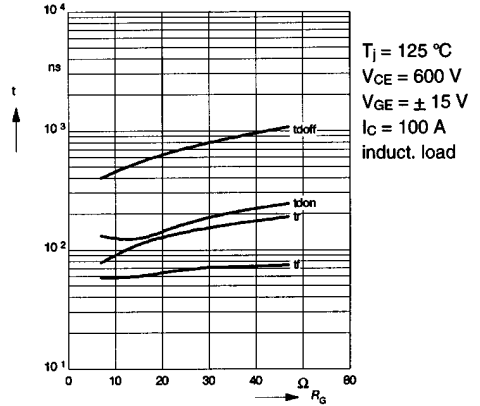

Fig. 16 Typ. switching times vs. gate resistor  $R_g$

$T_j = 125\text{ }^\circ\text{C}$   
 $V_{CE} = 600\text{ V}$   
 $V_{GE} = \pm 15\text{ V}$   
 $I_C = 100\text{ A}$   
 induct. load

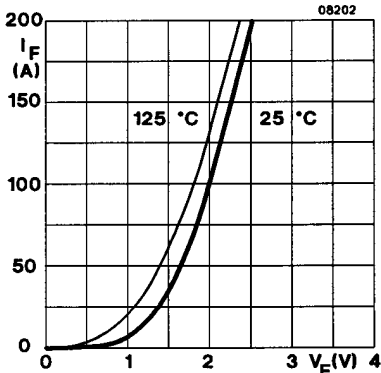

Fig. 17 Typ. CAL diode forward characteristic

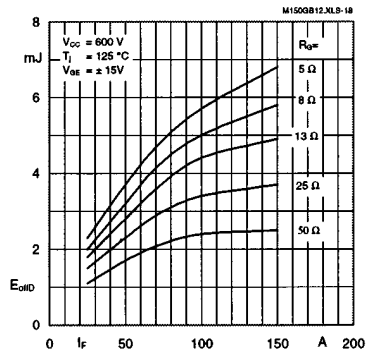

Fig. 18 Diode turn-off energy dissipation per pulse

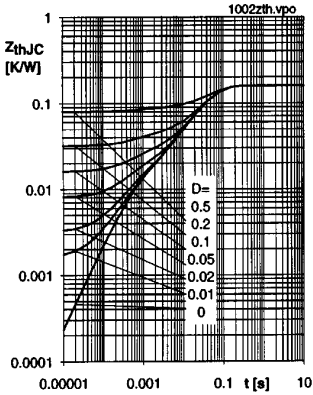

Fig. 19 Transient thermal impedance of IGBT  
 $Z_{thJC} = f(t_p)$ ;  $D = t_p / t_c = t_p \cdot f$

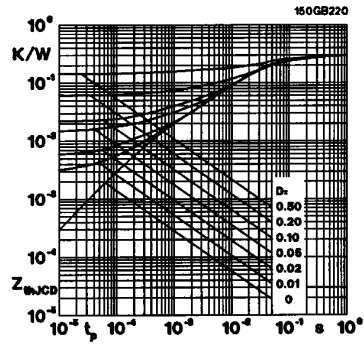

Fig. 20 Transient thermal impedance of inverse CAL diodes  
 $Z_{thJC} = f(t_p)$ ;  $D = t_p / t_c = t_p \cdot f$

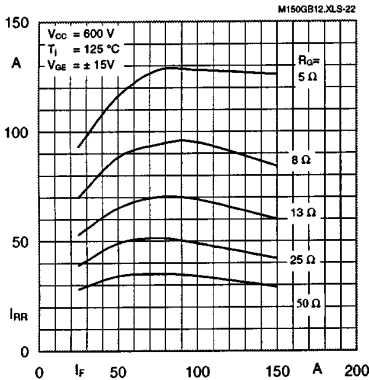

Fig. 22 Typ. CAL diode reverse recovery current  $I_{RR} = f(I_F, R_G)$

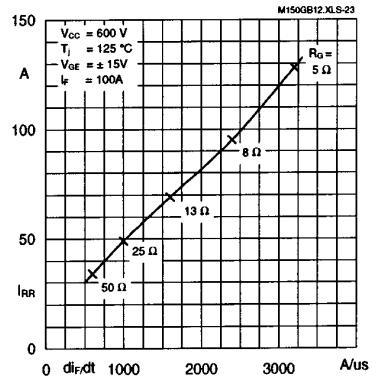

Fig. 23 Typ. CAL diode reverse recovery current  $I_{RR} = f(di_F/dt)$

## Typical Applications include

- Switched mode power supplies
- DC servo and robot drives
- Inverters
- DC choppers (versions GAL and GAR)
- AC motor speed control
- Inductive heating
- UPS Uninterruptable power supplies
- General power switching applications
- Electronic (also portable) welders
- Pulse frequencies also above 15 kHz

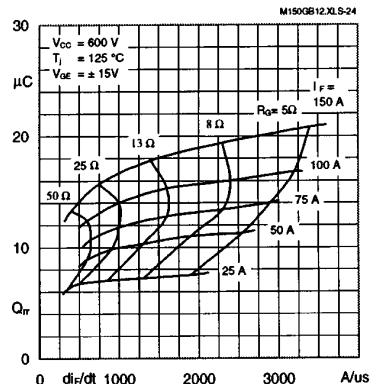

Fig. 24 Typ. CAL diode recovered charge  $Q_{rr} = f(di/dt)$

**SEMISTRANS 3**

Case D 56  
UL Recognized  
File no. E 63 532

CASED56

SKM 150 GB 123 D  
SKM 150 GB 173 D

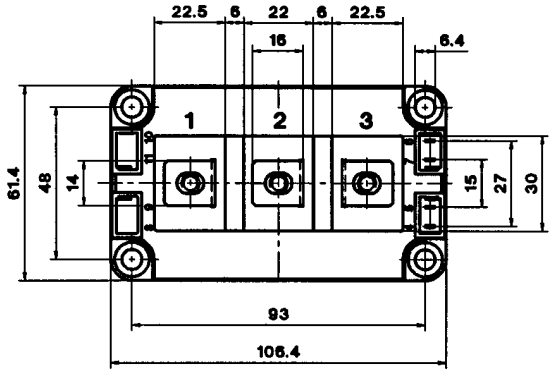
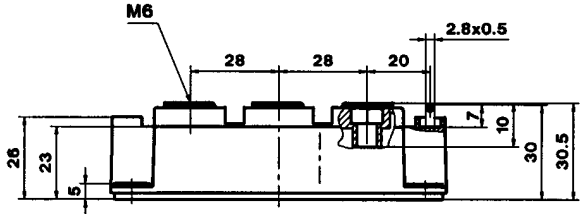
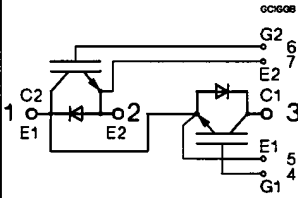

Dimensions in mm

**SKM 150 GAL 123 D**

Case D 57 (→ D 56)

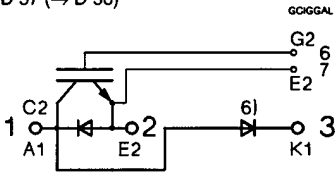

**SKM 150 GAR 123 D**

Case D 58 (→ D 56)

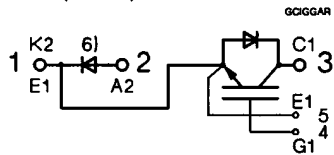

Case outline and circuit diagrams

**Mechanical Data**

Symbol	Conditions		Values			Units
			min.	typ.	max.	
M <sub>1</sub>	to heatsink, SI Units	(M6)	3	-	5	Nm
	to heatsink, US Units		27	-	44	lb.in.
M <sub>2</sub>	for terminals, SI Units	(M6)	2,5	-	5	Nm
	for terminals US Units		22	-	44	lb.in.
a			-	-	5x9,81	m/s <sup>2</sup>
w			-	-	420	g

This is an electrostatic discharge sensitive device (ESDS). Please observe the international standard IEC 747-1, Chapter IX.

Three devices are supplied in one SEMIBOX B without mounting hardware, which can be ordered separately under Ident No. 33321100 (for 10 SEMISTRANS 3). Larger packing units of 12 and 20 pieces are used if suitable

Accessories → page B 6 - 4.  
SEMIBOX → page C - 1.

<sup>6)</sup> Freewheeling diode → page B 6 - 59, remark 6.