

HOW TO BUILD THE ANTIQUE RIFLING MACHINE

The machine that is pictured in this booklet is a near exact duplicate copy of those used by many of the Early American, and frontier gunsmiths. If built right and used properly, it is quite capable of producing a very accurate rifle barrel. The many years of muzzle-loading proves this.

The following is a list of materials that you will need in order to build this type of rifling machine:

1. One construction grade 2"x8" plank twelve feet long.
2. Two 1"x2" no. 1 pine strips cut to 52 1/8" long.
3. One round log of maple, oak, or if neither of these are available, use commercial fence post. This log should be uniform, and four inches in diameter.
4. Some sort of good durable glue such as epoxy.
5. Five no. 12 round head wood screws 2 1/4" long.
6. Eight no. 8 wood screws, two flat, and six round heads, 1 1/2" long.
7. One round steel rod 1/4" in diameter and forty inches long.
8. Six wooden wedges about the size of those used to fasten hatchet heads to handles.
9. One bar of steel, 3/4" to 1" wide and 3/8" thick, 9" long.

Before you start building the rifling machine, it is a good idea to study the drawings completely before you start construction so you will have an understanding of its operation and the functions of its various parts.

The following is a list of materials that you will need in order to build this type of rifling machine:

1. One construction grade 2"x8" plank twelve feet long.
2. Two 1"x2" no. 1 pine strips cut to 52 1/8" long.
3. One round log of maple, oak, or if neither of these are available, use commercial fence post. This log should be uniform, and four inches in diameter.
4. Some sort of good durable glue such as epoxy.
5. Five no. 12 round head wood screws 2 1/4" long.
6. Eight no. 8 wood screws, two flat, and six round heads, 1 1/2" long.
7. One round steel rod 1/4" in diameter and forty inches long.
8. Six wooden wedges about the size of those used to fasten hatchet heads to handles.
9. One bar of steel, 3/4" to 1" wide and 3/8" thick, 9" long.

Before you start building the rifling machine, it is a good idea to study the drawings completely before you start construction so you will have an understanding of its operation and the functions of its various parts.

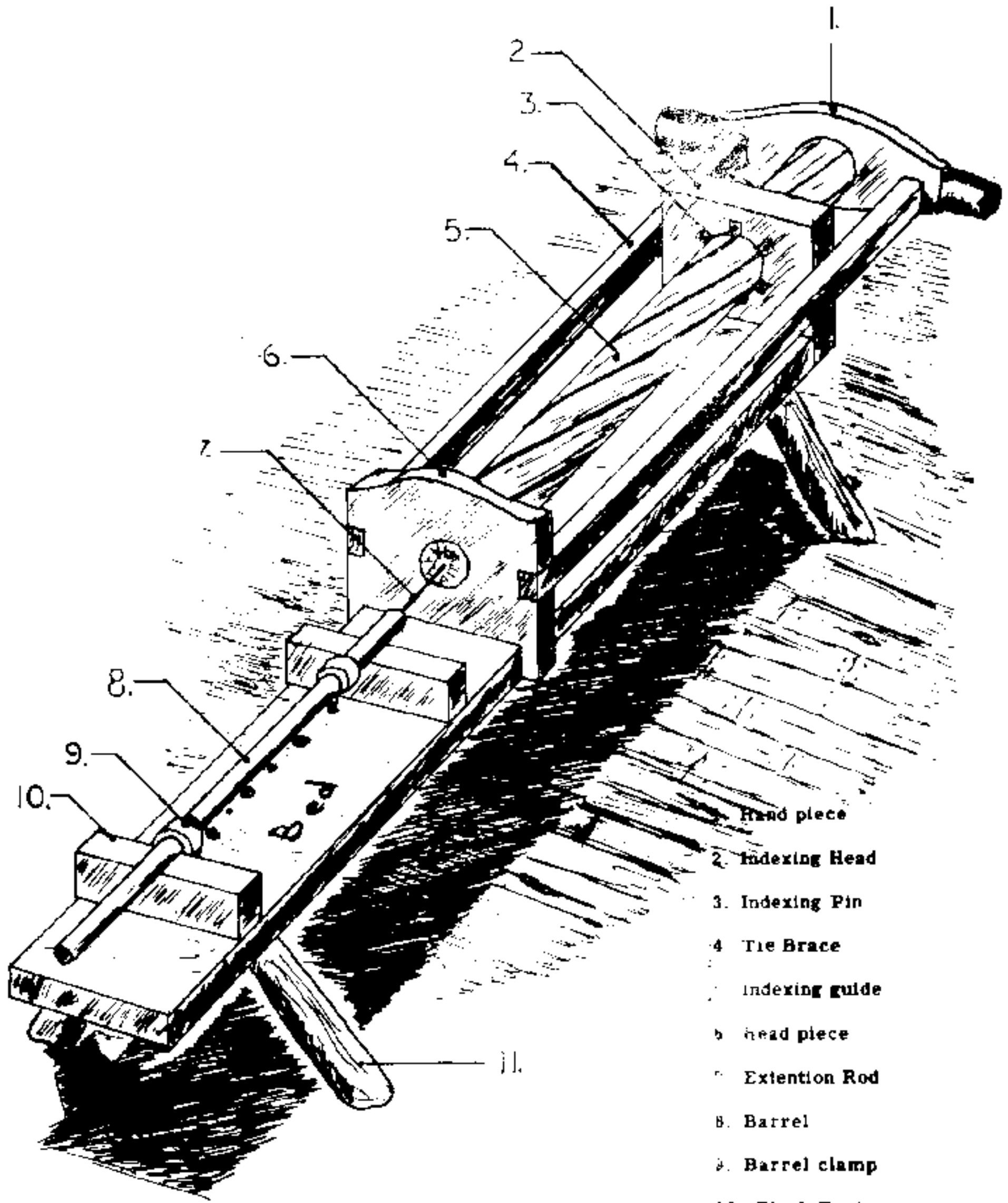

- 1. Hand piece
- 2. Indexing Head
- 3. Indexing Pin
- 4. Tie Brace
- 5. Indexing guide
- 6. head piece
- 7. Extention Rod
- 8. Barrel
- 9. Barrel clamp
- 10. Block Rests
- 11. Leg

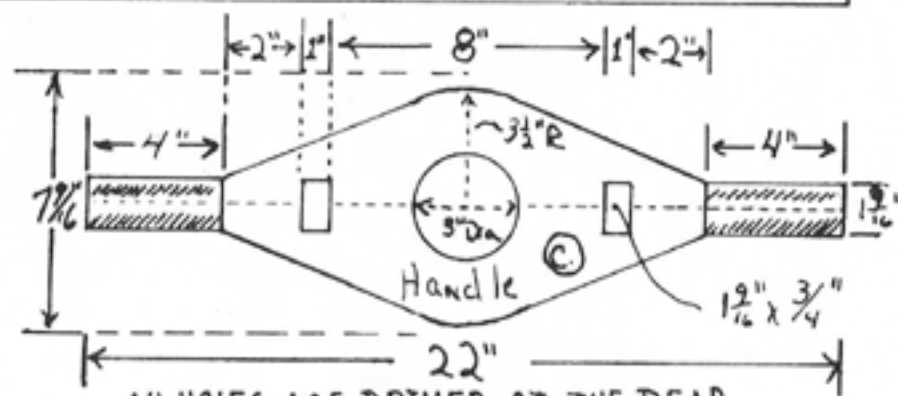
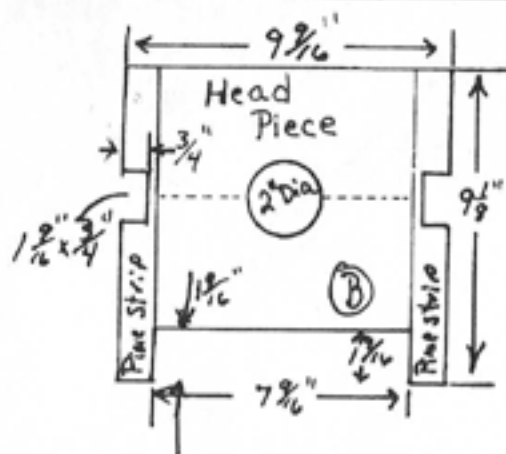
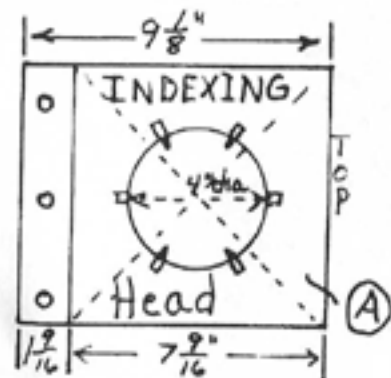
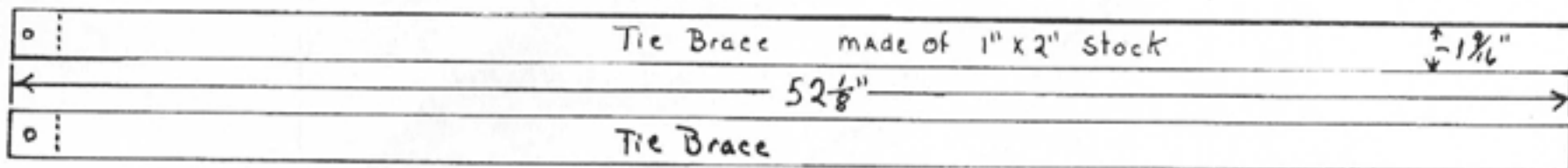
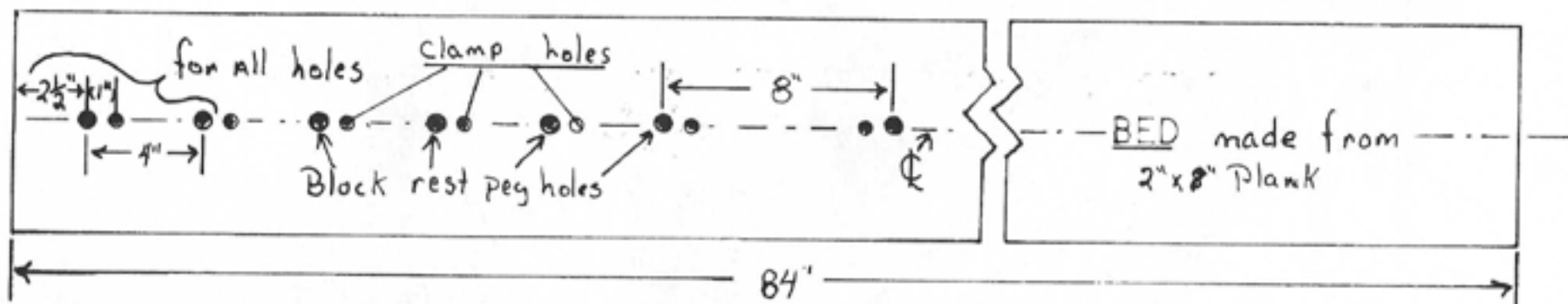
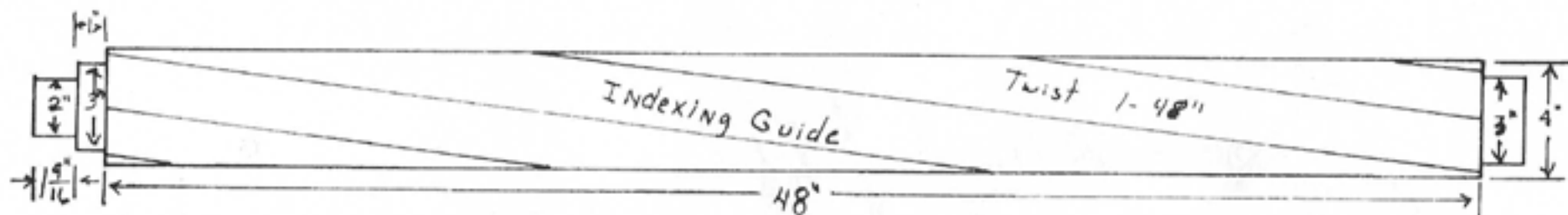

ALL HOLES ARE DRILLED AT THE DEAD OF THE STOCK FOR ITEMS A, B, C,

THE BED

Square off the end of the 2"x8" plank, and measure off 84". Cut the plank off at this point and save the extra. Next you must drill a series of holes. The holes are for the pegs of the rest blocks and the shank of the barrel clamps. It is a good idea for you to lay out all of the positions on the board before you start drilling. Start by laying out the center line of the board, then from the end start measuring and laying out the holes as shown in plate two. The position of the 2nd hole is exactly 1" from the center line of the first hole. Each peg hole [the large ones] will be four inches from the peg hole preceding it as shown in the drawing. There are six sets of holes that you will drill in this manner. The last peg hole will be

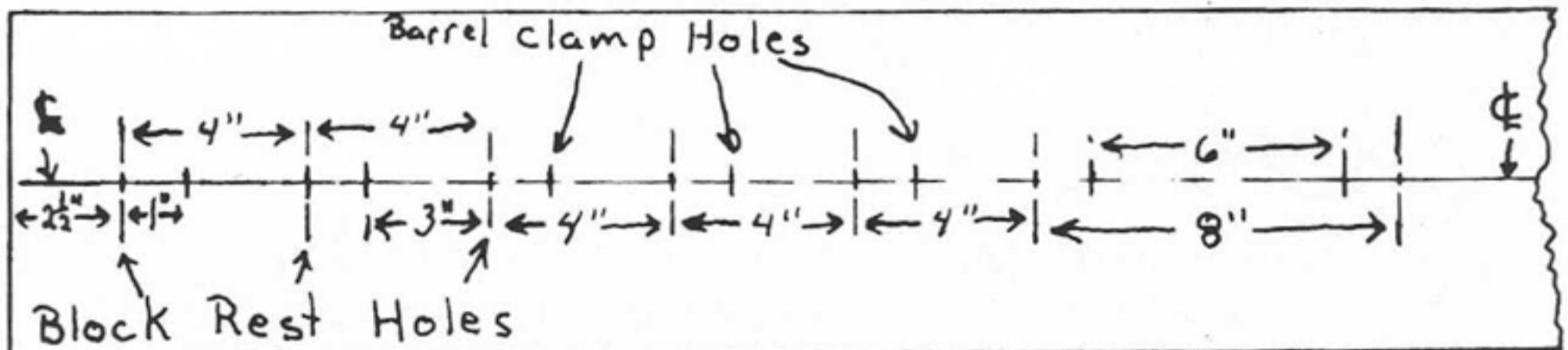

⊥ = Block Rest
(hole $1\frac{9}{16}$ ")

⊥ = Barrel CLamp
(hole $\frac{9}{16}$ ")

8" from the sixth peg hole that you drill. This last hole serves as a stationary rest block position. If you wish to, you can omit the middle peg and barrel clamp holes and just use the one that is $2\frac{1}{2}$ " from the end of the board, and measure off $30\frac{1}{2}$ " from the end and drill your last hole for the peg. The peg holes should be $1\frac{9}{16}$ " in diameter, and the barrel clamp holes should be $\frac{9}{16}$ " in diameter.

HAND PIECE

On the piece of plank that you had left, cut off a piece that is 22" long. Everything on this will be made exactly as it is shown in plate two (Handle). The outer most portions of this piece are to be rounded off. The square holes that are shown in the drawing are for the tie braces. They will have to be chiselled out completely through the board. It is also a good idea that here too, you lay out everything before you start doing any cutting. To lay out the positions, first mark out the center line and lay out the positions of all of the holes along this. About the only thing you may need to change on this piece is the diameter of the hole for the indexing guide. This will depend on the diameter of the log that you are able to secure for the indexing guide.

INDEXING HEAD

There are two pieces of the rifling machine where accuracy of measurement is of the uttermost importance. One is the indexing guide, and the other is the above, the indexing head. This piece is made from the 2"x8" plank. Cut a piece of plank that is 9 1/8" long. Draw a line that is 1 9/16" in from its length as shown in plate two. When this is done you should have a perfect square laid out on the board. To find the center of this part of the board, draw lines through the opposite corners of the square as indicated by the dashed lines in the drawing. If done properly both of these lines should intersect the center line of the board at the same point. Now with a compass or a pair of dividers, draw a circle with a diameter of 4 1/4"

INDEXING

full Scale

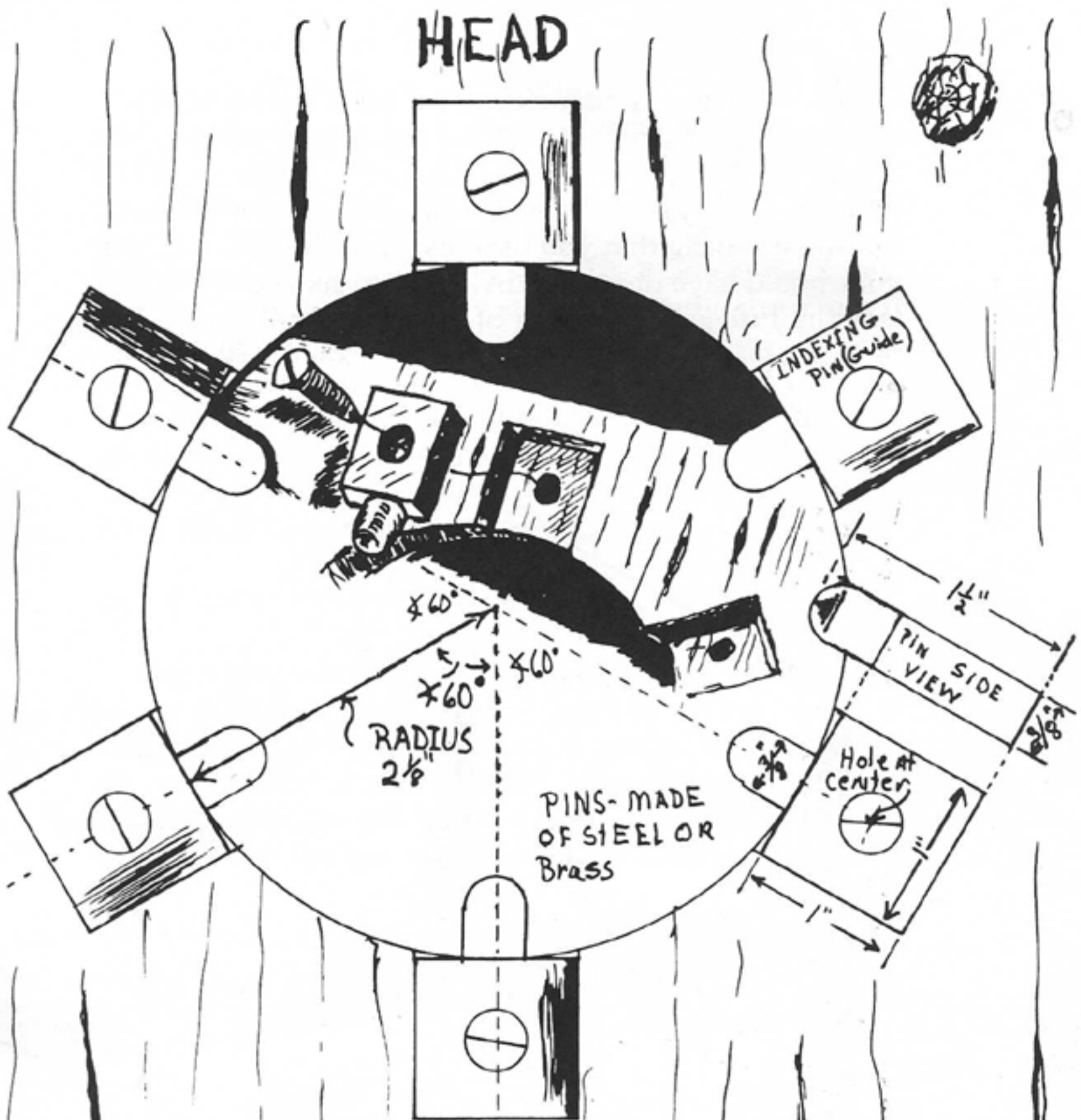

inches. With the dividers set at the same setting that you used to draw the circle, set the point of it at the point where the circle crossed the center line. If you move the dividers along the perimeter of the circle and if you have the same setting that you used as a radius for the circle, you should have the circle divided into six equal portions (see the full scale drawing of the indexing head). Each of these points of the circle will be exactly 60 degrees

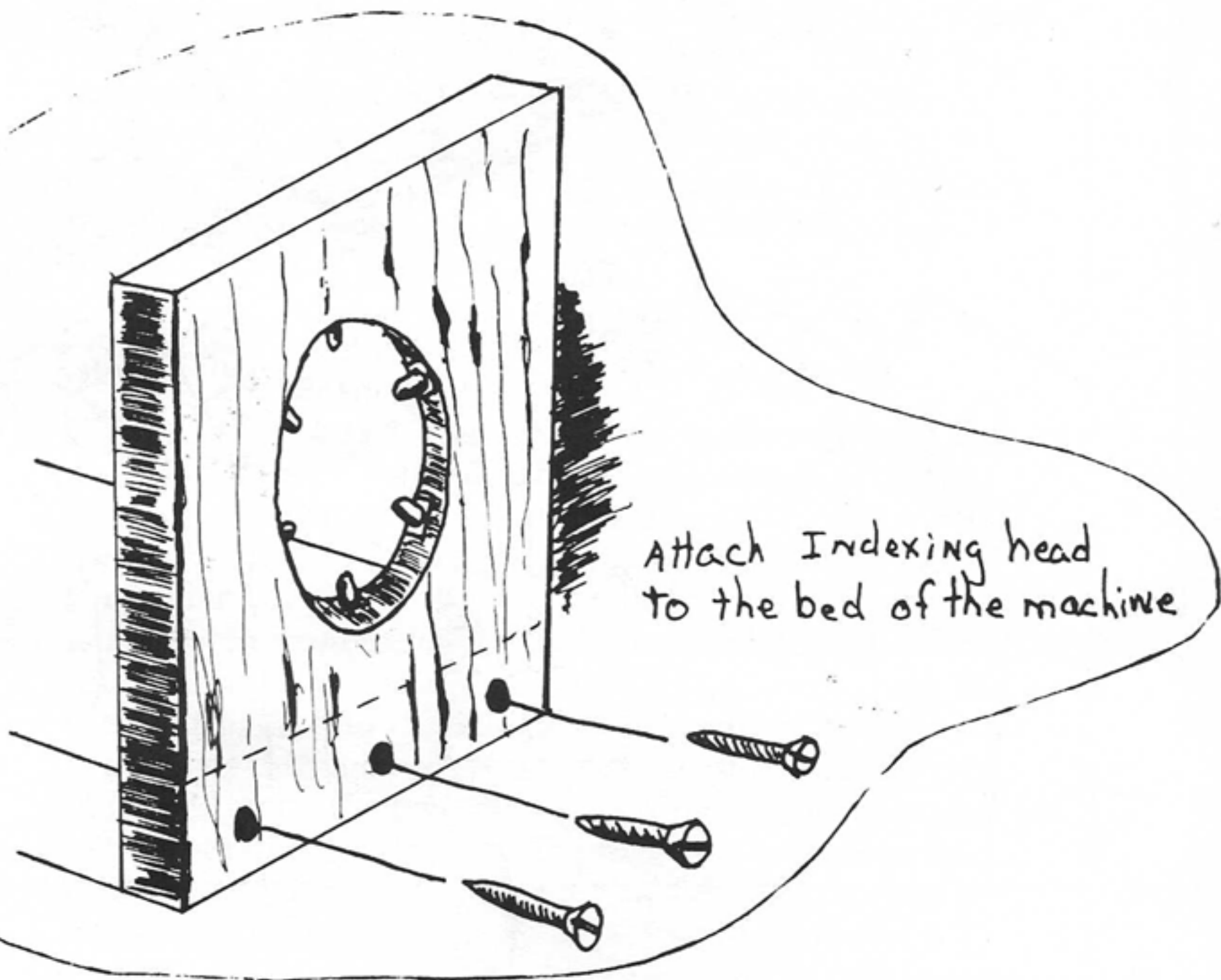

from each other. Next draw lines through each of the points through the center of the circle to the point opposite it. There will be three lines in all. Now lay out the positions of the indexing pins. With this done, you can now cut out the $4\frac{1}{4}$ " hole in the center of the board. It will be necessary to chisel out the positions of the indexing pins to a depth of $\frac{3}{8}$ " as shown in the drawing. If you did these recesses right you should almost have to push the pins into them with a little effort. You will also have to drill holes in the base of the indexing head in order to fasten it to the bed. These holes should be about the size of the screws, and positioned in close proximity with those shown in the drawing.

INDEXING PINS

These pins are made of steel, brass, or if this material is not available, some type of good hard wood such as oak, hickory, or hard maple can be used. These pins must be made in exact size and shape as shown. If you buy stock that is between $\frac{3}{4}$ " to 1" in width, $\frac{3}{8}$ " thick, and 9" long; cut the bar up into six pieces that are $1\frac{1}{2}$ " in

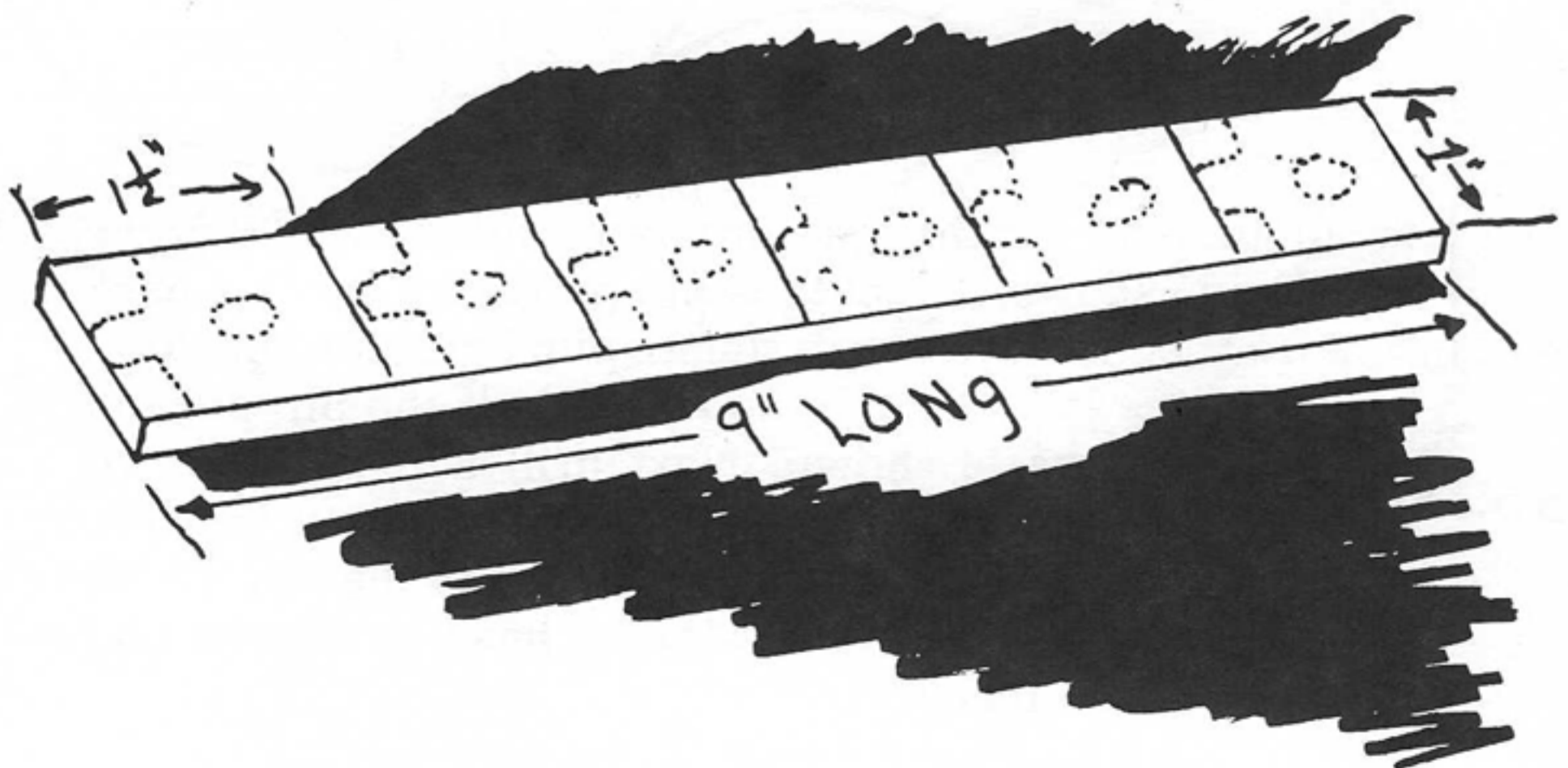

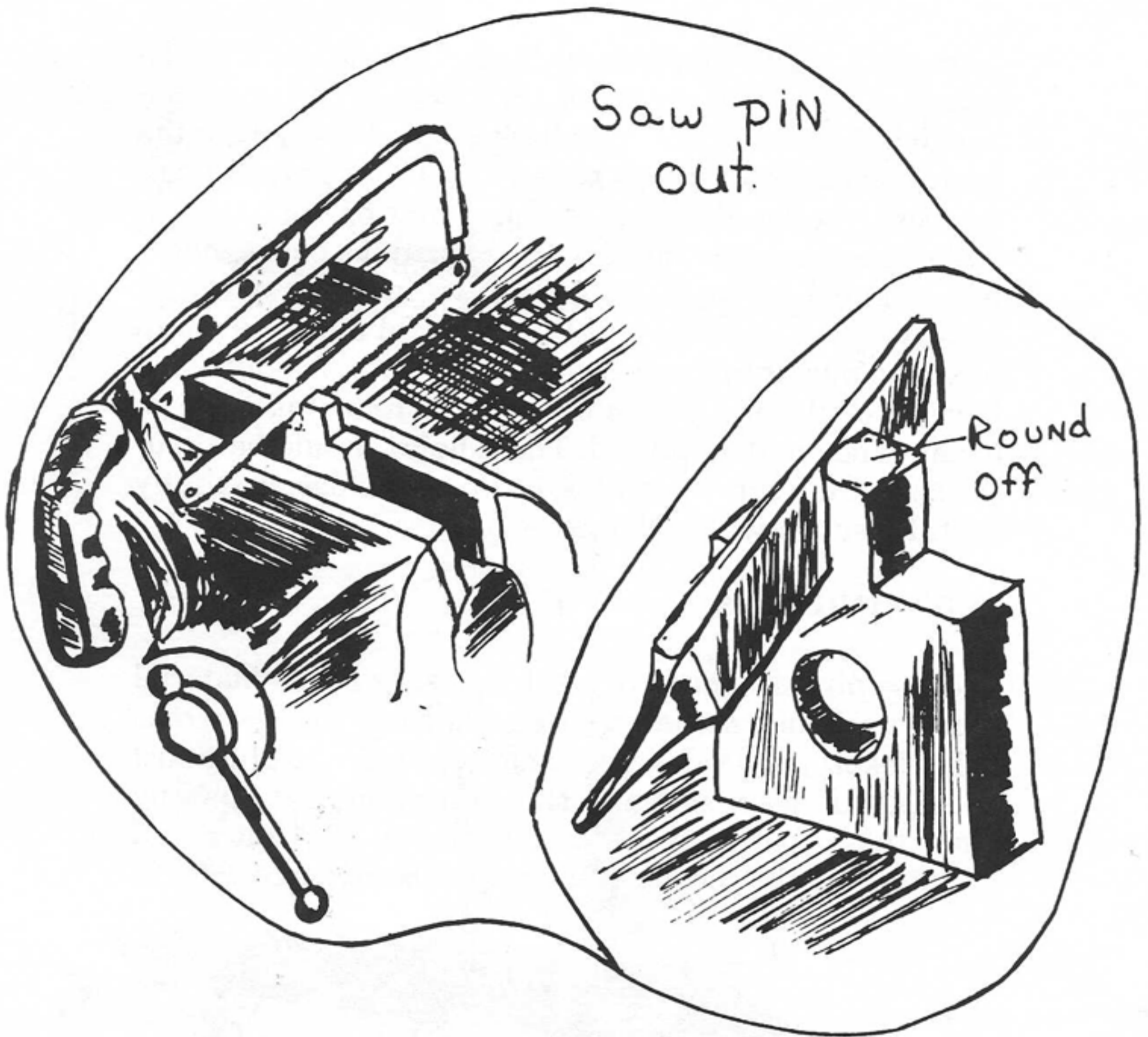

length. Now lay the measurements out the way that the drawing shows, and cut the pin portion out with a hack saw. This will have you a square pin. Place the body portion of the pin in a vice and round off the pin portion with a file as is shown. Next drill a no. 9 hole, or something larger than the diameter of the screw you use, in the dead center of the body portion of the pin. These pins are inlaid into the indexing head as shown and screwed into place.

HEAD PIECE

You should still have a pretty long piece of 2"x8" plank left. So from this, measure out another piece, this one being $7 \frac{9}{16}$ " long, and saw it. Drill a hole that is 2" in diameter at the exact center of this piece. This is for the indexing guide. From the remaining board that you have, rip out two wood strips that are one inch thick and $1 \frac{9}{16}$ " wide with a length of $9 \frac{1}{8}$ ", and glue, or nail them to the head piece as shown in the drawing, leaving room for you to cut the slots that are shown for the tie brace. These slots are centered on the horizontal center line of the piece.

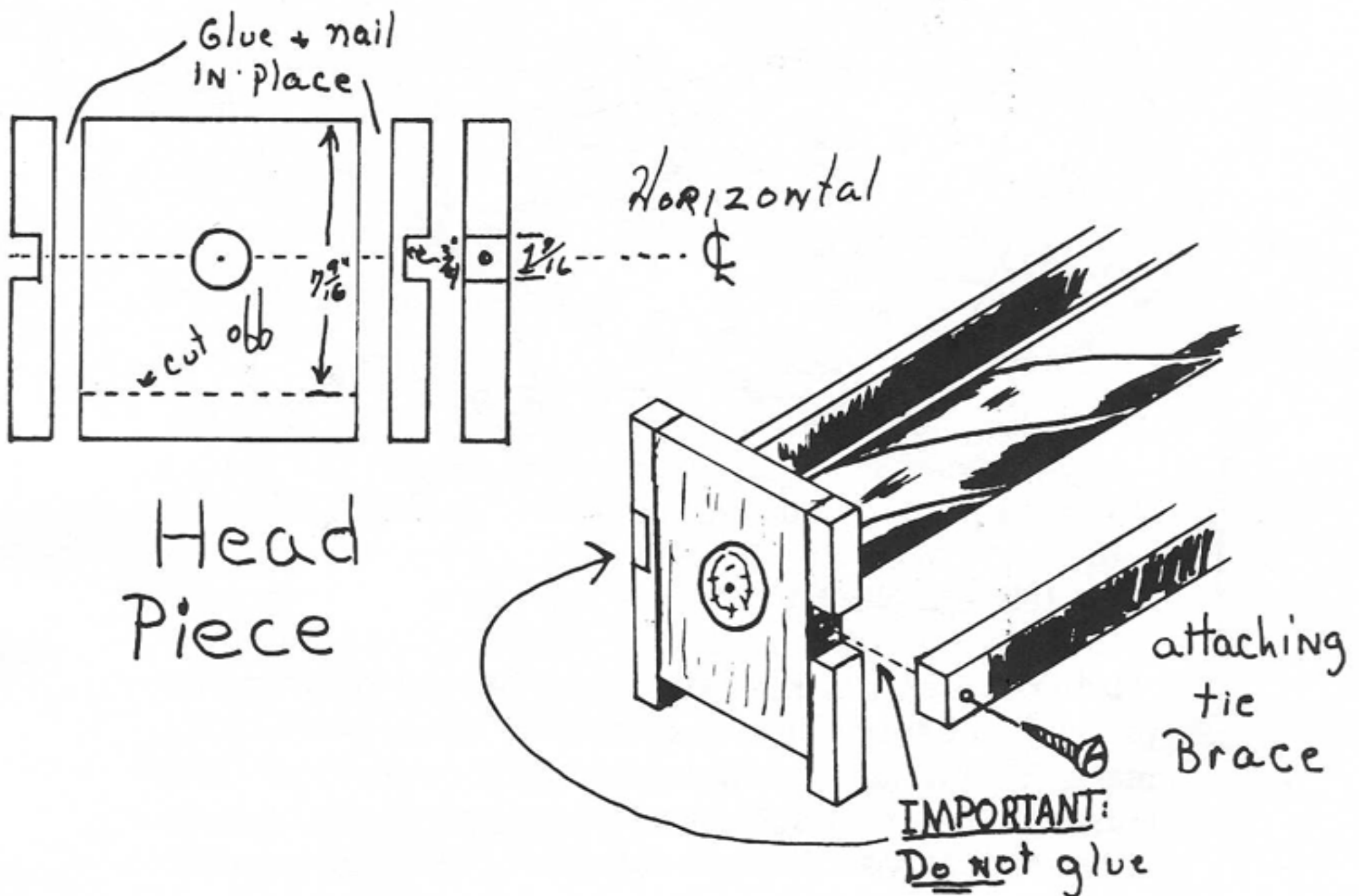

TIE BRACE

The tie brace is nothing more than two pine 1"x2" strips that hold the hand piece and the head piece together so the indexing guide will remain in its proper position, and still be able to turn freely. The end that is inserted through the hand piece has a slot cut in it so it can be glued and wedged in place as shown. The other end is screwed into place on the head piece so it can be taken apart if necessary. The tie brace should be 52 1/8" long.

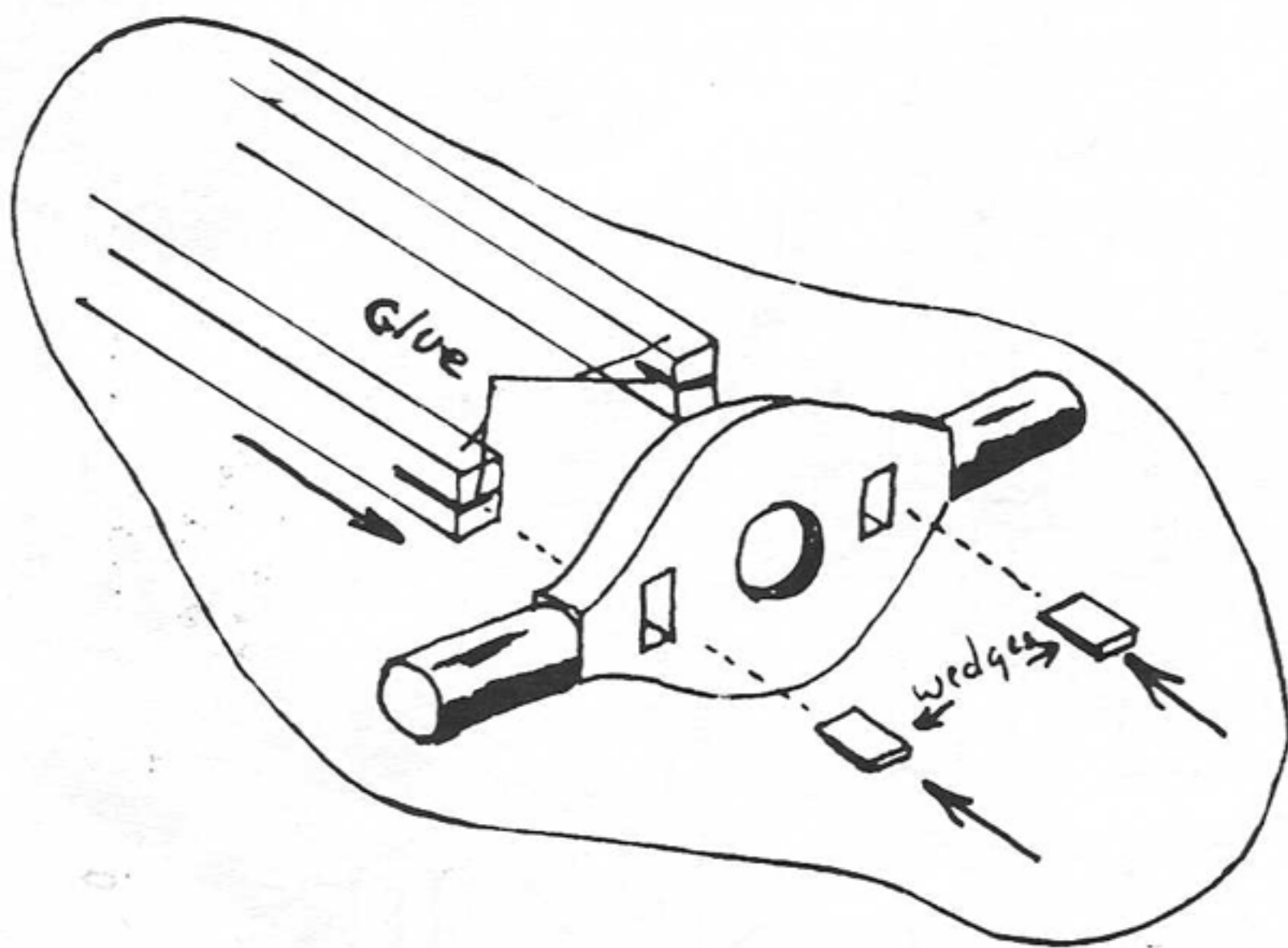

THE INDEXING GUIDE

I do not mean to try to scare you, but the following is probably the most difficult part of the whole machine to make. This is the piece that twists the cutting tool that cuts the rifling, and is the part that determines the amount of twist that your barrel will have. For the sake of

INDEXING GUIDE CROSS SECTION

full scale

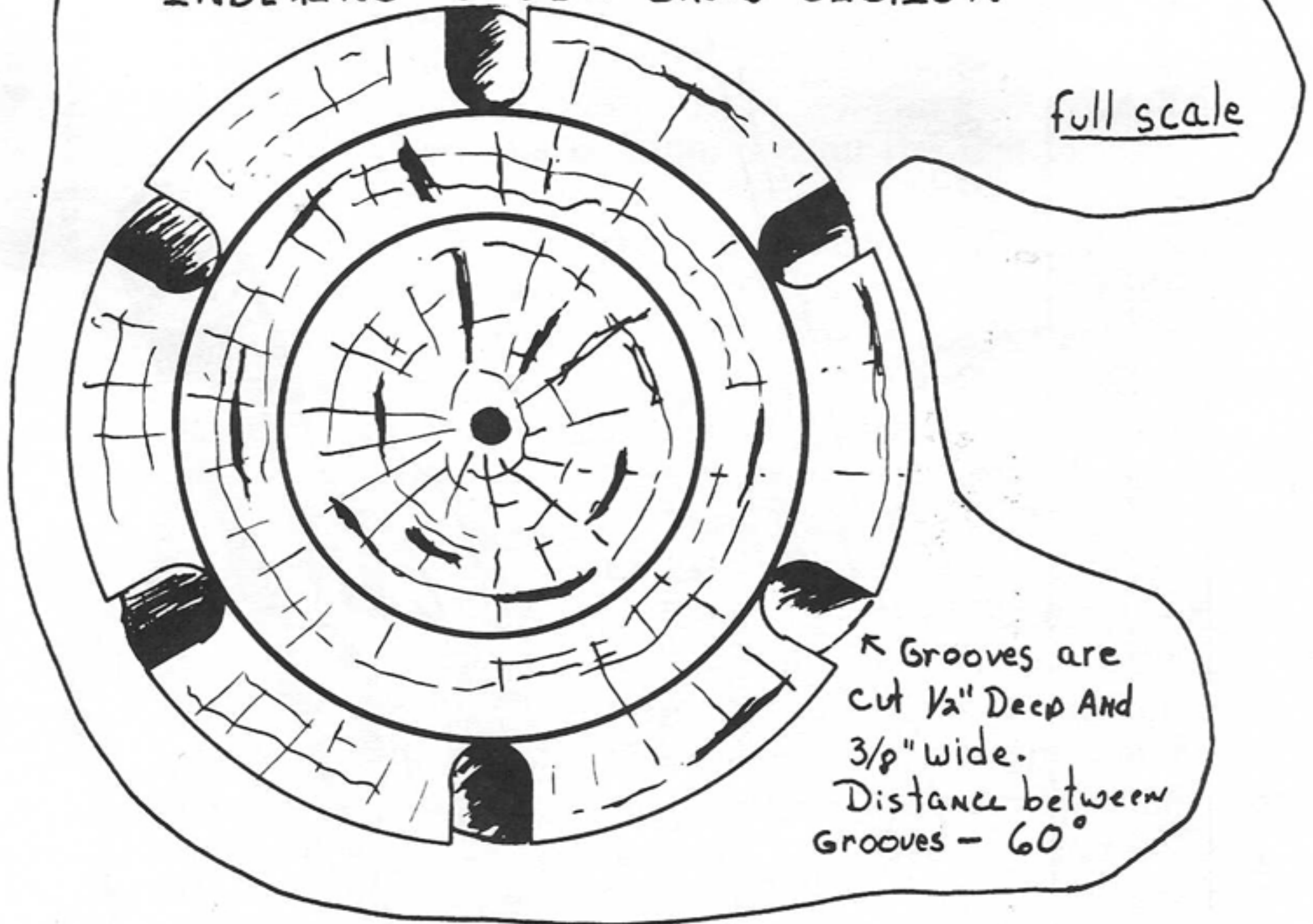

← Grooves are cut 1/2" Deep And 3/8" wide. Distance between Grooves - 60°

popularity, this guide has a twist of one complete rotation in 48". This is the twist that is most frequently encountered in muzzle-loading firearms. With this type of setup you should be able to rifle barrels up to 46". If you want to rifle barrels that are longer than this then you will have to make a longer cylinder and make the tie brace longer. Well, getting back to business, before you start to cut the grooves, you should turn the ends in a wood lathe to the proper diameters. When this is done there should be a section that is 48" long and 4" in diameter in the center of the guide. You now have to draw a line that is parallel to the axis of the guide from one end to

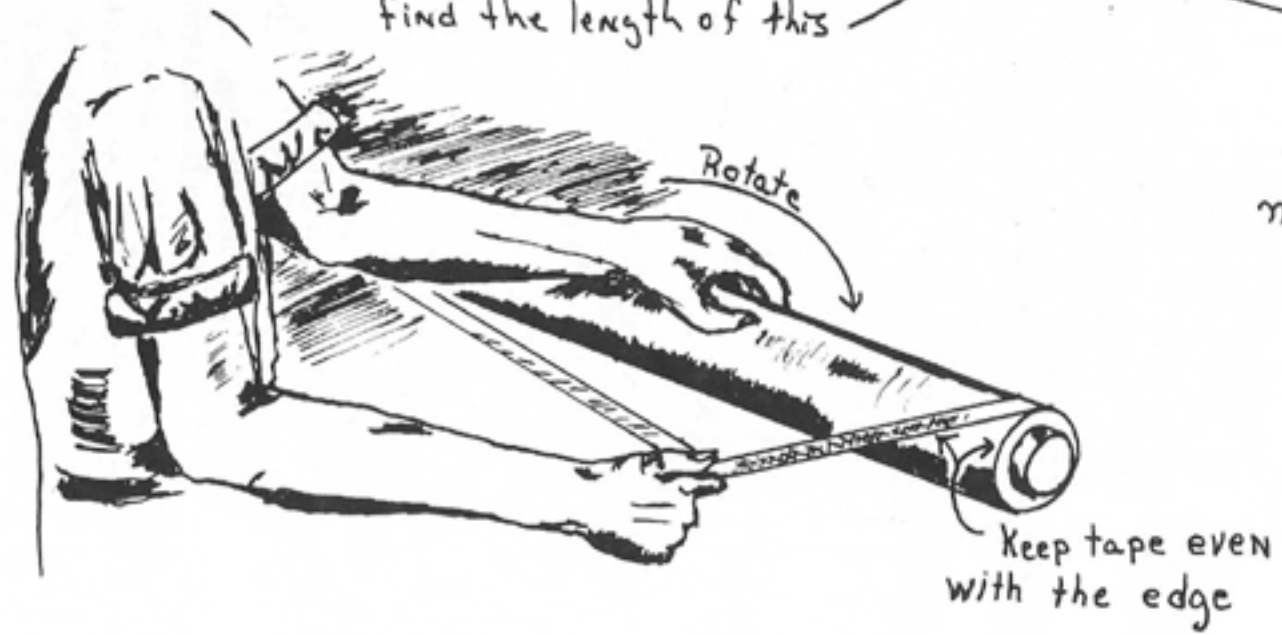
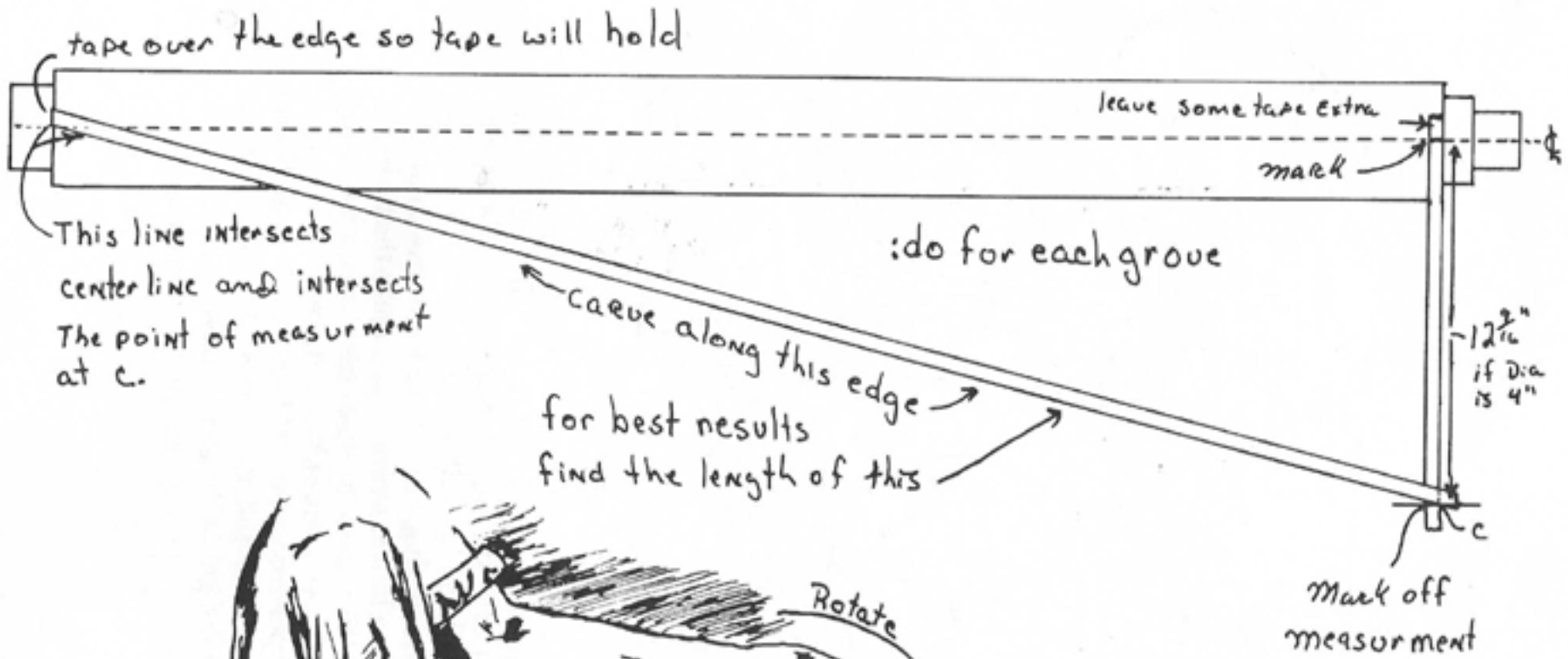

the other. This is a reference line. Now using the dividers, divide the guide into six equal sections as was done on the indexing head. This should be done on both ends of the guide. When this is done, lay out the rest of your reference lines.

In order to lay out the grooves it will be necessary that you have some type of tape that is from $\frac{1}{2}$ " to $\frac{3}{4}$ " wide and that will not stretch. A good tape to use is the type of tape that has a good stout cord running through it. This will not stretch. Regular masking tape is also good enough. Another type of tape that you can use is adhesive tape. This will tend to stretch a little bit but it can be tolerated. In order to get a better idea of just what you are going to be doing with the tape, look at the illustration on laying out indexing guide. Since you already have the length at which you want one rotation (48"), all you have to do is find out the circumference of the guide, and then stretch this measurement out to make a straight line that is perpendicular to the axis, as shown in the drawing. Then from the opposite end of the guide run a piece of tape to the end of the short piece of tape so you have a triangle that has a 90 degree angle in it. If you really want to find the exact length of this part (which is the hypotenuse) it can be found by using the formula,

$H = \sqrt{(48^2) + (\text{guide circumference}^2)}$. If you are using a 4" diameter piece of wood, it will have a circumference of 12.5664". After you have used this formula you should have a hypotenuse that is 49.62" long. The angle of the twist on the guide will be 15 degrees.

Once you have the tape laid out, hold it as shown in the drawing and rotate the cylinder, until you have made one complete circle, and then carefully press the tape down to make it stick. Once you have the first piece of tape secured on the cylinder, do exactly the same thing, in the same manner in which you did the first piece of tape, for the other five divisions on the guide. If you did it right, the distance between any two pieces of tape at any point on the cylinder will be exactly the same.

Now comes the tedious part of the process, carving the grooves. Since the indexing pins are $3/8$ " in diameter, and $1/2$ " deep the groove will have to be just slightly wider. To carve the grooves, use a $3/8$ " gouge, and for your own sake, keep it razor sharp.

LEGS

I have left the type of legs that you can put on your machine to your own discretion. The two types that I tend to recommend are the old style rustic legs, held in place by glue and a wedge as pictured in the drawing, or if you prefer, you can use the style of legs that are common to saw horses. If you want to be able to store the machine easily, do not put any legs on it and just set it on a couple of saw horses when you want to use it.

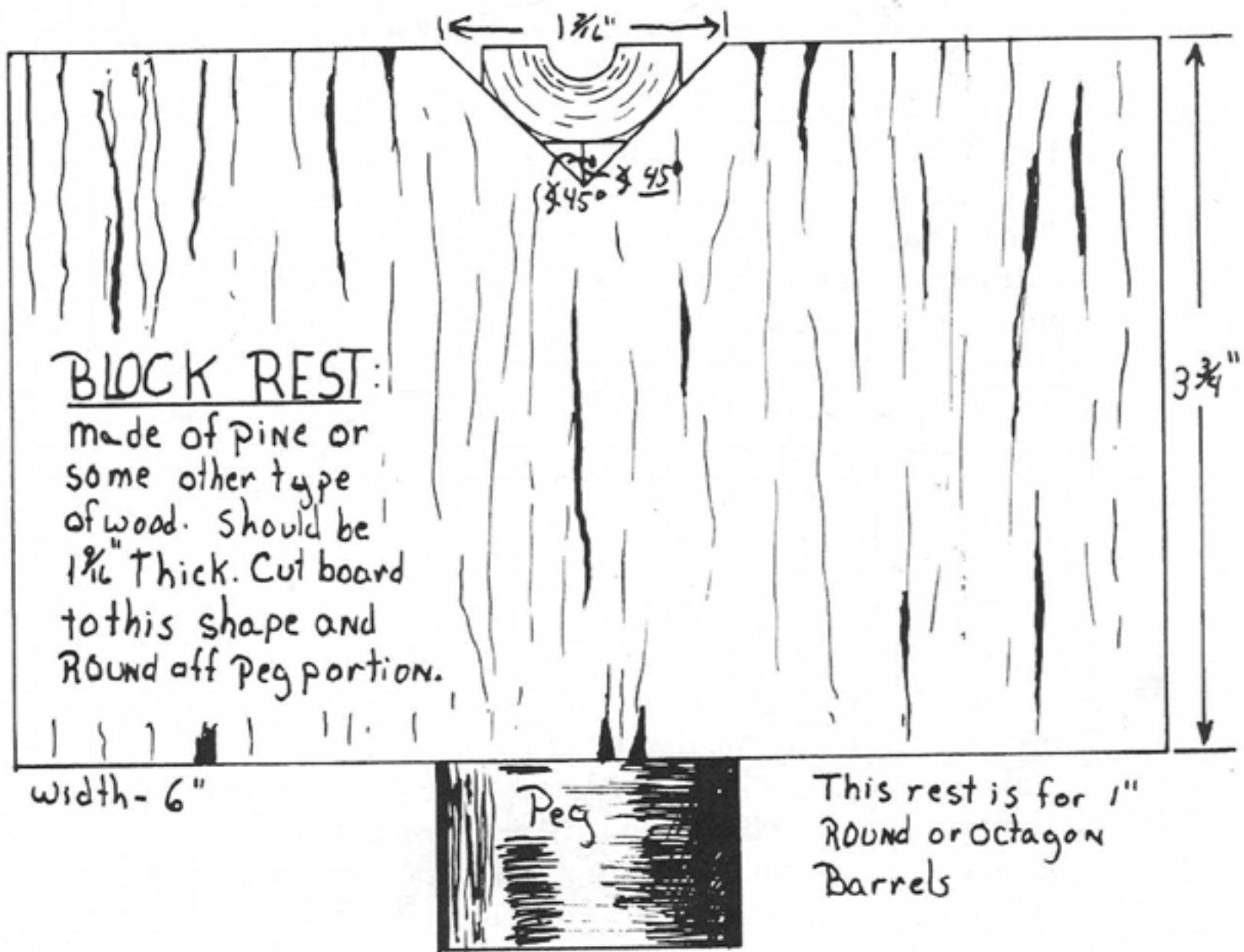
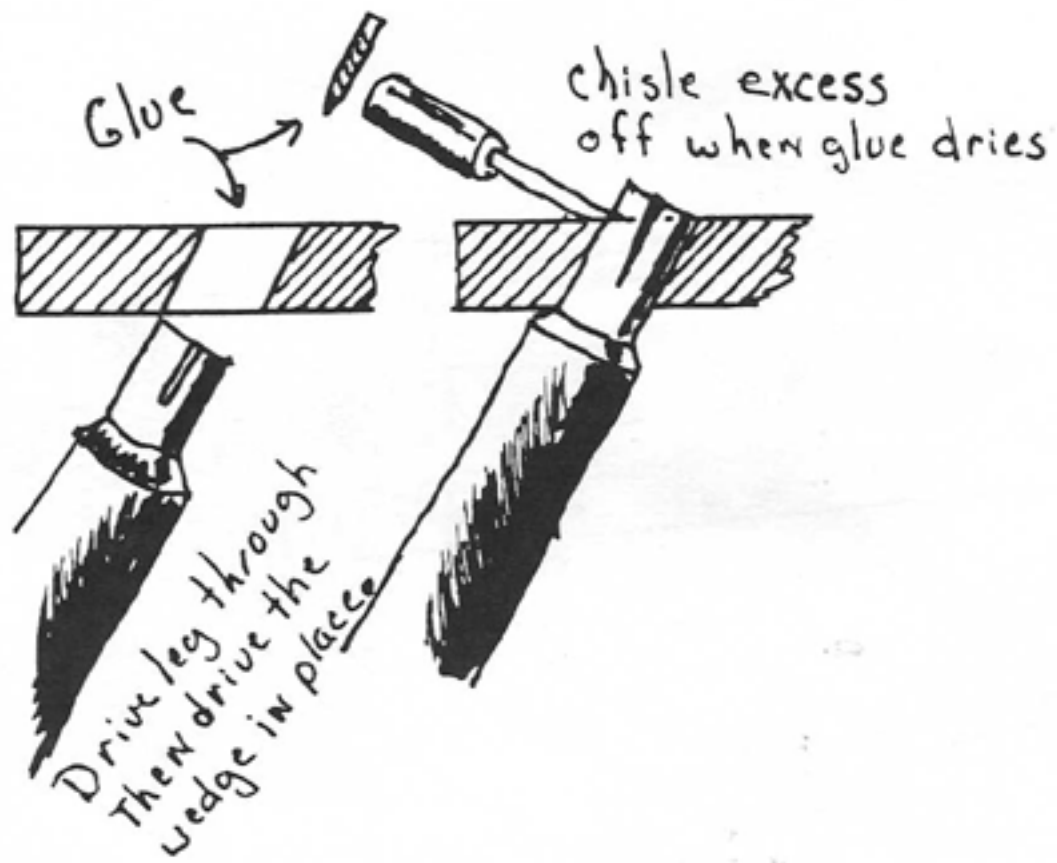

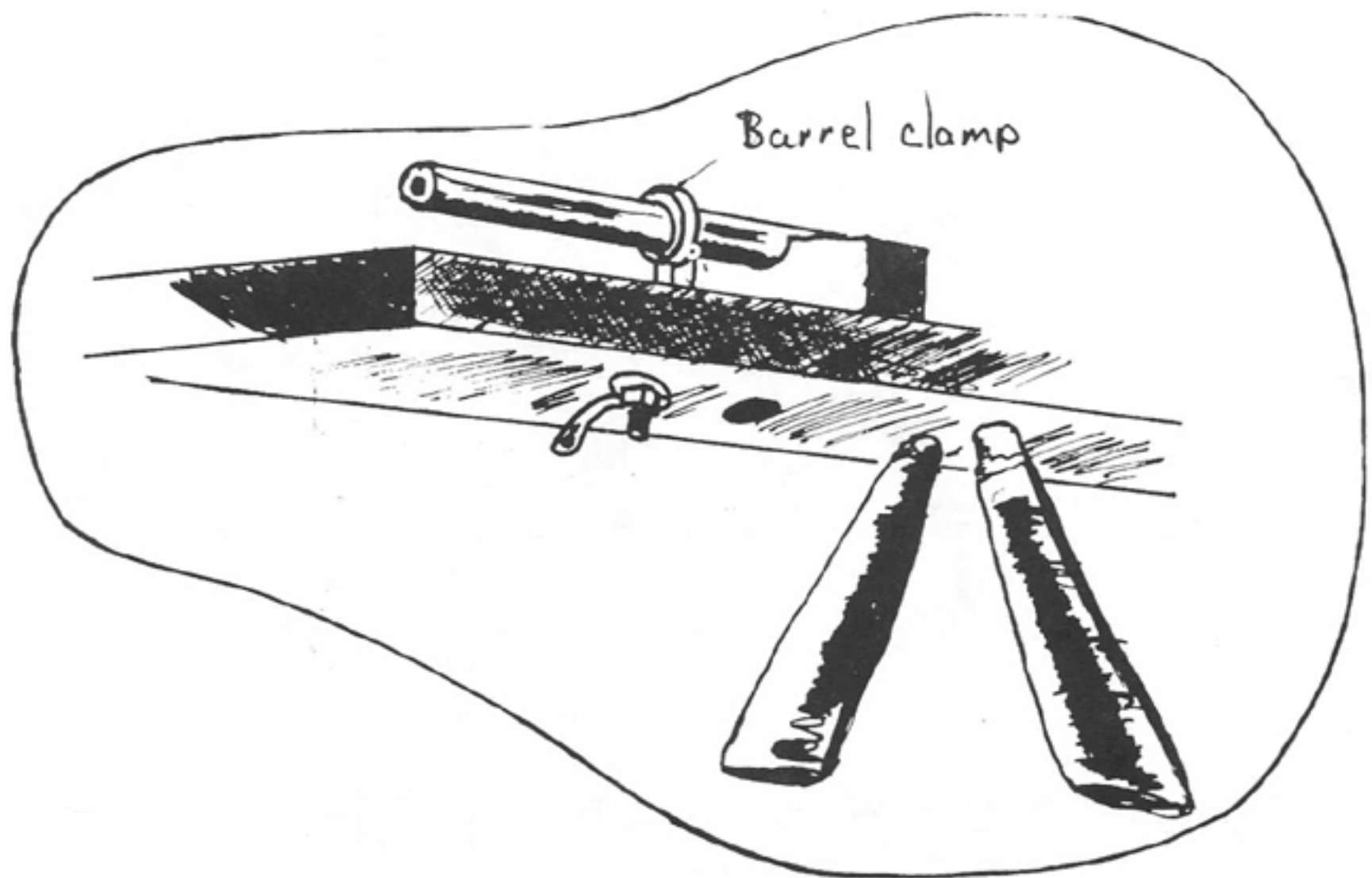

BARREL CLAMPS AND BLOCK RESTS

These two items should be made exactly as shown in the drawings. The barrel clamp can be made by sawing a piece of three inch water pipe and welding it to a half an inch bolt if you happen to have that sort of scrap lying around. As for the block rests, make them as shown in the drawing. In order to use this one for a barrel of smaller diameter, you will have to shim it a little.

THE EXTENSION ROD AND RIFLING HEAD

The extension rod for this type of machine is nothing more than a piece of $\frac{1}{4}$ " dowel rod or what ever other diameter rod that is necessary to fit into the bore of the barrel that you are rifling, with two wood screws welded or brazed to both ends of it. Its function is to give you some space between the rifling head and the indexing guide. This is a fairly simple thing to make and should be made as shown in the drawing.

full Scale

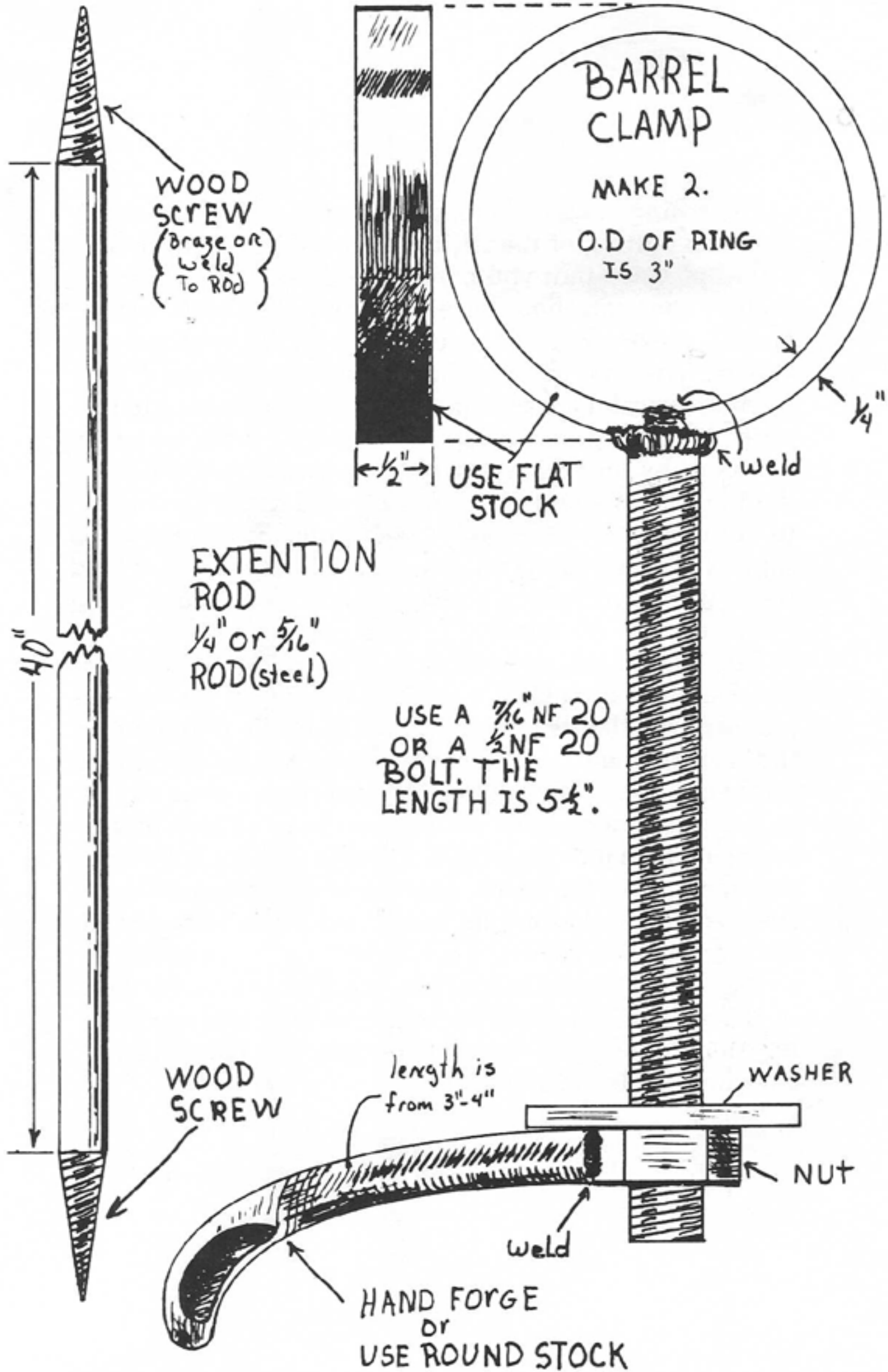

The rifling head is the part of the rifling machine that does the cutting of the rifling grooves. There are many different ways that you can make these, and whatever method that you should use will work quite well. In this booklet however, there are only two of the types that are shown. The first one that is pictured is one that, if you want to stay along traditional lines, will be the one to use with this rifling machine. The principle with which it works is, by moving the two shims away from the middle towards the ends of the head, will cause the cutter to cut deeper. A little better way to use this head is to replace the two shims with two thin pieces of wood between which you place a piece of thin paper each time the head is to be raised.

This type of rifling head can be made, as is shown in the drawing, by taking a straight branch of an oak, or hickory tree that is slightly larger than the diameter of the barrel being rifled. Some other type of hard wood will do if you do not have either of these two in your vicinity. Strip the piece of wood that you have chosen of any bark, and trim it down until it will slip, without any slope, into the bore of the barrel. Now, split this piece of wood from end to end along its center axis, and with a well sharpened knife, carve the center four inches of each half so they are as shown in the drawing. This space, because of the way that it is cut, acts to raise the rifling cutter up as the two small wooden wedges are moved away from the center of the tool.



cut twig AND
Trim off bark
(oak, or
Hickory)



Split down the
center

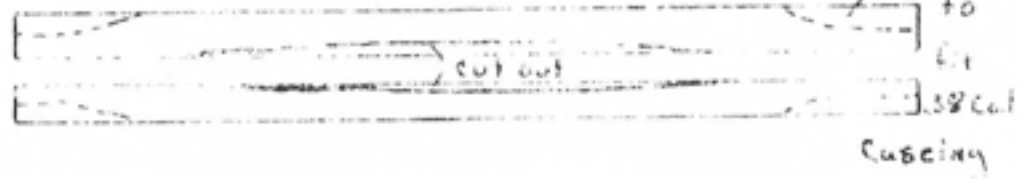

Drill out End of casing and Epoxy into place



Glue back to geather

Slip two tight shims
in the middle of the
space these are used
To Raise the cutter

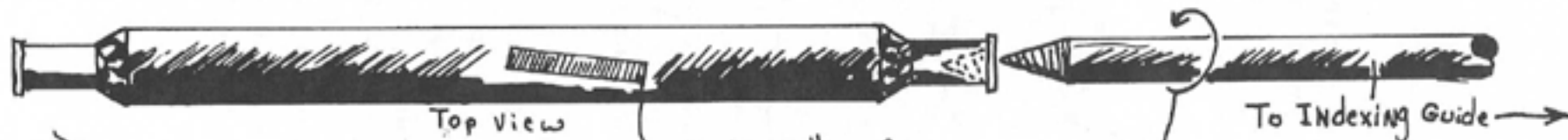

Screw into Rifling Head
and into the guide.



Make cutter from
afine Jewlers file

Break

Once that the groove is cut, glue the two halves back together with an epoxy type glue. When this has dried, whittle the ends down as is shown in the drawing to accommodate a couple of cartridges with there ends removed. Glue these in place. These will keep the rifling head from splitting apart. With this done you must make the cutter. This is made from a very fine jewelers file. Break the file off so you have a piece that is about $\frac{3}{4}$ " long, and grind both ends smooth. This cutter must be inlaid into the rifling head so there is only about a quarter of it sticking above the surface. In order to make the cutter follow the amount of rifling that is being done, it is important that you set the cutter at the same angle of the rifling. Here is a list of the angles at which the cutter should be set for the different calibers;

TWIST = TURN IN 48"

.36	1°
.40	1°
.45	1°
.50	2°
.54	2°
.58	2°

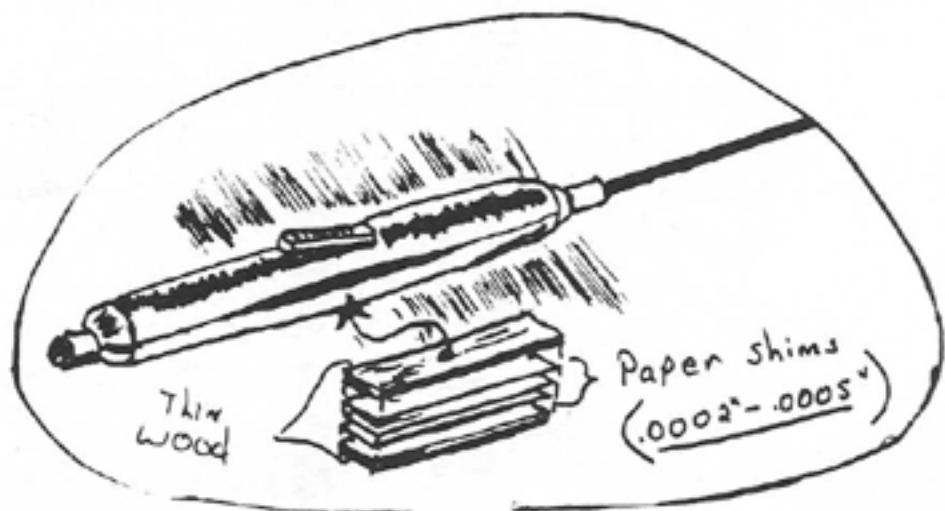

If the twist of the rifling is less than this, the angle of the cutter will be less, and if the rifling has a greater twist, such as 1-32", the angle of the cutter will be greater. When you inlay the cutter it should be in such a way that there is a good tight fit without having to fasten it down in any way.

work out a new table of functions for the various twists. For example; if your guide diameter is $3\frac{1}{2}$ inches it will have a circumference of $3.5 \times \pi (3.1416) = 10.9966$ inches. If you divide this number by each of the length of twists that are shown in the table you will have a new list of functions for a guide that has a diameter of $3\frac{1}{2}$ ". To get rid of those decimal points and convert them to good old inch and feet measurements, multiply just the decimal portion of the leg length by sixteen (16). When you do you will more than likely wind up with a hole number and more decimals. By rounding off these decimals to the nearest whole number you will have the number of $1/16$ inches that the original decimal equals.

GOOD SHOOTING AND GOOD HUNTING