

## CHAPTER 5

### Silver Soldering

A lot of modelmakers think that silver soldering (from now on SS means silver soldering) is a black art that they try once, make a mess of and don't do it again, or just think it is too expensive to gear up for.

I will tell you now, I am tight as a ducks a\*\*e, and that's watertight when it comes to SS. Once you have the initial bits, the running costs are minute. I showed on the last post how strong the joints produced by correct SS can be - many times stronger than soft soldering or glue. Now I will refer to the pictures of my bits and bobs.



Pic 126 is my collection of soldering things, I do have a proper home made brazing hearth but it was too heavy to set up here, and you won't need one anyway. The last time I used it - and the big propane gas torch shown here - was when I made boilers a few years back.

The ones connected to disposable cans are a standard plumber's blowtorch, which I use for the large bits, and a can adaptor to allow me to fill the two small blowtorches with butane/propane mix.

The little orange one is what is now called a 'Chefs' blowtorch and is what I use the most, while the little pencil one I used to use for building railings while they were still attached to the model boats.

The next bit in the line-up is my 'mobile SS hearth'; in other words, a couple of firebricks from a builders merchants. If you go there and ask if they have any broken ones they might even give them to you. DO NOT use household bricks; when they get hot small bits can shatter off them and fly in all directions. I use this set-up all the time and move it about my workbenches to where needed. As long as you don't get them too hot and keep away from flammables they are ok.

The big bucket is a recycled (nothing goes to waste) popcorn bucket that is filled with my quenching water and is normally next to the mobile hearth. The one on top that looks like someone has piddled in is my acid pickling bath for removing flux and for cleaning the pipework. The contents of this is explained in the next paragraph.



The items in Picture 127 are now going to be explained in an easy to understand manner.

**Steel wool**; this is used to clean the parts before joining. Any oil or grease or sometimes even fingerprints can stop the joining of metals with SS. So degrease first, then a rub over with wire wool (cabinet makers if possible - some others are treated with oil to stop them going rusty), then assemble the bits together. Be careful with wire wool around heat; it catches fire very easily and is usually a pig to put out.

**Citric acid**, used to be able to get this anywhere but now only readily available from chemists. When you go in, go in filthy like you have been under a car for a week and explain to them that you need it to make a pickle bath for soldering. You will get some weird looks and whispering between the staff; the dispensing chemist will usually be called to have a word with you but as soon as he sees how filthy you

“Bogstandard”: Building a Steam Engine from mainly Junk Materials  
Chapter 5

are he will let you have some just to get you out of his shop.

The reason for this is because citric acid is a main component in the use of heroin-based drugs. We use it as a pickling bath and I mix it about four teaspoons to half pint of water. In a sealed container I find it lasts for many months, and I only throw it away when the things growing in it get to look a bit dangerous.

The thing next to it marked flux does in fact contain - yes, you guessed it - **flux**, but in an emulsified state. It normally comes as a white powder, and should be mixed with water to a consistency of thick cream. Again I find that putting it into a small sealed container (film canisters are ideal) it will keep for months; just stir it up just before use. The purpose of flux is to stop oxides forming on the surface of the metal and to clean it at the same time, allowing the SS to bond into the surface of the metal.

There are many types of silver soldering fluxes but I would go for one of the Tenacity ones. I use Tenacity 4a, which is really for stainless steel and is fairly aggressive, or the most popular of its type is Tenacity 5, designed for use with normal steels. What these fluxes have over the other general purpose ones is that they can still do the job of cleaning the metal at much higher and prolonged temperatures than the general purpose ones. But as I said before they are slightly aggressive and need to be cleaned off before it thinks your copper pipe is muck and starts to eat it away.

It is just applied to the local area to be joined with a small brush.

Next we come to the most confusing bit - the **silver solder** itself. It comes in all shapes and sizes, melting points and even as pastes (but these do have a fairly short shelf life). The reason for the different temperature ranges is to allow multiple parts to be SS onto a construction at different times. You would use a high temp one to begin with, then with each subsequent addition you would use a lower temp than the previous one. But for our purpose we will stick with general purpose or bogstandard Easy Flo.

Most people go for the 1.5mm rods costing up to about £3 per rod, and end up filing most of it off the job they have just SS. It is just too large for what we want to do. I use 0.5mm Silver Flo wire; as you can see it costs 82p for a 3 foot length, and would do all the joints on at least ten of these engines. For slightly bigger joints it also comes in bigger sizes.

You will notice at the front of Pic 127 are what look like springs; they are in fact coils of SS wire. I wrap the wire around the next size down of tubing that I will be using, and about 2/3rds of one coil is enough for one pipe joint.



Onto Pic 128. On here I have assembled the parts and put one coil onto each joint. All that is left to do is paint a small amount of flux around the joint and stick some heat onto it. You will notice that I have protected my table because of the flux.

It isn't worth taking pictures of the process because by the time you reach the temperature, it is all over but I will explain the principle.

If I was doing one of the stand off flanges, I would start by heating up the flange itself to a very dull red - you can only just see the red. At this point the flux has dried up and started to turn to a liquid.

Because the copper is a better heat conductor than the steel, I will let the copper take its heat from the steel, so I will move up towards the joint. As you do you will notice that the flux is cleaning the area and all of a sudden the silver solder will melt and flow into and around the joint. Once this stage has been reached, take away the heat. If you reach a distinct bright red colour, you've already overcooked it.

Pick the bit up with a pair of pliers (they get very heavy if you use your fingers!) and drop it into the quenching water. This will knock most of the flux off, but to do a good job transfer the bits to your pickling

## “Bogstandard”: Building a Steam Engine from mainly Junk Materials Chapter 5

tub. I have left bits in this for more than a week and they were still ok when I took them out. A couple of hours usually does a good job.

One point to mention: if you SS silver steel or any of the high carbon types, let the article cool down before dropping it into quenching water, otherwise you might find the component has gone glass hard and very brittle.



Now onto Pic 129. Here are the bits straight out of the quench. You will notice on the standoff ones especially the bright silver area on the steel and the clean area on the copper above the joint - this is the flux doing a great job.

You will notice no big blobs to clean off, just nice clean fillets. Just a quickie pickle and polish then ready for the next stage.

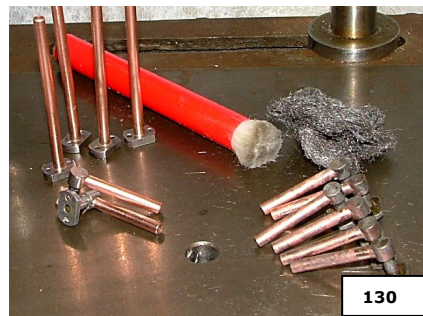

Pic 130 is out of the pickle after an hour, and just started to clean them up.

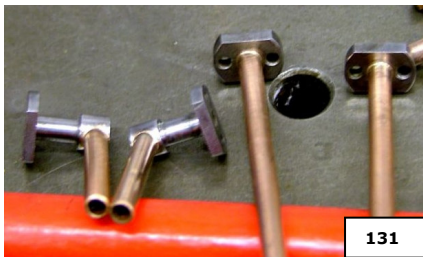

Not a very good Pic 131 but you can see how this method produces lovely fillets with absolutely no wastage, and very little clean up; just a quickie polish and they are done.

### **Silver Solder - Problems**



Question: Picture 132 was sent by a reader, asking what was wrong?

Answer: You do really need real firebrick (the type used to line fire places, wood stoves, etc.); it doesn't take the heat away but keeps it very local. In fact, when you are doing something larger, the bricks glow bright red around where the heating is taking place. The size of pipe you are doing there can easily be done with the little blue torch you have there.

“Bogstandard”: Building a Steam Engine from mainly Junk Materials  
Chapter 5

By the look of the deposits of black on the brick, it suggests you are using a carburising flame. The black you see on my bricks is caused by twenty years of use. In your case, this is caused by not enough air in your gas mixture. Check the air supply holes around your nozzle to see if they are blocked - sometimes the nozzle itself can be knocked into a bad position. If the nozzle has a securing screw on the outside, slacken it off and try sliding the nozzle back and forth until you get a nice bunsen blue area in the centre of the flame. The tip of this centre cone is the area of maximum heat, and this is the part of the flame that is used.

From the look of the workpiece, the flux just isn't doing its job. There should be nice clean areas around the joint, as I showed in my post.

It might be you are taking too long in heating up, and killing the action of the flux. That is why I use an aggressive type flux. For small jobs like this, if it isn't all over and done with in ten to fifteen seconds, you are most probably cooking the flux.

What you can do with your silver solder rod is give it a real good going over with a hammer until it is very thin and cut off a very small piece and place on the job. It just might be the big rod being put onto the joint is soaking away what heat you have there.

Hope this helps for your search of the perfect joint (for medical reasons of course).

**Editor's Note:** Some SS Health and Safety considerations, courtesy Polly Model Engineering Limited at <http://www.pollymodelengineering.co.uk/global/technical-notes/basic-silver-soldering.asp> (John also references this site a little later on.)

“Common sense is the best thing here:

- never breathe fumes from any source, particularly if using cadmium-containing alloys,
- use good ventilation and stand back from the work not over it,
- flux can irritate the skin and prolonged contact should be avoided, and
- the heat from soldering a large item can be overpowering and exhausting so be aware and be careful.

Some people wear a so-called survival blanket as an apron when working or even a sheet of aluminium foil to reflect the heat.

Don't be tempted to touch anything, even with gloves on, unless you are sure it really is cold.

Always lay down sticks of solder with the hot end away from you on the hearth.”

## Flanges – Drilling Out

I forgot to mention in the post about the stand off flanges about drilling them out.

As the tubes were silver soldered into the flanges, the end of the tube protrudes inside the steamway. You need to run a 2.8mm drill down the flange to cut off the end of the tube inside to allow full steam flow.

Be careful you don't drill all the way through. You only need to take off the first bit of tube you come to. Put a drop of milk down to act as lubricant; otherwise, you might break off your drill inside trying to cut the very soft copper.



Steam Control Block – Part 1

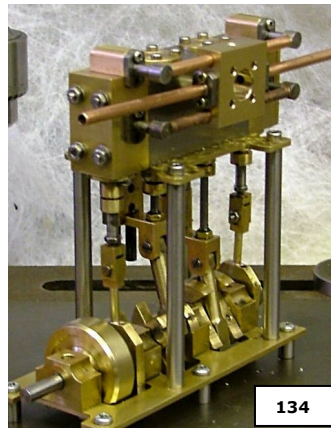
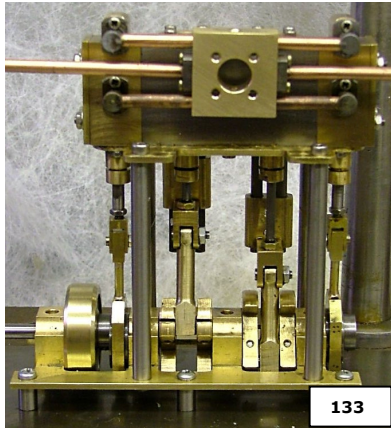

I have included this time a couple of pictures (133 & 134) to show how far I have got with the steam control valve. Doesn't look much, but trying to get all the holes missing each other inside and also making it fairly easy to make took a lot of working out; hence the delay.

I have decided to use the main block and the two piston valve blocks to act as jigs while it is all soldered together, so really all this needs to be done before engine assembly. I am lucky; I have a second set of parts I can use.

The reason I have done this post is to show how close we are to finishing.

STEAM CONTROL BLOCK - BRASS OR MILD STEEL - 1off

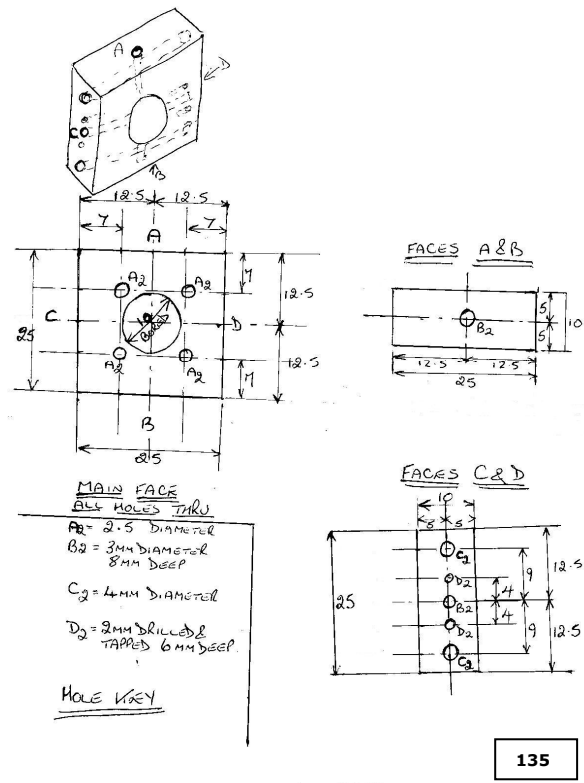

I had forgotten that I had a few pictures left in my camera, so I have decided to make a post out of these. The blocks need to be made and all completed before I could carry on anyway, because the bits that fit to it have to be lapped into the main bore and the soldering has to be done first just in case we get a little bit of distortion in the main bore. I suppose you could bore it after soldering but it might be a bit difficult to hold well enough.

The sketch (Pic 135) shows all the positions and sizes, thru a key. They are drilled in a specific order, and that is shown in Pic 137 (next page).

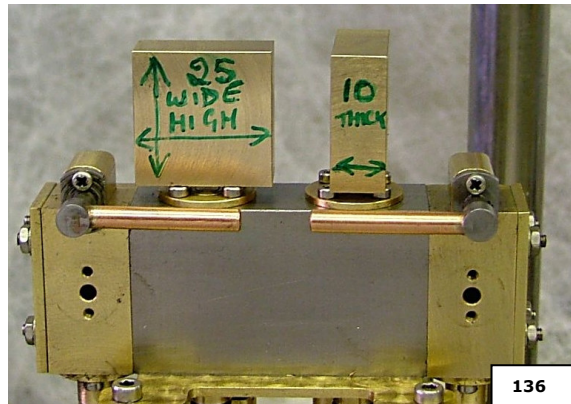

Pic 136 shows the size of blocks required. I have stated that these can be made out of brass or steel, preferably brass (a lot less hassle to drill and tap).

Just a quick warning when you come to bore the main hole. When you are putting the larger drills thru to get to size (over 9mm) you will start to hit the bottom of the four holes drilled on the centre of each side - take it very steady. Also I would recommend drilling the 4mm tube holes from each side rather than deep drilling all the way thru. Another thing to point out is that the 3mm holes that these pass thru, have to be

“Bogstandard”: Building a Steam Engine from mainly Junk Materials  
Chapter 5

sealed on the outside of the block; how to do this will be shown later.

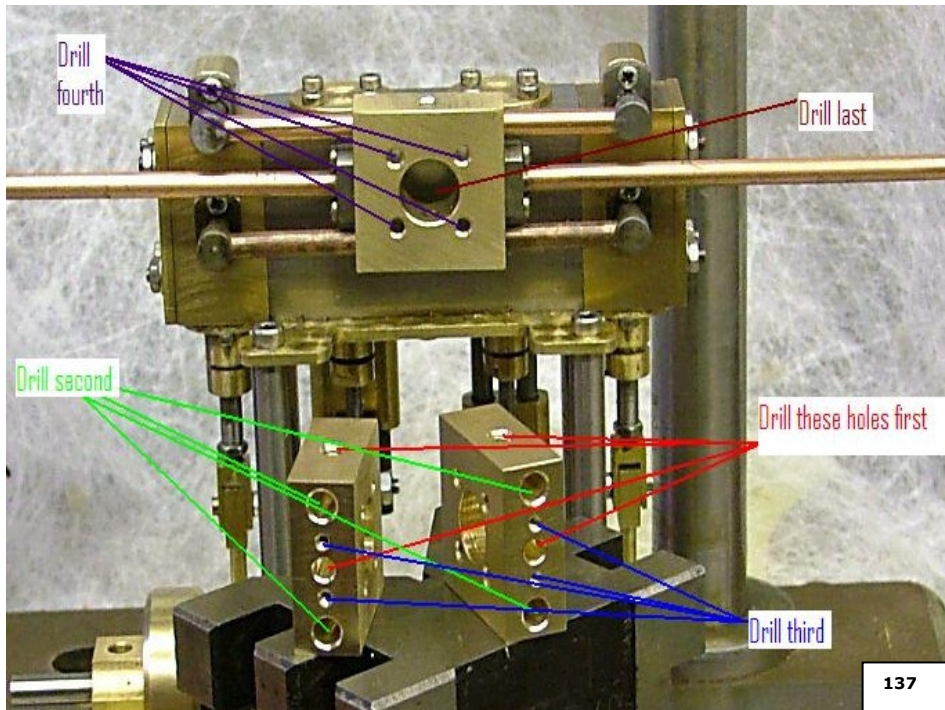

By the way, this engine is starting to look a bit battered, maybe caused by being the prototype and has been taken apart more times than I care to remember, hopefully the other will look a lot better.

**Comment – Pickling Solution Options**

*Going back to silver soldering for a minute.... You mentioned using citric acid as a pickling solution John. I assume anything that is acidic will work, so what about something easier to get hold of such as acetic acid (vinegar)??*

**Response – Pickling Solution**

Never tried it, except on my chips.

What I do know is that when I used to visit a plating shop, they had pallets of rotting oranges and lemons hanging about the place. These were being used for the same process as we are doing - cleaning. All I really know is that I have only ever used citric acid, and it works, and works well.

Sorry I couldn't answer your question any better E.... All I would suggest is try it, and see what happens. It might even get the steel to come out clean. As with citric acid, coupled with the heat process I think, or maybe a chemical process with the flux and copper, steel comes out with a lovely chemi black finish. Seems a shame to clean it off back to polished steel.

BTW, citric acid is not difficult to get hold of at all; just tell them what you want it for, and you shouldn't have a problem. Just buy a couple of boxes of it and it should last a few years, as I do.



## Steam Control Block – Soldering

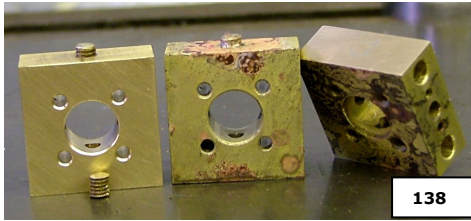

Pic 138 shows how to seal up the bit of the transfer holes that aren't required. I tapped the outside bit of the hole 4mm and screwed in a bit of brass threaded rod. You can just use a bit of rod if you want, or even make a feature of it by turning up a little cap with a spigot on it, your choice. I use screwed rod to stop it falling out in subsequent reheating. Don't block the steam transfer holes with the plugs.

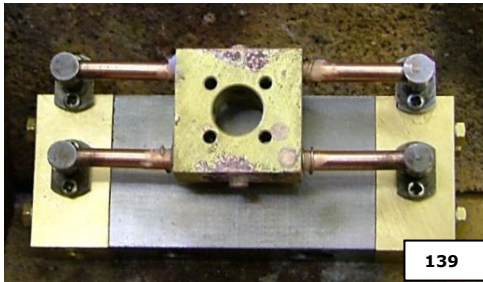

Picture 139 has the block, mounted to the assembled bits of the engine so it acts like a jig to hold everything in place. Without it you would end up with a real mess with nothing lining up. The bits of the engine will get very little heat onto them, so shouldn't be a problem. Don't forget to centre the block on the pipes so it looks nice and neat.

As I assembled it I put a bit of flux onto the pipe ends. Also notice that I have used about 1 1/2 turns of wire; this is because the pipes penetrate a fair way into the block. Really it needed two turns, as the fillets ended up fairly small on the finished block - but they were fully sealed, which is what we are after.

Now the heating up bit. Because it is a fairly large block, I used my plumber's type torch, the one with the screw-on can. All I did was to play the torch onto the area between the big hole in the middle and the outer edge of the block in a rotary motion until I just started to see a faint tinge of red; then just play the flame onto the block at each corner until you see the solder run. All done in 20 to 30 seconds. There is no easier way to describe it; just don't play the main part of the flame onto the pipes as you will cook the joint. Then put the whole lot into quench water.

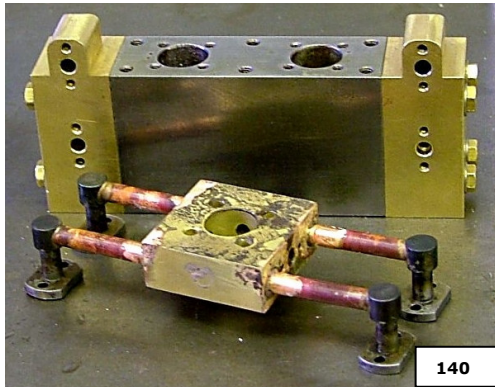

This now brings us to Pic 140. The block has been taken off the 'jig'. You can see that the flux has done its job keeping the soldered area clean, and because the heat was kept directly off the pipes, the joints on the flanges are totally untouched. The solder around the plugs has re-melted but they still have a good seal.

You will notice that the 'jig' has what looks like a burn mark on it. In fact all it is a waxy like substance that just wipes off with a cloth - I think it is just a bloom caused by flux vapours.

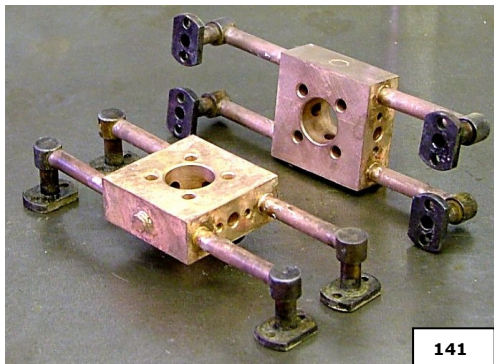

Notice all the good joints. I re-measured the main hole and there was no detectable deformation, so looks like we are in with a chance of making a good valve. Just got to wait until I can get the bits made.

Pic 141 shows the assemblies after an hour in the pickle; looks really bad, but a wipe over with steel wool brings it up just like new.

By the way, both these assemblies fit both of my engines perfectly; they are even interchangeable. So the 'jig' worked!

“Bogstandard”: Building a Steam Engine from mainly Junk Materials  
Chapter 5

**Comment – Chamfer?**

*Morning PD's.....John....when we look at 'sketch for steam control main block.jpg'.... in the listing Faces C & D..... the drillings C2 for the 4 mm tube... are these not shown in the following 'all holes drilled ready for joining .jpg' (Editor's Note: Pic 137) as being pre-drilled with a healthy chamfer? D.....*

**Response – Chamfer**

You will notice that I always give all my drilled holes a good chamfer, usually because there is something bolted to the face and if not well chamfered it tends to hold off whatever is fixed to the face, and usually causes problems. But well spotted about the larger chamfers for the holes that are to be silver soldered. I forgot to mention about them - they are there to promote good penetration and a stronger joint. With you eagle eyed lot, I can't get away with anything.

To all following this lengthy build.

I know that this large assembly does look a bit daunting, but if you follow a few basic rules and a bit of practice I am sure everyone will be able to assemble it. If you really don't think you are up to it, if you can get all the bits to me by whatever means possible, together with your 'jig' - I will gladly build it up for you. So remember, cleanliness of the parts and a good flux plus don't overcook it are the keys to good SS.

**Response – Silver Solder Type**

*(Reader had asked for comment on his choice for SS)* The stuff you have got there is absolutely perfect for general purpose silver soldering, such as we are doing here, but definitely a little on the expensive side. I would mail you some by airmail and it would be a lot cheaper, but I don't know if it would be picked up by customs or anti-terrorist agencies as being a suspect envelope.

I have just found this web site and although it reiterates most of what I have already said, does contain a bit more about the use of silver solder for larger fabrications like boilers.

<http://www.pollymodelengineering.co.uk/global/technical-notes/basic-silver-soldering.asp>

I did a few weight calculations yesterday about this engine, like on average two thirds of the material is taken off due to machining etc. and the cost of this engine will come to well below the ten pound Stirling I originally said. That is, of course, because I use recycled bits from the scrappy. The fixings and bits of rod will most probably end up at around ten pounds. If you had to buy all the materials from retail sources, maybe the whole lot would come to less than £50, but you would also end up with most probably enough left over materials to build something else.

But you can't include your time. That is, as I see it, many hours of pure bliss, enjoyment and sometimes frustration. But isn't that what doing your own thing is all about?

So don't worry about your SS; all of a sudden everything will click into place and you will be running round SS everything you can get your hands on.



“Bogstandard”: Building a Steam Engine from mainly Junk Materials  
Chapter 5

**Comment – High Silver Content Solder**

D.....

If the wire you have has 66% Ag then it most certainly is not **EasyFlo** and will/may have a much higher melting point.... possibly in the region of 720 deg - 780 deg C which would also need the higher temperature type flux.... Tenacity No. 5 or similar.

A further problem with the HIGH Ag content types is their reluctance to flow around the joint, especially if the flux gets exhausted. If you are SS brass tube with this stuff, then take extreme care as it will be very easy to melt the tube whilst trying to coax it to flow properly.

**EasyFlo** has 42% Ag + 25% Cd + 17% Cu + 16% Zn and has a melting range of 610 deg - 620 deg C

The Cd content in this material makes for very quick and easy flow of the material; however, be very sure to keep the area well ventilated..... **Cd is dangerooossee.**

Normal EasFlo flux will be Ok for this, but not for the higher temperature stuff.

A good supplier for all SS products is to be found at <http://www.cupalloys.com> . They do a complete range of SS and allied products and offer a good mail order service. A lot of useful info can also be found on their web site.

**Alloy type 842** is the equivalent of EasyFlo. **Alloy type 456** is the Cadmium free equivalent with a melting range of 620 deg - 655 deg C.

S.....

Control valve is done and tested. Not as great as I expected but it is a lot better than the disc type with two crescent slots. Here are a couple of pictures of the control valve.

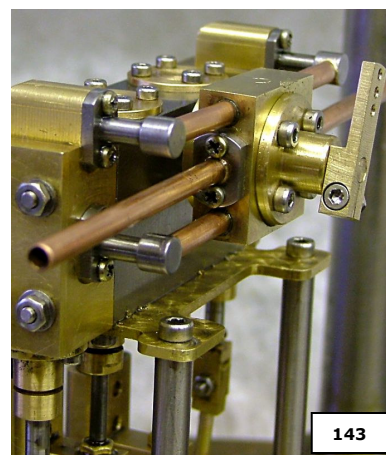
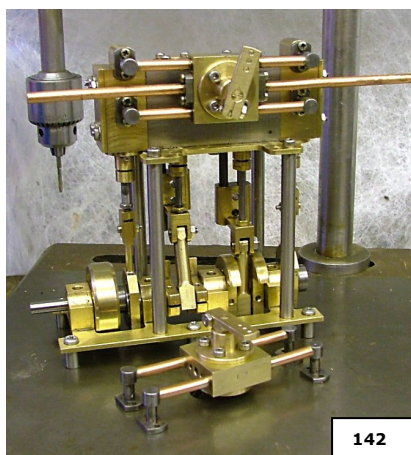

## Steam Control Block – Part 2

Here is the main part of the control block build. This one is a bit of a long haul. See [Pic 144](#) for sketch.

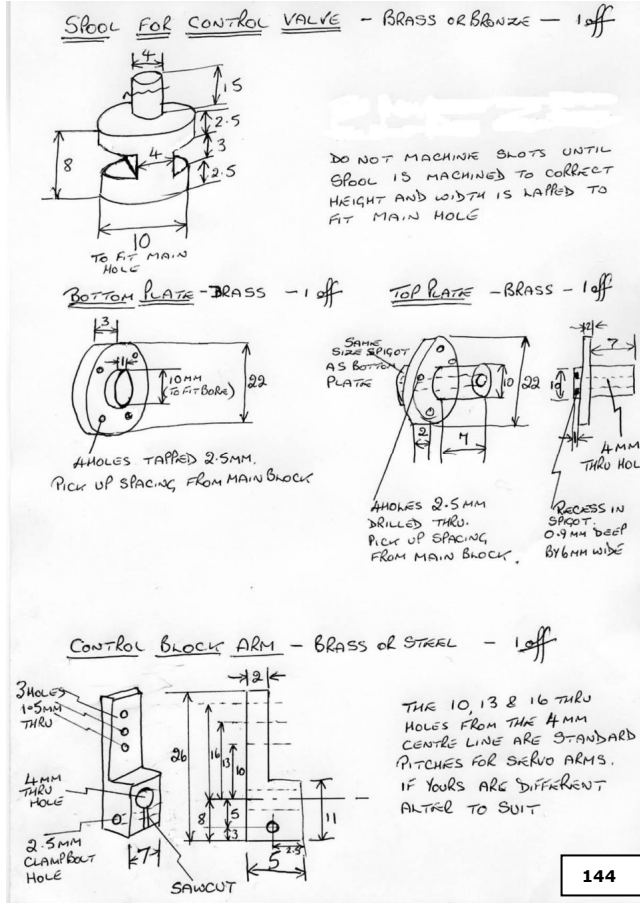

The major point on here is the recess for the 4mm bore by 1mm cross section Viton O-ring (purchased from Blackgates Engineering).

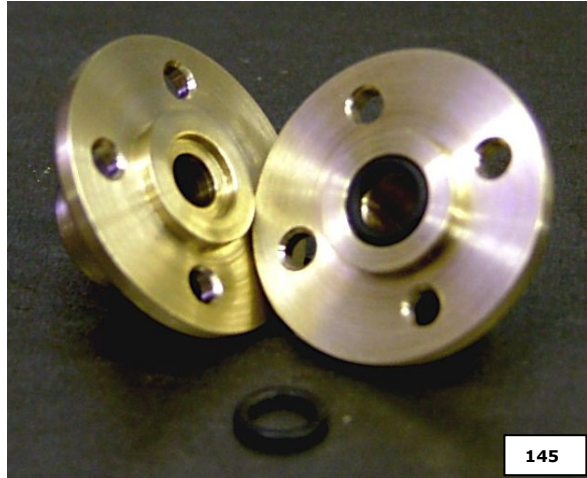

This o-ring stops steam leakage thru the control arm hole. The recess is bored 0.9mm deep (refer to Pic 145) to allow for an 0.1 mm crush on the o-ring.

This area can be machined to suit if you have o-rings of different sizes, but you must remember to alter the spindle size and the clamp hole size.

Anyway, back to the making and building; this is

done in stages to allow the correct fitting of parts.

The first bit to be made is the spool. Turn your bar down to fairly tight fit in the main bore of the block, for a length of about 30mm. Then turn down the 15mm long by 4mm spigot on the end. Part off the spool, leaving about 8.5mm length on the main spool. All shoulders on this spool valve need to be kept fairly sharp and square, so no heavy deburring.

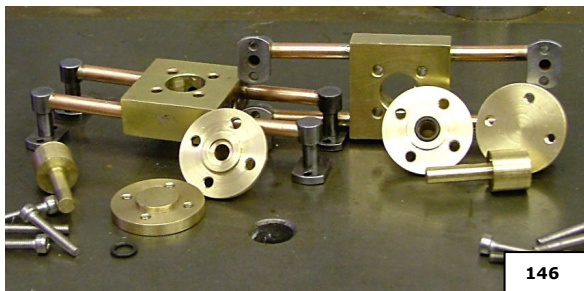

Pic 146 shows what the spool should look like, and it should be fairly tight in the bore.

Next hold the spool by the spigot of your chuck, and put a bit of metal polish, t-cut or chrome polish (raid the garage, you might find a very mild abrasive substance in there) and start up your lathe on the slowest speed possible.

“Bogstandard”: Building a Steam Engine from mainly Junk Materials  
Chapter 5

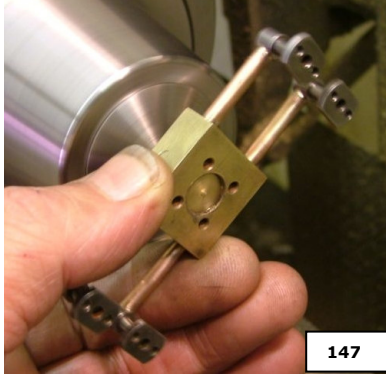

Refer to Pic 147. Being very careful about keeping your hands away from the chuck (I used my collet chuck because it is safer for me because I have to work left handed), gently feed the bore onto the rotating spool, get ready to let go just in case it galls up and starts spinning (galling is where the materials lock together; usually it is caused by the materials being the same or one is very soft).

If this happens, turn off the machine and try to unscrew the bits apart. If you can't, remove the lot from the chuck and gently tap apart using a piece of wood to protect the surfaces.

If all goes as planned the spool will go all the way thru the block, move the block up and down the spool a few times and it should feel nice and smooth and free. **Don't overdo it.** Take out of the chuck and give everything a very good clean; you don't want abrasive running around inside your new engine.

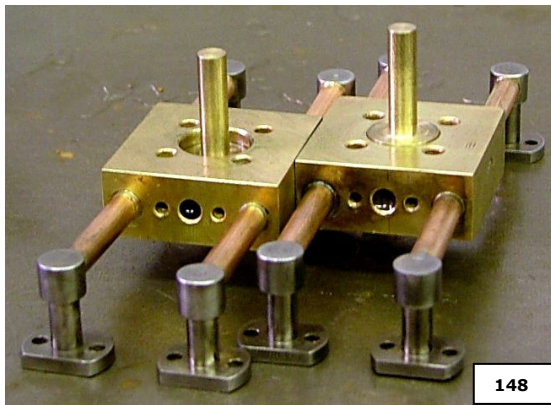

Put a bit of oil - I use multigrade or 3-in-1 (**Warning: on no account use WD40 anywhere near this engine; it ruins certain types of o-ring seals!**) and put the bits together and turn them. They should be silky smooth with no rock between the parts. If you've got rock, you've either been to the seaside or you have overlapped the parts. Make a new spool and start again! Don't worry about the bore; we make everything to fit that.

This takes you to Pic 148, showing the bits together.

Put the spool away safe for now and refer back to Picture 146 and sketch. We now make the top and bottom covers. Start with the bottom cover, remembering from the sketch that this has a thicker flange to allow for threading to 2.5mm. The spigot on it is machined for a good fit in the bore. The top cover is like the spool, done in stages to keep everything in line.

Turn the 7 mm spigot first and part off from your main bar. Remount in your chuck by holding onto the 7mm spigot. If you haven't already done it turn down the OD to 22mm. Now turn down the flange and the spigot for the bore.

Don't worry too much about the 1mm depth for the bore spigot; close enough is good enough - that goes for the bottom cover as well. As long as the total thickness of the flange and small spigot together add up to the total required on the drawing, all should be OK.

At this stage, bore your 4mm hole. Next cut your recess. If you are worried about getting a boring bar to do this, let me know and I will show you how to do the job with a throw-away one that only takes 10 minutes to make.

Now you have got your two covers. Pick up the holes from the main block and drill and tap all the holes. Then go and have a coffee and or a fag, cos the next bit is going to take ages.

Now you are refreshed and remember how I told you to make the 10mm diameter spool longer than required? Put the spool in the bore, pop the bottom cover on followed by the top (no need for o-ring until final assembly), no need for bolts yet.



“Bogstandard”: Building a Steam Engine from mainly Junk Materials  
Chapter 5

Hopefully the covers don't touch the faces of the main block! If they both touch, make a new spool - just a bit longer this time. Put the assembly on a flat surface, bottom down and push on the block; this will seat the bottom cover and raise the top cover away from the block. This is the amount we need to remove from the length of the spool.

Do a rough measure and remove a smaller amount from the bottom of the spool. Try fitting again. If it is getting close, just remove 0.02mm at a time, until you are very close. Put a couple of screws in the covers and see if it still turns (don't tighten down until the later stages). When you get very, very close, rather than turning any off, try emery on a flat piece of wood to just to remove minute amounts. Continue until you can just turn the spool with the screws tightened, with no up and down movement. It took me about twenty disassemblies to get them perfect. Now to hack out the slots in the spool

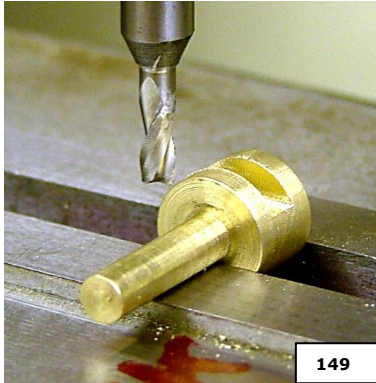

Refer to Pic 149. The slot is central on the spool depth. If you haven't got a 3mm cutter a 1/8" will suffice. Cut down to 3mm depth. Before you take out of the vice, scribe a line parallel to your cut across the face of the 4mm spigot; this is to show you where the control faces are after it is assembled in the block.

Now go to Pic 150. You have to mount the spool so your cut is parallel to the first one. I don't have a narrow enough parallel to sit inside the previously cut slot, so I improvised and used the blade on my engineers square. Machine the same position, size and depth of the first slot. Job nearly done.

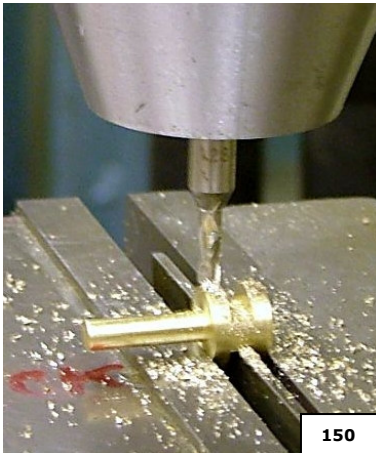

Only deburr by slight scraping of the edges. You will most probably find that it will now NOT fit into the bore, but just put a bit more metal polish on to the spool, and do a very gentle relap.

Clean down again and assemble, using some sealant on the face joints, but this time put the o-ring in. This will cause a slight bit of drag but nothing to worry about.

Make the control arm. Fit it so that it is at right angles to your scribed marks and you should have a non-leaking control valve.

All the bits for the assembly are shown in Pic 151.

Almost there, the last component for the engine.



"Bogstandard": Building a Steam Engine from mainly Junk Materials  
Chapter 5

**Lubricator**

I have made here a fairly large lubricator - should get a good session out of this.

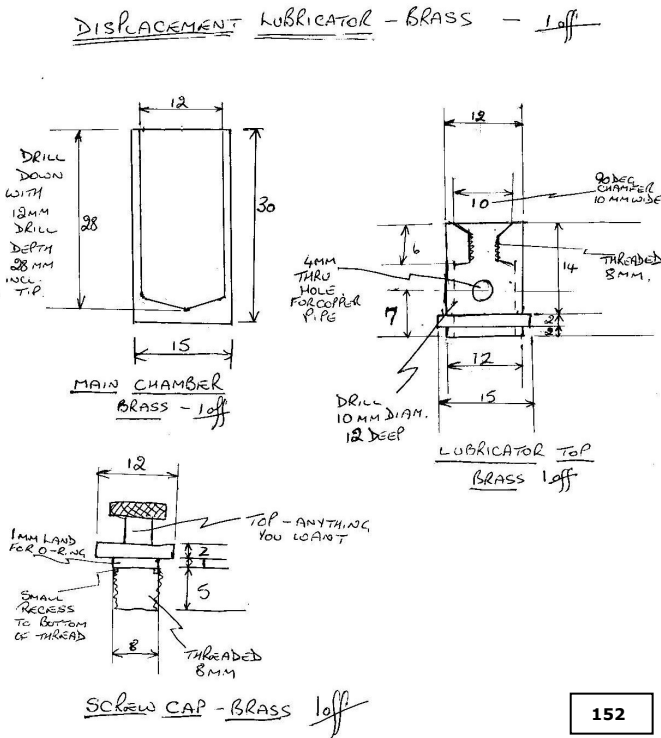

Three bits on the sketch (Pic 152); the fourth you have made previously - the longer of the two steam pipes.

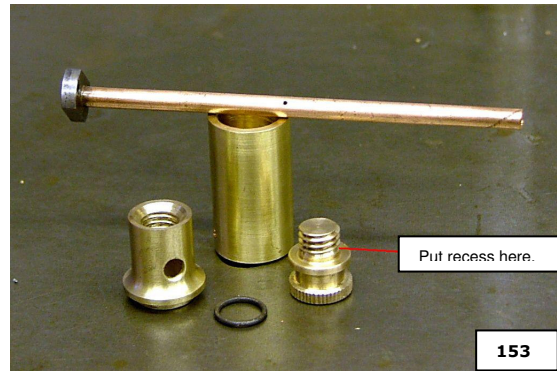

Pic 153 shows the three parts to be made, plus the long tube with a hole drilled half way along in line with the mounting bolt holes. The hole only goes in one side, mine is 0.7mm diameter, but you can use up to 1mm. If it under lubricates I can always open up the hole, but if it lets too much thru it is difficult to make smaller. The bit of text pointing to the cap is if the cap won't tighten down fully; just

put a small recess to the bottom of thread depth and that should cure it.

The o-ring is 8mm bore by 1mm cross section Viton (the same as the piston rings. The one shown here is in fact a used one from running in my oscillators; it is only worn on the outside edge so why pay another 47p for a new one. As I said before, nothing is thrown away until it can't be used any more.



Pic 154 shows the bits silver soldered up. I soldered up the chamber and top first, then put it in the lathe to be cleaned up, then I soldered in the copper pipe. When soldering this in, make sure that the flange is in the up/down position otherwise you will have trouble filling the lubricator, but not emptying it. I put the hole on mine facing up, so if it does get blocked it can be cleaned out.

**ONLY USE CORRECT STEAM OIL IN THIS LUBRICATOR.** For the rest of the engine, use almost anything **EXCEPT** steam oil or WD40. I use multigrade.

You might have to make a few extended tools to fit these two pipes correctly, but that is the price you pay for

having no bends.

I will try to get the timing sorted by days end, but no promises.