

CHAPTER 3

Eccentrics

I went into the workshop this morning hoping to finish off the crankwebs and shafts. Then a thought occurred to me: I hadn't even considered one of the major parts - THE DREADED ECCENTRIC! No, not me, but a little thing that puts the dread into making small steam engines. And they are so simple to produce if gone thru logically. I have already done a bit of preliminary design work on the piston valve block so I know what lift is required.

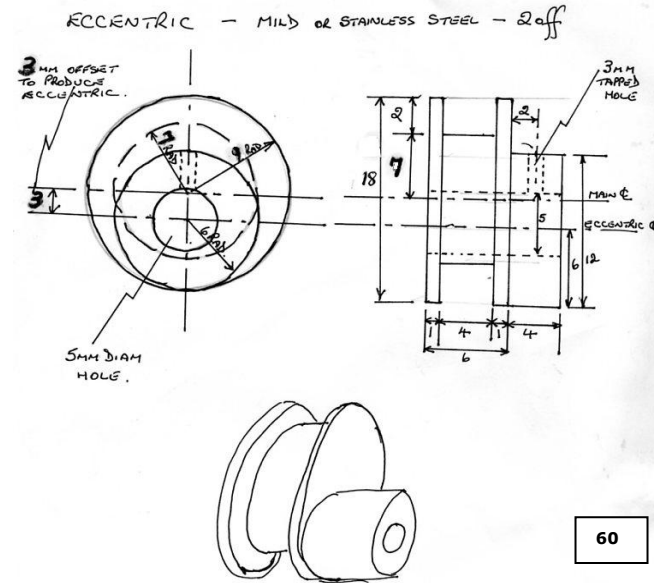

Study the sketch (Pic 60), a bit off-putting isn't it? We are going to split it down into easy parts.

Start by turning the bar down to 18mm and face the end; put the 4mm wide groove into it, 1mm from the end. Measure 10.5mm from the faced end and part off at this point. Repeat the procedure. Remount the cut-off piece into the chuck with the groove inside the jaws, Face up until you have a length of 10mm (no longer, if anything go slightly under), you should now have what is shown on Pic 61.



There are a few different ways to put the eccentric hole thru, but this one is bob on accurate. If you refer to Pic 62, it shows my bits of metal mounted in a chuck of a rotary table and a DTI running around the edge. I use this setup because it is easier for me with my slight infirmity. As I said before, if you are doing this with a vertical slide, imagine the DTI in your lathe chuck and the part to be drilled in your vertical slide vice. Basically what you have to do is centralize the workpiece to the chuck.

Once this is done, just offset the workpiece by 3mm using your crossslide or vertical slide, put the drill in the lathe chuck and drill thru. Eccentric conquered. You should end up with bits like shown in Pic 63. While I had the workpiece set up, I took the opportunity to mark the end with the groove to help with setting up the engine.

Remember a few posts back where we set up in the lathe for putting on the anti-friction bosses on the crankshaft blocks? Well the next operation is almost the same but a little more precise.

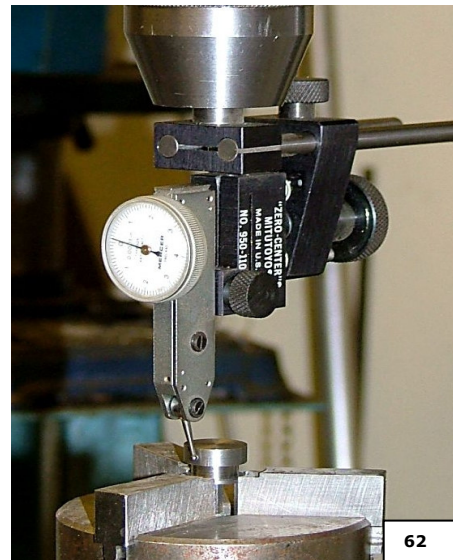

“Bogstandard”: Building a Steam Engine from mainly Junk Materials
Chapter 3

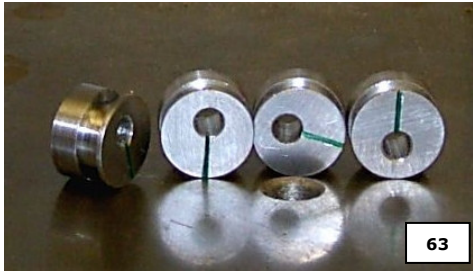

Take a piece of 5mm rod and mount it in the lathe and drill and tap the end 3mm. Move the rod back in the chuck until about 8mm is protruding and give it a good tighten. Slip on the eccentric with the groove towards the chuck and screw in a screw and washer to grip the part against the chuck jaws, see picture 64. By the way: the 4-jaw chuck I am using here is not a 4-jaw independent but a 4-jaw self centring, same as your 3-jaw but with four jaws; I find them a lot more accurate and more versatile.

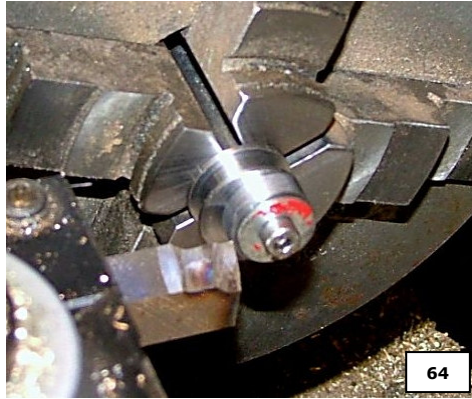

Now take very fine cuts (max 0.3mm) for a distance of 4mm along the workpiece. Keep taking fine cuts until a boss diameter of 12mm is reached (not critical).

Take off eccentric and drill and tap the 3mm hole at the position as marked on the sketch, it can be anywhere around the boss.

You should now have eccentrics that look like the ones in Pic 65. (Note: mine have yet to be drilled and tapped.)

Now wasn't that easy campers! Next week we will be making a 24-lobe camshaft for an aircraft engine.

That's it now until next week - I have some other work to do.



Hi there John, thanks to you (on CNC forum), I resolved the problem of drilling a series of tiny holes, using tiny (0.9mm) centre drills to spot first, worked a treat!. I got them from some polish guys who set up a market stall in a lay-by near my house here near Florence. I also got a nice 5" 4 jaw ind chuck new! And 10 bars, 8-10 mm round and square of good HSS, 10 of the centre drills all for 50 euros! (about £30), by the way the chuck fitted straight on the boss on my lathe! If you look on the new people section under engines on this forum I put up a photo of an engine I'm working on, you'll see that the heads on the cylinders have 4 holes around them, I did them, after some thought, hole by hole on the mill, but as Eddy suggested (but some time ago) all from the same piece, and then parted them off, as they are only 4mm or so thick I thought it would be ok, but the drill did wander a touch on one, luckily not enough to be seen with the pan head Allen screw in it, but still annoying! I have an idea for a v-twin overhead valve engine I'd like to make, maybe I'll start a thread!...thanks and well done on your engine and very well explained! I'm of the fag packet school like you (sometimes I don't even do a sketch! I'm too lazy!) I think these forums are great! Lets keep up the good work!...P.S. I'm with you on the fact that dogs can be a great help with these things sometimes, they have a more relaxed point of view!....

“Bogstandard”: Building a Steam Engine from mainly Junk Materials
Chapter 3

Support Columns

Managed to get top and bottom joined together, so I took a couple of Pics (67, 68) to show the development. The conrods are still not finished: the front one is what I expect it will look like; the rear is just the basic building block. And the thing still turns over, a bit tight, but that is easily remedied with a file and a hammer plus a bit of oil. I rushed these conrods so I think one of the holes isn't quite parallel, but as these are tryouts I am not worried.

Got the top and bottom joined with the right bits now.

First the sketch (Pic 66). This shows the dimension for the column length. As stated in a previous post about the thickness of plate used for the block support plate - this dimension is for a plate with a thickness of 2mm. If the plate you use is thicker, then subtract the difference from this length; if it is thinner, then add the difference to the length. If you don't do this you will end up with a mechanical lock on the engine. The columns can be any diameter from 6mm to 10mm, it doesn't matter, but if you use aluminium for the columns I would go for 8mm and above.

SKETCH FOR COLUMNS, LITTLE END PINS AND CONRODS

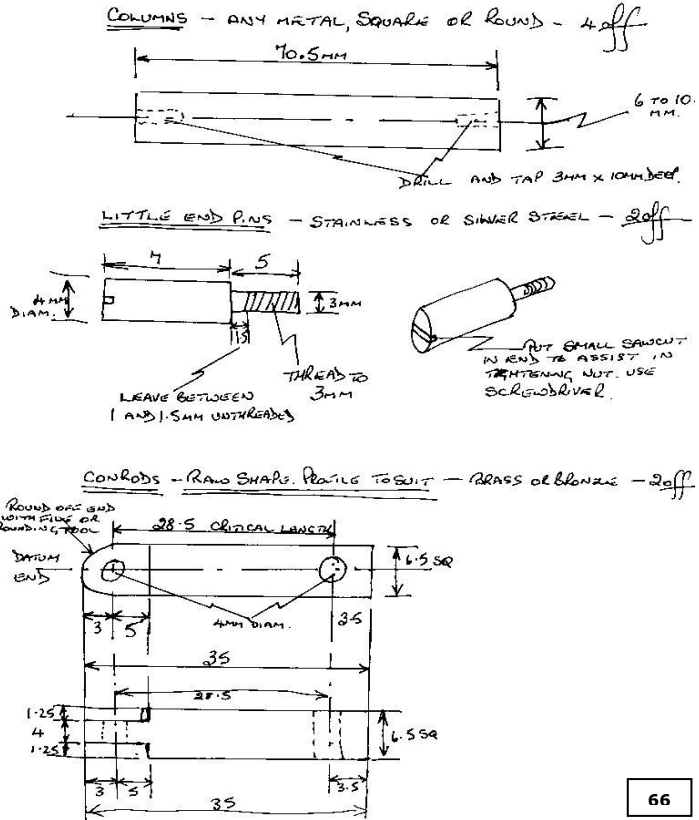

66

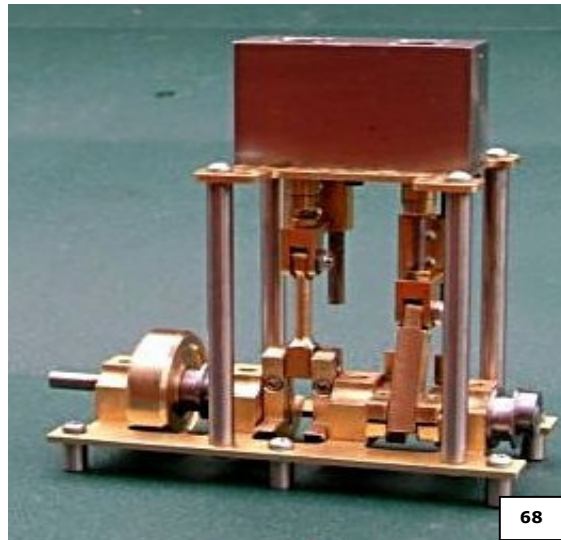
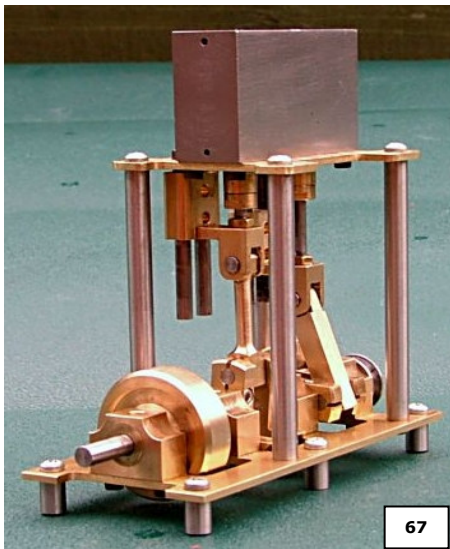

Conrods

The conrods are shown as a raw shape. The engine will run with them like this, but you can hack to your hearts content as long as you don't get too close to the bearing holes and don't reduce the diameter to less than 4.5mm. You can have it square or round; maybe profile it like a car conrod; drill holes thru them: it doesn't matter, let your imagination run wild. Also shown are the dimensions of the little end pins.

Picture 69 shows how I developed the conrods. Starting left to right: a bit of plasticard, just to see if I was in the ballpark, then a couple of rough ones - and I mean rough - made to check for correct length and dimensions. The next pair is the same except one was profiled to see what it would look like; these were correct dimensionally. The last are the finished rods and pins.

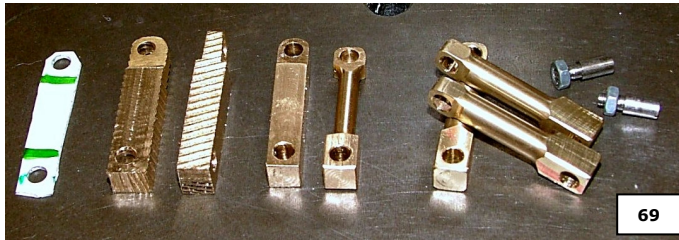

Picture 70 shows the engine with the new rods, I think it makes it look very beefy and powerful, what do you think? Also shown is a ruler against the engine, from the wrong angle, but it shows that the engine is about 4.5" high and it is the same length and 2" wide, not minute by any means but it should shove a boat of 4ft or over along quite easily. Sorry about that I have just reverted back to imperial, damn this government.

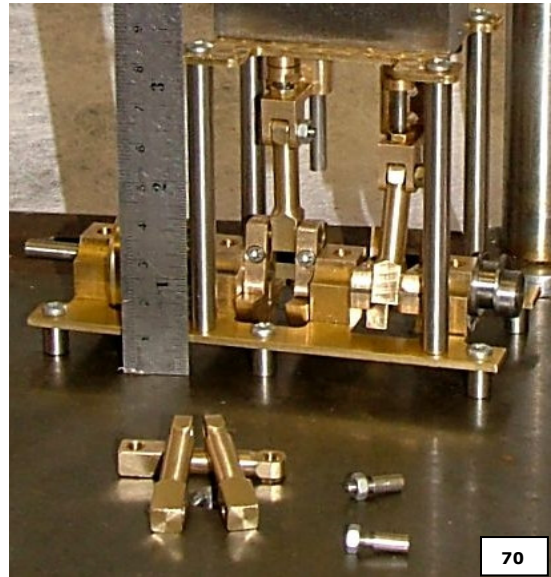

Question – What Speed/Reverse Control?

Now a question from me. Is anyone building this engine as I go along? Or as I suspect are you hanging round like vultures to see if I snuff it before I finish, or make one holy cock up of the whole thing so we end up with an engine that won't run. Oh! ye of little faith, this engine will be finished, even if the dog has to do it, and if it won't run I can always put an electric motor on it (hidden in a box behind the engine), so it looks like it runs.

Anyway, joking aside, I have a question to ask as to what type of speed control and reverse you want on this engine. Basically there are two that I will consider: the first is the usual type - that is, a rotating disc. These are easy to make except for the disc itself: they have to have fairly accurate transfer grooves machined on them and do require a rotary table, I know you can use straight transfer grooves, but I have never really found them satisfactory, also these controls tend to leak steam even though they are finely bedded in.

The second is a control block where everything is sealed inside and doesn't leak, but it does require the use of a small o-ring to seal the output shaft (I would consider supplying the o-ring if you sent an SAE. UK only), and the machining has to be fairly precise, but if you have got this far in the build you shouldn't have any trouble making it with the experience you have gained already.

The reason I have to ask is that I will be designing the piston valve area this next week and it all depends on which one is required determines where I should put the inlet/outlet flanges on the blocks. If you don't give feedback I will be going with the second option.

“Bogstandard”: Building a Steam Engine from mainly Junk Materials

Chapter 3

I won't be posting for about a week while I design the blocks and iron out any problems, but I will keep checking the site to see if there is any feedback. Last chance to vote is Wednesday evening.

I was doing a bit of design work tonight on the piston valve control block, and have decided to change the internal port sizes to allow for easier setting up. This means that the eccentrics will now have a different throw.

So the text for the post concerning the eccentrics has been changed and a modified sketch (051) has been uploaded.

If you have already made them as I have, at least you now know how easy it was, and they get easier the second time around.

Comment – Fourth Main Bearing

John, is there a reason for the fourth main bearing after the flywheel?

I think the engine would look a lot nicer without that bearing (personal preference), so I'm wondering if it's needed, or if it's just the way you do things?

The reason as Derek kindly pointed out is an engineering issue.

If the bearing between the crank and the eccentric on the flywheel end had been a lot longer and had a substantial support bearing in there then the fourth bearing could be omitted.

As it stands, the weight of the flywheel is trying to go downwards at an angle and will put a lot of wearing forces onto the bearing, so the fourth bearing ensures the downward moment of the flywheel is reduced, thus causing less wear.

Steam Chest Intro (Piston Valve Control Block)

I told you that this engine will be functional rather than pretty, but it will look a lot better when the steam chests go on.

Got on well today. Have got basic plans for steam chests and piston valve. A bit complicated because the block is so narrow, I couldn't use any internal porting, plus I needed to bolt the thing to the block so it took a fair time to get all the holes missing each other. I will knock up a couple of blocks tomorrow and see how it all fairs. In hindsight I would have made the blocks 10mm wider and gone for a 15mm bore, but one of the criteria was that I used as much material from the scrapyards as possible, and this was the largest block I could get out of the sash weights.

Have come across a major problem. As you know I was trying to keep this engine totally metric, but unfortunately my supplier doesn't stock 3mm copper tubing, so we will be using 1/8" instead. When I eventually put up the drawings, if you see any pipework or steam fittings mentioned on there, the relative holes will be marked in imperial with all other measurements in metric. If you only work in metric, 1/8" is equal to 3.2mm tight fit, or 3.3mm sloppy fit, so it would pay to invest in a 1/8" drill.

I have got to get on with this at the moment, so I am designing around a sealed control valve.

"Bogstandard": Building a Steam Engine from mainly Junk Materials
Chapter 3

Steam Chest – Part 1

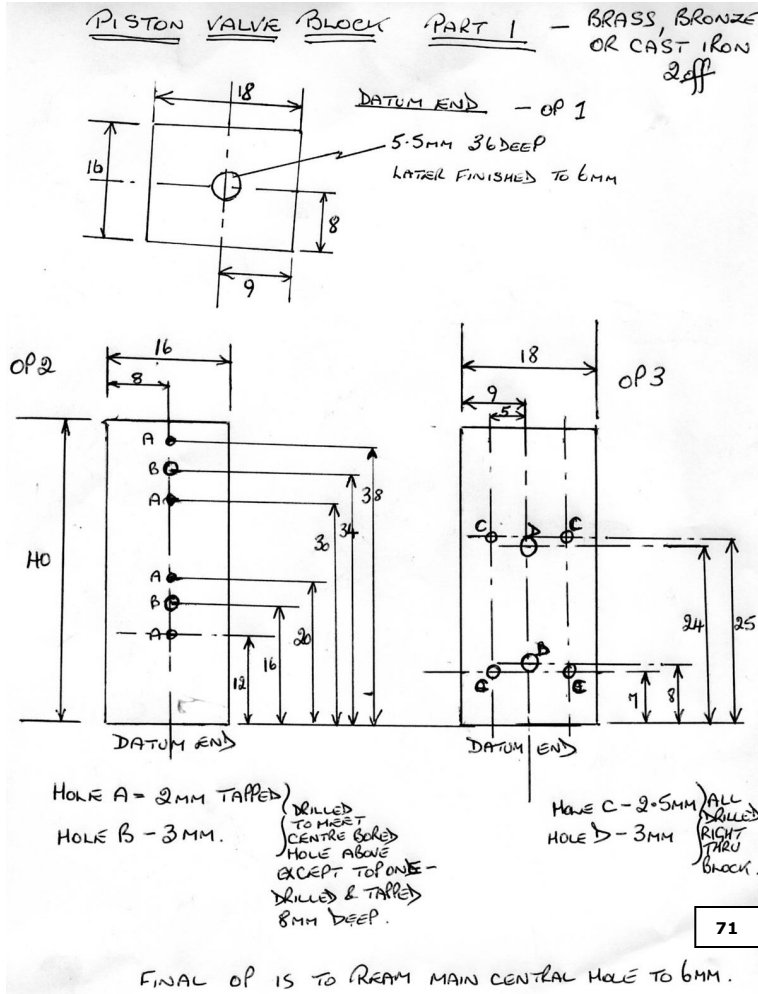

Managed to get it all designed, but all machining hasn't been done yet. The making of the piston valve control block will be done in two parts: the one here now gets all the holes in the right places; the next post will show what milling has to be done as the sketch would get very complicated if both were put onto the same one.

The sketch ([Pic 71](#)) shows all hole positions but they are drilled in a sequence – described below - to prevent burrs destroying the smooth cylinder walls.

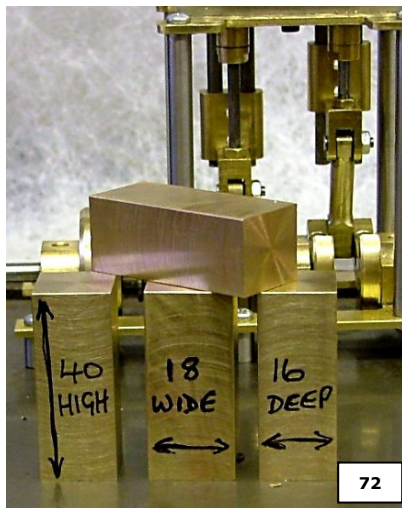

Pic 72 shows the correct size for blocks. Mark one small end and this will be your datum face.

The first op is to drill the 5.5mm hole as shown on the sketch small end, drill 36mm deep (including pointed drill end).

Second op: On the 16mm side you will see two 3mm holes and four tapped 2mm holes. These are all drilled thru to meet the 5.5mm centre hole all except the top one which is drilled 8mm deep. Tap the 2mm holes.

Third op: All the holes on the 18mm side are drilled all the way thru the block. The 3mm holes are the steam control holes and the centres between them need to be exact, so rather than marking out and drilling, use the machine feeds to get this spacing.

The four 2.5mm holes are for mounting the control valve to the main block (how this is mounted will be explained later).

“Bogstandard”: Building a Steam Engine from mainly Junk Materials
Chapter 3

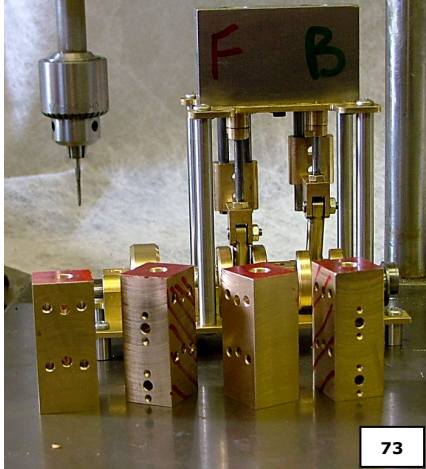

All holes should be deburred but the four ends of the steam control holes should only be deburred very lightly.

The final op is to run a 6mm reamer down the main central hole, this will clean off all the burrs thrown up on the inside and leave a nice clean hole for the piston rod to run in.

Don't worry about the 2mm tapped holes going into the bore, these will be sealed with a screw when the flanges are bolted on and the bit of tapped hole left on the inside should act like a reservoir to hold a bit of oil, and it makes them a lot easier to tap.

Pic 73 shows all the holes required on the block.

An aside: Remember a couple of posts back where we made the conrods and I said to use your imagination? Well Pic 74 shows the rods I have made for my second engine which is going to have a makeover as it is being built to try to spice up this utilitarian design.

You will notice that they are a different colour;; they are made from aluminium bronze, a lot lighter and stronger than brass. (Another choice product from the scrapyards, recognizing what it is while rummaging is the problem!)

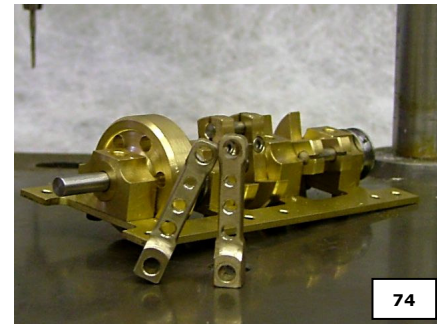

Steam Chest – Part 2

Now for the second part of machining the piston blocks.

Just a word of warning: you have to make an opposing pair, so mark everything up so you don't ruin your day.

The first part of the sketch (Pic 75) shows you the position of two slots you are going to mill out. They are to join the main piston valve ports to the ports on the main block that go to the top and bottom of the pistons.

I would suggest you bury the cat, superglue the dog in its basket, give the kids some money to go out and treat the wife to a girlie DVD: you do not want to be disturbed while machining these slots - go past the line and you are having a bad day, unless you are good at rebuilding with silver solder.

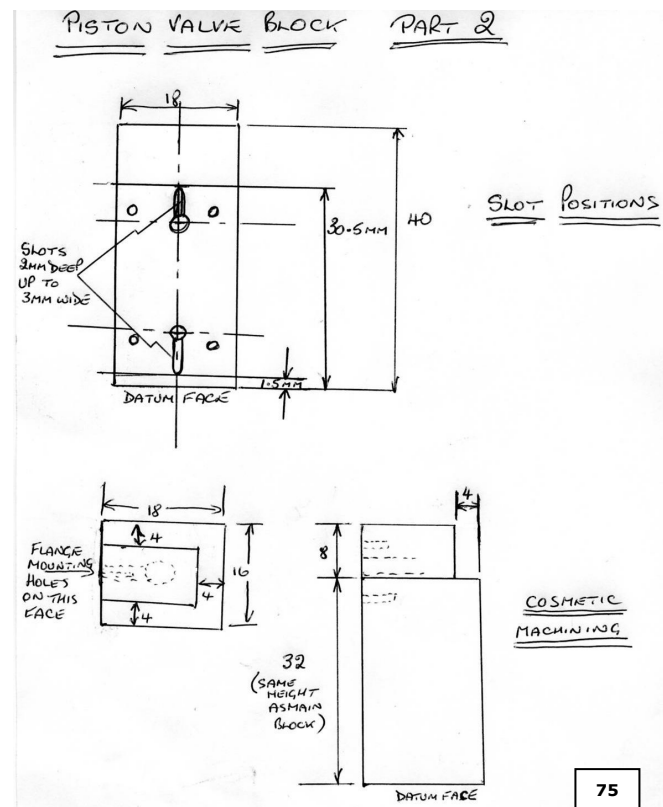

“Bogstandard”: Building a Steam Engine from mainly Junk Materials
Chapter 3

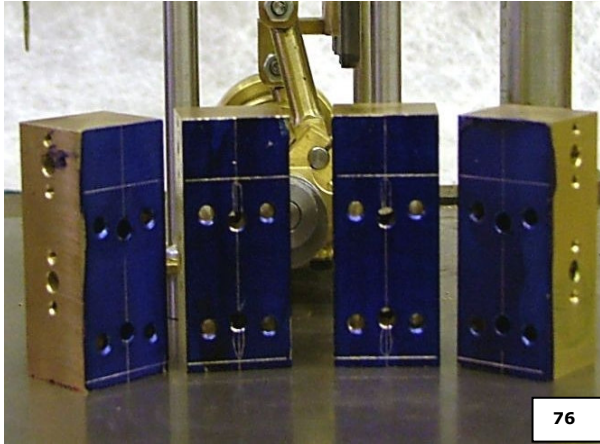

The slots should be 2mm deep and up to 3mm wide. I have made mine 2mm wide. If you look at Pic 76 it shows how I marked them up.

The lines are marked from the same datum as we used to drill all the holes in the previous post.

The top and bottom marked lines are absolute limits; do not go beyond them. I would stop about 0.2mm from the line.

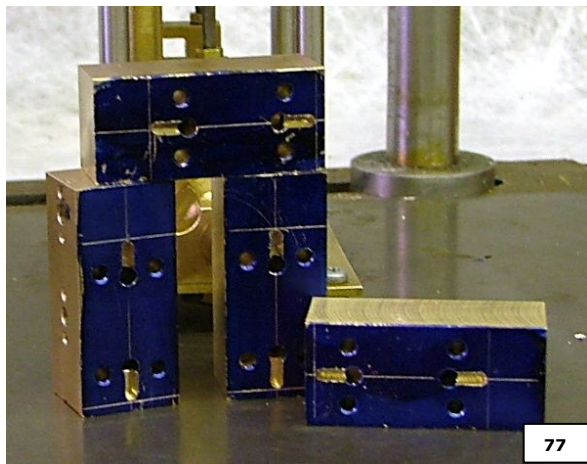

Once you have done one, mark up the second to give you an opposing pair and machine to the same criteria as the first. They should look like the ones in Pic 77.

Once you have your pair, now for a bit of cosmetic machining to make it look a lot better.

The second part of the sketch (Pic 75) shows what is to be hacked away.

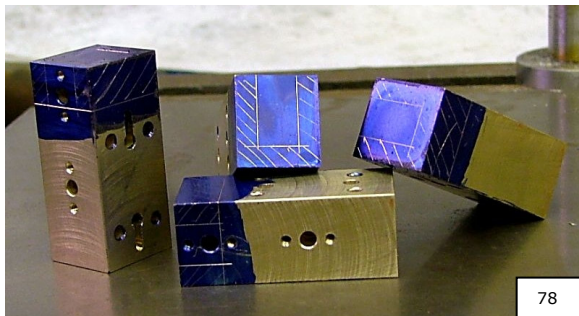

In Pic 78 it shows the hatched areas to be cut away. Nothing too critical but try to make the height the same as the main block just to keep it looking neat.

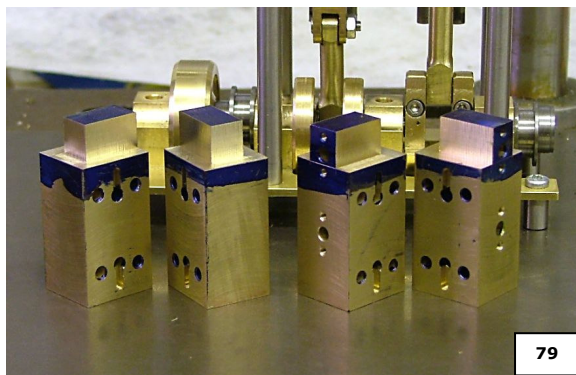

Pic 79 shows what you should end up with.

There is a bit more to do on this block but it is to do with a gland seal like we have on the main piston rods, but that can wait until later.

On the next one we should be able to get the block joined to the engine and make all the bits to connect to the eccentric. Once this is done we can get some air to it and time the lot in. After that it is just a matter of getting the pipework and control valve done, so we are fairly close now.

“Bogstandard”: Building a Steam Engine from mainly Junk Materials

Chapter 3

Just for D.....

Here is a little poser for you and your mates in Oz, seeing you spend more time looking into the background rather than at the piccies themselves.

You must have seen this little item (Pic 80) in the background of some of my pictures.

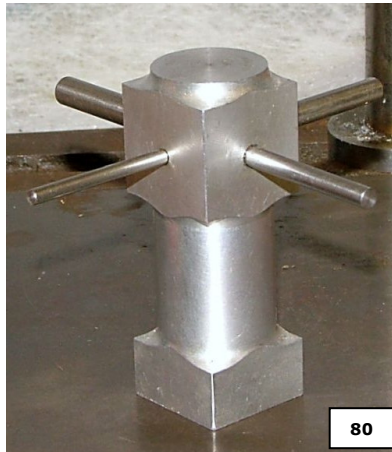

I designed this myself and it saves me hours of grief and stops those bad day blues.

It isn't going off topic because I use it all the time in making these engines. Usually a few times a day.

The four rods are a specific height from the base, and are sized 3,4,5 & 6mm.

It is used in conjunction with other pieces of equipment (I've most probably given the game away now).

I hope this will keep you occupied until I post again.

And it isn't a mini capstan for people with different sized hands.

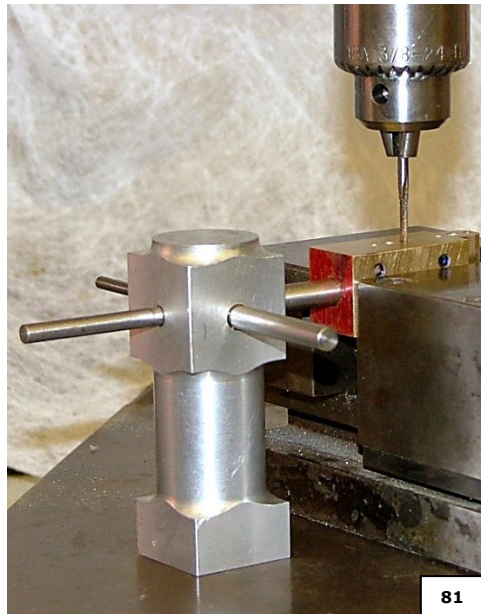

I thought you would get it straight away when you found the other picture with a square right next to it.

The solution is shown on Pic 81.

It is used to set up anything with a standard size hole (and even non-standard sometimes) into my toolmakers vice so that I can tap the hole using my vertical tapping stand perfectly square to the bore. It only takes seconds to do, and by the way, the jig is removed from the bore before tapping.

I have finished my commission jobs so I will be posting very soon.

“Bogstandard”: Building a Steam Engine from mainly Junk Materials
Chapter 3

Comment – Drilling Deep Holes - Introduction

John..... good to see you are progressing well with the engine design, I particularly like the way you have achieved the steam transfer passages.... certainly saves a lot of deep drilling and plugging of holes afterwards.

On the subject of deep holes: I attach some notes which may help any of you who may be following John's build, especially those who may be first time builders.

In no way should they be considered as any form of criticism of John's most excellent article, but merely as helpful tips towards getting the job done successfully, and with as few tears as possible.

As John has already stated, the purpose of his postings was to pass on the design as a whole, along with general processing methods, rather than a blow for blow account of how each piece was/should be made.

Having already mentioning the deep drilling issue in an earlier instalment, I felt it would be helpful/useful in this instance to enlarge a little upon the subject at this point.

There are, of course, many ways of achieving the deep hole required, these notes are just one possible method, and one which should be achievable by most of you.

“Bogstandard”: Building a Steam Engine from mainly Junk Materials
Chapter 3

Comment - Drilling the piston valve blocks

Just a few additional notes on the drilling of the main bore (6mm dia) on these blocks. It is essential that this bore is absolutely parallel with the face which mates with the cylinder block (the one with the small slots machined in it) and also the adjacent face containing the steam ports. In other words, the bore must be perfectly vertical to the engine centre line. It has already been mentioned (during the crankshaft web making instalment) about the tendency for the drill to wander off centre when drilling deep holes, and it is something to avoid wherever possible, especially with small drills. Here we have a case where it is unavoidable so I felt what follows would be interest/help to anyone perhaps building one of John's engines as a first project.

First off, do not try to drill these holes directly with a 5.5mm drill; this will inevitably end in disaster. After carefully centre drilling, start the bore drilling with a 2mm – 2.5mm dia drill and do not drill to deep in one go, but withdraw the drill every 1mm or so of depth to clear the swarf from the flutes.... Swarf build up is a major factors in diverting the drill from its correct path.... Continue drilling until the bore is say 32mm – 33mm deep.

Next change the drill for say a 4mm – 4.5mm dia, and repeat the drilling to the same depth, again withdrawing repeatedly to remove the swarf. Repeat the above with a 5.2 – 5.3mm drill, but, this time, take it down to the full 36mm depth (including the length of the drill point). Keep a close eye on the drill during this pass, and it will be obvious if the drill is trying to wander (it will appear to wiggle in the bore). If this occurs, stop drilling.

To remedy this situation, it will be necessary to use a small boring tool (yes they do exist) to continue further. (See below).

*Providing the drilled hole remains true, then use successively larger drills to open out the bore to **5.9mm dia**.*

Why 5.9mm, when John says 5.5mm?

This is to do with the final reaming of the bore..... a reamer should only be used to remove the last 0.1mm, or less, from the bore... they are not really designed to take relatively heavy cuts..... and the 0.5mm which would be left after the 5.5mm drill is, in my opinion, to heavy, especially if you are using a small, light, lathe. In this case, attempting such a heavy cut could result in overloading the machine, possibly damaging the drive gears (which are often plastic on small machines) and may even result in the reamer jamming in the workpiece.

Worse still, the reamer could easily shatter due to the applied torque.... Not good for the job, or the wallet..... good quality reamers are not the cheapest of tools. I am sure John will agree with me on this score.

A final word about reamers..... for this job you will need to use a MACHINE REAMER; not the more usual hand reamer.

The more generally purchased hand reamer, whilst absolutely fine for reaming holes through small pieces where the hole goes right through, and is of short length relative to the length of the reamer, such as big end bores or bearing blocks, they are not suitable for this job which is a deep BLIND hole.

To explain..... Hand reamers are designed with a slight taper on the leading edge; often extending perhaps 25% of the total reamer length, whereas, MACHINE REAMERS are parallel for their whole length. If a hand reamer were to be used for this bore, then the piston valve bobbin (John's next component) would jam in the resulting bore. The other thing to watch here is the type of end on the reamer..... some have quite a long pointed end (like the point of a drill, but often longer) if this is the case then this will need to be ground off (leaving just a very small lead in...0.5mm or so) otherwise the reamer will not get to the bottom of the bore.

“Bogstandard”: Building a Steam Engine from mainly Junk Materials
Chapter 3

Comment - Small Boring Tool

If the need arises, due to drill wander, to resort to correction with a boring tool then don't panic.... These are available from sources such as Arc Euro Trading, who can supply small solid carbide boring tools down to 2mm dia.

Alternatively, one can be ground from tool steel, if you don't feel you have the ability to do this, then perhaps a word with a friendly engineering workshop would be of help. The method employed should be to take very light cuts, gradually opening the hole dia, until the bore runs true..... continue boring until the next largest drill, to the one you were last using, just fits the bore..... you can then return to using this drill size for the remaining depth. These small boring tools do, unfortunately, have a maximum boring depth associated with them, typically 15mm – 16mm for the 4mm dia tool, however this would be more than deep enough to guide the drill.

Comment – Deep Hole Drilling - General notes

*A final point regarding this matter.... Deep hole drilling is, as I am sure John will agree, a tricky subject, and many tomes have been written on the subject, however, often the cause of the wandering is the drill bit being used. It is essential that the drill be sharpened correctly, i.e., it's cutting edges must be absolutely of equal length, and of equal angle. Do not think for one minute that a brand new drill will be accurate.... They should be, of course, but I have yet to come across very many that are..... in most cases they would need some correction. The other thing that is helpful is to use what are known as STUB DRILLS.... These are considerably shorter than the more usual twist drill, and are very much stiffer, hence less likely to wander off the true path due to bending action often the result of applying to much drilling pressure. If you are planning on making more engines in the future, then it could be a wise investment to obtain a set of these in your more used sizes. The same consideration regarding correct sharpening still applies though.
Happy Drilling/Boring. Sandy*

Response – Deep Hole Drilling

I would like to thank Sandy for the post on deep hole drilling, very informative for everyone. My problem is that I have all the correct tooling and machines to carry out all the machining with ease and I keep forgetting that novices will not have access to the type of equipment that I possess, like most of my drills are precision four facet ground, plus I also have a set of metric drills specifically for drilling brass where the front face has been ground vertical to give a zero rake. To buy all these items at the beginning would cost a fortune, so purchase the best you can afford, you will find they will last a lifetime if correctly looked after. Most of my machine reamers came from the scrap man, who also clears out industrial workshops, and bought by the kilo. The last lot I bought were all brand new small metric (smaller than 10mm), solid carbide. I paid £20 and got about 25 reamers. The cost for one would be at least double this from a tool specialist. So if you really want to it can be done on a tight budget, you have just got to search about a bit. Many thanks again Sandy for your input.

Steam Chest Blanking Plate

Now we are cooking on gas. Starting to get it looking like a finished engine. There is no need for a sketch for this post as it is done with pictures and superglue.

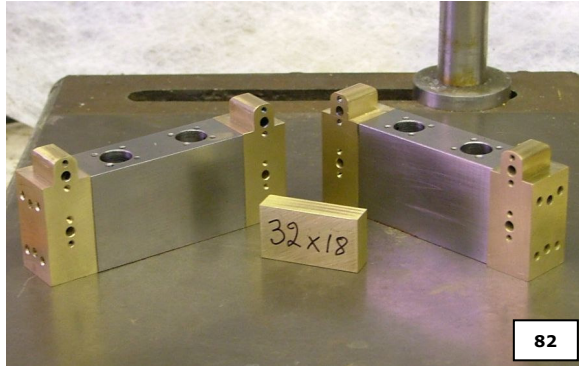

Pic 82 shows the size of the blanking plate for the end of the piston valve block; mine are made from the same material I used for the block support plate - 2mm thick brass - but I suppose they can be made of steel or AL. Just don't go too thin, as they are blanking plates for the steam control ports. I stuck mine together with double sided tape to allow me to machine all of them in one hit. You will only require two if you are making one engine but twelve if you make six (confusing isn't it).

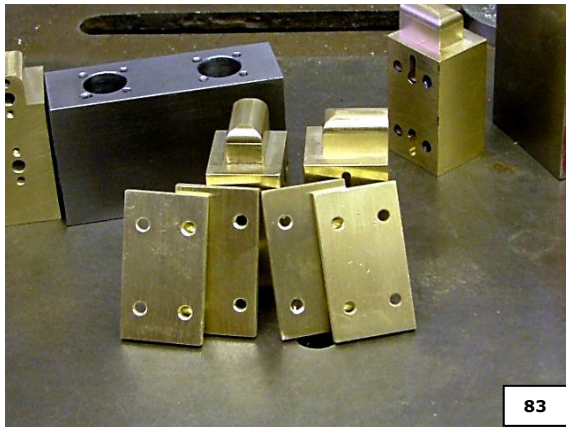

Once you have the plates made, carefully superglue them to one side of the piston valve block and spot thru the block mounting holes with a 2.5 drill; this will give you the marks to drill all the way through the plates, you should end up with plates as in Pic 83.

This time stick the blocks to the main piston block (the big shiny one) - too many pistons in this game, I'm going home - and carry out the same manoeuvre by spotting thru with a 2.5mm drill. This again will give you your drill marks. Drill these holes with a 2mm drill 7mm deep and tap to 2.5mm.

thread, rather than drilling 4mm deep and having to use both taper and plug tap. At my age time is precious.

By the way, the reason I always drill and tap so deep is that I am lazy. By drilling so deep it allows me to use a taper tap and get about 4mm depth of good thread, rather than drilling 4mm deep and having to use both taper and plug tap. At my age time is precious.

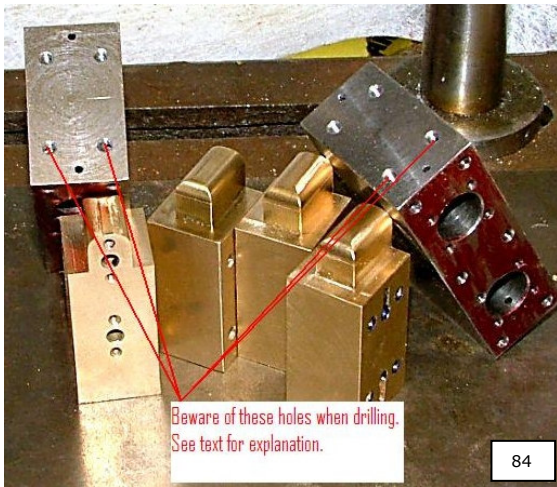

***** **WARNING** *****

Look at picture 84 and you will see the lower holes marked as a danger area. The reason for this is that when you drill these four holes they will penetrate the remnants of the holes that were drilled for the plate mounting screws, so unless you want to keep the DIY stores in business by selling you 2mm drills, take it VERY slowly and steady after you have penetrated about 2mm.

I will post a sketch tomorrow for all the hole locations if you do not want to spot thru. The reason for this is a fellow member of PD's has kindly offered to draw up the plans for this engine, and this sketch will be needed. So hopefully after the end I should be able to upload a good version rather than all my grotty sketches.

“Bogstandard”: Building a Steam Engine from mainly Junk Materials
Chapter 3

Back to the build. Now you should have two plates drilled and deburred, and one main block with four holes extra in each end - that is eight all together. Any less and you need to check again; any more and you are in trouble.

We now need to join all the bits together, so I thought I would give you a choice. One is rather expensive; the other is dirt cheap - if you know any stainless steel welders. The first option is to buy some long 2.5mm bolts (I bought mine on a visit to Germany many years ago) and use those.

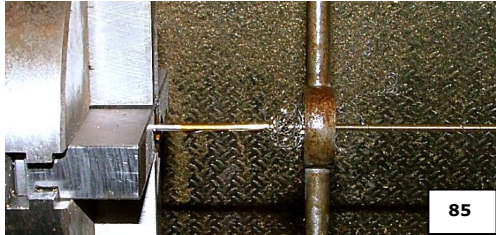

The second option is to use 2.5mm studding. I made these yesterday (Sunday), and I thought to myself 'Where can I get 2.5mm stainless studding on a Sunday?' In fact, where can I get it period! Then it occurred to me that a friend had given me some stainless welding rod a while back.

I measured it up and it came out to 2.37mm or near enough for what we want. I needed about 350mm of the stuff. So I lathe into very slow back gear, out with the die stock and die, and having about 75mm sticking out of the chuck at a time with plenty of cutting compound, within 10 minutes had what was needed (miles quicker than making individual studs with a thread at each end). See Pic 85.



I cut these into 26mm lengths and joined all the bits together, see Pics 86 & 87. I am lucky, because I am building two engines I can have both, but I suppose you could mix and match if you were that desperate.

(a bit of high precision turning), but by now these will be a piece of cake with all the experience you have had so far.

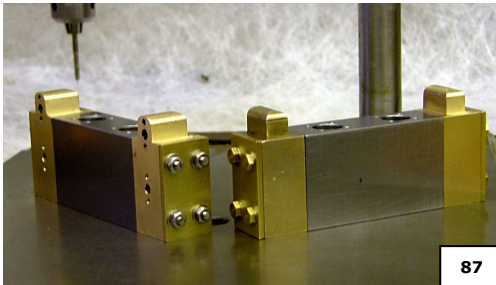

These might take a couple of days for me to make and draw up so don't hold your breath.

Response – Deep Drilling, Tooling Availability

I would like to thank S... for the post on deep hole drilling, very informative for everyone. My problem is that I have all the correct tooling and machines to carry out all the machining with ease and I keep forgetting that novices will not have access to the type of equipment that I possess, like most of my drills are precision four facet ground, plus I also have a set of metric drills specifically for drilling brass where the front face has been ground vertical to give a zero rake. To buy all these items at the beginning would cost a fortune, so purchase the best you can afford, you will find they will last a lifetime if correctly looked after.

Most of my machine reamers came from the scrap man, who also clears out industrial workshops, and bought by the kilo. the last lot I bought were all brand new small metric (smaller than 10mm), solid carbide. I paid £20 and got about 25 reamers. The cost for one would be at least double this from a tool

“Bogstandard”: Building a Steam Engine from mainly Junk Materials
Chapter 3

specialist. So if you really want to it can be done on a tight budget, you have just got to search about a bit. Many thanks again Sandy for your input.

Comment – Tapping Holes

No problem John, I had a feeling you would see where I was coming from.

Like yourself, I am surrounded by similar large equipment and have many options/methods available to me in achieving a particular end.

I also tend to sometimes forget that others are not necessarily so well equipped and might find a particular process, second nature to us, quite daunting, especially when the main machines available may be a small lathe and a small bench drill. It was for such people that the added notes were intended.

On the subject of tapping holes, I use a slightly different approach, but for much the same reasons, I am also lazy, getting old and time is precious, so, like you, changing from taper tap to plug tap is not on.... I use spiral fluted taps, which are magic for blind holes and only one type is needed, namely the plug equivalent, which will tap a full thread right to the hole bottom.

The other advantage of these is that they throw the swarf out of the hole as it tends to climb up the spiral flute rather than falling to the bottom of the hole.

A small point on the availability, or not, of 2.5mm bolts, especially in the UK..... substitute with 7BA (use a 2.05mm tapping drill followed by a 7BA tap) which are readily available in hex headed form, even in stainless steel, from many of the model engineering suppliers.

Ok that's my lot. S....

Response – Helicoils, Spool Valves

Little would you believe it I have loads of the spiral flute taps, exactly as you said. But my problem in the frantic rush at the scrapman's emporium when a new load of tooling came in and I saw all the small metric sizes I snatched his hand off fairly quickly. Anyway a couple of weeks later I came to use one of the taps and just looked to see what size it was and noticed the word HELICOIL on the side. Never used them yet, but did manage to get a load of inserts just in case.

By the way, the design I will be using for the 'bobbin' valve (I would in fact call it a spool valve, from my days in pneumatics) is the one you told me about, being drilled from one end with an outlet hole just below the lower spool. I have the machining sequence already tried out and seems to work ok, can be tackled easily by anyone and should produce a good valve. Thanks for the design idea, it has saved me hours working out porting to get from top to bottom.

Sorry if this post has baffled anyone, just a quick explanation on the word helicoil. Helicoils are usually a steel thread insert put in to either repair or make more hard wearing a tapped hole. The taps are marked up as say 3mm, but in fact they cut a lot larger to allow the insert to be fitted to bring the hole back to 3mm size. So the ones I bought were no use for tapping standard size holes - DOH!!
Now you see the reason for my signature.

“Bogstandard”: Building a Steam Engine from mainly Junk Materials
Chapter 3

Comment – Cutting Fluids

*For aluminium a small drip of kerosene only, for aluminium bronze we couldn't afford anything, for red brass...one little drop of **RocoiYel**, for steel....one little dollop of that **green slime TREiFolEX**.*

I will just answer D's question first.

When tapping I tend to use Rocol cutting compound for almost anything except for cast iron which I always cut with no lubricant at all. Machining metal is a totally different process, and as you said, paraffin for ally, standard water soluble cutting oil for almost everything else.

BTW for cutting copper (one of the worst materials to try to machine, it is like trying to machine evostik glue) try cow's milk as a lubricant (if you can get the cow past the wife without her noticing). I suppose Derek could use his famous Ozzie goatsmilk, but I think the smell would be a bit off-putting.

BTW I see you rise late in Oz. By 6am I have done the 3 Sh's, walked the dog about a mile and sat down to Weetabix, coffee and a fag, in that order. Then it's usually time to read the new posts.