



GE Fanuc Automation

Computer Numerical Control Products

*Series 16i / 18i / 160i / 180i – Model A
for Machining Center*

Operator's Manual

GFZ-63014EN/01

March 1997

Warnings, Cautions, and Notes as Used in this Publication

Warning

Warning notices are used in this publication to emphasize that hazardous voltages, currents, temperatures, or other conditions that could cause personal injury exist in this equipment or may be associated with its use.

In situations where inattention could cause either personal injury or damage to equipment, a Warning notice is used.

Caution

Caution notices are used where equipment might be damaged if care is not taken.

Note

Notes merely call attention to information that is especially significant to understanding and operating the equipment.

This document is based on information available at the time of its publication. While efforts have been made to be accurate, the information contained herein does not purport to cover all details or variations in hardware or software, nor to provide for every possible contingency in connection with installation, operation, or maintenance. Features may be described herein which are not present in all hardware and software systems. GE Fanuc Automation assumes no obligation of notice to holders of this document with respect to changes subsequently made.

GE Fanuc Automation makes no representation or warranty, expressed, implied, or statutory with respect to, and assumes no responsibility for the accuracy, completeness, sufficiency, or usefulness of the information contained herein. No warranties of merchantability or fitness for purpose shall apply.

SAFETY PRECAUTIONS

This section describes the safety precautions related to the use of CNC units. It is essential that these precautions be observed by users to ensure the safe operation of machines equipped with a CNC unit (all descriptions in this section assume this configuration). Note that some precautions are related only to specific functions, and thus may not be applicable to certain CNC units.

Users must also observe the safety precautions related to the machine, as described in the relevant manual supplied by the machine tool builder. Before attempting to operate the machine or create a program to control the operation of the machine, the operator must become fully familiar with the contents of this manual and relevant manual supplied by the machine tool builder.

Contents

1. DEFINITION OF WARNING, CAUTION, AND NOTE	s-2
2. GENERAL WARNINGS AND CAUTIONS	s-3
3. WARNINGS AND CAUTIONS RELATED TO PROGRAMMING	s-5
4. WARNINGS AND CAUTIONS RELATED TO HANDLING	s-7
5. WARNINGS RELATED TO DAILY MAINTENANCE	s-9

1

DEFINITION OF WARNING, CAUTION, AND NOTE

This manual includes safety precautions for protecting the user and preventing damage to the machine. Precautions are classified into Warning and Caution according to their bearing on safety. Also, supplementary information is described as a Note. Read the Warning, Caution, and Note thoroughly before attempting to use the machine.

WARNING

Applied when there is a danger of the user being injured or when there is a damage of both the user being injured and the equipment being damaged if the approved procedure is not observed.

CAUTION

Applied when there is a danger of the equipment being damaged, if the approved procedure is not observed.

NOTE

The Note is used to indicate supplementary information other than Warning and Caution.

- **Read this manual carefully, and store it in a safe place.**

2 GENERAL WARNINGS AND CAUTIONS

WARNING

1. Never attempt to machine a workpiece without first checking the operation of the machine. Before starting a production run, ensure that the machine is operating correctly by performing a trial run using, for example, the single block, feedrate override, or machine lock function or by operating the machine with neither a tool nor workpiece mounted. Failure to confirm the correct operation of the machine may result in the machine behaving unexpectedly, possibly causing damage to the workpiece and/or machine itself, or injury to the user.
2. Before operating the machine, thoroughly check the entered data. Operating the machine with incorrectly specified data may result in the machine behaving unexpectedly, possibly causing damage to the workpiece and/or machine itself, or injury to the user.
3. Ensure that the specified feedrate is appropriate for the intended operation. Generally, for each machine, there is a maximum allowable feedrate. The appropriate feedrate varies with the intended operation. Refer to the manual provided with the machine to determine the maximum allowable feedrate. If a machine is run at other than the correct speed, it may behave unexpectedly, possibly causing damage to the workpiece and/or machine itself, or injury to the user.
4. When using a tool compensation function, thoroughly check the direction and amount of compensation. Operating the machine with incorrectly specified data may result in the machine behaving unexpectedly, possibly causing damage to the workpiece and/or machine itself, or injury to the user.
5. The parameters for the CNC and PMC are factory-set. Usually, there is not need to change them. When, however, there is not alternative other than to change a parameter, ensure that you fully understand the function of the parameter before making any change. Failure to set a parameter correctly may result in the machine behaving unexpectedly, possibly causing damage to the workpiece and/or machine itself, or injury to the user.
6. Immediately after switching on the power, do not touch any of the keys on the MDI panel until the position display or alarm screen appears on the CNC unit. Some of the keys on the MDI panel are dedicated to maintenance or other special operations. Pressing any of these keys may place the CNC unit in other than its normal state. Starting the machine in this state may cause it to behave unexpectedly.
7. The operator's manual and programming manual supplied with a CNC unit provide an overall description of the machine's functions, including any optional functions. Note that the optional functions will vary from one machine model to another. Therefore, some functions described in the manuals may not actually be available for a particular model. Check the specification of the machine if in doubt.

WARNING

8. Some functions may have been implemented at the request of the machine-tool builder. When using such functions, refer to the manual supplied by the machine-tool builder for details of their use and any related cautions.

NOTE

Programs, parameters, and macro variables are stored in nonvolatile memory in the CNC unit. Usually, they are retained even if the power is turned off. Such data may be deleted inadvertently, however, or it may prove necessary to delete all data from nonvolatile memory as part of error recovery.

To guard against the occurrence of the above, and assure quick restoration of deleted data, backup all vital data, and keep the backup copy in a safe place.

3

WARNINGS AND CAUTIONS RELATED TO PROGRAMMING

This section covers the major safety precautions related to programming. Before attempting to perform programming, read the supplied operator's manual and programming manual carefully such that you are fully familiar with their contents.

WARNING

1. Coordinate system setting

If a coordinate system is established incorrectly, the machine may behave unexpectedly as a result of the program issuing an otherwise valid move command.

Such an unexpected operation may damage the tool, the machine itself, the workpiece, or cause injury to the user.

2. Positioning by nonlinear interpolation

When performing positioning by nonlinear interpolation (positioning by nonlinear movement between the start and end points), the tool path must be carefully confirmed before performing programming.

Positioning involves rapid traverse. If the tool collides with the workpiece, it may damage the tool, the machine itself, the workpiece, or cause injury to the user.

3. Function involving a rotation axis

When programming polar coordinate interpolation or normal-direction (perpendicular) control, pay careful attention to the speed of the rotation axis. Incorrect programming may result in the rotation axis speed becoming excessively high, such that centrifugal force causes the chuck to lose its grip on the workpiece if the latter is not mounted securely.

Such mishap is likely to damage the tool, the machine itself, the workpiece, or cause injury to the user.

4. Inch/metric conversion

Switching between inch and metric inputs does not convert the measurement units of data such as the workpiece origin offset, parameter, and current position. Before starting the machine, therefore, determine which measurement units are being used. Attempting to perform an operation with invalid data specified may damage the tool, the machine itself, the workpiece, or cause injury to the user.

5. Constant surface speed control

When an axis subject to constant surface speed control approaches the origin of the workpiece coordinate system, the spindle speed may become excessively high. Therefore, it is necessary to specify a maximum allowable speed. Specifying the maximum allowable speed incorrectly may damage the tool, the machine itself, the workpiece, or cause injury to the user.

WARNING**6. Stroke check**

After switching on the power, perform a manual reference position return as required. Stroke check is not possible before manual reference position return is performed. Note that when stroke check is disabled, an alarm is not issued even if a stroke limit is exceeded, possibly damaging the tool, the machine itself, the workpiece, or causing injury to the user.

7. Tool post interference check

A tool post interference check is performed based on the tool data specified during automatic operation. If the tool specification does not match the tool actually being used, the interference check cannot be made correctly, possibly damaging the tool or the machine itself, or causing injury to the user.

After switching on the power, or after selecting a tool post manually, always start automatic operation and specify the tool number of the tool to be used.

8. Absolute/incremental mode

If a program created with absolute values is run in incremental mode, or vice versa, the machine may behave unexpectedly.

9. Plane selection

If an incorrect plane is specified for circular interpolation, helical interpolation, or a canned cycle, the machine may behave unexpectedly. Refer to the descriptions of the respective functions for details.

10. Torque limit skip

Before attempting a torque limit skip, apply the torque limit. If a torque limit skip is specified without the torque limit actually being applied, a move command will be executed without performing a skip.

11. Programmable mirror image

Note that programmed operations vary considerably when a programmable mirror image is enabled.

12. Compensation function

If a command based on the machine coordinate system or a reference position return command is issued in compensation function mode, compensation is temporarily canceled, resulting in the unexpected behavior of the machine.

Before issuing any of the above commands, therefore, always cancel compensation function mode.

4

WARNINGS AND CAUTIONS RELATED TO HANDLING

This section presents safety precautions related to the handling of machine tools. Before attempting to operate your machine, read the supplied operator's manual and programming manual carefully, such that you are fully familiar with their contents.

WARNING

1. Manual operation

When operating the machine manually, determine the current position of the tool and workpiece, and ensure that the movement axis, direction, and feedrate have been specified correctly. Incorrect operation of the machine may damage the tool, the machine itself, the workpiece, or cause injury to the operator.

2. Manual reference position return

After switching on the power, perform manual reference position return as required. If the machine is operated without first performing manual reference position return, it may behave unexpectedly. Stroke check is not possible before manual reference position return is performed. An unexpected operation of the machine may damage the tool, the machine itself, the workpiece, or cause injury to the user.

3. Manual numeric command

When issuing a manual numeric command, determine the current position of the tool and workpiece, and ensure that the movement axis, direction, and command have been specified correctly, and that the entered values are valid.

Attempting to operate the machine with an invalid command specified may damage the tool, the machine itself, the workpiece, or cause injury to the operator.

4. Manual handle feed

In manual handle feed, rotating the handle with a large scale factor, such as 100, applied causes the tool and table to move rapidly. Careless handling may damage the tool and/or machine, or cause injury to the user.

5. Disabled override

If override is disabled (according to the specification in a macro variable) during threading, rigid tapping, or other tapping, the speed cannot be predicted, possibly damaging the tool, the machine itself, the workpiece, or causing injury to the operator.

6. Origin/preset operation

Basically, never attempt an origin/preset operation when the machine is operating under the control of a program. Otherwise, the machine may behave unexpectedly, possibly damaging the tool, the machine itself, the tool, or causing injury to the user.

WARNING**7. Workpiece coordinate system shift**

Manual intervention, machine lock, or mirror imaging may shift the workpiece coordinate system. Before attempting to operate the machine under the control of a program, confirm the coordinate system carefully.

If the machine is operated under the control of a program without making allowances for any shift in the workpiece coordinate system, the machine may behave unexpectedly, possibly damaging the tool, the machine itself, the workpiece, or causing injury to the operator.

8. Software operator's panel and menu switches

Using the software operator's panel and menu switches, in combination with the MDI panel, it is possible to specify operations not supported by the machine operator's panel, such as mode change, override value change, and jog feed commands.

Note, however, that if the MDI panel keys are operated inadvertently, the machine may behave unexpectedly, possibly damaging the tool, the machine itself, the workpiece, or causing injury to the user.

9. Manual intervention

If manual intervention is performed during programmed operation of the machine, the tool path may vary when the machine is restarted. Before restarting the machine after manual intervention, therefore, confirm the settings of the manual absolute switches, parameters, and absolute/incremental command mode.

10. Feed hold, override, and single block

The feed hold, feedrate override, and single block functions can be disabled using custom macro system variable #3004. Be careful when operating the machine in this case.

11. Dry run

Usually, a dry run is used to confirm the operation of the machine. During a dry run, the machine operates at dry run speed, which differs from the corresponding programmed feedrate. Note that the dry run speed may sometimes be higher than the programmed feed rate.

12. Cutter and tool nose radius compensation in MDI mode

Pay careful attention to a tool path specified by a command in MDI mode, because cutter or tool nose radius compensation is not applied. When a command is entered from the MDI to interrupt in automatic operation in cutter or tool nose radius compensation mode, pay particular attention to the tool path when automatic operation is subsequently resumed. Refer to the descriptions of the corresponding functions for details.

13. Program editing

If the machine is stopped, after which the machining program is edited (modification, insertion, or deletion), the machine may behave unexpectedly if machining is resumed under the control of that program. Basically, do not modify, insert, or delete commands from a machining program while it is in use.


5

WARNINGS RELATED TO DAILY MAINTENANCE

WARNING

1. Memory backup battery replacement

When replacing the memory backup batteries, keep the power to the machine (CNC) turned on, and apply an emergency stop to the machine. Because this work is performed with the power on and the cabinet open, only those personnel who have received approved safety and maintenance training may perform this work.

When replacing the batteries, be careful not to touch the high-voltage circuits (marked  and fitted with an insulating cover).

Touching the uncovered high-voltage circuits presents an extremely dangerous electric shock hazard.

NOTE

The CNC uses batteries to preserve the contents of its memory, because it must retain data such as programs, offsets, and parameters even while external power is not applied.


If the battery voltage drops, a low battery voltage alarm is displayed on the machine operator's panel or CRT screen.

When a low battery voltage alarm is displayed, replace the batteries within a week. Otherwise, the contents of the CNC's memory will be lost.

Refer to the maintenance section of the operator's manual or programming manual for details of the battery replacement procedure.

WARNING**2. Absolute pulse coder battery replacement**

When replacing the memory backup batteries, keep the power to the machine (CNC) turned on, and apply an emergency stop to the machine. Because this work is performed with the power on and the cabinet open, only those personnel who have received approved safety and maintenance training may perform this work.

When replacing the batteries, be careful not to touch the high-voltage circuits (marked  and fitted with an insulating cover).

Touching the uncovered high-voltage circuits presents an extremely dangerous electric shock hazard.

NOTE

The absolute pulse coder uses batteries to preserve its absolute position.

If the battery voltage drops, a low battery voltage alarm is displayed on the machine operator's panel or CRT screen.

When a low battery voltage alarm is displayed, replace the batteries within a week. Otherwise, the absolute position data held by the pulse coder will be lost.


Refer to the maintenance section of the operator's manual or programming manual for details of the battery replacement procedure.

WARNING**3. Fuse replacement**

For some units, the chapter covering daily maintenance in the operator's manual or programming manual describes the fuse replacement procedure.

Before replacing a blown fuse, however, it is necessary to locate and remove the cause of the blown fuse.

For this reason, only those personnel who have received approved safety and maintenance training may perform this work.

When replacing a fuse with the cabinet open, be careful not to touch the high-voltage circuits (marked  and fitted with an insulating cover).

Touching an uncovered high-voltage circuit presents an extremely dangerous electric shock hazard.

SAFETY PRECAUTIONS	s-1
I. GENERAL	
1. GENERAL	3
1.1 GENERAL FLOW OF OPERATION OF CNC MACHINE TOOL	5
1.2 NOTES ON READING THIS MANUAL	7
II. PROGRAMMING	
1. GENERAL	11
1.1 TOOL MOVEMENT ALONG WORKPIECE PARTS FIGURE-INTERPOLATION	12
1.2 FEED-FEED FUNCTION	14
1.3 PART DRAWING AND TOOL MOVEMENT	15
1.3.1 Reference Position (Machine-Specific Position)	15
1.3.2 Coordinate System on Part Drawing and Coordinate System Specified by CNC - Coordinate System	16
1.3.3 How to Indicate Command Dimensions for Moving the Tool - Absolute, Incremental Commands ..	19
1.4 CUTTING SPEED - SPINDLE SPEED FUNCTION	20
1.5 SELECTION OF TOOL USED FOR VARIOUS MACHINING - TOOL FUNCTION	21
1.6 COMMAND FOR MACHINE OPERATIONS - MISCELLANEOUS FUNCTION	22
1.7 PROGRAM CONFIGURATION	23
1.8 TOOL FIGURE AND TOOL MOTION BY PROGRAM	26
1.9 TOOL MOVEMENT RANGE - STROKE	27
2. CONTROLLED AXES	28
2.1 CONTROLLED AXES	29
2.2 AXIS NAME	29
2.3 INCREMENT SYSTEM	31
2.4 MAXIMUM STROKE	32
3. PREPARATORY FUNCTION (G FUNCTION)	33
4. INTERPOLATION FUNCTIONS	38
4.1 POSITIONING (G00)	39
4.2 SINGLE DIRECTION POSITIONING (G60)	41
4.3 LINEAR INTERPOLATION (G01)	43
4.4 CIRCULAR INTERPOLATION (G02,G03)	45
4.5 HELICAL INTERPOLATION (G02,G03)	49
4.6 HELICAL INTERPOLATION B (G02, G03)	50
4.7 SPIRAL INTERPOLATION, CONICAL INTERPOLATION (G02, G03)	51
4.8 POLAR COORDINATEINTERPOLATION (G12.1,G13.1)	56
4.9 CYLINDRICAL INTERPOLATION (G07.1)	60
4.10 INVOLUTE INTERPOLATION (G02.2, G03.2)	63
4.11 EXPONENTIAL INTERPOLATION (G02.3, G03.3)	69

4.12	SMOOTH INTERPOLATION (G05.1)	73
4.13	NURBS INTERPOLATION (G06.2)	77
4.14	HYPOTHETICAL AXIS INTERPOLATION (G07)	82
4.15	THREAD CUTTING (G33)	84
4.16	SKIP FUNCTION(G31)	86
4.17	MULTISTAGE SKIP (G31)	88
4.18	HIGH SPEED SKIP SIGNAL (G31)	89
4.19	CONTINUOUS HIGH-SPEED SKIP FUNCTION (G31)	90
5.	FEED FUNCTIONS	91
5.1	GENERAL	92
5.2	RAPID TRAVERSE	94
5.3	CUTTING FEED	95
5.4	CUTTING FEEDRATE CONTROL	100
5.4.1	Exact Stop (G09, G61) Cutting Mode (G64) Tapping Mode (G63)	101
5.4.2	Automatic Corner Override	102
5.4.2.1	Automatic Override for Inner Corners (G62)	102
5.4.2.2	Internal Circular Cutting Feedrate Change	105
5.4.3	AUTOMATIC CORNER DECELERATION	106
5.4.3.1	Corner deceleration according to the corner angle	106
5.4.3.2	Corner deceleration according to the feedrate difference between blocks along each axis	109
5.5	DWELL (G04)	113
6.	REFERENCE POSITION	114
6.1	REFERENCE POSITION RETURN	115
6.2	FLOATING REFERENCE POSITION RETURN (G30.1)	120
7.	COORDINATE SYSTEM	121
7.1	MACHINE COORDINATE SYSTEM	122
7.2	WORKPIECE COORDINATE SYSTEM	123
7.2.1	Setting a Workpiece Coordinate System	123
7.2.2	Selecting a Workpiece Coordinate System	124
7.2.3	Changing Workpiece Coordinate System	125
7.2.4	Workpiece coordinate system preset (G92.1)	128
7.2.5	Adding Workpiece Coordinate Systems (G54.1 or G54)	130
7.3	LOCAL COORDINATE SYSTEM	132
7.4	PLANE SELECTION	134
8.	COORDINATE VALUE AND DIMENSION	135
8.1	ABSOLUTE AND INCREMENTAL PROGRAMMING (G90, G91)	136
8.2	POLAR COORDINATE COMMAND (G15, G16)	137
8.3	INCH/METRIC CONVERSION (G20,G21)	140
8.4	DECIMAL POINT PROGRAMMING	141
9.	SPINDLE SPEED FUNCTION (S FUNCTION)	142
9.1	SPECIFYING THE SPINDLE SPEED WITH A CODE	143

9.2	SPECIFYING THE SPINDLE SPEED VALUE DIRECTLY (S5-DIGIT COMMAND)	143
9.3	CONSTANT SURFACE SPEED CONTROL (G96, G97)	144
9.4	SPINDLE SPEED FLUCTUATION DETECTION FUNCTION (G25, G26)	147
10.	TOOL FUNCTION (T FUNCTION)	150
10.1	TOOL SELECTION FUNCTION	151
10.2	TOOL LIFE MANAGEMENT FUNCTION	152
10.2.1	Tool Life Management Data	153
10.2.2	Register, Change and Delete of Tool Life Management Data	154
10.2.3	Tool Life Management Command in a Machining Program	157
10.2.4	Tool Life	160
11.	AUXILIARY FUNCTION	161
11.1	AUXILIARY FUNCTION (M FUNCTION)	162
11.2	MULTIPLE M COMMANDS IN A SINGLE BLOCK	163
11.3	M CODE GROUP CHECK FUNCTION	164
11.4	THE SECOND AUXILIARY FUNCTIONS (B CODES)	165
12.	PROGRAM CONFIGURATION	166
12.1	PROGRAM COMPONENTS OTHER THAN PROGRAM SECTIONS	168
12.2	PROGRAM SECTION CONFIGURATION	171
12.3	SUBPROGRAM (M98, M99)	177
12.4	8-DIGIT PROGRAM NUMBER	181
13.	FUNCTIONS TO SIMPLIFY PROGRAMMING	184
13.1	CANNED CYCLE	185
13.1.1	High-speed Peck Drilling Cycle (G73)	189
13.1.2	Left-handed Tapping Cycle (G74)	191
13.1.3	Fine Boring Cycle (G76)	193
13.1.4	Drilling Cycle, Spot Drilling (G81)	195
13.1.5	Drilling Cycle Counter Boring Cycle (G82)	197
13.1.6	Peck Drilling Cycle (G83)	199
13.1.7	Small-hole peck drilling cycle (G83)	201
13.1.8	Tapping Cycle (G84)	205
13.1.9	Boring Cycle (G85)	207
13.1.10	Boring Cycle (G86)	209
13.1.11	Boring Cycle Back Boring Cycle (G87)	211
13.1.12	Boring Cycle (G88)	213
13.1.13	Boring Cycle (G89)	215
13.1.14	Canned Cycle Cancel (G80)	217
13.2	RIGID TAPPING	220
13.2.1	Rigid Tapping (G84)	221
13.2.2	Left-handed Rigid Tapping Cycle (G74)	224
13.2.3	Peck Rigid Tapping Cycle (G84 or G74)	227
13.2.4	Canned Cycle Cancel (G80)	229
13.3	CANNED GRINDING CYCLE (FOR GRINDING MACHINE)	230
13.3.1	Plunge Grinding Cycle (G75)	231
13.3.2	Direct Constant-dimension Plunge Grinding Cycle (G77)	233
13.3.3	Continuous-feed Surface Grinding Cycle (G78)	235
13.3.4	Intermittent-feed Surface Grinding Cycle (G79)	237

13.4	GRINDING–WHEEL WEAR COMPENSATION BY CONTINUOUS DRESSING (FOR GRINDING MACHINE)	239
13.5	AUTOMATIC GRINDING WHEEL DIAMETER COMPENSATION AFTER DRESSING	240
13.5.1	Checking the Minimum Grinding Wheel Diameter (for grinding machine)	240
13.6	IN–FEED GRINDING ALONG THE Y AND Z AXES AT THE END OF TABLE SWING (FOR GRINDING MACHINE)	241
13.7	OPTIONAL ANGLE CHAMFERING AND CORNER ROUNDING	242
13.8	EXTERNAL MOTION FUNCTION (G81)	245
13.9	FIGURE COPY (G72.1, G72.2)	246
13.10	THREE–DIMENSIONAL COORDINATE CONVERSION (G68, G69)	253
13.11	INDEX TABLE INDEXING FUNCTION	260
14.	COMPENSATION FUNCTION	263
14.1	TOOL LENGTH OFFSET (G43,G44,G49)	264
14.1.1	General	264
14.1.2	G53, G28, G30, and G30.1 Commands in Tool Length Offset Mode	269
14.2	AUTOMATIC TOOL LENGTH MEASUREMENT (G37)	272
14.3	TOOL OFFSET (G45–G48)	276
14.4	CUTTER COMPENSATION B (G39 – G42)	281
14.4.1	Cutter Compensation Left (G41)	284
14.4.2	Cutter Compensation Right (G42)	286
14.4.3	Corner Offset Circular Interpolation (G39)	288
14.4.4	Cutter Compensation Cancel (G40)	289
14.4.5	Switch between Cutter Compensation Left and Cutter Compensation Right	290
14.4.6	Change of the Cutter Compensation Value	291
14.4.7	Positive/Negative Cutter Compensation Value and Tool Center Path	292
14.5	OVERVIEW OF CUTTER COMPENSATION C (G40 – G42)	294
14.6	DETAILS OF CUTTER COMPENSATION C	300
14.6.1	General	300
14.6.2	Tool Movement in Start–up	301
14.6.3	Tool Movement in Offset Mode	305
14.6.4	Tool Movement in Offset Mode Cancel	319
14.6.5	Interference Check	325
14.6.6	Overcutting by Cutter Compensation	330
14.6.7	Input Command from MDI	333
14.6.8	G53,G28,G30,G30.1 and G29 Commands in Cutter Compensation C Mode	334
14.6.9	Corner Circular Interpolation (G39)	353
14.7	THREE–DIMENSIONAL TOOL COMPENSATION (G40, G41)	355
14.8	TOOL COMPENSATION VALUES, NUMBER OF COMPENSATION VALUES, AND ENTERING VALUES FROM THE PROGRAM (G10)	359
14.9	SCALING (G50,G51)	361
14.10	COORDINATE SYSTEM ROTATION (G68, G69)	366
14.11	NORMAL DIRECTION CONTROL (G40.1, G41.1, G42.1 OR G150, G151, G152)	372
14.12	PROGRAMMABLE MIRROR IMAGE (G50.1, G51.1)	377
14.13	GRINDING WHEEL WEAR COMPENSATION	379
15.	CUSTOM MACRO	383
15.1	VARIABLES	384
15.2	SYSTEM VARIABLES	388

15.3	ARITHMETIC AND LOGIC OPERATION	396
15.4	MACRO STATEMENTS AND NC STATEMENTS	401
15.5	BRANCH AND REPETITION	402
15.5.1	Unconditional Branch (GOTO Statement)	402
15.5.2	Conditional Branch (IF Statement)	403
15.5.3	Repetition (While Statement)	404
15.6	MACRO CALL	407
15.6.1	Simple Call (G65)	408
15.6.2	Modal Call (G66)	412
15.6.3	Macro Call Using G Code	414
15.6.4	Macro Call Using an M Code	415
15.6.5	Subprogram Call Using an M Code	416
15.6.6	Subprogram Calls Using a T Code	417
15.6.7	Sample Program	418
15.7	PROCESSING MACRO STATEMENTS	420
15.8	REGISTERING CUSTOM MACRO PROGRAMS	422
15.9	LIMITATIONS	423
15.10	EXTERNAL OUTPUT COMMANDS	424
15.11	INTERRUPTION TYPE CUSTOM MACRO	428
15.11.1	Specification Method	429
15.11.2	Details of Functions	430
16.	PATTERN DATA INPUT FUNCTION	438
16.1	DISPLAYING THE PATTERN MENU	439
16.2	PATTERN DATA DISPLAY	443
16.3	CHARACTERS AND CODES TO BE USED FOR THE PATTERN DATA INPUT FUNCTION	447
17.	PROGRAMMABLE PARAMETER ENTRY (G10)	449
18.	MEMORY OPERATION USING FS15 TAPE FORMAT	451
19.	HIGH SPEED CUTTING FUNCTIONS	452
19.1	HIGH-SPEED CYCLE CUTTING	453
19.2	FEEDRATE CLAMPING BY ARC RADIUS	455
19.3	LOOK-AHEAD CONTROL (G08)	456
19.4	HIGH-SPEED REMOTE BUFFER	458
19.4.1	High-speed remote buffer A (G05)	458
19.4.2	High-speed remote buffer B (G05)	461
19.5	HIGH-PRECISION CONTOUR CONTROL	462
19.6	SIMPLE HIGH-PRECISION CONTOUR CONTROL (G05.1)	470
19.7	DISTRIBUTION PROCESSING TERMINATION MONITORING FUNCTION FOR THE HIGH-SPEED MACHINING COMMAND (G05)	475
19.8	HIGH-SPEED LINEAR INTERPOLATION (G05)	476
20.	AXIS CONTROL FUNCTIONS	479
20.1	SIMPLE SYNCHRONOUS CONTROL	480
20.2	ROTARY AXIS ROLL-OVER	483

20.3	TOOL WITHDRAWAL AND RETURN (G10.6)	484
20.4	TANDEM CONTROL	487
20.5	ANGULAR AXIS CONTROL/ANGULAR AXIS CONTROL B	488
20.6	CHOPPING FUNCTION (G80, G81.1)	490
20.7	HOBBIING MACHINE FUNCTION (G80, G81)	496
20.8	SIMPLE ELECTRIC GEAR BOX (G80, G81)	502
20.9	RETREAT AND RETRY FUNCTIONS	507

21.TWO-PATH CONTROL FUNCTION **513**

21.1	GENERAL	514
21.2	WAITING FOR PATHS	515
21.3	MEMORY COMMON TO PATH	517
21.4	COPYING A PROGRAM BETWEEN TWO PATHS	518

III. OPERATION

1. GENERAL **521**



1.1	MANUAL OPERATION	522
1.2	TOOL MOVEMENT BY PROGRAMING – AUTOMATIC OPERATION	524
1.3	AUTOMATIC OPERATION	525
1.4	TESTING A PROGRAM	527
1.4.1	Check by Running the Machine	527
1.4.2	How to View the Position Display Change without Running the Machine	528
1.5	EDITING A PART PROGRAM	529
1.6	DISPLAYING AND SETTING DATA	530
1.7	DISPLAY	533
1.7.1	Program Display	533
1.7.2	Current Position Display	534
1.7.3	Alarm Display	534
1.7.4	Parts Count Display, Run Time Display	535
1.7.5	Graphic Display	535
1.8	DATA INPUT/OUTPUT	536





2. OPERATIONAL DEVICES **537**

2.1	SETTING AND DISPLAY UNITS	538
2.1.1	CNC Control Unit with 7.2"/8.4" LCD	539
2.1.2	CNC Control Unit with 9.5"/10.4" LCD	539
2.1.3	Separate-Type Small MDI Unit	540
2.1.4	Separate-Type Standard MDI Unit (Horizontal Type)	541
2.1.5	Separate-Type Standard MDI Unit (Vertical Type)	542
2.1.6	Separate-Type Standard MDI Unit (Vertical Type) (for 160i/180i)	543
2.2	EXPLANATION OF THE KEYBOARD	544
2.3	FUNCTION KEYS AND SOFT KEYS	546
2.3.1	General Screen Operations	546
2.3.2	Function Keys	547
2.3.3	Soft Keys	548
2.3.4	Key Input and Input Buffer	564
2.3.5	Warning Messages	565
2.3.6	Soft Key Configuration	566

2.4	EXTERNAL I/O DEVICES	567
2.4.1	FANUC Handy File	569
2.4.2	FANUC Floppy Cassette	569
2.4.3	FANUC FA Card	570
2.4.4	FANUC PPR	570
2.4.5	Portable Tape Reader	571
2.5	POWER ON/OFF	572
2.5.1	Turning on the Power	572
2.5.2	Screen Displayed at Power-on	573
2.5.3	Power Disconnection	574
3.	MANUAL OPERATION	575
3.1	MANUAL REFERENCE POSITION RETURN	576
3.2	JOG FEED	578
3.3	INCREMENTAL FEED	580
3.4	MANUAL HANDLE FEED	581
3.5	MANUAL ABSOLUTE ON AND OFF	584
3.6	TOOL AXIS DIRECTION HANDLE FEED/TOOL AXIS DIRECTION HANDLE FEED B	589
3.6.1	Tool Axis Direction Handle Feed	589
3.6.2	Tool Axis Normal Direction Handle Feed	592
3.7	MANUAL LINEAR/CIRCULAR INTERPOLATION	597
3.8	MANUAL RIGID TAPPING	602
3.9	MANUAL NUMERIC COMMAND	604
4.	AUTOMATIC OPERATION	612
4.1	MEMORY OPERATION	613
4.2	MDI OPERATION	616
4.3	DNC OPERATION	620
4.4	SIMULTANEOUS INPUT/OUTPUT	623
4.5	PROGRAM RESTART	625
4.6	SCHEDULING FUNCTION	632
4.7	SUBPROGRAM CALL FUNCTION (M198)	637
4.8	MANUAL HANDLE INTERRUPTION	639
4.9	MIRROR IMAGE	642
4.10	TOOL WITHDRAWAL AND RETURN	644
4.11	RETRACE FUNCTION	650
4.12	MANUAL INTERVENTION AND RETURN	658
4.13	RETREAT AND RETRY FUNCTION	660
5.	TEST OPERATION	664
5.1	MACHINE LOCK AND AUXILIARY FUNCTION LOCK	665
5.2	FEEDRATE OVERRIDE	667
5.3	RAPID TRAVERSE OVERRIDE	668
5.4	DRY RUN	669
5.5	SINGLE BLOCK	670

6. SAFETY FUNCTIONS	672
6.1 EMERGENCY STOP	673
6.2 OVERTRAVEL	674
6.3 STROKE CHECK	675
6.4 STROKE LIMIT CHECK PRIOR TO PERFORMING MOVEMENT	679
7. ALARM AND SELF-DIAGNOSIS FUNCTIONS	682
7.1 ALARM DISPLAY	683
7.2 ALARM HISTORY DISPLAY	685
7.3 CHECKING BY SELF-DIAGNOSTIC SCREEN	686
8. DATA INPUT/OUTPUT	689
8.1 FILES	690
8.2 FILE SEARCH	692
8.3 FILE DELETION	694
8.4 PROGRAM INPUT/OUTPUT	695
8.4.1 Inputting a Program	695
8.4.2 Outputting a Program	698
8.5 OFFSET DATA INPUT AND OUTPUT	700
8.5.1 Inputting Offset Data	700
8.5.2 Outputting Offset Data	701
8.6 INPUTTING AND OUTPUTTING PARAMETERS AND PITCH ERROR COMPENSATION DATA	702
8.6.1 Inputting Parameters	702
8.6.2 Outputting Parameters	703
8.6.3 Inputting Pitch error compensation data	704
8.6.4 Outputting Pitch Error Compensation Data	705
8.7 INPUTTING/OUTPUTTING CUSTOM MACRO COMMON VARIABLES	706
8.7.1 Inputting Custom Macro Common Variables	706
8.7.2 Outputting Custom Macro Common Variable	707
8.8 DISPLAYING DIRECTORY OF FLOPPY CASSETTE	708
8.8.1 Displaying the Directory	709
8.8.2 Reading Files	712
8.8.3 Outputting Programs	713
8.8.4 Deleting Files	714
8.9 OUTPUTTING A PROGRAM LIST FOR A SPECIFIED GROUP	716
8.10 DATA INPUT/OUTPUT ON THE ALL IO SCREEN	717
8.10.1 Setting Input/Output-Related Parameters	718
8.10.2 Inputting and Outputting Programs	719
8.10.3 Inputting and Outputting Parameters	724
8.10.4 Inputting and Outputting Offset Data	726
8.10.5 Outputting Custom Macro Common Variables	728
8.10.6 Inputting and Outputting Floppy Files	729
8.10.7 Memory Card Input/Output	734
8.11 DATA INPUT/OUTPUT USING A MEMORY CARD	743
9. EDITING PROGRAMS	755
9.1 INSERTING, ALTERING AND DELETING A WORD	756
9.1.1 Word Search	757
9.1.2 Heading a Program	759

9.1.3	Inserting a Word	760
9.1.4	Altering a Word	761
9.1.5	Deleting a Word	762
9.2	DELETING BLOCKS	763
9.2.1	Deleting a Block	763
9.2.2	Deleting Multiple Blocks	764
9.3	PROGRAM NUMBER SEARCH	765
9.4	SEQUENCE NUMBER SEARCH	766
9.5	DELETING PROGRAMS	768
9.5.1	Deleting One Program	768
9.5.2	Deleting All Programs	768
9.5.3	Deleting More Than One Program by Specifying a Range	769
9.6	EXTENDED PART PROGRAM EDITING FUNCTION	770
9.6.1	Copying an Entire Program	771
9.6.2	Copying Part of a Program	772
9.6.3	Moving Part of a Program	773
9.6.4	Merging a Program	774
9.6.5	Supplementary Explanation for Copying, Moving and Merging	775
9.6.6	Replacement of Words and Addresses	777
9.7	EDITING OF CUSTOM MACROS	779
9.8	BACKGROUND EDITING	780
9.9	PASSWORD FUNCTION	781
9.10	COPYING A PROGRAM BETWEEN TWO PATHS	783
10	CREATING PROGRAMS	788
10.1	CREATING PROGRAMS USING THE MDI PANEL	789
10.2	AUTOMATIC INSERTION OF SEQUENCE NUMBERS	790
10.3	CREATING PROGRAMS IN TEACH IN MODE (PLAYBACK)	792
10.4	CONVERSATIONAL PROGRAMMING WITH GRAPHIC FUNCTION	795
11	SETTING AND DISPLAYING DATA	799
11.1	SCREENS DISPLAYED BY FUNCTION KEY 	806
11.1.1	Position Display in the Work Coordinate System	807
11.1.2	Position Display in the Relative Coordinate System	809
11.1.3	Overall Position Display	812
11.1.4	Presetting the Workpiece Coordinate System	814
11.1.5	Actual Feedrate Display	815
11.1.6	Display of Run Time and Parts Count	817
11.1.7	Setting the Floating Reference Position	818
11.1.8	Operating Monitor Display	819
11.2	SCREENS DISPLAYED BY FUNCTION KEY  (IN MEMORY MODE OR MDI MODE)	821
11.2.1	Program Contents Display	822
11.2.2	Current Block Display Screen	823
11.2.3	Next Block Display Screen	824
11.2.4	Program Check Screen	825
11.2.5	Program Screen for MDI Operation	828
11.2.6	Stamping the Machining Time	829

11.3	SCREENS DISPLAYED BY FUNCTION KEY 	
	(IN THE EDIT MODE)	837
11.3.1	Displaying Memory Used and a List of Programs	837
11.3.2	Displaying a Program List for a Specified Group	840
11.4	SCREENS DISPLAYED BY FUNCTION KEY 	843
11.4.1	Setting and Displaying the Tool Offset Value	844
11.4.2	Tool Length Measurement	847
11.4.3	Displaying and Entering Setting Data	849
11.4.4	Sequence Number Comparison and Stop	851
11.4.5	Displaying and Setting Run Time,Parts Count, and Time	853
11.4.6	Displaying and Setting the Workpiece Origin Offset Value	855
11.4.7	Direct Input of Measured Workpiece Origin Offsets	856
11.4.8	Displaying and Setting Custom Macro Common Variables	858
11.4.9	Displaying Pattern Data and Pattern Menu	859
11.4.10	Displaying and Setting the Software Operator's Panel	861
11.4.11	Displaying and Setting Tool Life Management Data	863
11.4.12	Displaying and Setting Extended Tool Life Management	866
11.4.13	Displaying and Setting Chopping Data	871
11.4.14	Tool Length/Workpiece Origin Measurement B	872
11.5	SCREENS DISPLAYED BY FUNCTION KEY 	889
11.5.1	Displaying and Setting Parameters	890
11.5.2	Displaying and Setting Pitch Error Compensation Data	892
11.6	DISPLAYING THE PROGRAM NUMBER, SEQUENCE NUMBER, AND STATUS, AND WARNING MESSAGES FOR DATA SETTING OR INPUT/OUTPUT OPERATION	894
11.6.1	Displaying the Program Number and Sequence Number	894
11.6.2	Displaying the Status and Warning for Data Setting or Input/Output Operation	895
11.7	SCREENS DISPLAYED BY FUNCTION KEY 	897
11.7.1	External Operator Message History Display	897
11.8	CLEARING THE SCREEN	899
11.8.1	Erase Screen Display	899
11.8.2	Automatic Erase Screen Display	900
12.	GRAPHICS FUNCTION	901
12.1	GRAPHICS DISPLAY	902
12.2	DYNAMIC GRAPHIC DISPLAY	908
12.2.1	Path Drawing	908
12.2.2	Solid Graphics	917
12.3	BACKGROUND DRAWING	930
13.	HELP FUNCTION	933
IV.	MAINTENANCE	
1.	METHOD OF REPLACING BATTERY	941
1.1	REPLACING THE ALKALINE DRY CELLS (SIZE D)	944
1.2	USE OF ALKALINE DRY CELLS (SIZE D)	945
1.3	BATTERY FOR SEPARATE ABSOLUTE PULSE CODERS	946

APPENDIX

A. TAPE CODE LIST	949
B. LIST OF FUNCTIONS AND TAPE FORMAT	952
C. RANGE OF COMMAND VALUE	957
D. NOMOGRAPHS	960
D.1 INCORRECT THREADED LENGTH	961
D.2 SIMPLE CALCULATION OF INCORRECT THREAD LENGTH	963
D.3 TOOL PATH AT CORNER	965
D.4 RADIUS DIRECTION ERROR AT CIRCLE CUTTING	968
E. STATUS WHEN TURNING POWER ON, WHEN CLEAR AND WHEN RESET	969
F. CHARACTER-TO-CODES CORRESPONDENCE TABLE	971
G. ALARM LIST	972
H. OPERATION OF PORTABLE TAPE READER	994

I. GENERAL

1

GENERAL

About this manual

This manual consists of the following parts:

I. GENERAL

Describes chapter organization, applicable models, related manuals, and notes for reading this manual.

II. PROGRAMMING

Describes each function: Format used to program functions in the NC language, characteristics, and restrictions. When a program is created through conversational automatic programming function, refer to the manual for the conversational automatic programming function (Table 1).

III. OPERATION

Describes the manual operation and automatic operation of a machine, procedures for inputting and outputting data, and procedures for editing a program.

IV. MAINTENANCE

Describes procedures for replacing batteries.

APPENDIX

Lists tape codes, valid data ranges, and error codes.

Some functions described in this manual may not be applied to some products. For detail, refer to the DESCRIPTIONS manual(B-63002EN).

This manual does not describe parameters in detail. For details on parameters mentioned in this manual, refer to the manual for parameters (B-63010EN).

This manual describes all optional functions. Look up the options incorporated into your system in the manual written by the machine tool builder.

The models covered by this manual, and their abbreviations are:

Product name	Abbreviations	
FANUC Series 16i-MA	16i-MA	Series 16i
FANUC Series 18i-MA	18i-MA	Series 18i
FANUC Series 160i-MA	160i-MA	Series 160i
FANUC Series 180i-MA	180i-MA	Series 180i

Special symbols

This manual uses the following symbols:

- IP_ : Indicates a combination of axes such as X__ Y__ Z (used in PROGRAMMING.).
- ; : Indicates the end of a block. It actually corresponds to the ISO code LF or EIA code CR.

Related manuals

The table below lists manuals related to MODEL A of Series 16*i*, Series 18*i*, Series 160*i* and Series 180*i*. In the table, this manual is marked with an asterisk (*).

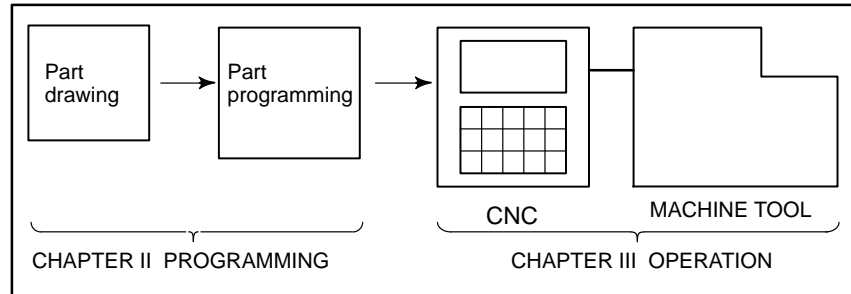
Table 1 Related Manuals

Manual name	Specification number	
DESCRIPTIONS	B-63002EN	
CONNECTION MANUAL (Hardware)	B-63003EN	
CONNECTION MANUAL (Function)	B-63003EN-1	
OPERATOR'S MANUAL for Lathe	B-63004EN	
OPERATOR'S MANUAL for Machining Center	B-63014EN	*
MAINTENANCE MANUAL	B-63005EN	
PARAMETER MANUAL	B-63010EN	
PROGRAMMING MANUAL (Macro Compiler / Macro Executer)	B-61803E-1	
FAPT MACRO COMPILER PROGRAMMING MANUAL	B-66102E	
FANUC Super CAP T/Super CAP II T OPERATOR'S MANUAL	B-62444E-1	
FANUC Super CAP M/Super CAP II M OPERATOR'S MANUAL	B-62154E	
FANUC Super CAP M PROGRAMMING MANUAL	B-62153E	
CONVERSATIONAL AUTOMATIC PROGRAMMING FUNCTION I for Lathe OPERATOR'S MANUAL	B-61804E-1	
CONVERSATIONAL AUTOMATIC PROGRAMMING FUNCTION II for Lathe OPERATOR'S MANUAL	B-61804E-2	
CONVERSATIONAL AUTOMATIC PROGRAMMING FUNCTION for MACHINING CENTER OPERATOR'S MANUAL	B-61874E-1	
FANUC Symbolic CAP T Basic module V1 OPERATOR'S MANUAL	B-62824EN	
FANUC Symbolic CAP T C/Y axis module V1 OPERATOR'S MANUAL	B-62824EN-1	
FANUC Symbolic CAP M Basic module V1 OPERATOR'S MANUAL	B-62984EN	

1.1 GENERAL FLOW OF OPERATION OF CNC MACHINE TOOL

When machining the part using the CNC machine tool, first prepare the program, then operate the CNC machine by using the program.

- 1) First, prepare the program from a part drawing to operate the CNC machine tool.
How to prepare the program is described in the Chapter II. PROGRAMMING.
- 2) The program is to be read into the CNC system. Then, mount the workpieces and tools on the machine, and operate the tools according to the programming. Finally, execute the machining actually.
How to operate the CNC system is described in the Chapter III. OPERATION.



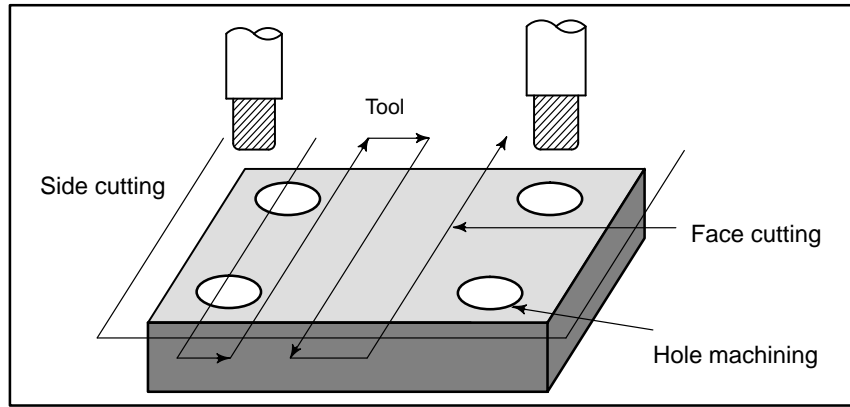
Before the actual programming, make the machining plan for how to machine the part.

Machining plan

1. Determination of workpieces machining range
2. Method of mounting workpieces on the machine tool
3. Machining sequence in every machining process
4. Machining tools and machining

Decide the machining method in every machining process.

Machining process \ Machining procedure	1	2	3
	Feed cutting	Side cutting	Hole machining
1. Machining method : Rough Semi Finish			
2. Machining tools			
3. Machining conditions : Feedrate Cutting depth			
4. Tool path			



Prepare the program of the tool path and machining condition according to the workpiece figure, for each machining.

1.2 NOTES ON READING THIS MANUAL

NOTE

- 1 The function of an CNC machine tool system depends not only on the CNC, but on the combination of the machine tool, its magnetic cabinet, the servo system, the CNC, the operator's panels, etc. It is too difficult to describe the function, programming, and operation relating to all combinations. This manual generally describes these from the stand-point of the CNC. So, for details on a particular CNC machine tool, refer to the manual issued by the machine tool builder, which should take precedence over this manual.
- 2 Headings are placed in the left margin so that the reader can easily access necessary information. When locating the necessary information, the reader can save time by searching through these headings.
- 3 Machining programs, parameters, variables, etc. are stored in the CNC unit internal non-volatile memory. In general, these contents are not lost by the switching ON/OFF of the power. However, it is possible that a state can occur where precious data stored in the non-volatile memory has to be deleted, because of deletions from a maloperation, or by a failure restoration. In order to restore rapidly when this kind of mishap occurs, it is recommended that you create a copy of the various kinds of data beforehand.
- 4 This manual describes as many reasonable variations in equipment usage as possible. It cannot address every combination of features, options and commands that should not be attempted.
If a particular combination of operations is not described, it should not be attempted.

II. PROGRAMMING

1

GENERAL



1.1 TOOL MOVEMENT ALONG WORKPIECE PARTS FIGURE– INTERPOLATION

The tool moves along straight lines and arcs constituting the workpiece parts figure (See II-4).

Explanations

The function of moving the tool along straight lines and arcs is called the interpolation.

- Tool movement along a straight line

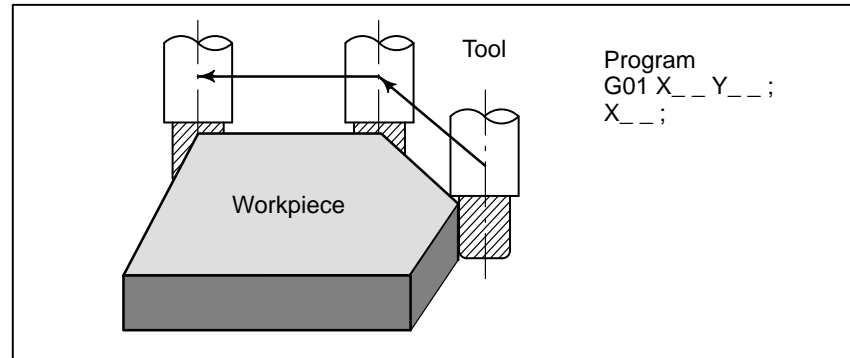


Fig.1.1 (a) Tool movement along a straight line

- Tool movement along an arc

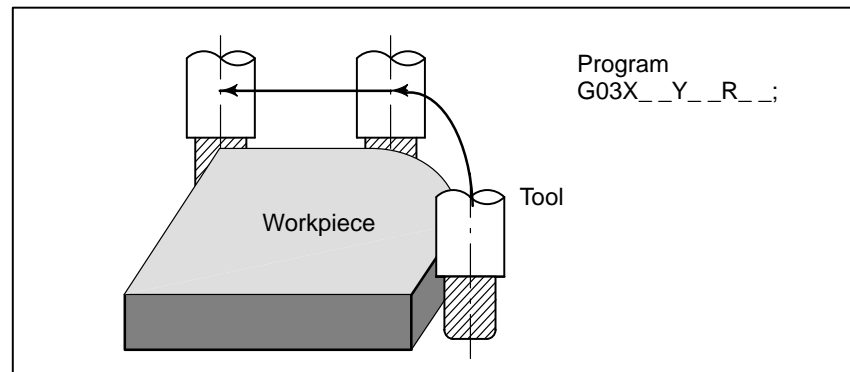


Fig. 1.1 (b) Tool movement along an arc

Symbols of the programmed commands G01, G02, ... are called the preparatory function and specify the type of interpolation conducted in the control unit.

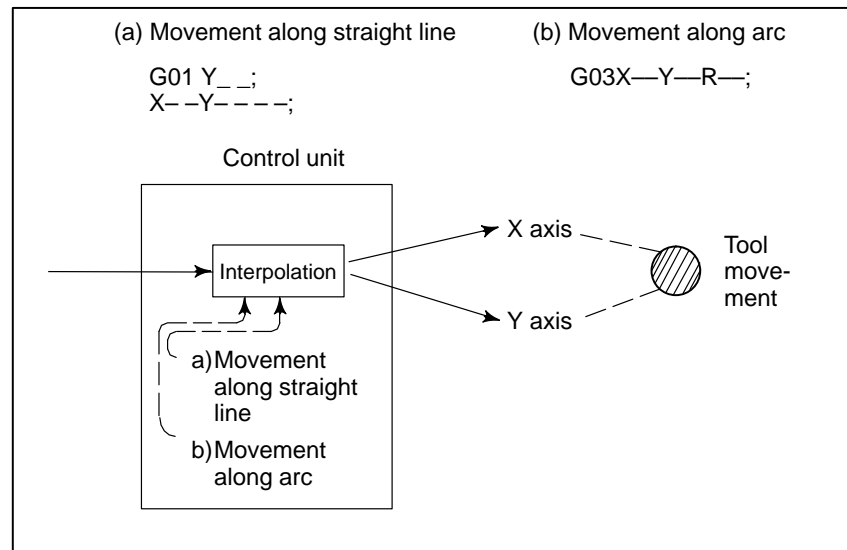


Fig. 1.1 (c) Interpolation function

NOTE

Some machines move tables instead of tools but this manual assumes that tools are moved against workpieces.

1.2 FEED- FEED FUNCTION

Movement of the tool at a specified speed for cutting a workpiece is called the feed.

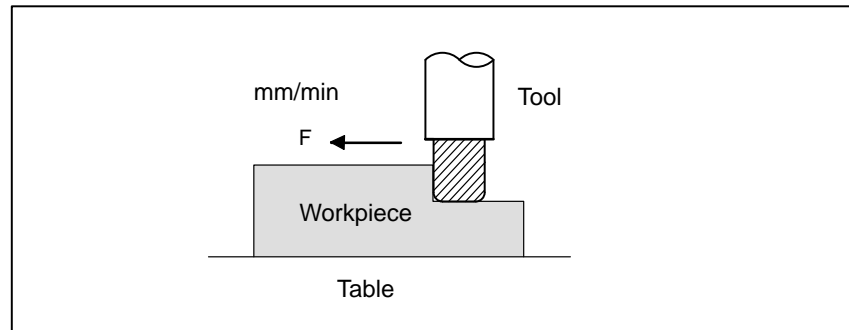


Fig. 1.2 (a) Feed function

Feedrates can be specified by using actual numerics. For example, to feed the tool at a rate of 150 mm/min, specify the following in the program:
F150.0

The function of deciding the feed rate is called the feed function (See II-5).

1.3 PART DRAWING AND TOOL MOVEMENT

1.3.1 Reference Position (Machine-Specific Position)

A CNC machine tool is provided with a fixed position. Normally, tool change and programming of absolute zero point as described later are performed at this position. This position is called the reference position.

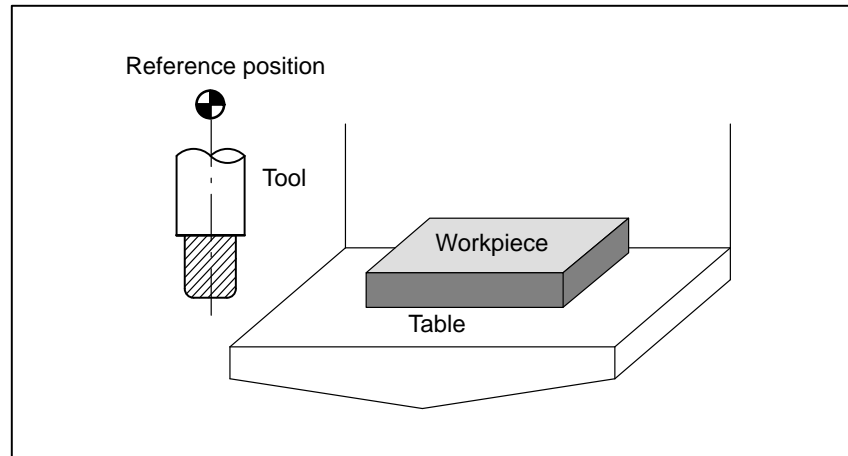


Fig. 1.3 (a) Reference position

Explanations

The tool can be moved to the reference position in two ways:

(1) Manual reference position return (See III-3.1)

Reference position return is performed by manual button operation.

(2) Automatic reference position return (See II-6)

In general, manual reference position return is performed first after the power is turned on. In order to move the tool to the reference position for tool change thereafter, the function of automatic reference position return is used.

1.3.2 Coordinate System on Part Drawing and Coordinate System Specified by CNC – Coordinate System

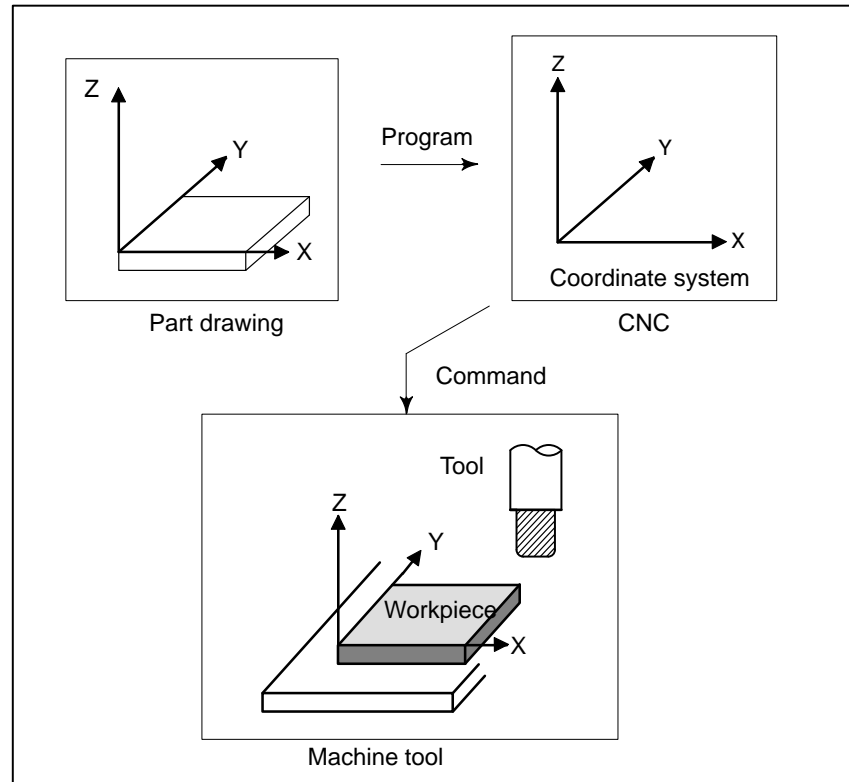


Fig. 1.3.2 (a) Coordinate system

Explanations

- **Coordinate system**

The following two coordinate systems are specified at different locations:
(See II-7)

(1) Coordinate system on part drawing

The coordinate system is written on the part drawing. As the program data, the coordinate values on this coordinate system are used.

(2) Coordinate system specified by the CNC

The coordinate system is prepared on the actual machine tool table. This can be achieved by programming the distance from the current position of the tool to the zero point of the coordinate system to be set.

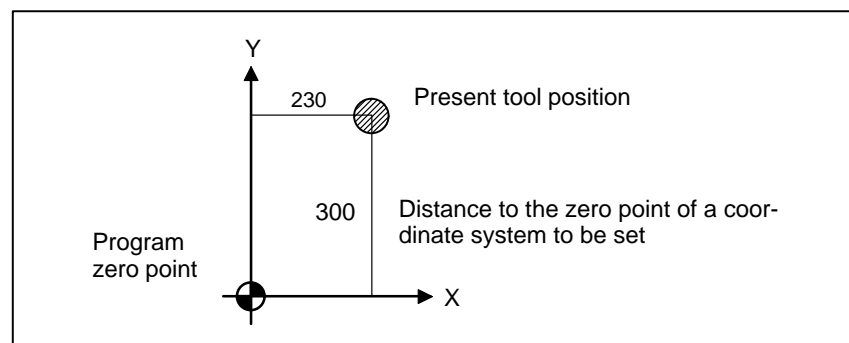


Fig. 1.3.2 (b) Coordinate system specified by the CNC

The positional relation between these two coordinate systems is determined when a workpiece is set on the table.

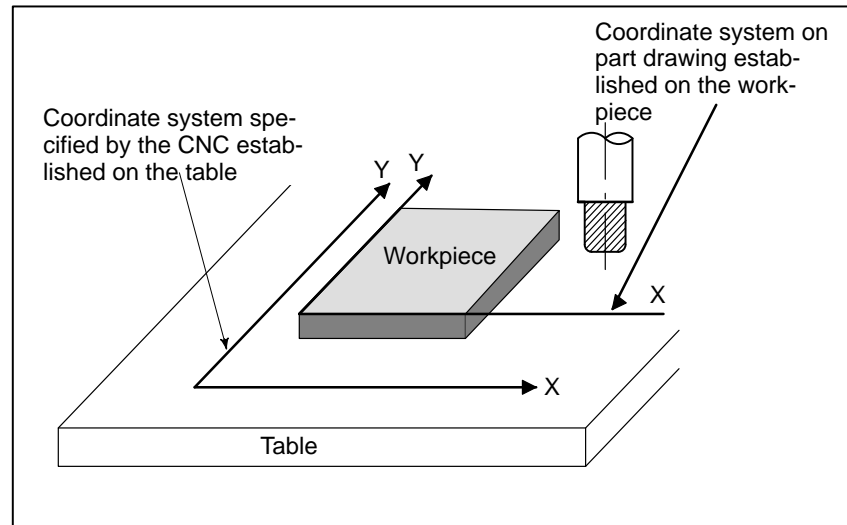


Fig. 1.3.2 (c) Coordinate system specified by CNC and coordinate system on part drawing

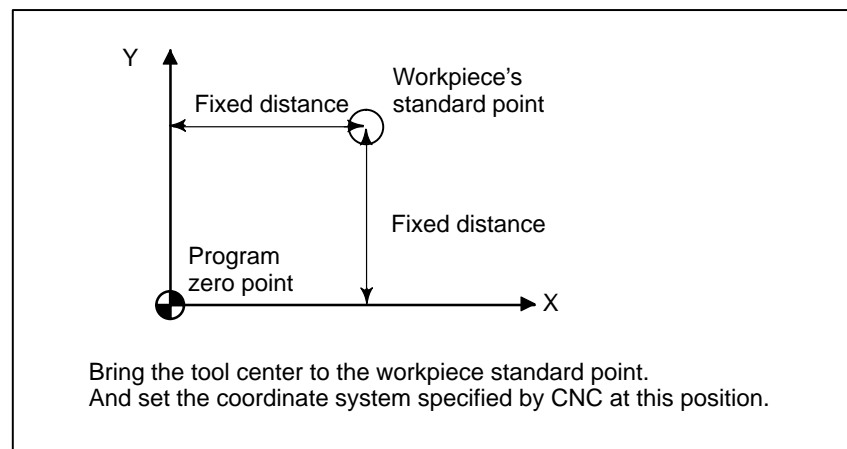
The tool moves on the coordinate system specified by the CNC in accordance with the command program generated with respect to the coordinate system on the part drawing, and cuts a workpiece into a shape on the drawing.

Therefore, in order to correctly cut the workpiece as specified on the drawing, the two coordinate systems must be set at the same position.

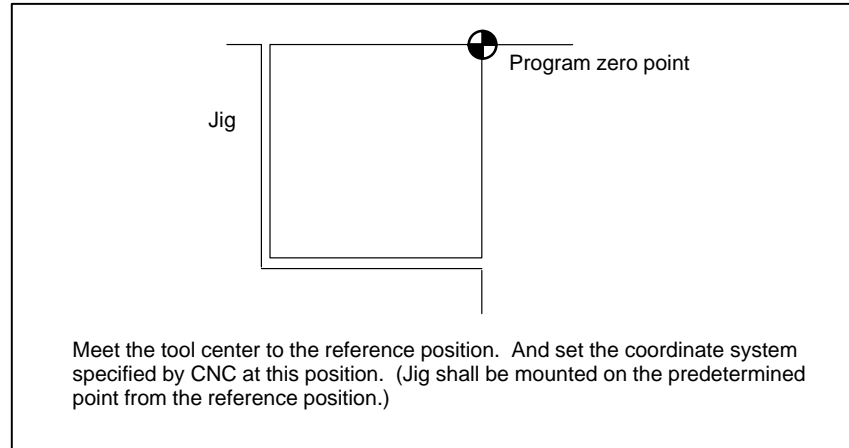
- **Methods of setting the two coordinate systems in the same position**

To set the two coordinate systems at the same position, simple methods shall be used according to workpiece shape, the number of machinings.

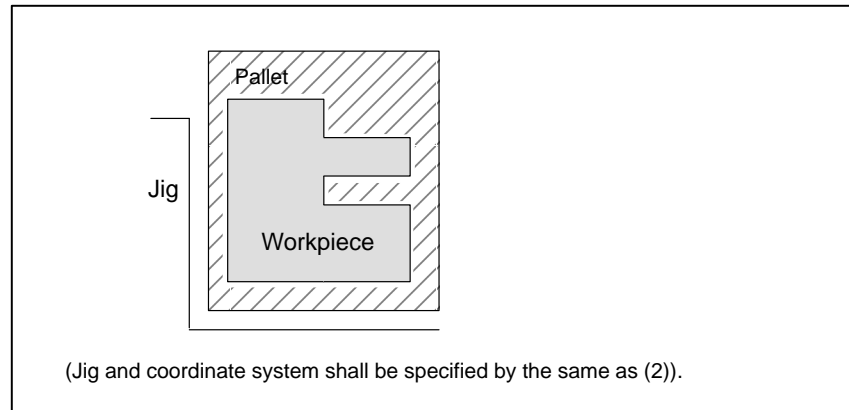
(1) Using a standard plane and point of the workpiece.



(2) Mounting a workpiece directly against the jig



(3) Mounting a workpiece on a pallet, then mounting the workpiece and pallet on the jig



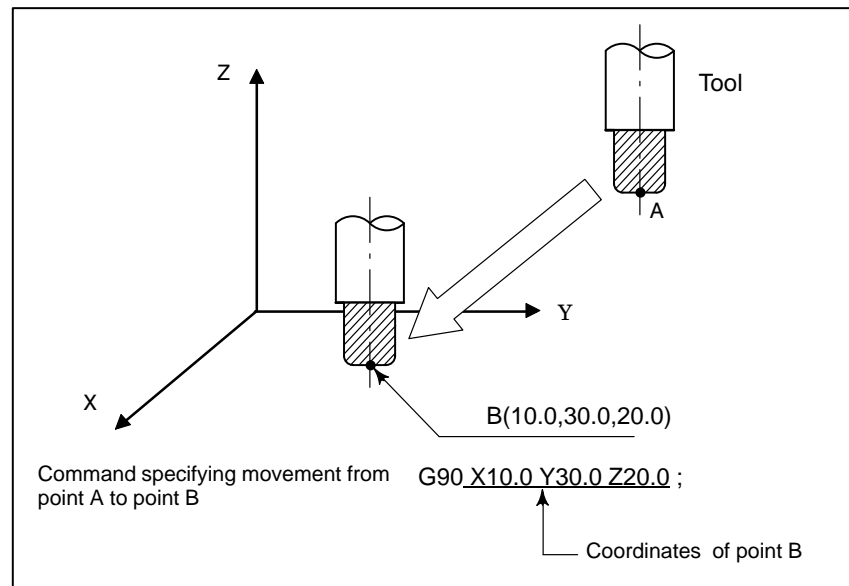
1.3.3 How to Indicate Command Dimensions for Moving the Tool – Absolute, Incremental Commands

Explanations

- **Absolute command**

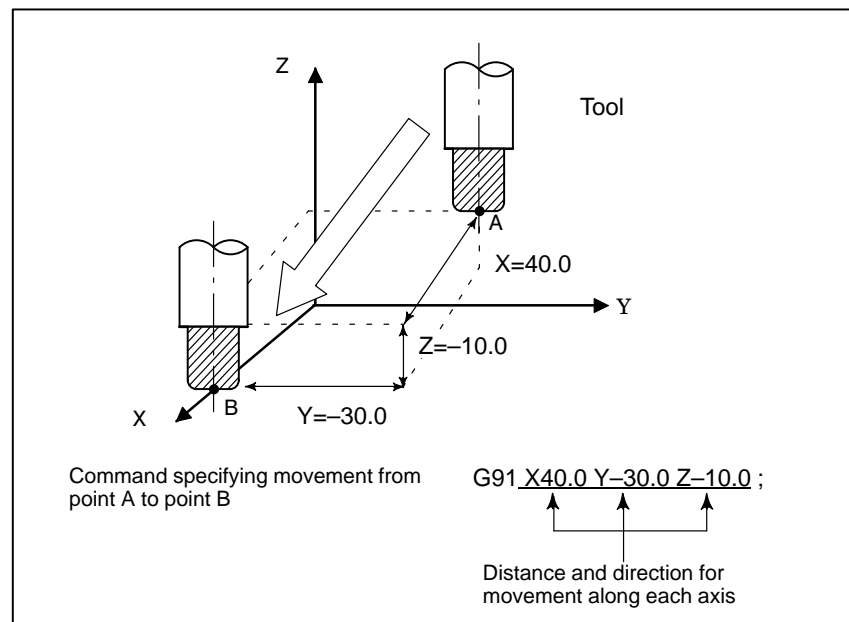
Command for moving the tool can be indicated by absolute command or incremental command (See II-8.1).

The tool moves to a point at “the distance from zero point of the coordinate system” that is to the position of the coordinate values.



- **Incremental command**

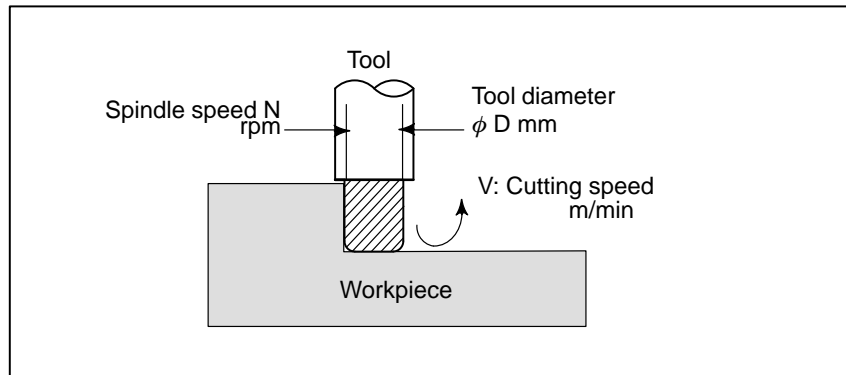
Specify the distance from the previous tool position to the next tool position.



1.4 CUTTING SPEED – SPINDLE SPEED FUNCTION

The speed of the tool with respect to the workpiece when the workpiece is cut is called the cutting speed.

As for the CNC, the cutting speed can be specified by the spindle speed in rpm unit.



Examples

<When a workpiece should be machined with a tool 100 mm in diameter at a cutting speed of 80 m/min. >

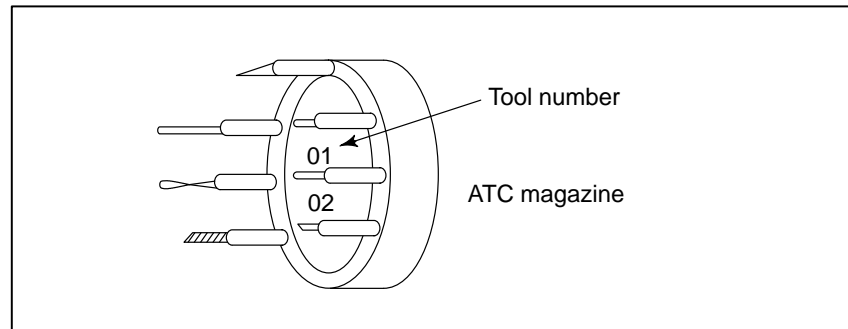
The spindle speed is approximately 250 rpm, which is obtained from $N=1000v/\pi D$. Hence the following command is required:

S250;

Commands related to the spindle speed are called the spindle speed function (See II-9) .

1.5 SELECTION OF TOOL USED FOR VARIOUS MACHINING – TOOL FUNCTION

When drilling, tapping, boring, milling or the like, is performed, it is necessary to select a suitable tool. When a number is assigned to each tool and the number is specified in the program, the corresponding tool is selected.



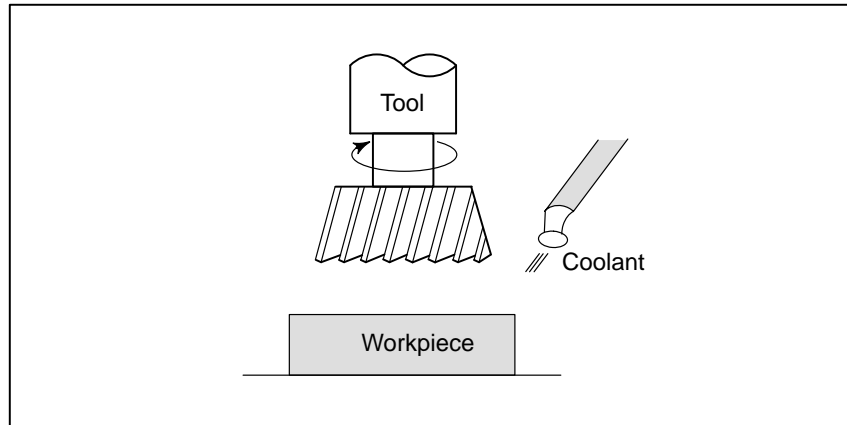
Examples

<When No.01 is assigned to a drilling tool>

When the tool is stored at location 01 in the ATC magazine, the tool can be selected by specifying T01. This is called the tool function (See II-10).

1.6 COMMAND FOR MACHINE OPERATIONS – MISCELLANEOUS FUNCTION

When machining is actually started, it is necessary to rotate the spindle, and feed coolant. For this purpose, on–off operations of spindle motor and coolant valve should be controlled.



The function of specifying the on–off operations of the components of the machine is called the miscellaneous function. In general, the function is specified by an M code (See II–11).

For example, when M03 is specified, the spindle is rotated clockwise at the specified spindle speed.

1.7 PROGRAM CONFIGURATION

A group of commands given to the CNC for operating the machine is called the program. By specifying the commands, the tool is moved along a straight line or an arc, or the spindle motor is turned on and off. In the program, specify the commands in the sequence of actual tool movements.

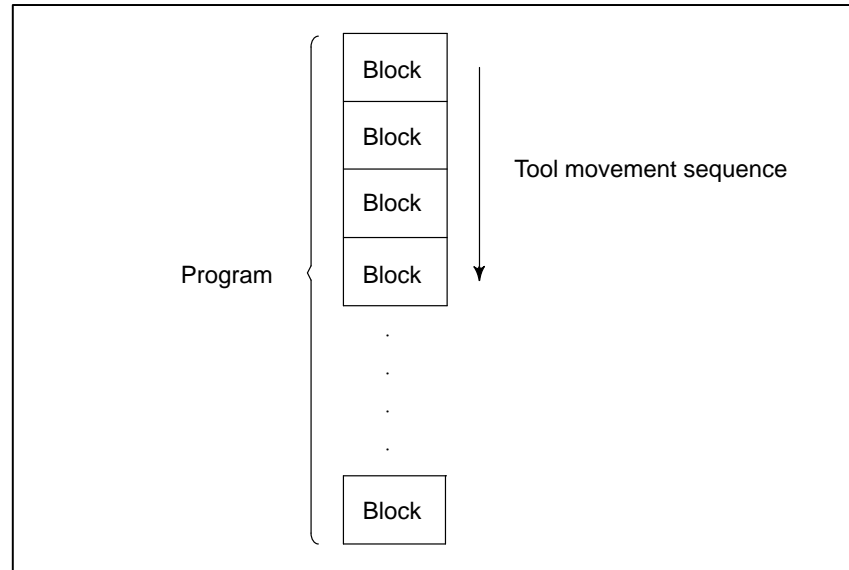


Fig. 1.7 (a) Program configuration

A group of commands at each step of the sequence is called the block. The program consists of a group of blocks for a series of machining. The number for discriminating each block is called the sequence number, and the number for discriminating each program is called the program number (See II-12).

Explanations

The block and the program have the following configurations.

• **Block**

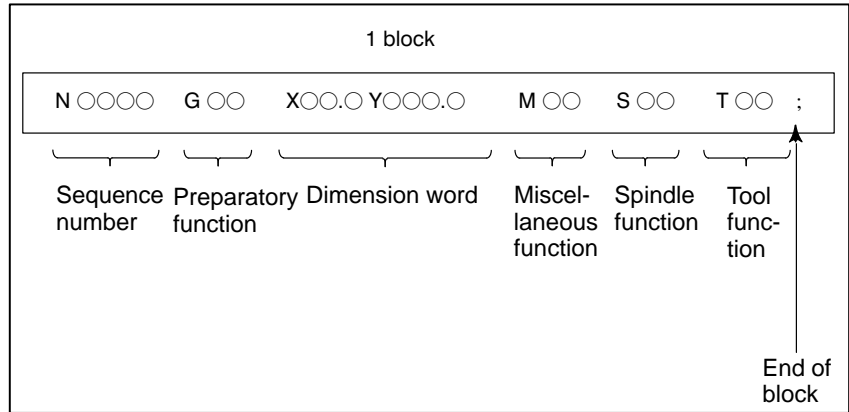


Fig. 1.7 (b) Block configuration

A block starts with a sequence number to identify the block and ends with an end-of-block code.

This manual indicates the end-of-block code by ; (LF in the ISO code and CR in the EIA code).

• **Program**

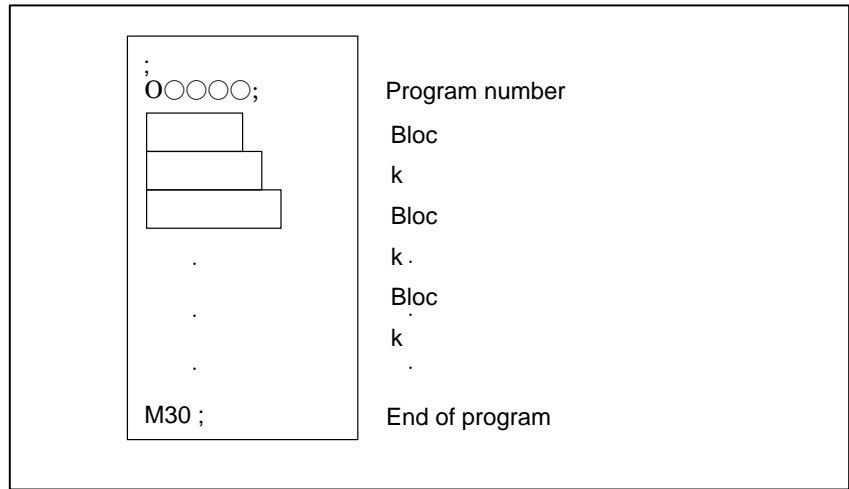
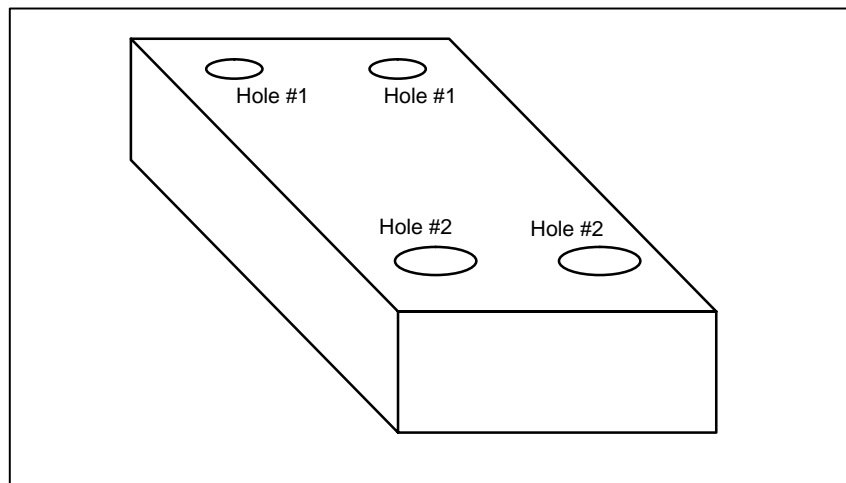
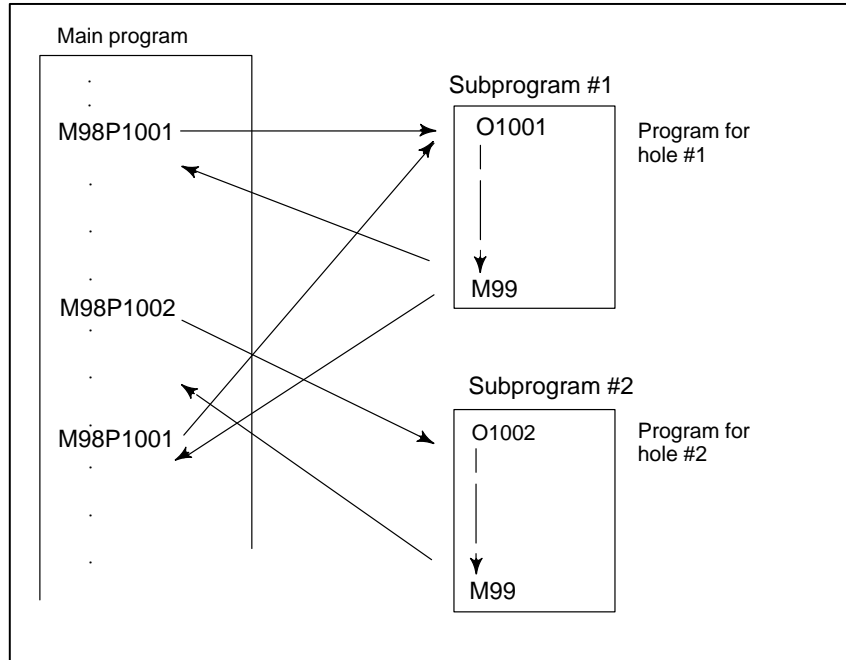


Fig. 1.7 (c) Program configuration

Normally, a program number is specified after the end-of-block (;) code at the beginning of the program, and a program end code (M02 or M30) is specified at the end of the program.

- **Main program and subprogram**

When machining of the same pattern appears at many portions of a program, a program for the pattern is created. This is called the subprogram. On the other hand, the original program is called the main program. When a subprogram execution command appears during execution of the main program, commands of the subprogram are executed. When execution of the subprogram is finished, the sequence returns to the main program.



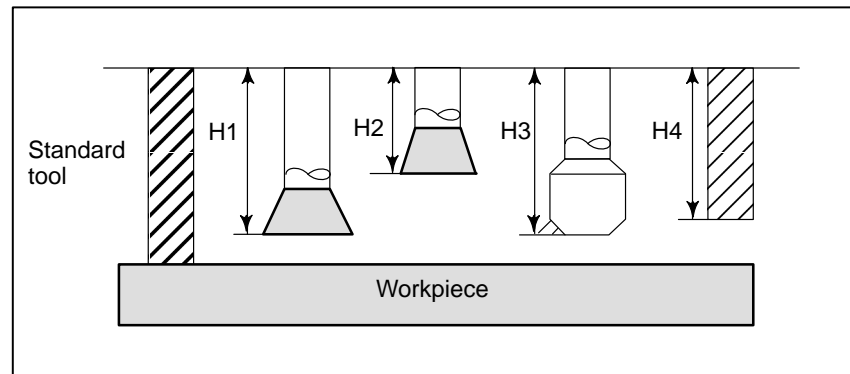
1.8 TOOL FIGURE AND TOOL MOTION BY PROGRAM

Explanations

- **Machining using the end of cutter – Tool length compensation function (See II-14.1)**

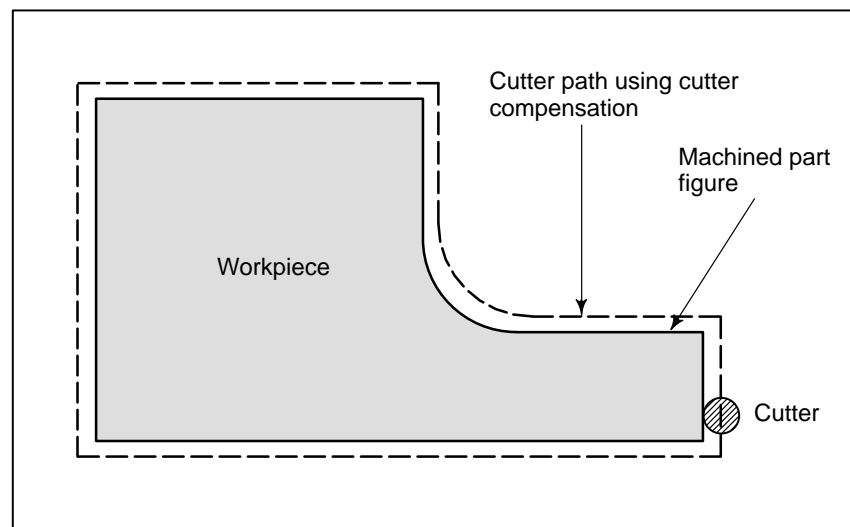
Usually, several tools are used for machining one workpiece. The tools have different tool length. It is very troublesome to change the program in accordance with the tools.

Therefore, the length of each tool used should be measured in advance. By setting the difference between the length of the standard tool and the length of each tool in the CNC (data display and setting : see III-11), machining can be performed without altering the program even when the tool is changed. This function is called tool length compensation.



- **Machining using the side of cutter – Cutter compensation function (See II-14.4,14.5,14.6)**

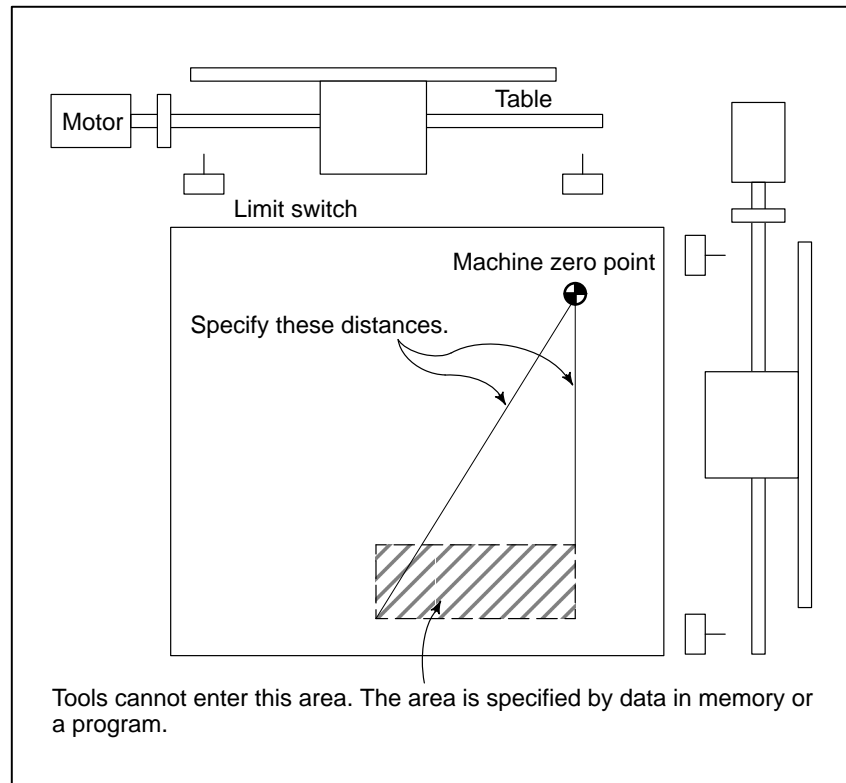
Because a cutter has a radius, the center of the cutter path goes around the workpiece with the cutter radius deviated.



If radius of cutters are stored in the CNC (Data Display and Setting : see III-11), the tool can be moved by cutter radius apart from the machining part figure. This function is called cutter compensation.

1.9 TOOL MOVEMENT RANGE – STROKE

Limit switches are installed at the ends of each axis on the machine to prevent tools from moving beyond the ends. The range in which tools can move is called the stroke.



Besides strokes defined with limit switches, the operator can define an area which the tool cannot enter using a program or data in memory. This function is called stroke check (see III-6.3).

2

CONTROLLED AXES



2.1 CONTROLLED AXES

Series 16, Series 160

Item	16i-MA 160i-MA	16i-MA, 160i-MA (two-path control)
No. of basic controlled axes	3 axes	3 axes for each path (6 axes in total)
Controlled axes expansion (total)	Max. 8 axes (included in Cs axis)	Max. 7 axes for each path (Feed 6 axes + Cs axis)
Basic simultaneously controlled axes	2 axes	2 axes for each path (4 axes in total)
Simultaneously controlled axes expansion (total)	Max. 6 axes	Max. 6 axes for each path

NOTE

The number of simultaneously controllable axes for manual operation jog feed, manual reference position return, or manual rapid traverse) is 1 or 3 (1 when bit 0 (JAX) of parameter 1002 is set to 0 and 3 when it is set to 1).

Series 18, Series 180

Item	18i-MA, 180i-MA
No. of basic controlled axes	3 axes
Controlled axes expansion (total)	Max. 6 axes (included in Cs axis)
Basic simultaneously controlled axes	2 axes
Simultaneously controlled axes expansion (total)	Max. 4 axes

NOTE

The number of simultaneously controllable axes for manual operation jog feed, manual reference position return, or manual rapid traverse) is 1 or 3 (1 when bit 0 (JAX) of parameter 1002 is set to 0 and 3 when it is set to 1).

2.2 AXIS NAME

The names of three basic axes are always X, Y, and Z. The name of an additional axis can be set to A, B, C, U, V, or W by using parameter 1020. Parameter No. 1020 is used to determine the name of each axis.

When this parameter is set to 0 or a character other than the valid characters is specified, an axis name from 1 to 8 is assigned by default.

In two-path control, the basic three axis names are fixed to X, Y, and Z for either path, but the name of an additional axis can be selected from A, B, C, U, V, and W by parameter 1020. Duplicate axis names cannot be used in the same path, but the same axis name can be used in different paths.

Limitations

- **Default axis name** When a default axis name (1 to 8) is used, operation in the MEM mode and MDI mode is disabled.
- **Duplicate axis names** If a duplicate axis name is specified in the parameter, operation is enabled only for the axis specified first.

NOTE

In two-path control, axis information displayed on the CRT screen, such as the current position, may contain an axis name with a suffix indicating the related path (X1, X2, etc). This is intended to provide a comprehensible indication of the path to which the axis belongs. The suffix cannot be used in a program ; the axis name should be specified as X, Y, Z, U, V, W, A, B, or C.

2.3 INCREMENT SYSTEM

The increment system consists of the least input increment (for input) and least command increment (for output). The least input increment is the least increment for programming the travel distance. The least command increment is the least increment for moving the tool on the machine. Both increments are represented in mm, inches, or deg.

Name of increment system	Least input increment	Least command increment	Maximum stroke
IS-B	0.001mm 0.0001inch 0.001deg	0.001mm 0.0001inch 0.001deg	99999.999mm 9999.9999inch 99999.999deg

Name of increment system	Least input increment	Least command increment	Maximum stroke
IS-C	0.0001mm 0.00001inch 0.0001deg	0.0001mm 0.00001inch 0.0001deg	9999.9999mm 999.99999inch 9999.9999deg

The least command increment is either metric or inch depending on the machine tool. Set metric or inch to the parameter INM (No.100#0). For selection between metric and inch for the least input increment, G code (G20 or G21) or a setting parameter selects it.

Combined use of the inch system and the metric system is not allowed. There are functions that cannot be used between axes with different unit systems (circular interpolation, cutter compensation, etc.). For the increment system, see the machine tool builder's manual.

2.4 MAXIMUM STROKE

Maximum stroke = Least command increment \times 99999999
See 2.3 Increment System.

Table 2.4(a) Maximum strokes

Increment system		Maximum stroke
IS-B	Metric machine system	\pm 99999.999 mm \pm 99999.999 deg
	Inch machine system	\pm 9999.9999 inch \pm 99999.999 deg
IS-C	Metric machine system	\pm 9999.9999 mm \pm 9999.9999 deg
	Inch machine system	\pm 999.99999 inch \pm 9999.9999 deg

NOTE

- 1 A command exceeding the maximum stroke cannot be specified.
- 2 The actual stroke depends on the machine tool.

3

PREPARATORY FUNCTION (G FUNCTION)

A number following address G determines the meaning of the command for the concerned block.

G codes are divided into the following two types.

Type	Meaning
One-shot G code	The G code is effective only in the block in which it is specified.
Modal G code	The G code is effective until another G code of the same group is specified.

(Example)

G01 and G00 are modal G codes in group 01.

```
G01X-;
  Z;
  X;
G00Z-; } G01 is effective in this range.
```

Explanations


1. When the clear state (bit 6 (CLR) of parameter No. 3402) is set at power-up or reset, the modal G codes are placed in the states described below.
 - (1) The modal G codes are placed in the states marked with  as indicated in Table 3.
 - (2) G20 and G21 remain unchanged when the clear state is set at power-up or reset.
 - (3) Which status G22 or G23 at power on is set by parameter G23 (No. 3402#7). However, G22 and G23 remain unchanged when the clear state is set at reset.
 - (4) The user can select G00 or G01 by setting bit 0 (G01) of parameter No. 3402.
 - (5) The user can select G90 or G91 by setting bit 3 (G91) of parameter No. 3402.
 - (6) The user can select G17, G18, or G19 by setting bit 1 (parameter G18) and bit 2 (parameter G19) of parameter No. 3402.
2. G codes other than G10 and G11 are one-shot G codes.
3. When a G code not listed in the G code list is specified, or a G code that has no corresponding option is specified, P/S alarm No. 010 is output.
4. Multiple G codes can be specified in the same block if each G code belongs to a different group. If multiple G codes that belong to the same group are specified in the same block, only the last G code specified is valid.
5. If a G code belonging to group 01 is specified in a canned cycle, the canned cycle is cancelled. This means that the same state set by specifying G80 is set. Note that the G codes in group 01 are not affected by a G code specifying a canned cycle.
6. G codes are indicated by group.
7. The group of G60 is switched according to the setting of the MDL bit (bit 0 of parameter 5431). (When the MDL bit is set to 0, the 00 group is selected. When the MDL bit is set to 1, the 01 group is selected.)

Table 3 G code list (1/3)

G code	Group	Function	
G00	01	Positioning	
G01		Linear interpolation	
G02		Circular interpolation/Helical interpolation CW	
G03		Circular interpolation/Helical interpolation CCW	
G02.2, G03.2		Involute interpolation	
G02.3, G03.3		Explanation interpolation	
G04	00	Dwell, Exact stop	
G05		High speed cycle machining	
G07		Hypothetical axis interpolation	
G07.1 (G107)		Cylindrical interpolation	
G08		Look-ahead control	
G09		Exact stop	
G10		Programmable data input	
G10.6		Tool retract & recover	
G11		Programmable data input mode cancel	
G12.1	25	Polar coordinate interpolation mode	
G13.1		Polar coordinate interpolation cancel mode	
G15	17	Polar coordinates command cancel	
G16		Polar coordinates command	
G17	02	XpYp plane selection	Xp: X axis or its parallel axis
G18		ZpXp plane selection	Yp: Y axis or its parallel axis
G19		YpZp plane selection	Zp: Z axis or its parallel axis
G20	06	Input in inch	
G21		Input in mm	
G22	04	Stored stroke check function on	
G23		Stored stroke check function off	
G25	24	Spindle speed fluctuation detection off	
G26		Spindle speed fluctuation detection on	
G27	00	Reference position return check	
G28		Return to reference position	
G29		Return from reference position	
G30		2nd, 3rd and 4th reference position return	
G30.1		Floating reference point return	
G31		Skip function	
G33		01	Thread cutting

Table 3 G code list (2/3)

G code	Group	Function
G37	00	Automatic tool length measurement
G39		Corner offset circular interpolation
G40	07	Cutter compensation cancel/Three dimensional compensation cancel
G41		Cutter compensation left/Three dimensional compensation
G42		Cutter compensation right
G40.1 (G150)	19	Normal direction control cancel mode
G41.1 (G151)		Normal direction control left side on
G42.1 (G152)		Normal direction control right side on
G43	08	Tool length compensation + direction
G44		Tool length compensation – direction
G45	00	Tool offset increase
G46		Tool offset decrease
G47		Tool offset double increase
G48		Tool offset double decrease
G49	08	Tool length compensation cancel
G50	11	Scaling cancel
G51		Scaling
G50.1	22	Programmable mirror image cancel
G51.1		Programmable mirror image
G52	00	Local coordinate system setting
G53		Machine coordinate system selection
G54	14	Workpiece coordinate system 1 selection
G54.1		Additional workpiece coordinate system selection
G55		Workpiece coordinate system 2 selection
G56		Workpiece coordinate system 3 selection
G57		Workpiece coordinate system 4 selection
G58		Workpiece coordinate system 5 selection
G59		Workpiece coordinate system 6 selection
G60	00	Single direction positioning
G61	15	Exact stop mode
G62		Automatic corner override
G63		Tapping mode
G64		Cutting mode

Table 3 G code list (3/3)

G code	Group	Function
G65	00	Macro call
G66	12	Macro modal call
G67		Macro modal call cancel
G68	16	Coordinate rotation/Three dimensional coordinate conversion
G69		Coordinate rotation cancel/Three dimensional coordinate conversion cancel
G73	09	Peck drilling cycle
G74		Counter tapping cycle
G75	01	Plunge grinding cycle (for grinding machine)
G76	09	Fine boring cycle
G77	01	Direct constant-dimension plunge grinding cycle(for grinding machine)
G78		Continuous-feed surface grinding cycle(for grinding machine)
G79		Intermittent-feed surface grinding cycle(for grinding machine)
G80	09	Canned cycle cancel/external operation function cancel
G81		Drilling cycle, spot boring cycle or external operation function
G82		Drilling cycle or counter boring cycle
G83		Peck drilling cycle
G84		Tapping cycle
G85		Boring cycle
G86		Boring cycle
G87		Back boring cycle
G88		Boring cycle
G89		Boring cycle
G90		03
G91	Increment command	
G92	00	Setting for work coordinate system or clamp at maximum spindle speed
G92.1		Workpiece coordinate system preset
G94	05	Feed per minute
G95		Feed per rotation
G96	13	Constant surface speed control
G97		Constant surface speed control cancel
G98	10	Return to initial point in canned cycle
G99		Return to R point in canned cycle
G160	20	In-feed control function cancel(for grinding machine)
G161		In-feed control function(for grinding machine)

4

INTERPOLATION FUNCTIONS



4.1 POSITIONING (G00)

The G00 command moves a tool to the position in the workpiece system specified with an absolute or an incremental command at a rapid traverse rate.

In the absolute command, coordinate value of the end point is programmed.

In the incremental command the distance the tool moves is programmed.

Format

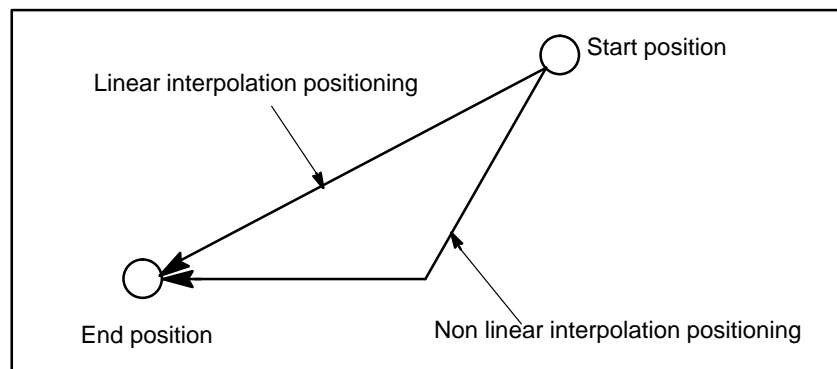
G00 IP_;

IP: For an absolute command, the coordinates of an end position, and for an incremental command, the distance the tool moves.

Explanations

Either of the following tool paths can be selected according to bit 1 of parameter LRP No. 1401.

- **Nonlinear interpolation positioning**
The tool is positioned with the rapid traverse rate for each axis separately. The tool path is normally straight.
- **Linear interpolation positioning**
The tool path is the same as in linear interpolation (G01). The tool is positioned within the shortest possible time at a speed that is not more than the rapid traverse rate for each axis.



The rapid traverse rate in G00 command is set to the parameter No. 1420 for each axis independently by the machine tool builder. In the positioning mode actuated by G00, the tool is accelerated to a predetermined speed at the start of a block and is decelerated at the end of a block. Execution proceeds to the next block after confirming the in-position.

“In-position ” means that the feed motor is within the specified range. This range is determined by the machine tool builder by setting to parameter (No. 1826).

In-position check for each block can be disabled by setting bit 5 (NCI) of parameter No.1601 accordingly.

Limitations

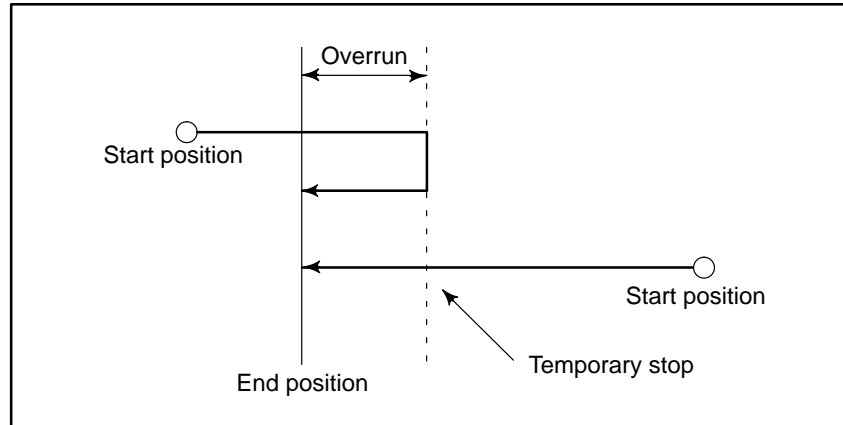
The rapid traverse rate cannot be specified in the address F.

Even if linear interpolation positioning is specified, nonlinear interpolation positioning is used in the following cases. Therefore, be careful to ensure that the tool does not foul the workpiece.

- G28 specifying positioning between the reference and intermediate positions.
- G53

4.2 SINGLE DIRECTION POSITIONING (G60)

For accurate positioning without play of the machine (backlash), final positioning from one direction is available.



Format

G60IP_;
IP : For an absolute command, the coordinates of an end position, and for an incremental command, the distance the tool moves.

Explanations

An overrun and a positioning direction are set by the parameter (No. 5440). Even when a commanded positioning direction coincides with that set by the parameter, the tool stops once before the end point. G60, which is a one-shot G-code, can be used as a modal G-code in group 01 by setting 1 to the parameter (No. 5431 bit 0 MDL). This setting can eliminate specifying a G60 command for every block. Other specifications are the same as those for a one-shot G60 command. When a one-shot G code is specified in the single direction positioning mode, the one-shot G command is effective like G codes in group 01.

Examples

When one-shot G60 commands are used.	When modal G60 command is used.
⋮	⋮
G90;	G90G60;
G60 X0Y0;	X0Y0;
G60 X100;	X100;
G60 Y100;	Y100;
G04 X10;	G04X10;
G00 X0Y0;	G00X0Y0;
⋮	⋮
⋮	⋮

} Single direction positioning

} Single direction positioning mode start

} Single direction positioning

} Dwell

} Single direction positioning mode cancel

Restrictions

- During canned cycle for drilling, no single direction positioning is effected in Z axis.
- No single direction positioning is effected in an axis for which no overrun has been set by the parameter.
- When the move distance 0 is commanded, the single direction positioning is not performed.
- The direction set to the parameter is not effected by mirror image.
- The single direction positioning does not apply to the shift motion in the canned cycles of G76 and G87.

4.3 LINEAR INTERPOLATION (G01)

Tools can move along a line

Format

G01 IP_F_;
IP:For an absolute command, the coordinates of an end point ,
 and for an incremental commnad, the distance the tool moves.
F_:Speed of tool feed (Feedrate)

Explanations

A tools move along a line to the specified position at the feedrate specified in F.

The feedrate specified in F is effective until a new value is specified. It need not be specified for each block.

The feedrate commanded by the F code is measured along the tool path. If the F code is not commanded, the feedrate is regarded as zero.

The feedrate of each axis direction is as follows.

G01 $\alpha\beta\gamma\zeta$ Ff ;

Feed rate of α axis direction : $F\alpha = \frac{\alpha}{L} \times f$

Feed rate of B axis direction : $F\beta = \frac{\beta}{L} \times f$

Feed rate of Γ axis direction : $F\gamma = \frac{\gamma}{L} \times f$

Feed rate of Z axis direction : $F\zeta = \frac{\zeta}{L} \times f$

$$L = \sqrt{\alpha^2 + \beta^2 + \gamma^2 + \zeta^2}$$

The feed rate of the rotary axis is commanded in the unit of deg/min (the unit is decimal point position).

When the straight line axis α (such as X, Y, or Z) and the rotating axis β (such as A, B, or C) are linearly interpolated, the feed rate is that in which the tangential feed rate in the α and β cartesian coordinate system is commanded by F(mm/min).

β -axis feedrate is obtained ; at first, the time required for distribution is calculated by using the above fromula, then the β -axis feedrate unit is changed to deg 1min.

A calculation example is as follows.

G91 G01 X20.0B40.0 F300.0 ;

This changes the unit of the C axis from 40.0 deg to 40mm with metric input. The time required for distribution is calculated as follows:

$$\frac{\sqrt{20^2 + 40^2}}{300} \doteq 0.14907 \text{ (min)}$$

The feed rate for the C axis is

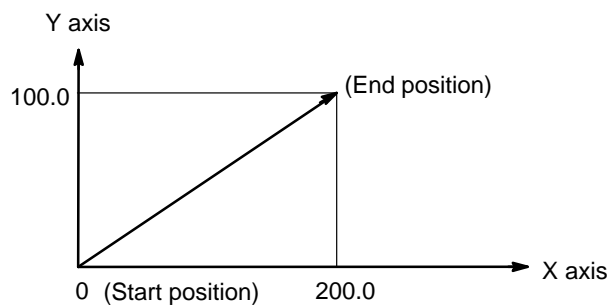
$$\frac{40}{0.14907} \doteq 268.3 \text{ deg/min}$$

In simultaneous 3 axes control, the feed rate is calculated the same way as in 2 axes control.

Examples

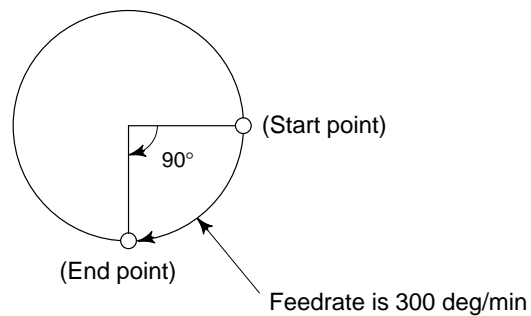
- Linear interpolation

(G91) G01X200.0Y100.0F200.0 ;



- Feedrate for the rotation axis

G91G01C-90.0 G300.0 ;Feed rate of 300deg/min



4.4 CIRCULAR INTERPOLATION (G02,G03)

The command below will move a tool along a circular arc.

Format

Arc in the XpYp plane	
$G17 \left\{ \begin{array}{l} G02 \\ G03 \end{array} \right\}$	$Xp_Yp_ \left\{ \begin{array}{l} I_ J_ \\ R_ \end{array} \right\} F_ ;$
Arc in the ZpXp plane	
$G18 \left\{ \begin{array}{l} G02 \\ G03 \end{array} \right\}$	$Xp_ p_ \left\{ \begin{array}{l} I_ K_ \\ R_ \end{array} \right\} F_$
Arc in the YpZp plane	
$G19 \left\{ \begin{array}{l} G02 \\ G03 \end{array} \right\}$	$Yp_ Zp_ \left\{ \begin{array}{l} J_ K_ \\ R_ \end{array} \right\} F_$

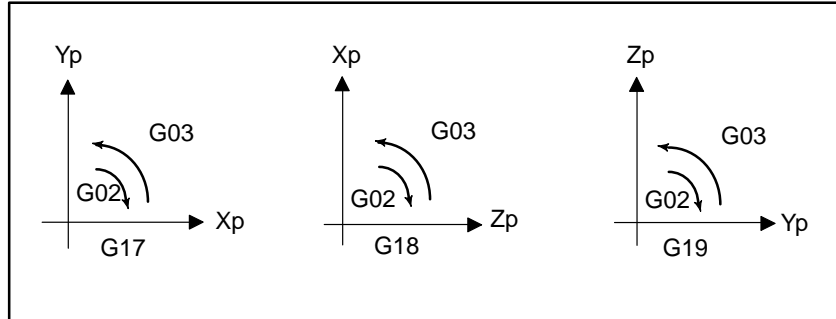
Table.4.4 Description of the Command Format

Command	Description
G17	Specification of arc on XpYp plane
G18	Specification of arc on ZpXp plane
G19	Specification of arc on YpZp plane
G02	Circular Interpolation Clockwise direction (CW)
G03	Circular Interpolation Counterclockwise direction (CCW)
Xp_	Command values of X axis or its parallel axis (set by parameter No. 1022)
Yp_	Command values of Y axis or its parallel axis (set by parameter No. 1022)
Zp_	Command values of Z axis or its parallel axis (set by parameter No. 1022)
I_	Xp axis distance from the start point to the center of an arc with sign
J_	Yp axis distance from the start point to the center of an arc with sign
k_	Zp axis distance from the start point to the center of an arc with sign
R_	Arc radius (with sign)
F_	Feedrate along the arc

Explanations

• **Direction of the circular interpolation**

“Clockwise”(G02) and “counterclockwise”(G03) on the $X_p Y_p$ plane ($Z_p X_p$ plane or $Y_p Z_p$ plane) are defined when the $X_p Y_p$ plane is viewed in the positive-to-negative direction of the Z_p axis (Y_p axis or X_p axis, respectively) in the Cartesian coordinate system. See the figure below.



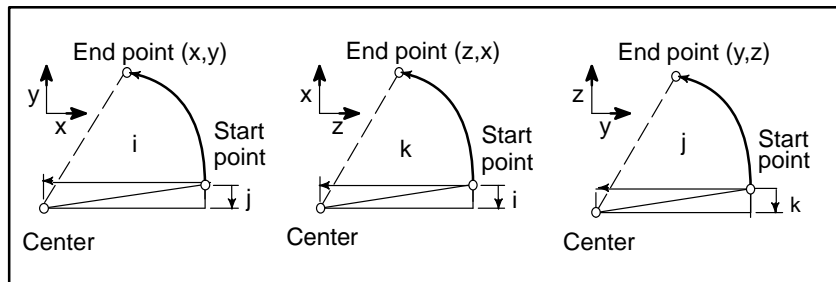
• **Distance moved on an arc**

The end point of an arc is specified by address X_p , Y_p or Z_p , and is expressed as an absolute or incremental value according to G90 or G91. For the incremental value, the distance of the end point which is viewed from the start point of the arc is specified.

• **Distance from the start point to the center of arc**

The arc center is specified by addresses I, J, and K for the X_p , Y_p , and Z_p axes, respectively. The numerical value following I, J, or K, however, is a vector component in which the arc center is seen from the start point, and is always specified as an incremental value irrespective of G90 and G91, as shown below.

I, J, and K must be signed according to the direction.



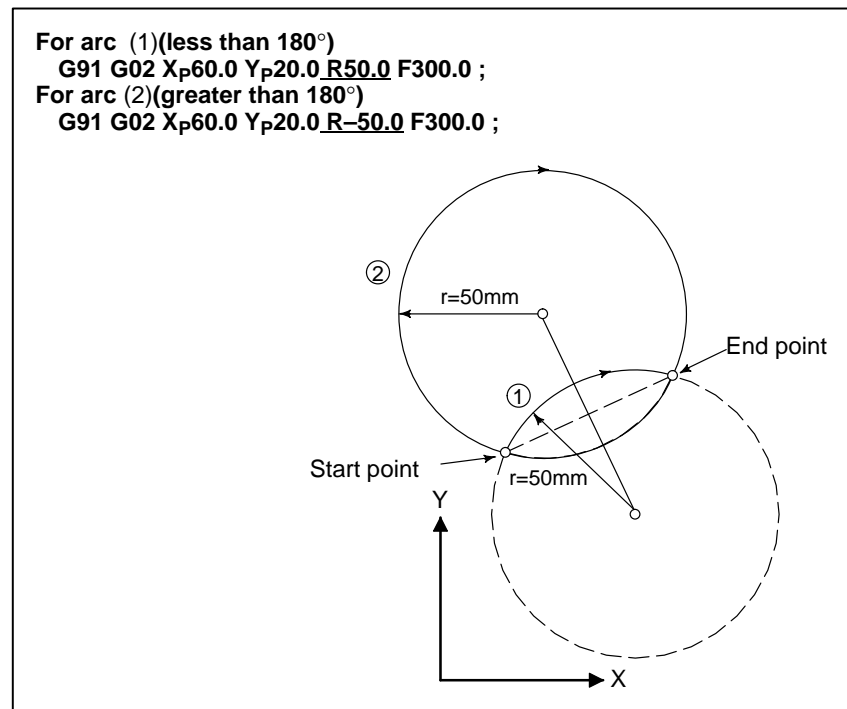
I0,J0, and K0 can be omitted. When X_p , Y_p , and Z_p are omitted (the end point is the same as the start point) and the center is specified with I, J, and K, a 360° arc (circle) is specified.

G021; Command for a circle

If the difference between the radius at the start point and that at the end point exceeds the permitted value in a parameter (No.3410), an P/S alarm (No.020) occurs.

- **Arc radius**

The distance between an arc and the center of a circle that contains the arc can be specified using the radius, R, of the circle instead of I, J, and K. In this case, one arc is less than 180° , and the other is more than 180° are considered. When an arc exceeding 180° is commanded, the radius must be specified with a negative value. If X_p , Y_p , and Z_p are all omitted, if the end point is located at the same position as the start point and when R is used, an arc of 0° is programmed
G02R ; (The cutter does not move.)



- **Feedrate**

The feedrate in circular interpolation is equal to the feed rate specified by the F code, and the feedrate along the arc (the tangential feedrate of the arc) is controlled to be the specified feedrate.

The error between the specified feedrate and the actual tool feedrate is $\pm 2\%$ or less. However, this feed rate is measured along the arc after the cutter compensation is applied

Restrictions

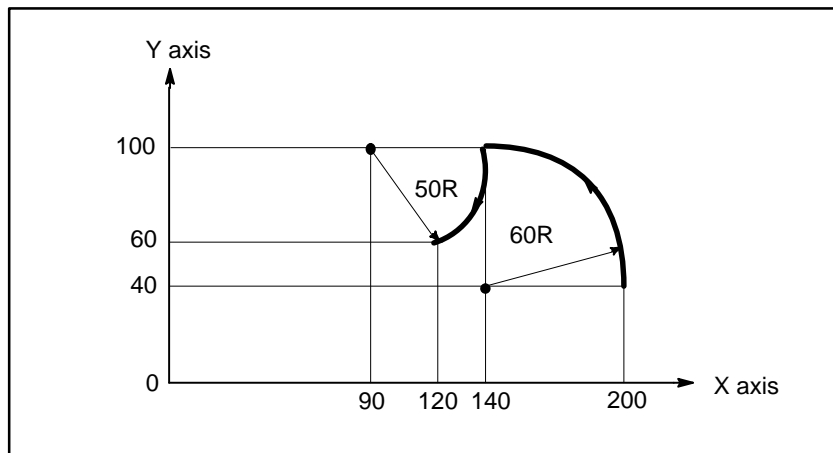
If I, J, K, and R addresses are specified simultaneously, the arc specified by address R takes precedence and the other are ignored.

If an axis not comprising the specified plane is commanded, an alarm is displayed.

For example, if axis U is specified as a parallel axis to X axis when plane XY is specified, an P/S alarm (No.028) is displayed.

When an arc having a center angle approaching 180° is specified, the calculated center coordinates may contain an error. In such a case, specify the center of the arc with I, J, and K.

Examples



The above tool path can be programmed as follows ;

(1) In absolute programming

G92X200.0 Y40.0 Z0 ;

G90 G03 X140.0 Y100.0R60.0 F300.;

G02 X120.0 Y60.0R50.0 ;

or

G92X200.0 Y40.0Z0 ;

G90 G03 X140.0 Y100.0I-60.0 F300.;

G02 X120.0 Y60.0I-50.0 ;

(2) In incremental programming

G91 G03 X-60.0 Y60.0 R60.0 F300.;

G02 X-20.0 Y-40.0 R50.0 ;

or

G91 G03 X-60.0 Y60.0 I-60.0 F300. ;

G02 X-20.0 Y-40.0 I-50.0 ;

4.5 HELICAL INTERPOLATION (G02,G03)

Format

Synchronously with arc of XpYp plane

$$G17 \left\{ \begin{array}{l} G02 \\ G03 \end{array} \right\} Xp_Yp_ \left\{ \begin{array}{l} I_J_ \\ R_ \end{array} \right\} \alpha_(\beta_)F_;$$

Synchronously with arc of ZpXp plane

$$G18 \left\{ \begin{array}{l} G02 \\ G03 \end{array} \right\} Xp_Zp_ \left\{ \begin{array}{l} I_K_ \\ R_ \end{array} \right\} \alpha_(\beta_)F_;$$

Synchronously with arc of YpZp plane

$$G19 \left\{ \begin{array}{l} G02 \\ G03 \end{array} \right\} Yp_Zp_ \left\{ \begin{array}{l} J_K_ \\ R_ \end{array} \right\} \alpha_(\beta_)F_;$$

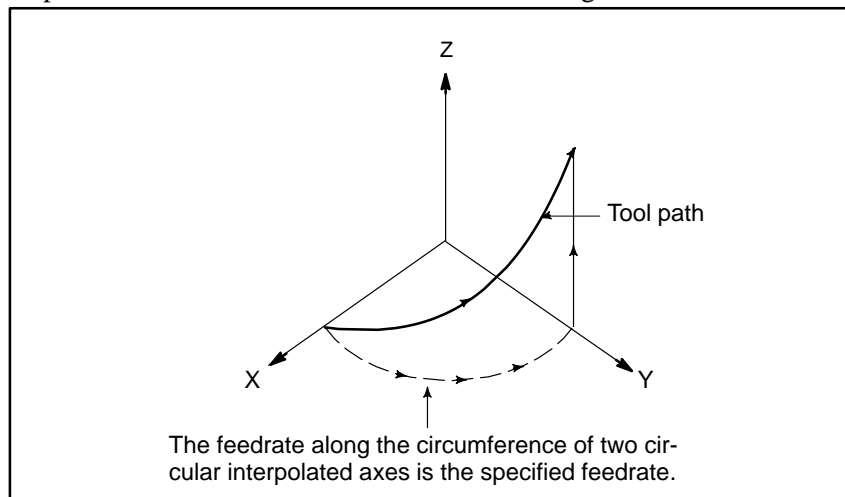
α, β : Any one axis where circular interpolation is not applied.
Up to two other axes can be specified.

Explanations

The command method is to simply or secondary add a move command axis which is not circular interpolation axes. An F command specifies a feed rate along a circular arc. Therefore, the feed rate of the linear axis is as follows:

$$F_x \frac{\text{Length of linear axis}}{\text{Length of circular arc}}$$

Determine the feed rate so the linear axis feed rate does not exceed any of the various limit values. Bit 0 (HFC) of parameter No. 1404 can be used to prevent the linear axis feedrate from exceeding various limit values.



Restrictions

- Cutter compensation is applied only for a circular arc.
- Tool offset and tool length compensation cannot be used in a block in which a helical interpolation is commanded.

4.6 HELICAL INTERPOLATION B (G02, G03)

Format

Helical interpolation B moves the tool in a helical manner. This interpolation can be executed by specifying the circular interpolation command together with up to four additional axes in simple high-precision contour control mode (see II-19.6).

With an arc in the XpYp plane

$$G17 \left\{ \begin{array}{l} G02 \\ G03 \end{array} \right\} Xp_Yp_ \left\{ \begin{array}{l} I_J_ \\ R_ \end{array} \right\} \alpha_ \beta_ \gamma_ \delta_ F_;$$

With an arc in the ZpXp plane

$$G18 \left\{ \begin{array}{l} G02 \\ G03 \end{array} \right\} Xp_Zp_ \left\{ \begin{array}{l} I_K_ \\ R_ \end{array} \right\} \alpha_ \beta_ \gamma_ \delta_ F_;$$

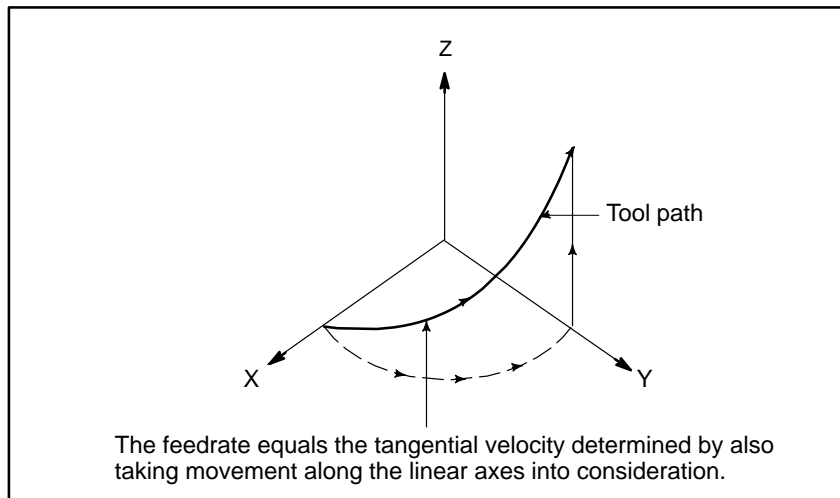
With an arc in the YpZp plane

$$G19 \left\{ \begin{array}{l} G02 \\ G03 \end{array} \right\} Yp_Zp_ \left\{ \begin{array}{l} J_K_ \\ R_ \end{array} \right\} \alpha_ \beta_ \gamma_ \delta_ F_;$$

$\alpha, \beta, \gamma, \delta$: Any axis to which circular interpolation is not applied.
Up to four axes can be specified.

Explanations

Basically, the command can be specified by adding two movement axes to a standard helical interpolation command (see II-4.5). Address F should be followed by a tangential velocity, which has been determined by also taking movement along the linear axes into consideration.



Limitations

- The command of helical interpolation B can be specified only in simple high-precision contour control mode.
- Cutter compensation is applied only to an arc.
- In a block containing the helical interpolation command, the tool offset command or tool length compensation command cannot be specified.

4.7 SPIRAL INTERPOLATION, CONICAL INTERPOLATION (G02, G03)

Format

- Spiral interpolation

Spiral interpolation is enabled by specifying the circular interpolation command together with a desired number of revolutions or a desired increment (decrement) for the radius per revolution.

Conical interpolation is enabled by specifying the spiral interpolation command together with one or two additional axes of movement, as well as a desired increment (decrement) for the position along the additional axes per spiral revolution.

XpYp plane

$$G17 \left\{ \begin{array}{l} G02 \\ G03 \end{array} \right\} X_Y_I_J_Q_L_F_;$$

ZpXp plane

$$G18 \left\{ \begin{array}{l} G02 \\ G03 \end{array} \right\} Z_X_K_I_Q_L_F_;$$

YpZp plane

$$G19 \left\{ \begin{array}{l} G02 \\ G03 \end{array} \right\} Y_Z_J_K_Q_L_F_;$$

X,Y,Z Coordinates of the end point

L Number of revolutions (positive value without a decimal point)(*1)

Q Radius increment or decrement per spiral revolution(*1)

I,J,K Signed distance from the start point to the center
(same as the distance specified for circular interpolation)

F Feedrate

(*1) Either the number of revolutions (L) or the radius increment or decrement (Q) can be omitted. When L is omitted, the number of revolutions is automatically calculated from the distance between the current position and the center, the position of the end point, and the radius increment or decrement. When Q is omitted, the radius increment or decrement is automatically calculated from the distance between the current position and the center, the position of the end point, and the number of revolutions. If both L and Q are specified but their values contradict, Q takes precedence. Generally, either L or Q should be specified. The L value must be a positive value without a decimal point. To specify four revolutions plus 90°, for example, round the number of revolutions up to five and specify L5.

- Conical interpolation

XpYp plane

$$G17 \left\{ \begin{array}{l} G02 \\ G03 \end{array} \right\} X_Y_I_J_Q_L_F_;$$

ZpXp plane

$$G18 \left\{ \begin{array}{l} G02 \\ G03 \end{array} \right\} Z_X_K_I_Q_L_F_;$$

YpZp plane

$$G19 \left\{ \begin{array}{l} G02 \\ G03 \end{array} \right\} Y_Z_J_K_Q_L_F_;$$

X,Y,Z Coordinates of the end point

L Number of revolutions (positive value without a decimal point)(*1)

Q (Radius increment or decrement per spiral revolution)(*1)

I,J,K Two of the three values represent a signed vector from the start point to the center. The remaining value is a height increment or decrement per spiral revolution in conical interpolation(*1)(*2)

When the XpYp plane is selected:

The I and J values represent a signed vector from the start point to the center.

The K value represents a height increment or decrement per spiral revolution.

When the ZpXp plane is selected:

The K and I values represent a signed vector from the start point to the center.

The J value represents a height increment or decrement per spiral revolution.

When the YpZp plane is selected:

The J and K values represent a signed vector from the start point to the center.

The I value represents a height increment or decrement per spiral revolution.

F Feedrate (determined by taking movement along the linear axes into consideration)

(*1) One of the height increment/decrement (I, J, K), radius increment/decrement (Q), and the number of revolutions (L) must be specified. The other two items can be omitted.

· Sample command for the XpYp plane

$$G17 \left\{ \begin{array}{l} G02 \\ G03 \end{array} \right\} X_Y_I_J_Z_; \left\{ \begin{array}{l} K_ \\ Q_ \\ L_ \end{array} \right\} F_;$$

If both L and Q are specified, but their values contradict, Q takes precedence. If both L and a height increment or decrement are specified, but their values contradict, the height increment or decrement takes precedence. If both Q and a height increment or decrement are specified, but their values contradict, Q takes precedence. The L value must be a positive value without a decimal point. To specify four revolutions plus 90°, for example, round the number of revolutions up to five and specify L5.

(*2) When two axes (of height) other than plane axes are specified, the height increment or decrement (I, J, K) cannot be specified. Specify either a desired radius increment or decrement (Q) or a desired number of revolutions (L).

Explanations

- **Function of spiral interpolation**

Spiral interpolation in the XY plane is defined as follows:

$$(X - X_0)^2 + (Y - Y_0)^2 = (R + Q')^2$$

X_0 : X coordinate of the center

Y_0 : Y coordinate of the center

R : Radius at the beginning of spiral interpolation

Q' : Variation in radius

When the programmed command is assigned to this function, the following expression is obtained:

$$(X - X_S - I)^2 + (Y - Y_S - J)^2 = \left(R + \left(L' + \frac{\theta}{360} \right) Q \right)^2$$

where

X_S : X coordinate of the start point

Y_S : Y coordinate of the start point

I : X coordinate of the vector from the start point to the center

J : Y coordinate of the vector from the start point to the center

R : Radius at the beginning of spiral interpolation

Q : Radius increment or decrement per spiral revolution

L' : (Current number of revolutions) – 1

θ : Angle between the start point and the current position (degrees)

- **Movement between blocks**

Block overlap between a spiral/conical interpolation block and other blocks is performed only in simple high-precision contour control mode (see II-19.6). In other modes, the movement is decelerated and stopped in the block before the spiral/conical interpolation block, after which interpolation starts. After completion of the spiral/conical interpolation block, the movement is decelerated and stopped, then the next block is executed.

- **Controlled axes**

For conical interpolation, two axes of a plane and two additional axes, that is, four axes in total, can be specified. A rotation axis can be specified as the additional axis.

- **Cutter compensation C**

The spiral or conical interpolation command can be programmed in cutter compensation C mode. At the start and end points of the block, a virtual circle around the center of the spiral interpolation is drawn. Cutter compensation is performed along the virtual circle, then spiral interpolation is performed about the result of the cutter compensation. When both the start point and end point are at the center, no virtual circle can be drawn. If drawing is attempted, P/S alarm No. 5124 is issued.

- **Feedrate clamping by arc radius**

During spiral interpolation, the function for clamping the feedrate by arc radius (parameters 1730 to 1732) is enabled. The feedrate may decrease as the tool approaches the center of the spiral.

- **Dry run**

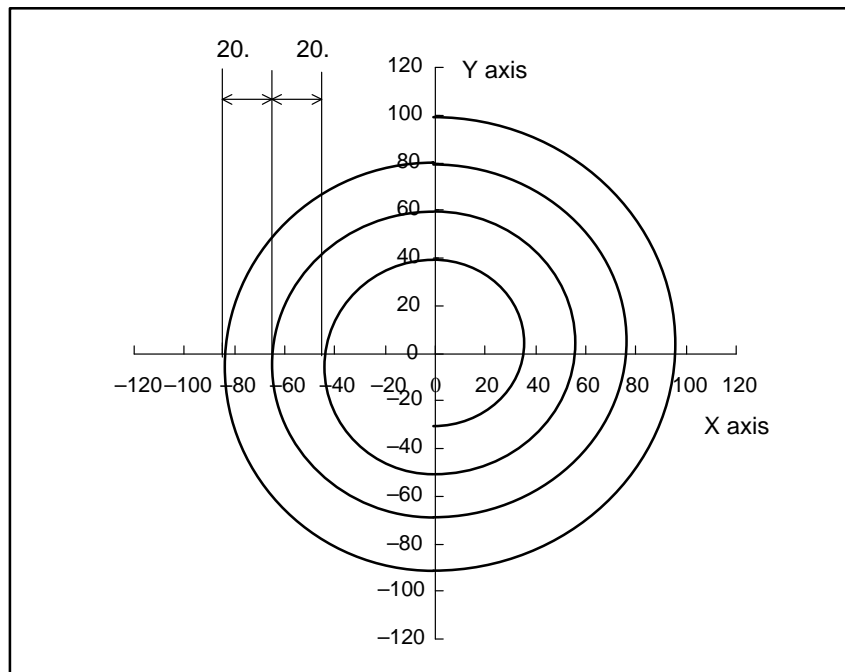
When the dry run signal is inverted from 0 to 1 or from 1 to 0 during movement along an axis, the movement is accelerated or decelerated to the desired speed without first reducing the speed to zero.

Limitations

- **Radius** In spiral or conical interpolation, R for specifying an arc radius cannot be specified.
- **Corner deceleration** Corner deceleration between the spiral/conical interpolation block and other blocks can be performed only in simple high-precision contour control mode.
- **Feed functions** The functions of feed per rotation, inverse time feed, F command with one digit, and automatic corner override cannot be used.
- **Program restart** A program including spiral or conical interpolation cannot be restarted.
- **Retrace** A program including spiral or conical interpolation cannot be retraced.

Examples

- **Spiral interpolation**



The path indicated above is programmed with absolute and incremental values, as shown below:

This sample path has the following values:

- Start point : (0, 100.0)
- End point (X, Y) : (0, -30.0)
- Distance to the center (I, J) : (0, -100.0)
- Radius increment or decrement (Q) : -20.0
- Number of revolutions (L) : 4.

(1) With absolute values, the path is programmed as follows:

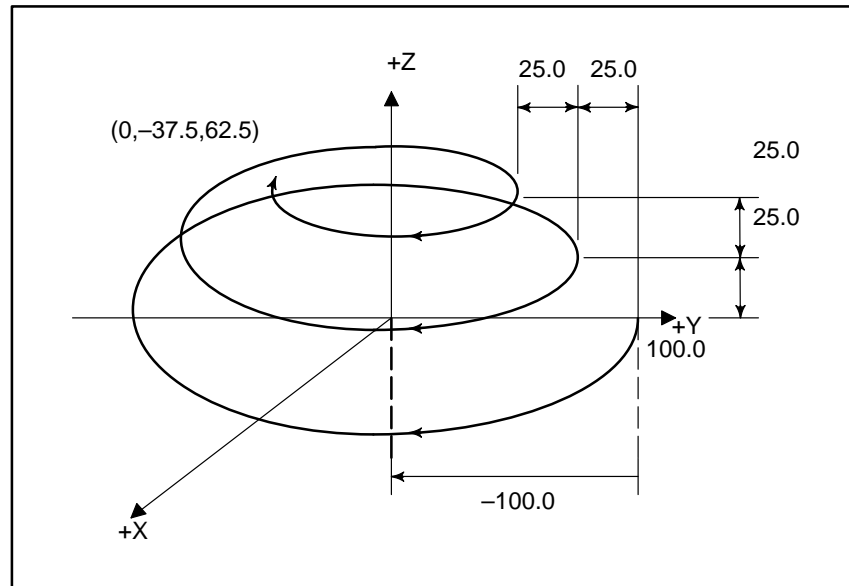
```
G90 G02 X0 Y-30.0 I0 J-100.0 ( Q-20.0 ) F300;
                          L4
```

(2) With incremental values, the path is programmed as follows:

```
G91 G02 X0 Y-130.0 I0 J-100.0 ( Q-20.0 ) F300;
                          L4
```

(Either the Q or L setting can be omitted.)

• Conical interpolation



The sample path shown above is programmed with absolute and incremental values as follows:

This sample path has the following values:

- Start point : (0, 100.0, 0)
- End point (X, Y, Z) : (0, -37.5, 62.5)
- Distance to the center (I, J) : (0, -100.0)
- Radius increment or decrement (Q) : -25.0
- Height increment or decrement (K) : 25.0
- Number of revolutions (L) : 3

(1) With absolute values, the path is programmed as follows:

$$G90 G02 X0 Y-37.5 Z62.5 I0 J-100.0 \begin{pmatrix} K25.0 \\ Q-25.0 \\ L3 \end{pmatrix} F300;$$

(2) With incremental values, the path is programmed as follows:

$$G91 G02 X0 Y-137.5 Z62.5 I0 J-100.0 \begin{pmatrix} K25.0 \\ Q-25.0 \\ L3 \end{pmatrix} F300;$$

4.8 POLAR COORDINATE INTERPOLATION (G12.1,G13.1)

Polar coordinate interpolation is a function that exercises contour control in converting a command programmed in a Cartesian coordinate system to the movement of a linear axis (movement of a tool) and the movement of a rotary axis (rotation of a workpiece). This function is useful for grinding a cam shaft.

Format

G12.1 ;	}	Starts polar coordinate interpolation mode (enables polar coordinate interpolation) Specify linear or circular interpolation using coordinates in a Cartesian coordinate system consisting of a linear axis and rotary axis (virtual axis).
G13.1 ;		
Polar coordinate interpolation mode is cancelled (for not performing polar coordinate interpolation)		
Specify G12.1 and G13.1 in Separate Blocks.		

Explanations

- **Polar coordinate interpolation plane**

G12.1 starts the polar coordinate interpolation mode and selects a polar coordinate interpolation plane (Fig. 4.8 (a)). Polar coordinate interpolation is performed on this plane.

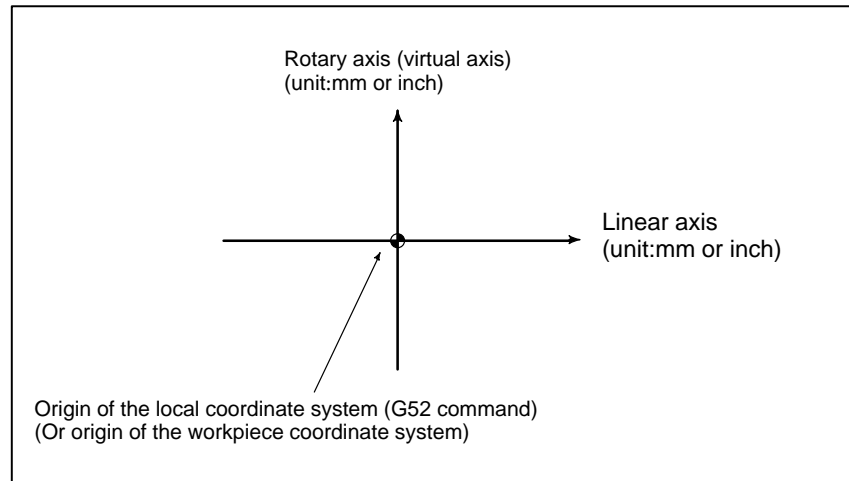


Fig4.8 (a) Polar coordinate interpolation plane.

When the power is turned on or the system is reset, polar coordinate interpolation is canceled (G13.1).

The linear and rotation axes for polar coordinate interpolation must be set in parameters (No. 5460 and 5461) beforehand.

CAUTION

The plane used before G12.1 is specified (plane selected by G17, G18, or G19) is canceled. It is restored when G13.1 (canceling polar coordinate interpolation) is specified. When the system is reset, polar coordinate interpolation is canceled and the plane specified by G17, G18, or G19 is used.

- **Distance moved and feedrate for polar coordinate interpolation**

The unit for coordinates on the hypothetical axis is the same as the unit for the linear axis (mm/inch)

The unit for the feedrate is mm/min or inch/min

- **G codes which can be specified in the polar coordinate interpolation mode**

In the polar coordinate interpolation mode, program commands are specified with Cartesian coordinates on the polar coordinate interpolation plane. The axis address for the rotation axis is used as the axis address for the second axis (virtual axis) in the plane. Whether a diameter or radius is specified for the first axis in the plane is the same as for the rotation axis regardless of the specification for the first axis in the plane. The virtual axis is at coordinate 0 immediately after G12.1 is specified. Polar interpolation is started assuming the angle of 0 for the position of the tool when G12.1 is specified.

Specify the feedrate as a speed (relative speed between the workpiece and tool) tangential to the polar coordinate interpolation plane (Cartesian coordinate system) using F.

G01 Linear interpolation

G02, G03 Circular interpolation

G04 Dwell, Exact stop

G40, G41, G42 . . . Cutter compensation

(Polar coordinate interpolation is applied to the path after cutter compensation.)

G65, G66, G67 . . . Custom macro command

G90, G91 Absolute command, incremental command

G94, G95 Feed per minute, feed per revolution

- **Circular interpolation in the polar coordinate plane**

The addresses for specifying the radius of an arc for circular interpolation (G02 or G03) in the polar coordinate interpolation plane depend on the first axis in the plane (linear axis).

- I and J in the X_p - Y_p plane when the linear axis is the X-axis or an axis parallel to the X-axis.

- J and K in the Y_p - Z_p plane when the linear axis is the Y-axis or an axis parallel to the Y-axis.

- K and I in the Z_p - X_p plane when the linear axis is the Z-axis or an axis parallel to the Z-axis.

The radius of an arc can be specified also with an R command.

- **Movement along axes not in the polar coordinate interpolation plane in the polar coordinate interpolation mode**

The tool moves along such axes normally, independent of polar coordinate interpolation.

- **Current position display in the polar coordinate interpolation mode**

Actual coordinates are displayed. However, the remaining distance to move in a block is displayed based on the coordinates in the polar coordinate interpolation plane (Cartesian coordinates).

Limitations

- **Coordinate system for the polar coordinate interpolation**

Before G12.1 is specified, a local coordinate system (or workpiece coordinate system) where the center of the rotary axis is the origin of the coordinate system must be set. In the G12.1 mode, the coordinate system must not be changed (G92, G52, G53, relative coordinate reset, G54 through G59, etc.).

- **Tool offset command**

The polar coordinate interpolation mode cannot be started or terminated (G12.1 or G13.1) in the tool offset mode (G41 or G42). G12.1 or G13.1 must be specified in the tool offset canceled mode (G40).

- **Tool length offset command**

Tool length offset must be specified in the polar coordinate interpolation cancel mode before G12.1 is specified. It cannot be specified in the polar coordinate interpolation mode. Furthermore, no offset values can be changed in the polar coordinate interpolation mode.

- **Tool offset command**

A tool offset must be specified before the G12.1 mode is set. No offset can be changed in the G12.1 mode.

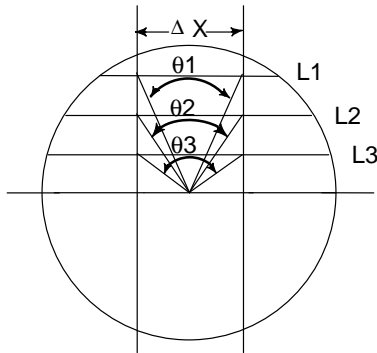
- **Program restart**

For a block in the G12.1 mode, the program cannot be restarted.

- **Cutting feedrate for the rotation axis**

Polar coordinate interpolation converts the tool movement for a figure programmed in a Cartesian coordinate system to the tool movement in the rotation axis (C-axis) and the linear axis (X-axis). When the tool moves closer to the center of the workpiece, the C-axis component of the feedrate becomes larger and may exceed the maximum cutting feedrate for the C-axis (set in parameter (No. 1422)), causing an alarm (see the figure below). To prevent the C-axis component from exceeding the maximum cutting feedrate for the C-axis, reduce the feedrate specified with address F or create a program so that the tool (center of the tool when cutter compensation is applied) does not move close to the center of the workpiece.

WARNING



Consider lines L1, L2, and L3. ΔX is the distance the tool moves per time unit at the feedrate specified with address F in the Cartesian coordinate system. As the tool moves from L1 to L2 to L3, the angle at which the tool moves per time unit corresponding to ΔX in the Cartesian coordinate system increases from θ_1 to θ_2 to θ_3 .

In other words, the C-axis component of the feedrate becomes larger as the tool moves closer to the center of the workpiece. The C component of the feedrate may exceed the maximum cutting feedrate for the C-axis because the tool movement in the Cartesian coordinate system has been converted to the tool movement for the C-axis and the X-axis.

L :Distance (in mm) between the tool center and workpiece center when the tool center is the nearest to the workpiece center

R :Maximum cutting feedrate (deg/min) of the C axis

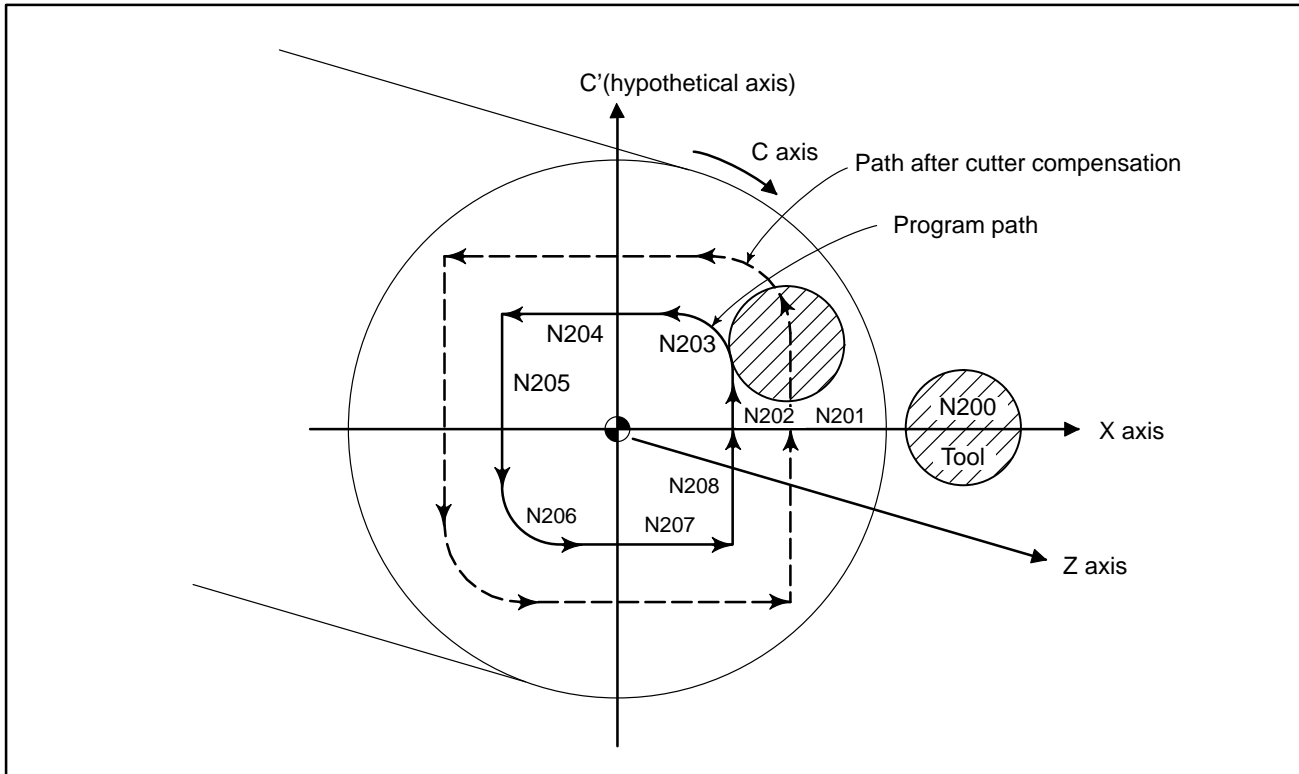
Then, a speed specifiable with address F in polar coordinate interpolation can be given by the formula below. Specify a speed allowed by the formula. The formula provides a theoretical value; in practice, a value slightly smaller than a theoretical value may need to be used due to a calculation error.

$$F < L \times R \times \frac{\pi}{180} \text{ (mm/min)}$$

Examples

Example of Polar Coordinate Interpolation Program

Based on X Axis(Linear Axis) and C Axis (Rotary Axis)



```

O0001 ;
  ⋮
N010 T0101
  ⋮
N0100 G90 G00 X60.0 C0 Z_ ;   Positioning to start position
N0200 G12.1 ;                 Start of polar coordinate interpolation
N0201 G42 G01 X20.0 F_ ;
N0202 C10.0 ;
N0203 G03 X10.0 C20.0 R10.0 ;
N0204 G01 X-20.0 ;
N0205 C-10.0 ;
N0206 G03 X-10.0 C-20.0 I10.0 J0 ;
N0207 G01 X20.0 ;
N0208 C0 ;
N0209 G40 X60.0 ;
N0210 G13.1 ;                 Cancellation of polar coordinate interpolation
N0300 Z_ ;
N0400 X_ C_ ;
  ⋮
N0900M30 ;
    
```

} Geometry program
(program based on cartesian coordinates on X-C' plane)

4.9 CYLINDRICAL INTERPOLATION (G07.1)

The amount of travel of a rotary axis specified by an angle is once internally converted to a distance of a linear axis along the outer surface so that linear interpolation or circular interpolation can be performed with another axis. After interpolation, such a distance is converted back to the amount of travel of the rotary axis.

The cylindrical interpolation function allows the side of a cylinder to be developed for programming. So programs such as a program for cylindrical cam grooving can be created very easily.

Format

**G07.1IP r ; Starts the cylindrical interpolation mode
(enables cylindrical interpolation).**

⋮

G07.1IP 0 ; The cylindrical interpolation mode is cancelled.

IP: An address for the rotation axis

r : The radius of the cylinder

**Specify G07.1 IP r ; and G07.1IP 0; in separate blocks.
G107 can be used instead of G07.1.**

Explanations

- **Plane selection
(G17, G18, G19)**

Use parameter (No. 1022) to specify whether the rotation axis is the X-, Y-, or Z-axis, or an axis parallel to one of these axes. Specify the G code to select a plane for which the rotation axis is the specified linear axis.

For example, when the rotation axis is an axis parallel to the X-axis, G17 must specify an Xp-Yp plane, which is a plane defined by the rotation axis and the Y-axis or an axis parallel to the Y-axis.

Only one rotation axis can be set for cylindrical interpolation.

- **Feedrate**

A feedrate specified in the cylindrical interpolation mode is a speed on the developed cylindrical surface.

- **Circular interpolation
(G02,G03)**

In the cylindrical interpolation mode, circular interpolation is possible with the rotation axis and another linear axis. Radius R is used in commands in the same way as described in II-4.4.

The unit for a radius is not degrees but millimeters (for metric input) or inches (for inch input).

< Example Circular interpolation between the Z axis and C axis >

For the C axis of parameter (No.1022), 5 (axis parallel with the X axis) is to be set. In this case, the command for circular interpolation is

G18 Z__C__;

G02 (G03) Z__C__R__;

For the C axis of parameter (No.1022), 6 (axis parallel with the Y axis) may be specified instead. In this case, however, the command for circular interpolation is

G19 C__Z__;

G02 (G03) Z__C__R__;

- **Tool offset**

To perform tool offset in the cylindrical interpolation mode, cancel any ongoing cutter compensation mode before entering the cylindrical interpolation mode. Then, start and terminate tool offset within the cylindrical interpolation mode.

- **Cylindrical interpolation accuracy**

In the cylindrical interpolation mode, the amount of travel of a rotary axis specified by an angle is once internally converted to a distance of a linear axis on the outer surface so that linear interpolation or circular interpolation can be performed with another axis. After interpolation, such a distance is converted back to an angle. For this conversion, the amount of travel is rounded to a least input increment.

So when the radius of a cylinder is small, the actual amount of travel can differ from a specified amount of travel. Note, however, that such an error is not accumulative.

If manual operation is performed in the cylindrical interpolation mode with manual absolute on, an error can occur for the reason described above.

$$\text{The actual amount of travel} = \left[\frac{\text{MOTION REV}}{2 \times 2\pi R} \left[\times \text{Specified value} \times \frac{2 \times 2\pi R}{\text{MOTION REV}} \right] \right]$$

MOTION REV : The amount of travel per rotation of the rotation axis (Setting value of parameter No. 1260)

R : Workpiece radius

$\left[\right]$: Rounded to the least input increment

Limitations

- **Arc radius specification in the cylindrical interpolation mode**

In the cylindrical interpolation mode, an arc radius cannot be specified with word address I, J, or K.

- **Circular interpolation and cutter compensation**

If the cylindrical interpolation mode is started when cutter compensation is already applied, circular interpolation is not correctly performed in the cylindrical interpolation mode.

- **Positioning**

In the cylindrical interpolation mode, positioning operations (including those that produce rapid traverse cycles such as G28, G53, G73, G74, G76, G80 through G89) cannot be specified. Before positioning can be specified, the cylindrical interpolation mode must be cancelled. Cylindrical interpolation (G07.1) cannot be performed in the positioning mode (G00).

- **Coordinate system setting**

In the cylindrical interpolation mode, a workpiece coordinate system (G92, G54 through G59) or local coordinate system (G52) cannot be specified.

- **Cylindrical interpolation mode setting**

In the cylindrical interpolation mode, the cylindrical interpolation mode cannot be reset. The cylindrical interpolation mode must be cancelled before the cylindrical interpolation mode can be reset.

- **Tool offset**

A tool offset must be specified before the cylindrical interpolation mode is set. No offset can be changed in the cylindrical interpolation mode.

- **Index table indexing function**

Cylindrical interpolation cannot be specified when the index table index function is being used.

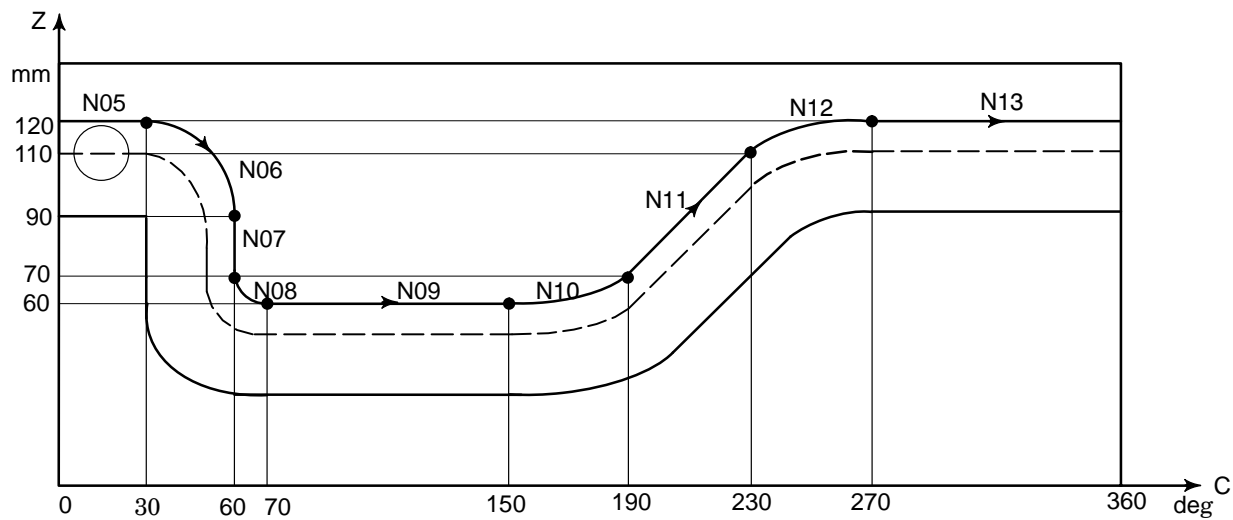
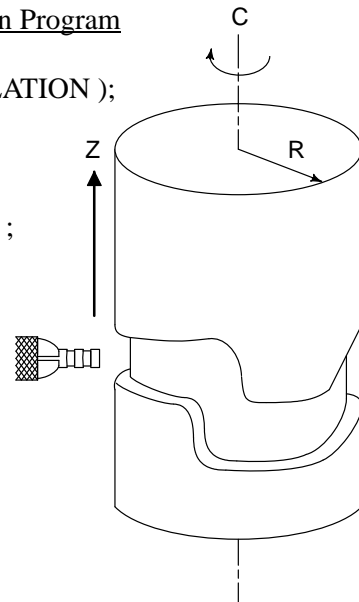
Examples

Example of a Cylindrical Interpolation Program

```

O0001 (CYLINDRICAL INTERPOLATION);
N01 G00 G90 Z100.0 C0;
N02 G01 G91 G18 Z0 C0;
N03 G07.1 C57299;
N04 G90 G01 G42 Z120.0 D01 F250;
N05 C30.0;
N06 G02 Z90.0 C60.0 R30.0;
N07 G01 Z70.0;
N08 G03 Z60.0 C70.0 R10.0;
N09 G01 C150.0;
N10 G03 Z70.0 C190.0 R75.0;
N11 G01 Z110.0 C230.0;
N12 G02 Z120.0 C270.0 R75.0;
N13 G01 C360.0;
N14 G40 Z100.0;
N15 G07.1 C0;
N16 M30;

```



4.10 INVOLUTE INTERPOLATION (G02.2, G03.2)

Involute curve machining can be performed by using involute interpolation. Involute interpolation ensures continuous pulse distribution even in high-speed operation in small blocks, thus enabling smooth and high-speed machining. Furthermore, machining tapes can be created easily and efficiently, reducing the required length of tape.

Format

Involute interpolation on the X–Y plane

G17 G02.2 X_Y I J R F_;

G17 G03.2 X_Y I J R F_;

Involute interpolation on the Z–X plane

G18 G02.2 Z_X K I R F_;

G18 G03.2 Z_X K I R F_;

Involute interpolation on the Y–Z plane

G19 G02.2 Y_Z J K R F_;

G19 G03.2 Y_Z J K R F_;

Where,

G02.2: Involute interpolation (clockwise)

G03.2: Involute interpolation (counterclockwise)

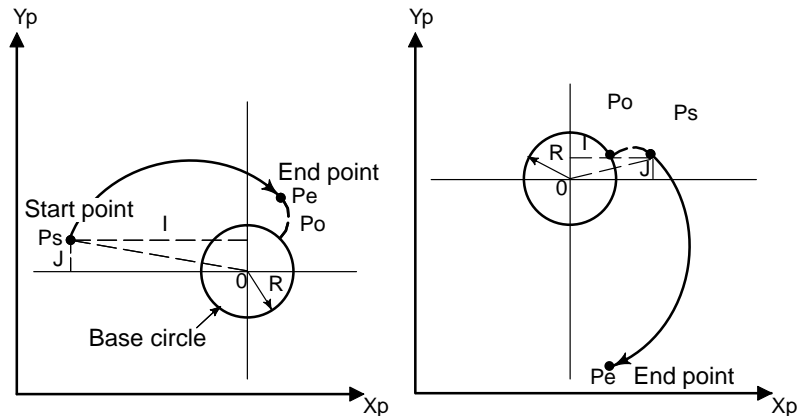
G17/G18/G19 : X–Y / Z–X / Y–Z plane selection

X, Y, Z : Involute curve end coordinate

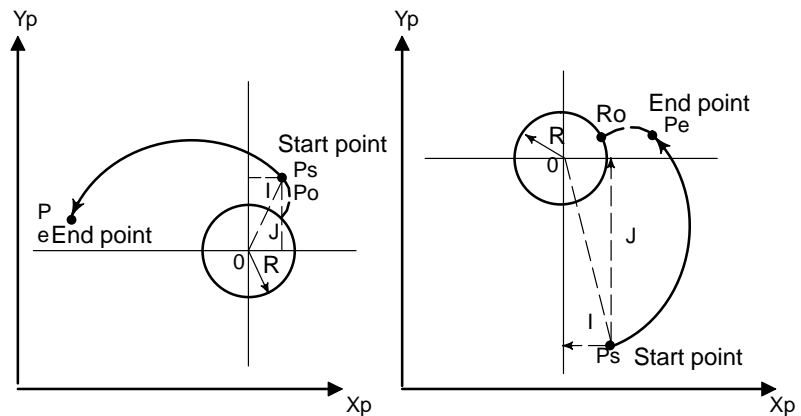
I, J, K : Center of the base circle for an involute curve viewed from the start point

R : Base circle radius

F : Cutting feedrate



Clockwise involute interpolation (G02.2)



Counterclockwise involute interpolation (G03.2)

Explanations

• Involute curve

An involute curve on the X–Y plane is defined as follows ;

$$X(\theta) = R [\cos \theta + (\theta - \theta_0) \sin \theta] + X_0$$

$$Y(\theta) = R [\sin \theta - (\theta - \theta_0) \cos \theta] + Y_0$$

where,

X_0, Y_0 : Coordinates of the center of a base circle

R : Base circle radius

θ_0 : Angle of the start point of an involute curve

θ : Angle of the point where a tangent from the current position to the base circle contacts the base circle

$X(\theta), Y(\theta)$: Current position on the X–axis and Y–axis

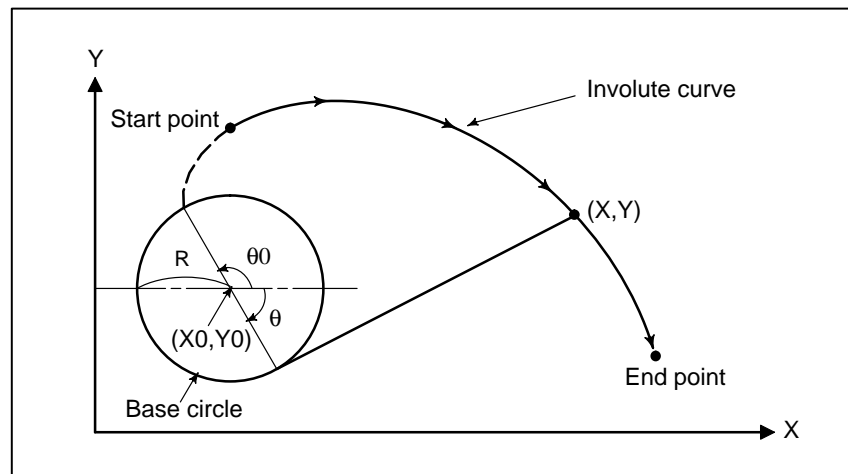


Fig.4.10 (a) Involute Curve

Involute curves on the Z–X plane and Y–Z plane are defined in the same way as an involute curve on the X–Y plane.

• Start point and end point

The end point of an involute curve is specified using address X, Y, or Z. An absolute value or incremental value is used to specify an X, Y, or Z value. When using an incremental value, specify the coordinates of the end point viewed from the start point of the involute curve.

When no end point is specified, P/S alarm No. 241 is issued.

If the specified start point or end point lies within the base circle, P/S alarm No. 242 is issued. The same alarm is issued if cutter compensation C causes the offset vector to enter the base circle. Be particularly careful when applying an offset to the inside of an involute curve.

• Base circle specification

The center of a base circle is specified with I, J, and K, corresponding to X, Y, and Z. The value following I, J, or K is a vector component defined when the center of the base circle is viewed from the start point of the involute curve; this value must always be specified as an incremental value, regardless of the G90/G91 setting. Assign a sign to I, J, and K according to the direction.

If I, J, and K are all left unspecified, or I0J0K0 is specified, P/S alarm No. 241 or No. 242 is issued.

If R is not specified, or $R < 0$, P/S alarm No. 241 or No. 242 is issued.

- **Choosing from two types of involute curves**

When only a start point and I, J, and K data are given, two types of involute curves can be created. One type of involute curve extends towards the base circle, and the other extends away from the base circle. When the specified end point is closer to the center of the base circle than the start point, the involute curve extends toward the base circle. In the opposite case, the involute curve extends away from the base circle.

- **Feedrate**

The cutting feedrate specified in an F code is used as the feedrate for involute interpolation. The feedrate along the involute curve (feedrate along the tangent to the involute curve) is controlled to satisfy the specified feedrate.

- **Plane selection**

As with circular interpolation, the plane to which to apply involute interpolation can be selected using G17, G18, and G19.

- **Cutter compensation C**

Cutter compensation C can be applied to involute curve machining. As with linear and circular interpolation, G40, G41, and G42 are used to specify cutter compensation.

G40 : Cutter compensation cancel

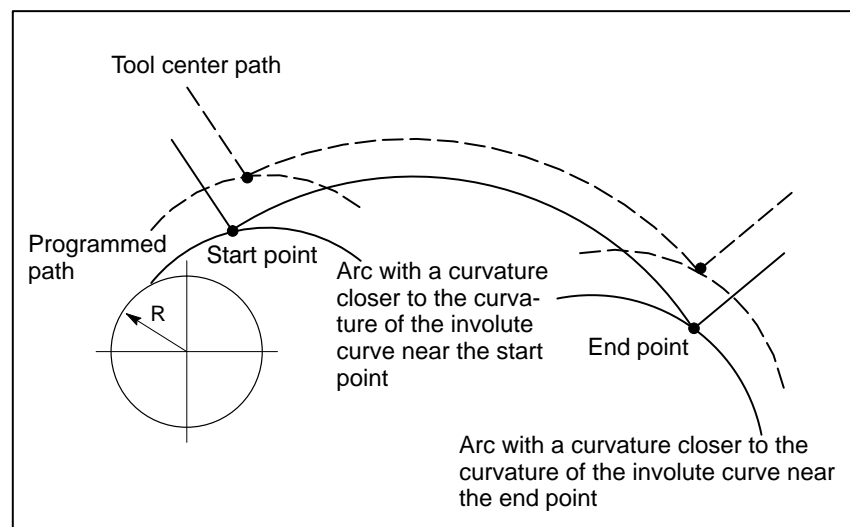
G41 : Cutter compensation left

G42 : Cutter compensation right

Cutter compensation for an involute curve is implemented as described below.

First, near the start point of an involute curve, an arc with a curvature close to the curvature of the involute curve is found. Next, an offset intersection between the arc and the linear line or arc in the previous block is found. Similarly, an offset intersection is found near the end point. Then, the involute curve passing through the two points is used as the tool center path.

In involute interpolation mode, cutter compensation cannot be started or cancelled.



- **Specifiable G codes**

The following G codes can be specified in involute interpolation mode:

G04 : Dwell
 G10 : Data setting
 G17 : X-Y plane selection
 G18 : Z-X plane selection
 G19 : Y-Z plane selection
 G65 : Macro call
 G66 : Macro modal call
 G67 : Macro modal call cancel
 G90 : Absolute command
 G91 : Incremental command

- **Modes that allow involute interpolation specification**

Involute interpolation can be specified in the following G code modes:

G41 : Cutter compensation left
 G42 : Cutter compensation right
 G51 : Scaling
 G51.1 : Programmable mirror image
 G68 : Coordinate rotation

- **End point error**

As shown below the end point may not be located on an involute curve that passes through the start point.

When an involute curve that passes through the start point deviates from the involute curve that passes through the end point by more than the value set in parameter No. 5610, P/S alarm No. 243 is issued.

When there is an end point error, the feedrate is not guaranteed.

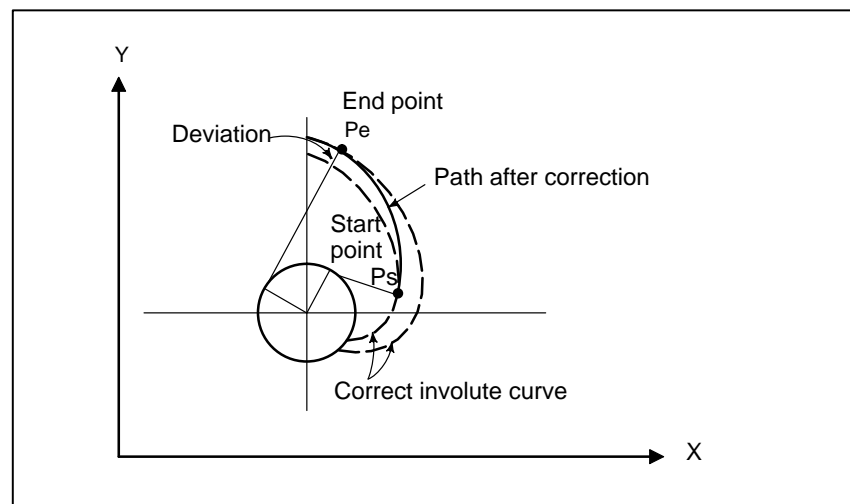


Fig. 4.10 (b) End Point Error in Counterclockwise Involute Interpolation (G03.2)

Limitations

- **Number of involute curve turns**

Both the start point and end point must be within 100 turns from the point where the involute curve starts. An involute curve can be specified to make one or more turns in a single block.
If the specified start point or end point is beyond 100 turns from the point where the involute curve starts, P/S alarm No. 242 is issued.
- **Unspecifiable functions**

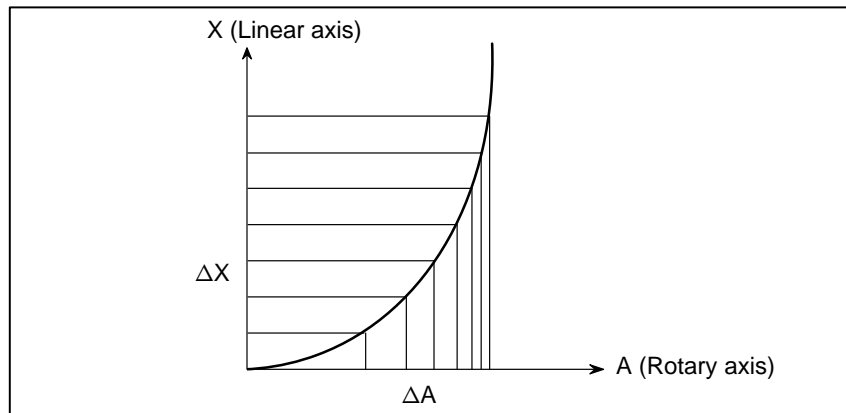
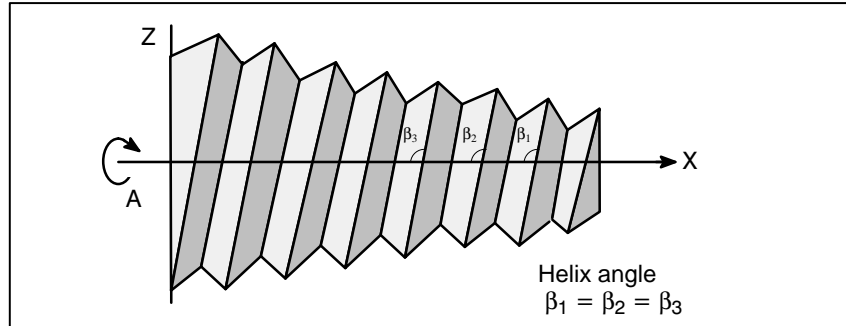
In involute interpolation mode, chamfer corner R (with an arbitrary angle), helical cutting, or axis-by-axis scaling functions cannot be specified.
- **Modes that do not allow involute interpolation specification**

Involute interpolation cannot be used in the following modes:
G41.1 (G151) : Normal direction control left side on
G42.1 (G152) : Normal direction control right side on
G07.1 (G107) : Cylindrical interpolation
G12.1 : Polar coordinate interpolation mode
G16 : Polar coordinates command
G72.1 : Drawing copy
- **Cutting accuracy**

The curvature of an involute curve varies rather sharply near the base circle. In such locations, a larger load is applied to the cutter when the programmed feedrate is used for cutting; in this case, the surface produced may be somewhat uneven

4.11 EXPONENTIAL INTERPOLATION (G02.3, G03.3)

Exponential interpolation exponentially changes the rotation of a workpiece with respect to movement on the rotary axis. Furthermore, exponential interpolation performs linear interpolation with respect to another axis. This enables tapered groove machining with a constant helix angle (constant helix taper machining). This function is best suited for grooving and grinding tools such as end mills.



Format

positive rotation ($\omega=0$)

G02.3 X_ Y_ Z_ I_ J_ K_ R_ F_ Q_ ;

Negative rotation ($\omega=1$)

G03.3 X_ Y_ Z_ I_ J_ K_ R_ F_ Q_ ;

X_ ; Specifies an end point with an absolute or incremental value.

Y_ ; Specifies an end point with an absolute or incremental value.

Z_ ; Specifies an end point with an absolute or incremental value.

I_ ; Specifies angl I (from ± 1 to ± 89 deg in units of 0.001deg).

J_ ; Specifies angle J (from ± 1 to ± 89 deg in units of 0.001deg).

K_ ; Specifies the amount to divide the linear axis for exponential interpolation (span value). Specify a positive value.

When no value is specified, the value specified in parameter (No. 5643) is used.

R_ ; Specifies constant R for exponential interpolation.

F_ ; Specifies the initial feedrate.

Specified in the same way as an ordinary F code. Specify a composite feedrate including a feedrate on the rotary axis.

Q_ ; Specifies the feedrate at the end point.

The same unit used for F is used. The CNC internally performs interpolation between the initial feedrate (F) and final feedrate (Q), depending on the travel distance on the linear axis.

Explanations

• Exponential relational expressions

Exponential relational expressions for a linear axis and rotary axis are defined as follows:

$$X(\theta) = R \times (e^{\frac{\theta}{k}} - 1) \times \frac{1}{\tan(l)} \quad \dots\dots\dots \text{Movement on the linear axis (1)}$$

$$A(\theta) = (-1)^\omega \times 360 \times \frac{\theta}{2\pi} \quad \dots\dots\dots \text{Movement on the rotary axis (2)}$$

Where,

$$K = \frac{\tan(J)}{\tan(l)}$$

$\omega = 0/1$ Rotation direction

R, l, and J are constants, and θ represents an angle (radian)

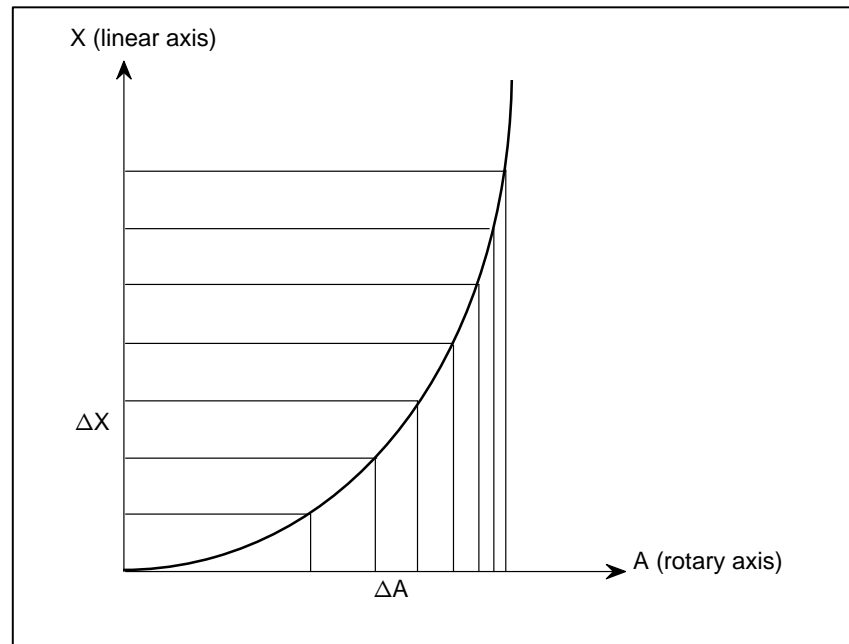
The following is obtained from Expression (1)

$$\theta(X) = K \times \ln\left(\frac{X \times \tan(l)}{R} + 1\right)$$

When there is movement from X_1 to X_2 on the linear axis, the amount of movement on the rotary axis is determined by :

$$\Delta\theta = K \times \left\{ \ln\left(\frac{X_2 \times \tan(l)}{R} + 1\right) - \ln\left(\frac{X_1 \times \tan(l)}{R} + 1\right) \right\}$$

Specify Expressions (1) and (2) in the format described earlier.



Limitations

• Cases where linear interpolation is performed

Even when the G02.3 or G03.3 mode is set, linear interpolation is performed in the following cases:

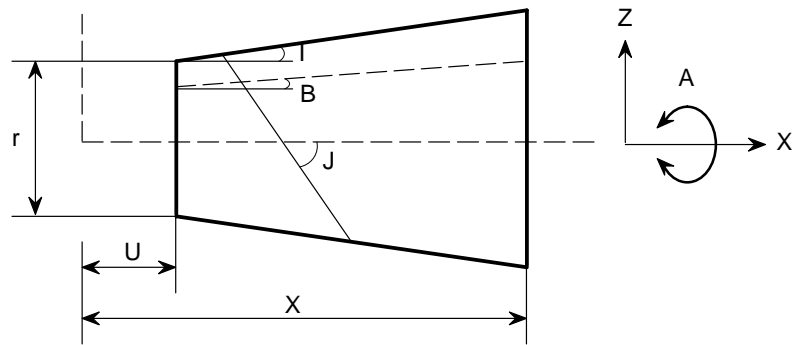
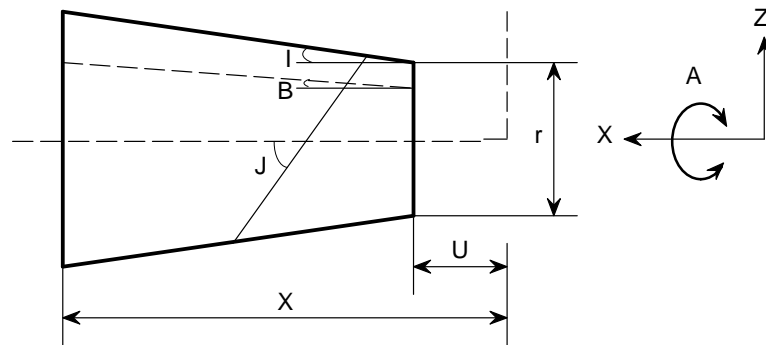
- When the linear axis specified in parameter (No. 5641) is not specified, or the amount of movement on the linear axis is 0
- When the rotary axis specified in parameter (No. 5642) is specified
- When the amount for dividing the linear axis (span value) is 0

• Tool length compensation / cutter compensation

Neither tool length compensation nor cutter compensation can be used in the G02.3 and G03.3 modes.

CAUTION

The amount for dividing the linear axis for exponential interpolation (span value) affects figure precision. However, if an excessively small value is set, the machine may stop during interpolation. Try to specify an optimal span value depending on the machine being used.

Examples**Constant helix machining for producing a tapered figure****Constant helix machining for producing a reverse tapered figure**

Relational expressions

$$Z(\theta) = \left\{ \frac{r}{2} - U \times \tan(I) \right\} \times (e^{\frac{\theta}{K}} - 1) \times \frac{\tan(B)}{\tan(I)} + Z(0) \quad \dots\dots\dots (3)$$

$$X(\theta) = \left\{ \frac{r}{2} - U \times \tan(I) \right\} \times (e^{\frac{\theta}{K}} - 1) \times \frac{1}{\tan(I)} \quad \dots\dots\dots (4)$$

$$A(\theta) = (-1)^\omega \times 360 \times \frac{\theta}{2\pi}$$

where

$$K = \frac{\tan(J)}{\tan(I)}$$

X(θ), Z(θ), A(θ): Absolute value on the X-axis, Z-axis, and A-axis from the origin

r : Left end diameter

U : Excess length

I : Taper angle

B : Groove bottom taper angle

J : Helix angle

X : Amount of movement on the linear axis

ω : Helix direction (0: Positive, 1: Negative)

θ : Workpiece rotation angle

From expressions (3) and (4), the following is obtained ;

$$Z(\theta) = \tan(B) \times X(\theta) + Z(0) \quad \dots\dots\dots (5)$$

The groove bottom taper angle (B) is determined from the end point position on the X-axis and Z-axis according to Expression 5. The amount of movement on the Z-axis is determined from a groove bottom taper angle (B) and X-axis position.

From Expressions (1) and (4), the following is determined:

$$R = r/2 - U \times \tan(I) \quad \dots\dots\dots (6)$$

Constant R is determined from the left end diameter (r) and excess length (U) according to Expression (6). Specify a taper angle (I) in address I, and specify a helix angle (J) in address J. Note, however, that a negative value must be specified as the taper angle (I) for constant helix machining in order to produce a reverse tapered figure. Select a helix direction with G02.3 or G03.3. The user can perform constant helix machining to produce a tapered figure or a reverse tapered figure.

4.12 SMOOTH INTERPOLATION (G05.1)

Either of two types of machining can be selected, depending on the program command.

- For those portions where the accuracy of the figure is critical, such as at corners, machining is performed exactly as specified by the program command.
- For those portions having a large radius of curvature where a smooth figure must be created, points along the machining path are interpolated with a smooth curve, calculated from the polygonal lines specified with the program command (smooth interpolation).

Smooth interpolation can be specified when CDSP (bit 5 of parameter No. 8485) is set to 1 in high-speed contour control mode (between G05 P10000 and G05 P0). Smooth interpolation performed in high-speed contour control mode is described below. For details of high-speed contour control, see Section 20.5.

Format

Starting of smooth interpolation mode

```
G05.1 Q2X0Y0Z0;
```

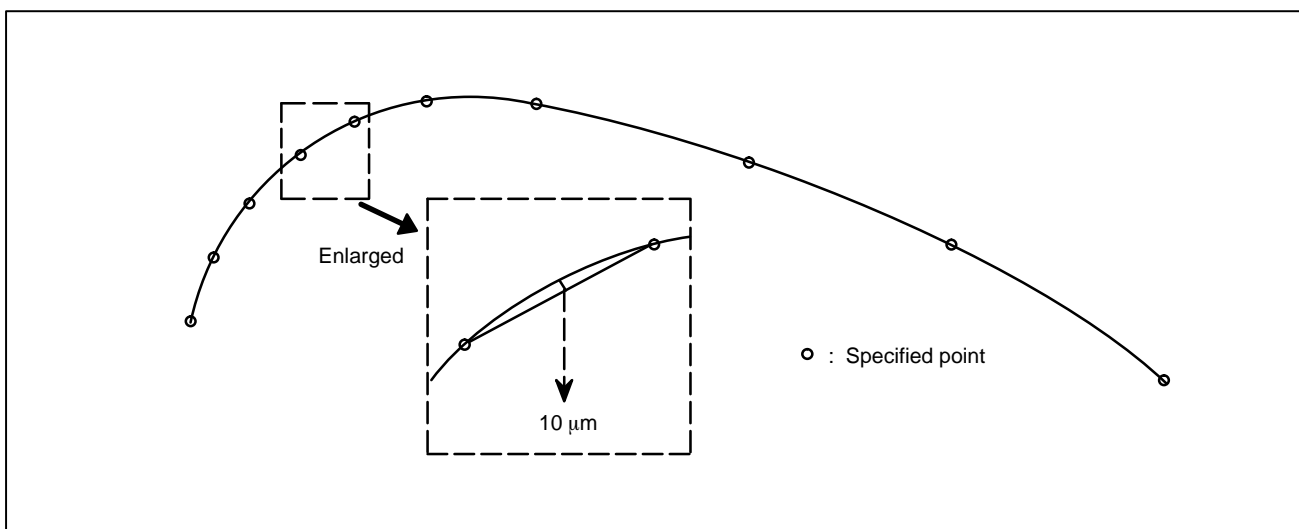
Cancelation of smooth interpolation mode

```
G05.1 Q 0;
```

Explanations

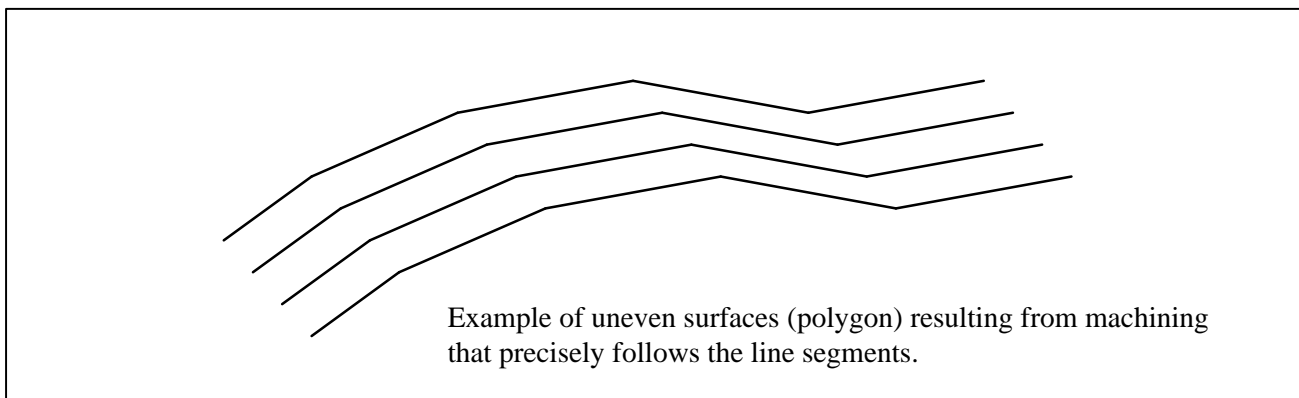
- **Characteristics of smooth interpolation**

To machine a part having sculptured surfaces, such as metal moldings used in automobiles and airplanes, a part program usually approximates the sculptured surfaces with minute line segments. As shown in the following figure, a sculptured curve is normally approximated using line segments with a tolerance of about 10 μm .



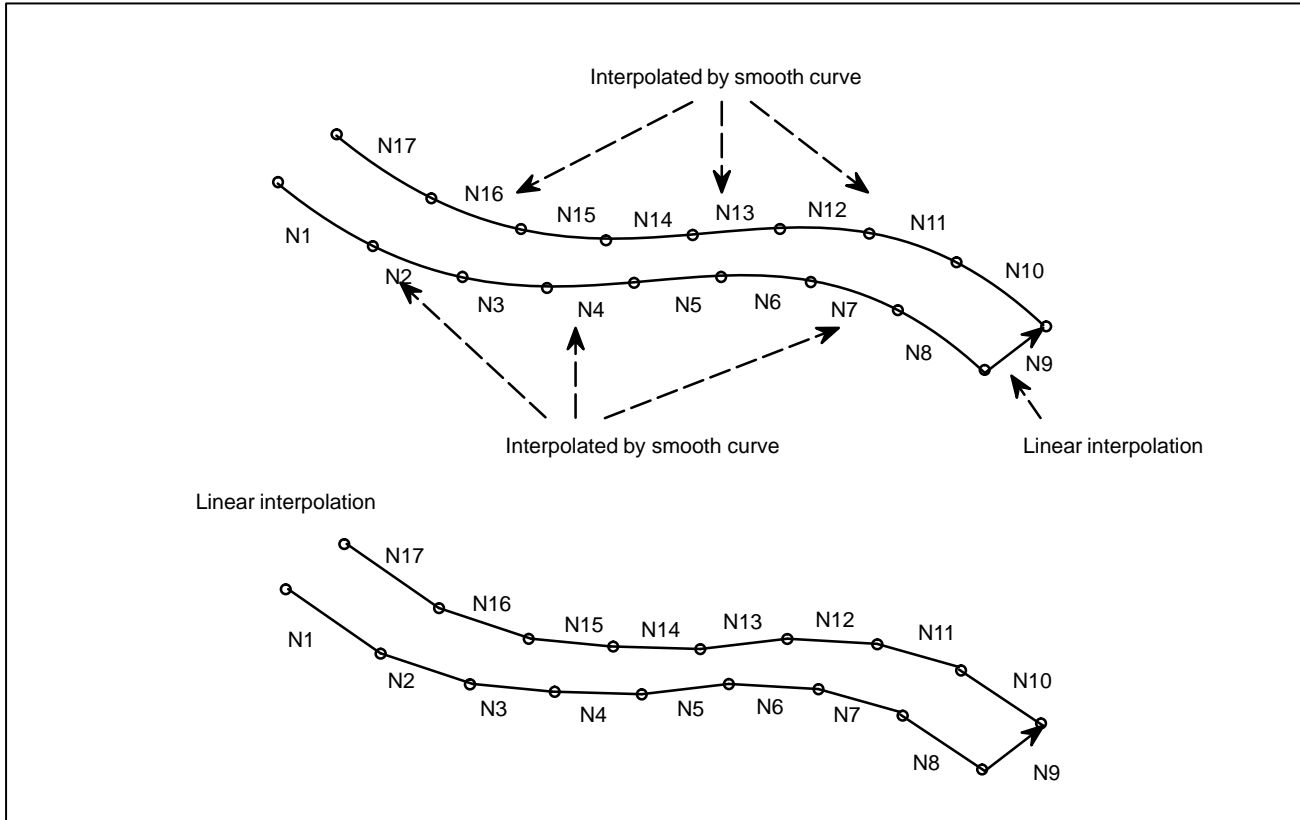
When a program approximates a sculptured curve with line segments, the length of each segment differs between those portions that have mainly a small radius of curvature and those that have mainly a large radius of curvature. The length of the line segments is short in those portions having a small radius of curvature, while it is long in those portions having a large radius of curvature. The high-precision contour control moves the tool along a programmed path thus enabling highly precise machining. This means that the tool movement precisely follows the line segments used to approximate a sculptured curve. This may result in a non-smooth machined curve if control is applied to machining a curve where the radius of curvature is large and changes only gradually. Although this effect is caused by high-precision machining, which precisely follows a pre-programmed path, the uneven corners that result will be judged unsatisfactory when smooth surfaces are required.

Profile	Portions having mainly a small radius of curvature	Portions having mainly a large radius of curvature
Example of machined parts	Automobile parts	Decorative parts, such as body side moldings
Length of line segment	Short	Long
Resulting surfaces produced using high-precision contour control	Smooth surface even when machining is performed exactly as specified by a program	Uneven surfaces may result when machining is performed exactly as specified by a program



In smooth interpolation mode, the CNC automatically determines, according to the program command, whether an accurate figure is required, such as at corners, or a smooth figure is required where the radius of curvature is large. If a block specifies a travel distance or direction which differs greatly from that in the preceding block, smooth interpolation is not performed for that block. Linear interpolation is performed exactly as specified by the program command. Programming is thus very simple.

Examples



• Conditions for performing smooth interpolation

Smooth interpolation is performed when all the following conditions are satisfied. If any of the following conditions is not satisfied for a block, that block is executed without smooth interpolation then the conditions are checked for the next block.

- (1) The machining length specified in the block is shorter than the length specified with parameter No. 8486.
- (2) The machining length is other than 0.
- (3) The modes are:
 - G01 : Linear interpolation
 - G13.1 : Polar coordinate interpolation cancel
 - G15 : Polar coordinate command cancel
 - G40 : Cutter compensation cancel
(except for 3-dimensional tool compensation)
 - G64 : Cutting mode
 - G80 : Canned cycle cancel
 - G94 : Feed per minute
- (4) Machining is specified only along the axes specified with G05.1Q2.
- (5) The block is judged to be unsuitable for smooth interpolation, as performed with the internal algorithm of the CNC.

• Commands which cancel smooth interpolation

- (1) Auxiliary and second auxiliary functions
- (2) M98, M99 : Subprogram call
M198 : Calling a subprogram in external memory

Limitations

- Controlled axes** Smooth interpolation can be specified only for the X-, Y-, and Z-axes and any axes parallel to these axes (up to three axes at one time).
- High-precision contour control mode** Commands for turning on and off smooth interpolation mode must be executed in high-precision contour control mode.

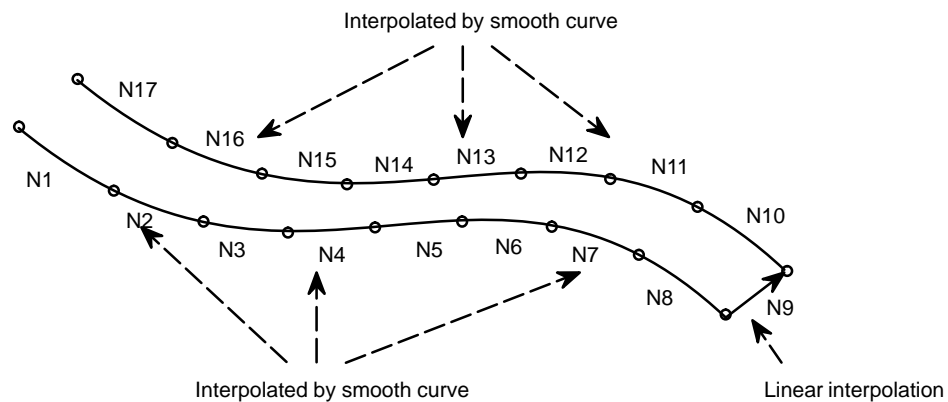
Examples

Example program for smooth interpolation

```

G05 P10000 ;
.
.
G91 ;
G05.1 Q2 X0 Y0 Z0 ;
N01 G01 X1000 Z-300 ;
N02 X1000 Z-200 ;
N03 X1000 Z-50 ;
N04 X1000 Z50 ;
N05 X1000 Z50 ;
N06 X1000 Z-25 ;
N07 X1000 Z-175 ;
N08 X1000 Z-350 ;
N09 Y1000 ;
N10 X-1000 Z350 ;
N11 X-1000 Z175 ;
N12 X-1000 Z25 ;
N13 X-1000 Z- 50 ;
N14 X-1000 Z- 50 ;
N15 X-1000 Z50 ;
N16 X-1000 Z200 ;
N17 X-1000 Z300 ;
G05.1 Q0 ;
.
.
G05 P0 ;
.
.

```



4.13 NURBS INTERPOLATION (G06.2)

Many computer-aided design (CAD) systems used to design metal dies for automobiles and airplanes utilize non-uniform rational B-spline (NURBS) to express a sculptured surface or curve for the metal dies.

This function enables NURBS curve expression to be directly specified to the CNC. This eliminates the need for approximating the NURBS curve with minute line segments. This offers the following advantages:

- 1.No error due to approximation of a NURBS curve by small line segments
- 2.Short part program
- 3.No break between blocks when small blocks are executed at high speed
- 4.No need for high-speed transfer from the host computer to the CNC

When this function is used, a computer-aided machining (CAM) system creates a NURBS curve according to the NURBS expression output from the CAD system, after compensating for the length of the tool holder, tool diameter, and other tool elements. The NURBS curve is programmed in the NC format by using these three defining parameters: control point, weight, and knot.

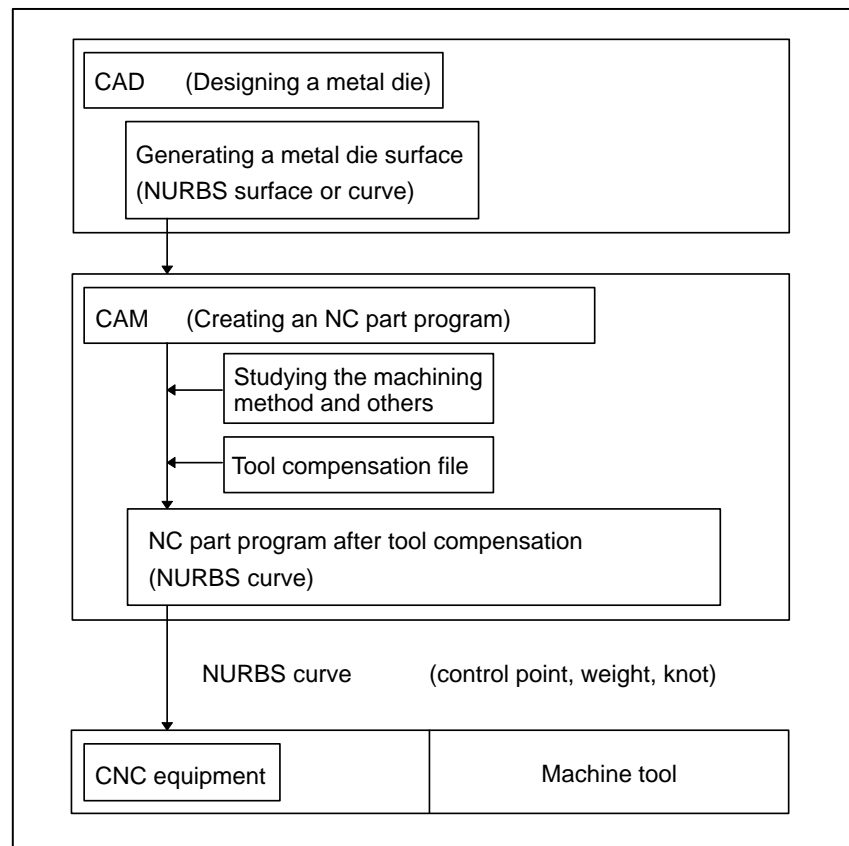


Fig. 4.13 NC part program for machining a metal die according to a NURBS curve

NURBS interpolation must be specified in high-precision contour control mode (between G05 P10000 and G05 P0). The CNC executes NURBS interpolation while smoothly accelerating or decelerating the movement so that the acceleration on each axis will not exceed the allowable maximum acceleration of the machine. In this way, the CNC automatically controls the speed in order to prevent excessive strain being imposed on the machine. For details of high-precision contour control, see Section II-19.5.

Format

```

G05 P10000 ; (Start high-precision contour control mode)
...
G06.2 [P_] K_ X_ Y_ Z_ [R_] [F_] ;
           K_ X_ Y_ Z_ [R_] ;
           K_ X_ Y_ Z_ [R_] ;
           K_ X_ Y_ Z_ [R_] ;
           ...
           K_ X_ Y_ Z_ [R_] ;
           K_ ;
           ...
           K_ ;

G01 ...
...
G05 P0 ; (End high-precision contour control mode)

G06.2 : Start NURBS interpolation mode
P_ : Rank of NURBS curve
X_ Y_ Z_ : Control point
R_ : Weight
K_ : Knot
F_ : Feedrate

```

Explanations

- **NURBS interpolation mode**

NURBS interpolation mode is selected when G06.2 is programmed in high-precision contour control mode. G06.2 is a modal G code of group 01. NURBS interpolation mode ends when a G code of group 01 other than G06.2 (G00, G01, G02, G03, etc.) is specified. NURBS interpolation mode must end before the command for ending high-precision contour control mode is programmed.

- **Rank of NURBS**

A rank of NURBS can be specified with address P. The rank setting, if any, must be specified in the first block. If the rank setting is omitted, a rank of four (degree of three) is assumed for NURBS. The valid data range for P is 2 to 4. The P values have the following meanings:

P2: NURBS having a rank of two (degree of one)

P3: NURBS having a rank of three (degree of two)

P4: NURBS having a rank of four (degree of three) (default)

This rank is represented by k in the defining expression indicated in the description of NURBS curve below. For example, a NURBS curve having a rank of four has a degree of three. The NURBS curve can be expressed by the constants t^3 , t^2 , and t^1 .

- **Weight**

The weight of a control point programmed in a single block can be defined. When the weight setting is omitted, a weight of 1.0 is assumed.

- **Knot**

The number of specified knots must equal the number of control points plus the rank value. In the blocks specifying the first to last control points, each control point and a knot are specified in an identical block. After these blocks, as many blocks (including only a knot) as the rank value are specified. The NURBS curve programmed for NURBS interpolation must start from the first control point and end at the last control point. The first k knots (where k is the rank) must have the same values as the last k knots (multiple knots). If the absolute coordinates of the start point of NURBS interpolation do not match the position of the first control point, P/S alarm No. 5117 is issued. (To specify incremental values, G06.2 X0 Y0 Z0 K_ must be programmed.)

- **NURBS curve**

Using these variables:

k : Rank

P_i : Control point

W_i : Weight

X_i : Knot ($X_i \leq X_{i+1}$)

Knot vector [X_0, X_1, \dots, X_m] ($m = n + k$)

t : Spline parameter,

the spline basis function N can be expressed with the de Boor-Cox recursive formula, as indicated below:

$$N_{i,1}(t) = \begin{cases} 1 & (x_i \leq t \leq x_{i+1}) \\ 0 & (t < x_i, x_{i+1} < t) \end{cases}$$

$$N_{i,k}(t) = \frac{(t-x_i) N_{i,k-1}(t)}{x_{i+k-1} - x_i} + \frac{(x_{i+k}-t) N_{i+1,k-1}(t)}{x_{i+k} - x_{i+1}}$$

The NURBS curve P(t) of interpolation can be expressed as follows:

$$\mathbf{P}(t) = \frac{\sum_{i=0}^n N_{i,k}(t) w_i \mathbf{P}_i}{\sum_{i=0}^n N_{i,k}(t) w_i} \quad (x_0 \leq t \leq x_m)$$

- **Reset**

A reset during NURBS interpolation results in the clear state. The modal code of group 1 enters the state specified in the G01 bit (bit 0 of parameter 3402).

Limitations

- **Controlled axes**

NURBS interpolation can be performed on up to three axes. The axes of NURBS interpolation must be specified in the first block. A new axis cannot be specified before the beginning of the next NURBS curve or before NURBS interpolation mode ends.

- **Command in NURBS interpolation mode**

In NURBS interpolation mode, any command other than the NURBS interpolation command (miscellaneous function and others) cannot be specified.

- **Manual intervention**

If manual intervention is attempted while manual absolute mode is set, P/S alarm No. 5118 is issued.

- **Cutter compensation**

Cutter compensation cannot be simultaneously executed. NURBS interpolation can only be specified after cutter compensation has been canceled.

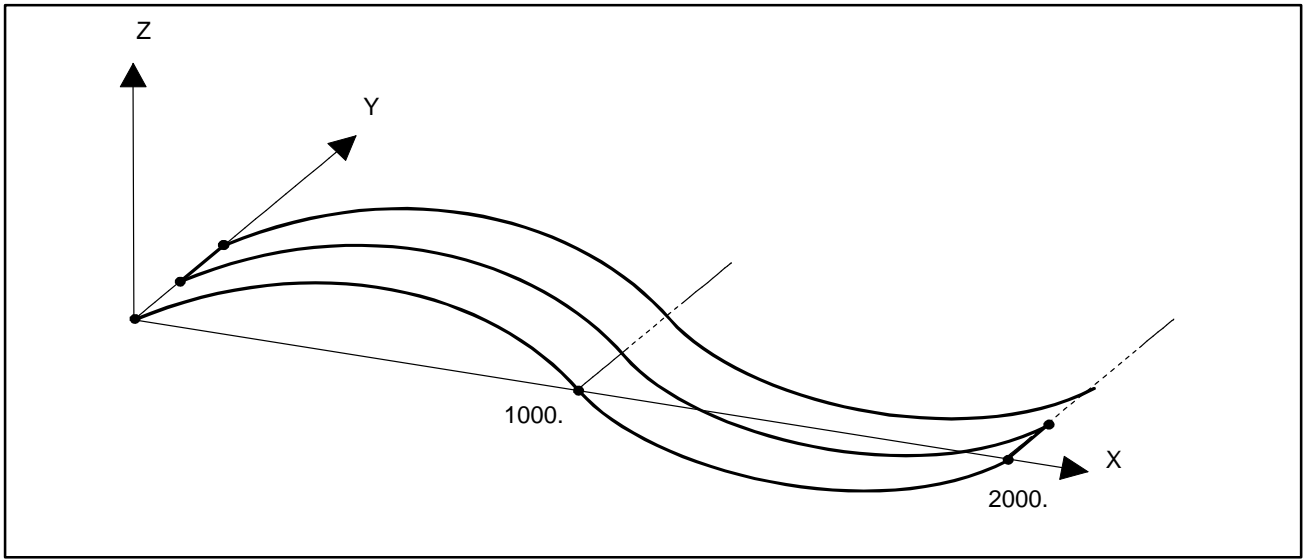
Alarms

No.	Displayed message	Description
PS5115	SPL: Error	An illegal rank is specified.
		No knot is specified.
		An illegal knot is specified.
		Too many axes are specified.
		Other program error.
PS5116	SPL: Error	A look-ahead block contains a program error.
		The knot does not increase at a constant rate.
		An inhibited mode is specified in NURBS interpolation mode.
PS5117	SPL: Error	The first NURBS control point is illegal.
PS5118	SPL: Error	An attempt was made to resume NURBS interpolation after manual intervention in manual absolute mode.

Example

<Sample NURBS interpolation program>

```
G05 P10000;
G90;
...
G06.2 K0. X0. Z0.;
      K0. X300. Z100.;
      K0. X700. Z100.;
      K0. X1300. Z-100.;
      K0.5 X1700. Z-100.;
      K0.5 X2000. Z0.;
      K1.0;
      K1.0;
      K1.0;
      K1.0;
G01 Y0.5;
G06.2 K0. X2000. Z0.;
      K0. X1700. Z-100.;
      K0. X1300. Z-100.;
      K0. X700. Z100.;
      K0.5 X300. Z100.;
      K0.5 X0. Z0.;
      K1.0;
      K1.0;
      K1.0;
      K1.0;
G01 Y0.5;
G06.2 ...
...
G01 ...
G05P0;
```



4.14 HYPOTHETICAL AXIS INTERPOLATION (G07)

In helical interpolation, when pulses are distributed with one of the circular interpolation axes set to a hypothetical axis, sine interpolation is enabled.

When one of the circular interpolation axes is set to a hypothetical axis, pulse distribution causes the speed of movement along the remaining axis to change sinusoidally. If the major axis for threading (the axis along which the machine travels the longest distance) is set to a hypothetical axis, threading with a fractional lead is enabled. The axis to be set as the hypothetical axis is specified with G07.

Format

G07 α 0; Hypothetical axis setting

G07 α 1; Hypothetical axis cancel

Where, α is any one of the addresses of the controlled axes.

Explanations

- **Sine interpolation**

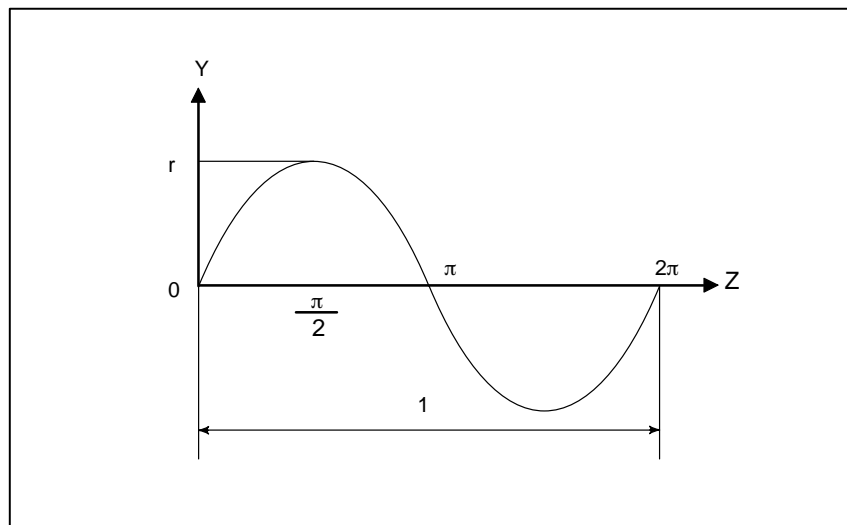
The α axis is regarded as a hypothetical axis for the period of time from the G07 α 0 command until the G07 α 1 command appears.

Suppose sine interpolation is performed for one cycle in the YZ plane. The hypothetical axis is then the X axis.

$$X^2 + Y^2 = r^2 \text{ (r is the radius of an arc.)}$$

$$Y = r \text{ SIN} \left(\frac{2\pi}{1} Z \right)$$

(1 is the distance traveled along the Z-axis in one cycle.)



- **Interlock, stroke limit, and external deceleration**

Interlock, stroke limit, and external deceleration can also apply to the hypothetical axis.

- **Handle interrupt**

An interrupt caused by the handle also applies to the hypothetical axis. This means that movement for a handle interrupt is performed.

Limitations

- **Manual operation**
- **Move command**
- **Coordinate rotation**

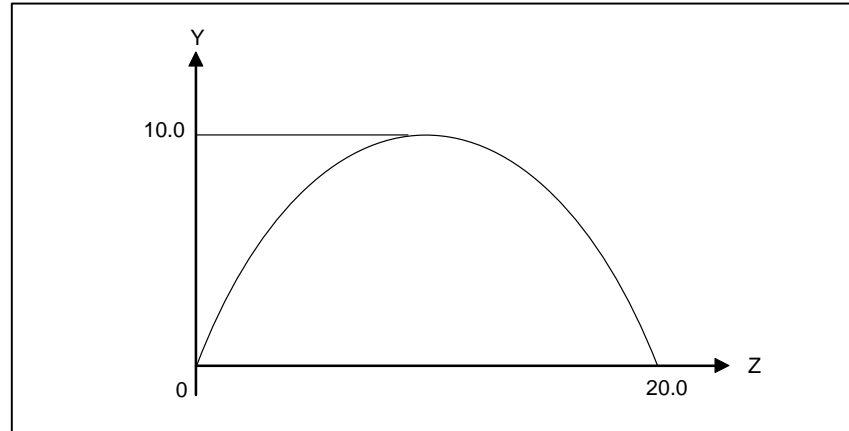
The hypothetical axis can be used only in automatic operation. In manual operation, it is not used, and movement takes place.

Specify hypothetical axis interpolation only in the incremental mode.

Hypothetical axis interpolation does not support coordinate rotation.

Examples

- **Sine interpolation**



```
N001 G07 X0 ;
N002 G91 G17 G03 X-20.2 Y0.0 I-10.0 Z20.0 F100 ;
N003 G01 X10.0 ;
N004 G07 X1 ;
```

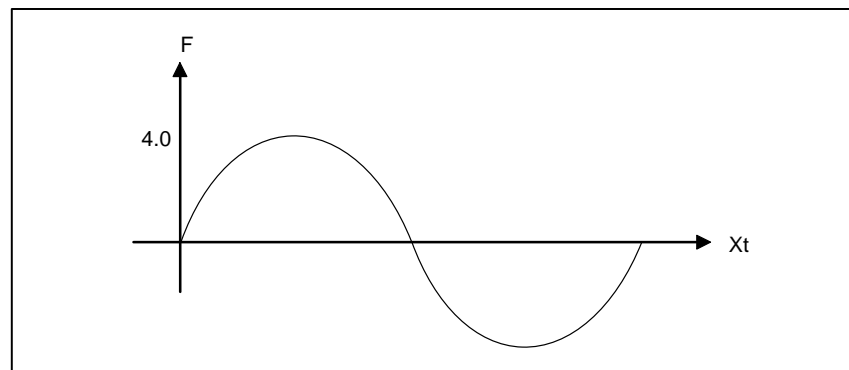
From the N002 to N003 blocks, the X-axis is set to a hypothetical axis. The N002 block specifies helical cutting in which the Z-axis is the linear axis. Since no movement takes place along the X axis, movement along the Y-axis is performed while performing sine interpolation along the Z-axis.

In the N003 block, there is no movement along the X-axis, and so the machine dwells until interpolation terminates.

- **Changing the feedrate to form a sine curve**

(Sample program)

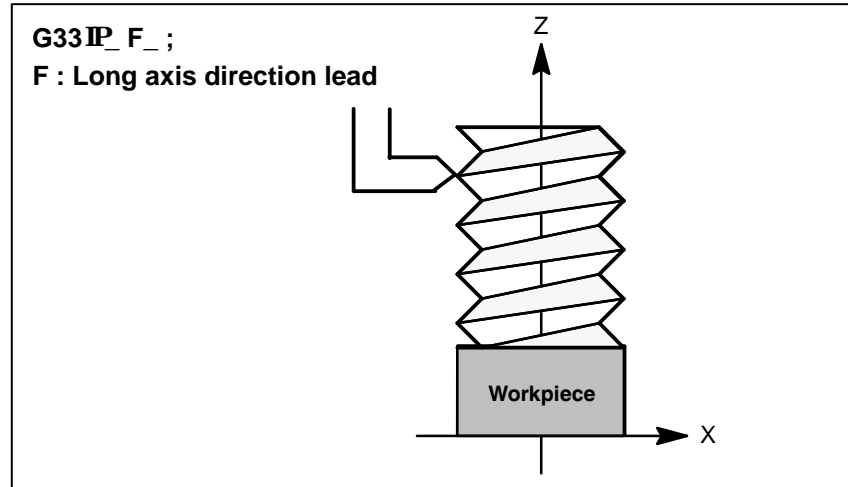
```
G07Z0 ;           The Z-axis is set to a hypothetical axis.
G02X0Z0I10.0F4. ; The feedrate on the X-axis changes sinusoidally.
G07Z1 ;           The use of the Z-axis as a hypothetical axis is canceled.
```



4.15 THREAD CUTTING (G33)

Format

Straight threads with a constant lead can be cut. The position coder mounted on the spindle reads the spindle speed in real-time. The read spindle speed is converted to the feedrate per minute to feed the tool.



Explanations

In general, thread cutting is repeated along the same tool path in rough cutting through finish cutting for a screw. Since thread cutting starts when the position coder mounted on the spindle outputs a 1-turn signal, threading is started at a fixed point and the tool path on the workpiece is unchanged for repeated thread cutting. Note that the spindle speed must remain constant from rough cutting through finish cutting. If not, incorrect thread lead will occur.

In general, the lag of the servo system, etc. will produce somewhat incorrect leads at the starting and ending points of a thread cut. To compensate for this, a thread cutting length somewhat longer than required should be specified.

Table 4.15 (a) lists the ranges for specifying the thread lead.

Table. 4.15 (a) Ranges of lead sizes that can be specified

	Least command increment	Command value range of the lead
mm input	0.001 mm	F1 to F50000 (0.01 to 500.00mm)
	0.0001 mm	F1 to F50000 (0.01 to 500.00mm)
Inch input	0.0001 inch	F1 to F99999 (0.0001 to 9.9999inch)
	0.00001 inch	F1 to F99999 (0.0001 to 9.9999inch)

NOTE

1 The spindle speed is limited as follows :

$$1 \leq \text{spindle speed} \leq \frac{\text{Maximum feedrate}}{\text{Thread lead}}$$

Spindle speed : rpm

Thread lead : mm or inch

Maximum feedrate : mm/min or inch/min ; maximum command-specified feedrate for feed-per-minute mode or maximum feedrate that is determined based on mechanical restrictions including those related to motors, whichever is smaller

2 Cutting feedrate override is not applied to the converted feedrate in all machining process from rough cutting to finish cutting. The feedrate is fixed at 100%

3 The converted feedrate is limited by the upper feedrate specified.

4 Feed hold is disabled during threading. Pressing the feed hold key during thread cutting causes the machine to stop at the end point of the next block after threading (that is, after the G33 mode is terminated)

Examples

Thread cutting at a pitch of 1.5mm
G33 Z10. F1.5;

4.16 SKIP FUNCTION(G31)

Linear interpolation can be commanded by specifying axial move following the G31 command, like G01. If an external skip signal is input during the execution of this command, execution of the command is interrupted and the next block is executed.

The skip function is used when the end of machining is not programmed but specified with a signal from the machine, for example, in grinding. It is used also for measuring the dimensions of a workpiece.

Format

G31 IP_ ;

G31: One-shot G code (If is effective only in the block in which it is specified)

Explanations

The coordinate values when the skip signal is turned on can be used in a custom macro because they are stored in the custom macro system variable #5061 to #5068, as follows:

#5061 X axis coordinate value
 #5062 Y axis coordinate value
 #5063 Z axis coordinate value
 #5064 4th axis coordinate value
 #5065 5th axis coordinate value
 #5066 6th axis coordinate value
 #5067 7th axis coordinate value
 #5068 8th axis coordinate value

WARNING

Disable feedrate override, dry run, and automatic acceleration/deceleration (however, these become available by setting the parameter SKF No.6200#7 to 1.) when the feedrate per minute is specified, allowing for an error in the position of the tool when a skip signal is input. These functions are enabled when the feedrate per rotation is specified.

NOTE

If G31 command is issued while cutter compensation C is applied, an P/S alarm of No.035 is displayed. Cancel the cutter compensation with the G40 command before the G31 command is specified.

Examples

- The next block to G31 is an incremental command

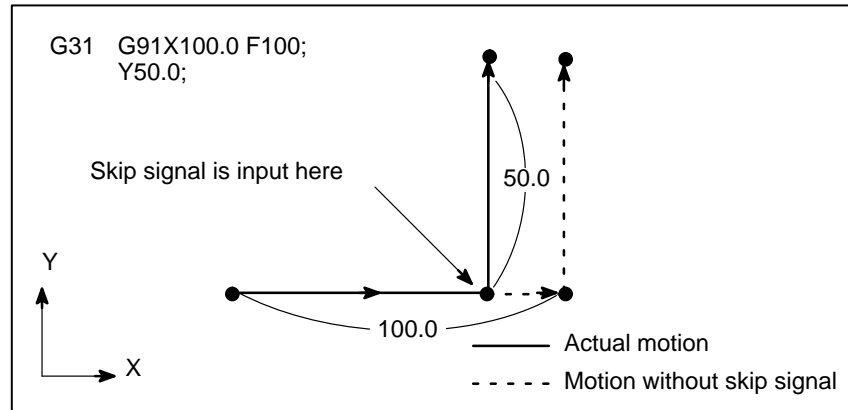


Fig.4.16 (a) The next block is an incremental command

- The next block to G31 is an absolute command for 1 axis

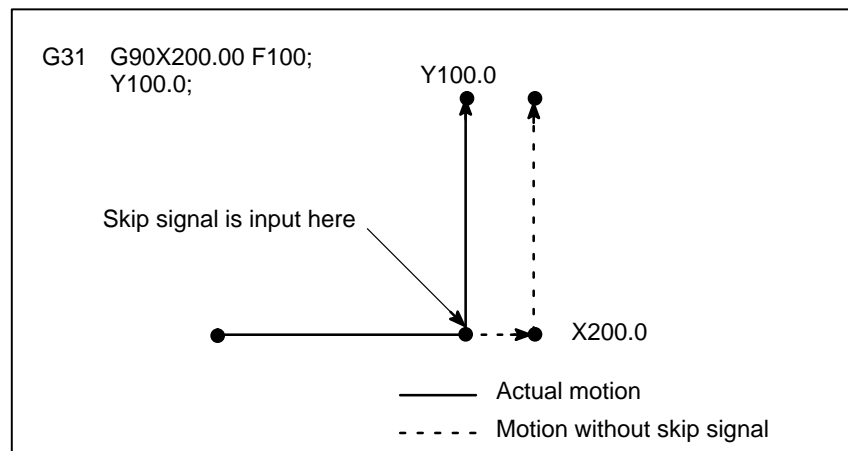


Fig.4.16 (b) The next block is an absolute command for 1 axis

- The next block to G31 is an absolute command for 2 axes

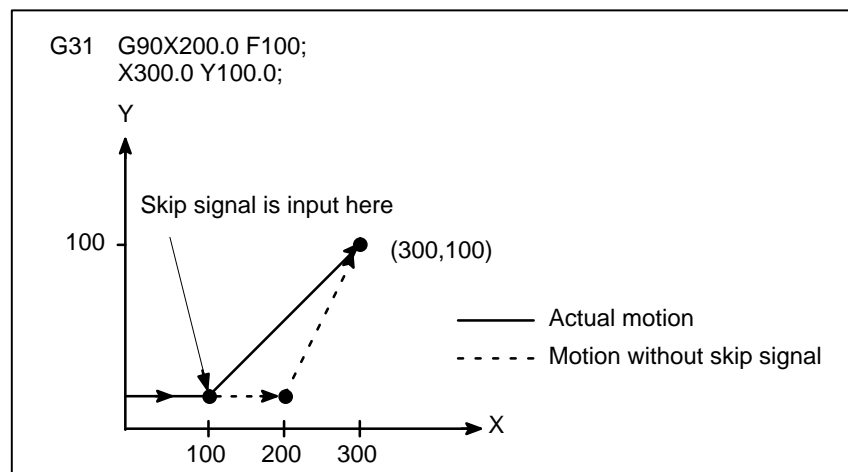


Fig 4.16 (c) The next block is an absolute command for 2 axes

4.17 MULTISTAGE SKIP (G31)

In a block specifying P1 to P4 after G31, the multistage skip function stores coordinates in a custom macro variable when a skip signal (4-point or 8-point ; 8-point when a high-speed skip signal is used) is turned on. Parameters No. 6202 to No. 6205 can be used to select a 4-point or 8-point (when a high-speed skip signal is used) skip signal. One skip signal can be set to match multiple Pn or Qn (n=1,2,3,4) as well as to match a Pn or Qn on a one-to-one basis. Parameters DS1 to DS8 (No. 6206 #0A#7) can be used for dwell.

A skip signal from equipment such as a fixed-dimension size measuring instrument can be used to skip programs being executed.

In plunge grinding, for example, a series of operations from rough machining to spark-out can be performed automatically by applying a skip signal each time rough machining, semi-fine machining, fine-machining, or spark-out operation is completed.

Format

Move command

G31 IP_ F_ P_ ;

IP_ : End point

F_ : Feedrate

P_ : P1-P4

Dwell

G04 X (U, P)_ (Q_)

;

X(U, P)_ : Dwell time

Q_ : Q1 - Q4

Explanations

Multistage skip is caused by specifying P1, P2, P3, or P4 in a G31 block. For an explanation of selecting (P1, P2, P3, or P4), refer to the manual supplied by the machine tool builder.

Specifying Q1, Q2, Q3, or Q4 in G04 (dwell command) enables dwell skip in a similar way to specifying G31. A skip may occur even if Q is not specified. For an explanation of selecting (Q1, Q2, Q3, or Q4), refer to the manual supplied by the machine tool builder.

- **Correspondence to skip signals**

Parameter Nos. 6202 to 6205 can be used to specify whether the 4-point or 8-point skip signal is used (when a high-speed skip signal is used). Specification is not limited to one-to-one correspondence. It is possible to specify that one skip signal correspond to two or more Pn's or Qn's (n=1, 2, 3, 4). Also, bits 0 (DS1) to 7 (DS8) of parameter No. 6206 can be used to specify dwell.

CAUTION

Dwell is not skipped when Qn is not specified and parameters DS1-DS8 (No. 6206#0-#7) are not set.

4.18 HIGH SPEED SKIP SIGNAL (G31)

The skip function operates based on a high-speed skip signal (connected directly to the NC; not via the PMC) instead of an ordinary skip signal. In this case, up to eight signals can be input.

Delay and error of skip signal input is 0 – 2 msec at the NC side (not considering those at the PMC side).

This high-speed skip signal input function keeps this value to 0.1 msec or less, thus allowing high precision measurement.

For details, refer to the appropriate manual supplied from the machine tool builder.

Format

G31 IP_ ;

G31: One-shot G code (If is effective only in the block in which it is specified)

4.19 CONTINUOUS HIGH-SPEED SKIP FUNCTION (G31)

The continuous high-speed skip function enables reading of absolute coordinates by using the high-speed skip signal. Once a high-speed skip signal has been input in a G31P90 block, absolute coordinates are read into custom macro variables #5061 to #5068. The input of a skip signal does not stop axial movement, thus enabling reading of the coordinates of two or more points.

The rising and falling edges of the high-speed skip signal can be used as a trigger, depending on the parameter BHIS (No. 6201#5) setting.

Format

G31 P90 α __ F__

α __: Skip axis address and amount of travel
Only one axis can be specified. G31 is a one-shot G code.

Explanations

- **Custom macro variables**

Once a high-speed skip signal has been input in a G31P90 block, absolute coordinates are read into custom macro variables #5061 to #5068. These variables are immediately updated once the tool reaches the next skip position. The feedrate must, therefore, be specified such that the tool does not reach the next skip position before the application completes reading of the variables. For details of the application, refer to the appropriate manual supplied from the machine tool builder.

#5061 Coordinate along the first axis
#5062 Coordinate along the second axis
#5063 Coordinate along the third axis
:
#5068 Coordinate along the eighth axis

- **High-speed skip signal**

This function is enabled only when a high-speed skip signal is used.

The high-speed skip signal to be used is selected with bits 0 to 7 of parameter No. 6208 (9S1 to 9S8).

- **End of block**


The G31P90 block is terminated when the tool reaches the end point.

Limitations

- **Controlled axes**

Only one axis can be specified in the block for the continuous high-speed skip function (G31P90). If two or more axes are specified, P/S alarm No. 5068 is issued.

5 FEED FUNCTIONS



5.1 GENERAL

- **Feed functions**

The feed functions control the feedrate of the tool. The following two feed functions are available:

1. Rapid traverse
When the positioning command (G00) is specified, the tool moves at a rapid traverse feedrate set in the CNC (parameter No. 1420).
2. Cutting feed
The tool moves at a programmed cutting feedrate.

- **Override**

Override can be applied to a rapid traverse rate or cutting feedrate using the switch on the machine operator's panel.

- **Automatic acceleration/ deceleration**

To prevent a mechanical shock, acceleration/deceleration is automatically applied when the tool starts and ends its movement (Fig. 5.1 (a)).

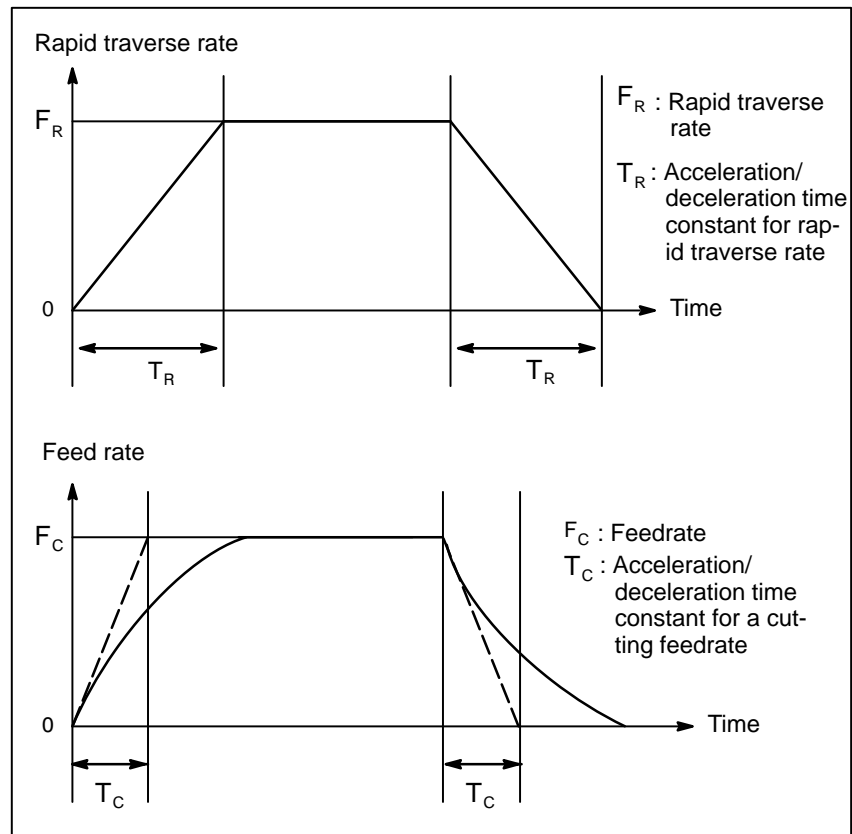


Fig. 5.1 (a) Automatic acceleration/deceleration (example)

- **Tool path in a cutting feed**

If the direction of movement changes between specified blocks during cutting feed, a rounded-corner path may result (Fig. 5.1 (b)).

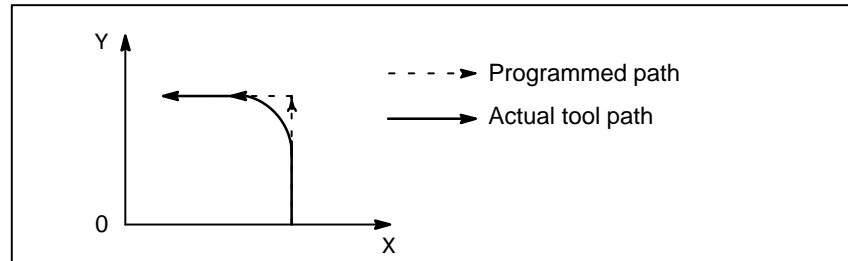


Fig. 5.1 (b) Example of Tool Path between Two Blocks

In circular interpolation, a radial error occurs (Fig. 5.1(c)).

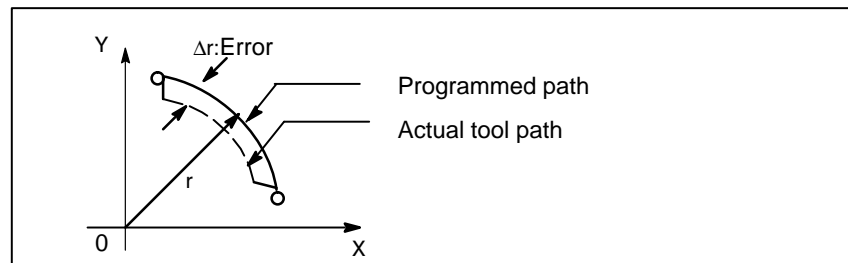


Fig. 5.1 (c) Example of Radial Error in Circular Interpolation

The rounded-corner path shown in Fig. 5.1(b) and the error shown in Fig. 5.1(c) depend on the feedrate. So, the feedrate needs to be controlled for the tool to move as programmed.

5.2 RAPID TRAVERSE

Format

```
G00 IP_ ;
```

G00 : G code (group 01) for positioning (rapid traverse)
IP_ ; Dimension word for the end point

Explanations

The positioning command (G00) positions the tool by rapid traverse. In rapid traverse, the next block is executed after the specified feedrate becomes 0 and the servo motor reaches a certain range set by the machine tool builder (in-position check).

A rapid traverse rate is set for each axis by parameter No. 1420, so no rapid traverse feedrate need be programmed.

The following overrides can be applied to a rapid traverse rate with the switch on the machine operator's panel:F0, 25, 50, 100%

F0: Allows a fixed feedrate to be set for each axis by parameter No. 1421. For detailed information, refer to the appropriate manual of the machine tool builder.

5.3 CUTTING FEED

Feedrate of linear interpolation (G01), circular interpolation (G02, G03), etc. are commanded with numbers after the F code.

In cutting feed, the next block is executed so that the feedrate change from the previous block is minimized.

Four modes of specification are available:

1. Feed per minute (G94)
After F, specify the amount of feed of the tool per minute.
2. Feed per revolution (G95)
After F, specify the amount of feed of the tool per spindle revolution.
3. Inverse time feed (G93)
Specify the inverse time (FRN) after F.
4. F1-digit feed
Specify a desired one-digit number after F. Then, the feedrate set with the CNC for that number is set.

Format

<p>Feed per minute G94 ; G code (group 05) for feed per minute F_ ; Feedrate command (mm/min or inch/min)</p> <p>Feed per revolution G95 ; G code (group 05) for feed per revolution F_ ; Feedrate command (mm/rev or inch/rev)</p> <p>Inverse time feed (G93) G93 ; Inverse time feed command G code (05 group) F_ ; Feedrate command (1/min)</p> <p>F1-digit feed FN ; N : Number from 1 to 9</p>

Explanations

- **Tangential speed constant control**

Cutting feed is controlled so that the tangential feedrate is always set at a specified feedrate.

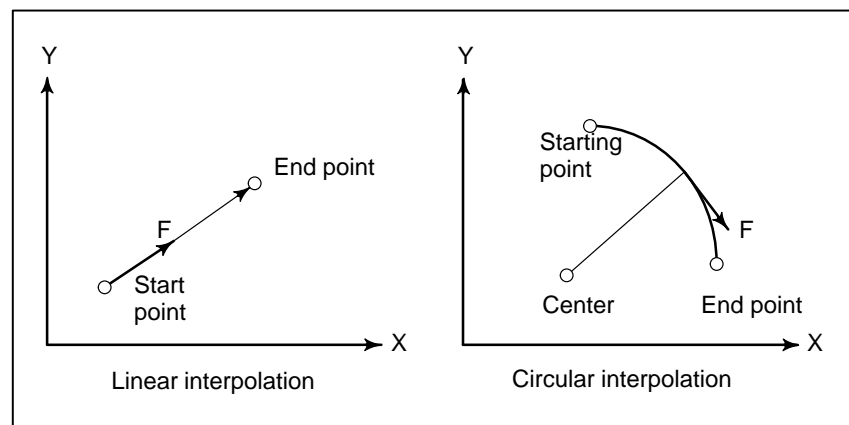


Fig. 5.3 (a) Tangential feedrate (F)

- **Feed per minute (G94)**

After specifying G94 (in the feed per minute mode), the amount of feed of the tool per minute is to be directly specified by setting a number after F. G94 is a modal code. Once a G94 is specified, it is valid until G95 (feed per revolution) is specified. At power-on, the feed per minute mode is set.

An override from 0% to 254% (in 1% steps) can be applied to feed per minute with the switch on the machine operator's panel. For detailed information, see the appropriate manual of the machine tool builder.

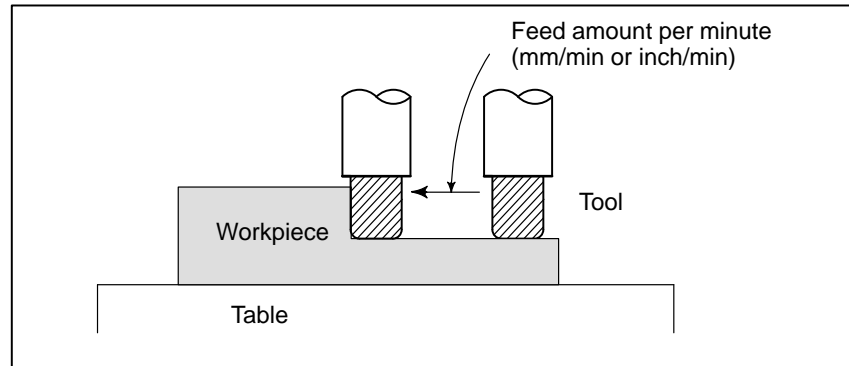


Fig. 5.3 (b) Feed per minute

WARNING

No override can be used for some commands such as for threading.

- **Feed per revolution (G95)**

After specifying G95 (in the feed per revolution mode), the amount of feed of the tool per spindle revolution is to be directly specified by setting a number after F. G95 is a modal code. Once a G95 is specified, it is valid until G94 (feed per minute) is specified.

An override from 0% to 254% (in 1% steps) can be applied to feed per revolution with the switch on the machine operator's panel. For detailed information, see the appropriate manual of the machine tool builder.

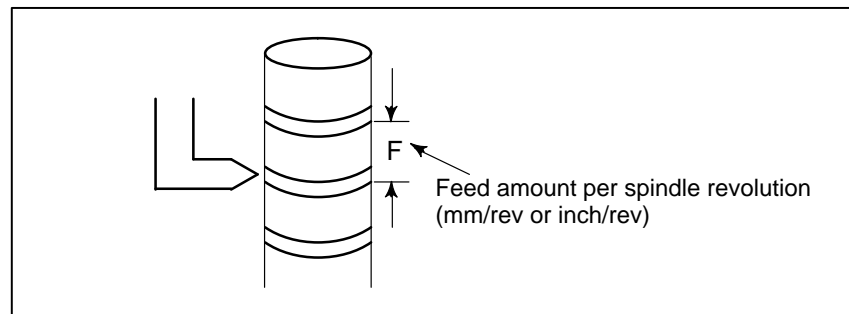


Fig. 5.3 (c) Feed per revolution

CAUTION

When the speed of the spindle is low, feedrate fluctuation may occur. The slower the spindle rotates, the more frequently feedrate fluctuation occurs.

- **Inverse time feed (G93)**

When G93 is specified, the inverse time specification mode (G93 mode) is set. Specify the inverse time (FRN) with an F code.

A value from 0.001 to 9999.999 can be specified as FRN, regardless of whether the input mode is inches or metric, or the increment system is IS-B or IS-C.

F code specification value	FRN
F1	0.001
F1 *1	1.000
F1.0	1.000
F9999999	9999.999
F9999 *1	9999.000
F9999.999	9999.999

NOTE

*1 Value specified in fixed-point format with bit 0 (DPI) of parameter No. 3401 set to 1

Explanations**For linear interpolation (G01)**

$$FRN = \frac{1}{\text{time (min)}} = \frac{\text{feedrate}}{\text{distance}}$$

Feedrate: mm/min (for metric input)
inch/min (for inch input)
Distance: mm (for metric input)
inch (for inch input)

To end a block in 1 (min)

$$FRN = \frac{1}{\text{time (min)}} = \frac{1}{1 \text{ (min)}} = 1 \quad \text{Specify F1.0.}$$

To end a block in 10 (sec)

$$FRN = \frac{1}{\text{time (sec) / 60}} = \frac{1}{10/60 \text{ (sec)}} = 6 \quad \text{Specify F6.0.}$$

To find the movement time required when F0.5 is specified

$$\text{Time (min)} = \frac{1}{FRN} = \frac{1}{0.5} = 2 \quad 2 \text{ (min) is required.}$$

To find the movement time required when F10.0 is specified

$$\text{Time (sec)} = \frac{1 \times 60}{FRN} = \frac{60}{10} = 6 \quad 6 \text{ (sec) is required.}$$

For circular interpolation (G01)

$$FRN = \frac{1}{\text{time (min)}} = \frac{\text{feedrate}}{\text{arc radius}}$$

Feedrate: mm/min (for metric input)
inch/min (for inch input)
Arc radius: mm (for metric input)
inch (for inch input)

NOTE

In the case of circular interpolation, the feedrate is calculated not from the actual amount of movement in the block but from the arc radius.

G93 is a modal G code and belongs to group 05 (includes G95 (feed per revolution) and G94 (feed per minute)).

When an F value is specified in G93 mode and the feedrate exceeds the maximum cutting feedrate, the feedrate is clamped to the maximum cutting feedrate.

In the case of circular interpolation, the feedrate is calculated not from the actual amount of movement in the block but from the arc radius. This means that actual machining time is longer when the arc radius is longer than the arc distance and shorter when the arc radius is shorter than the arc distance. Inverse time feed can also be used for cutting feed in a canned cycle. Notes

NOTE

- 1 In the G93 mode, an F code is not handled as a modal code and therefore needs to be specified in each block. If an F code is not specified, P/S alarm (No. 11 (indicating that cutting feedrate specification is missing)) is issued.
- 2 When F0 is specified in G93 mode, P/S alarm (No. 11 (indicating that cutting feedrate specification is missing)) is issued.
- 3 Inverse time feed cannot be used when PMC axis control is in effect.
- 4 If the calculated cutting feedrate is smaller than the allowable range, P/S alarm (No. 11 (indicating that cutting feedrate specification is missing)) is issued.

- **One-digit F code feed**

When a one-digit number from 1 to 9 is specified after F, the feedrate set for that number in a parameter (Nos. 1451 to 1459) is used. When F0 is specified, the rapid traverse rate is applied.

The feedrate corresponding to the number currently selected can be increased or decreased by turning on the switch for changing F1-digit feedrate on the machine operator's panel, then by rotating the manual pulse generator.

The increment/decrement, ΔF , in feedrate per scale of the manual pulse generator is as follows:

$$\Delta F = \frac{F_{\max}}{100X}$$

F_{\max} : feedrate upper limit for F1-F4 set by parameter (No.1460), or feedrate upper limit for F5-F9 set by parameter (No.1461)

X : any value of 1-127 set by parameter (No.1450)

The feedrate set or altered is kept even while the power is off. The current feed rate is displayed on the CRT screen.

- **Cutting feedrate clamp**

A common upper limit can be set on the cutting feedrate along each axis with parameter No. 1422. If an actual cutting feedrate (with an override applied) exceeds a specified upper limit, it is clamped to the upper limit. Parameter No. 1430 can be used to specify the maximum cutting feedrate for each axis only for linear interpolation and circular interpolation. When the cutting feedrate along an axis exceeds the maximum feedrate for the axis as a result of interpolation, the cutting feedrate is clamped to the maximum feedrate.

NOTE

An upper limit is set in mm/min or inch/min. CNC calculation may involve a feedrate error of $\pm 2\%$ with respect to a specified value. However, this is not true for acceleration/deceleration. To be more specific, this error is calculated with respect to a measurement on the time the tool takes to move 500 mm or more during the steady state:

Reference

See Appendix C for range of feedrate command value.

5.4 CUTTING FEEDRATE CONTROL

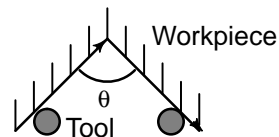
Cutting feedrate can be controlled, as indicated in Table 5.4(a).

Table 5.4(a) Cutting Feedrate Control

Function name		G code	Validity of G code	Description
Exact stop		G09	This function is valid for specified blocks only.	The tool is decelerated at the end point of a block, then an in-position check is made. Then the next block is executed.
Exact stop mode		G61	Once specified, this function is valid until G62, G63, or G64 is specified.	The tool is decelerated at the end point of a block, then an in-position check is made. Then the next block is executed.
Cutting mode		G64	Once specified, this function is valid until G61, G62, or G63 is specified.	The tool is not decelerated at the end point of a block, but the next block is executed.
Tapping mode		G63	Once specified, this function is valid until G61, G62, or G64 is specified.	The tool is not decelerated at the end point of a block, but the next block is executed. When G63 is specified, feedrate override and feed hold are invalid.
Auto- matic	Automatic override for inner corners	G62	Once specified, this function is valid until G61, G63, or G64 is specified.	When the tool moves along an inner corner during cutter compensation, override is applied to the cutting feedrate to suppress the amount of cutting per unit of time so that a good surface finish can be produced.
	Internal circular cutting feedrate change	—	This function is valid in the cutter compensation mode, regardless of the G code.	The internal circular cutting feedrate is changed.

NOTE

- 1 The purpose of in-position check is to check that the servo motor has reached within a specified range (specified with a parameter by the machine tool builder).
In-position check is not performed when bit 5 (NCI) of parameter No. 1601 is set to 1.
- 2 Inner corner angle θ : $2^\circ < \theta \leq \alpha \leq 178^\circ$
(α is a set value)



Format

Exact stop	G09 IP_ ;
Exact stop mode	G61 ;
Cutting mode	G64 ;
Tapping mode	G63 ;
Automatic corner override	G62 ;

5.4.1

Exact Stop (G09, G61)

Cutting Mode (G64)

Tapping Mode (G63)

Explanations

The inter-block paths followed by the tool in the exact stop mode, cutting mode, and tapping mode are different (Fig. 5.4.1 (a)).

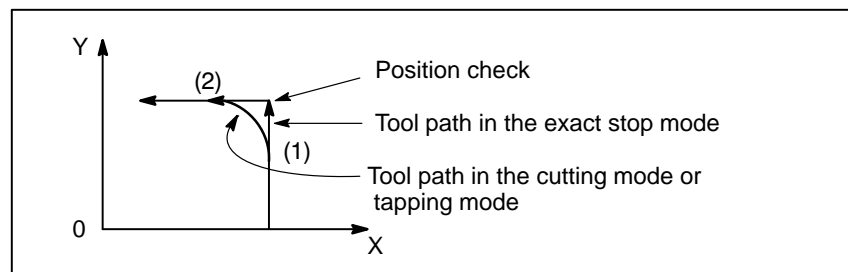


Fig. 5.4.1 (a) Example of Tool Paths from Block (1) to Block (2)

CAUTION

The cutting mode (G64 mode) is set at power-on or system clear.

5.4.2 Automatic Corner Override

When cutter compensation is performed, the movement of the tool is automatically decelerated at an inner corner and internal circular area. This reduces the load on the cutter and produces a smoothly machined surface.

5.4.2.1 Automatic Override for Inner Corners (G62)

Explanations

- **Override condition**

When G62 is specified, and the tool path with cutter compensation applied forms an inner corner, the feedrate is automatically overridden at both ends of the corner.

There are four types of inner corners (Fig. 5.4.2.1 (a)).

$2, \leq \theta \leq \theta_p \leq 178$, in Fig. 5.4.2.1 (a)

θ_p is a value set with parameter No. 1711. When θ is approximately equal to θ_p , the inner corner is determined with an error of 0.001, or less.

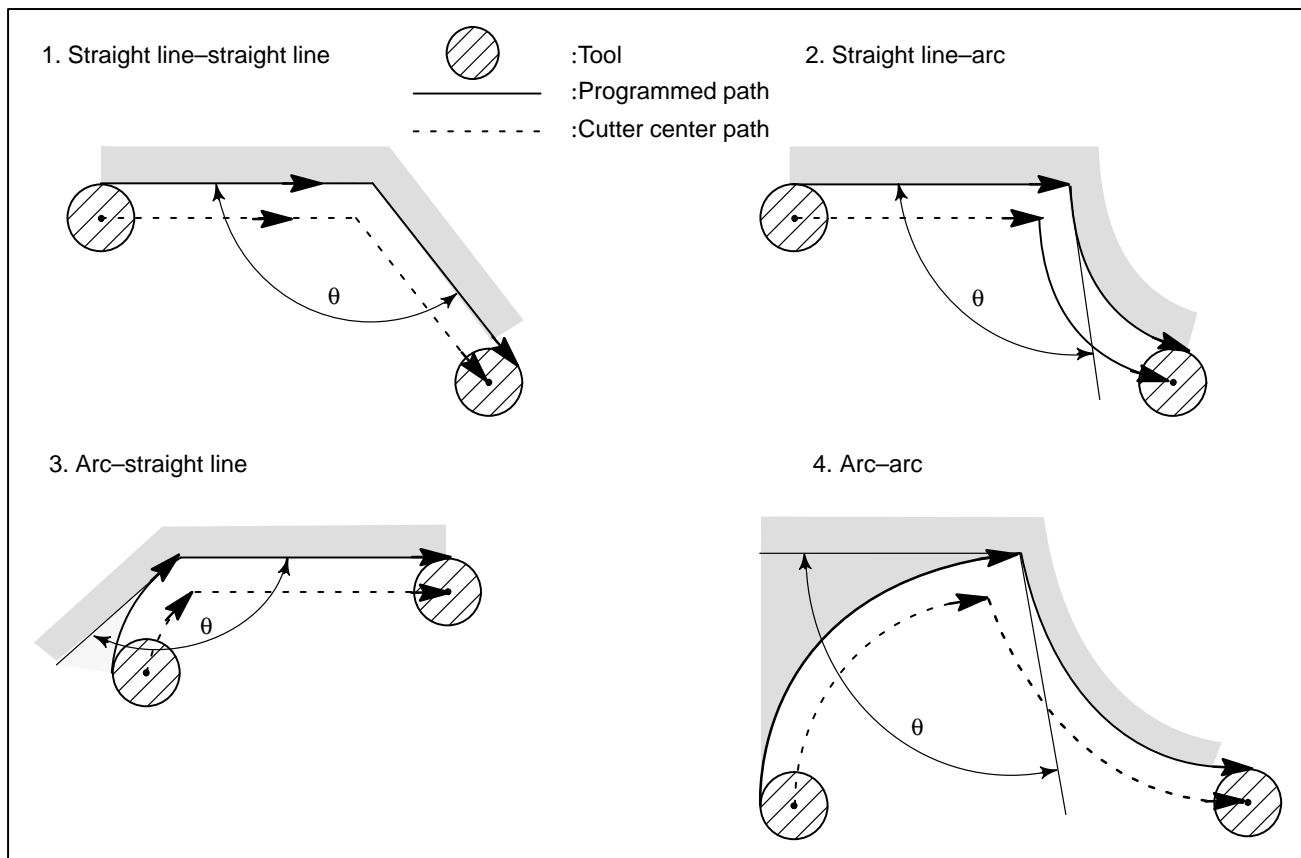


Fig. 5.4.2.1 (a) Inner corner

Override range

When a corner is determined to be an inner corner, the feedrate is overridden before and after the inner corner. The distances L_s and L_e , where the feedrate is overridden, are distances from points on the cutter center path to the corner (Fig. 5.4.2.1 (b), Fig. 5.4.2.1 (c), Fig. 5.4.2.1 (d)). L_s and L_e are set with parameter Nos. 1713 and 1714.

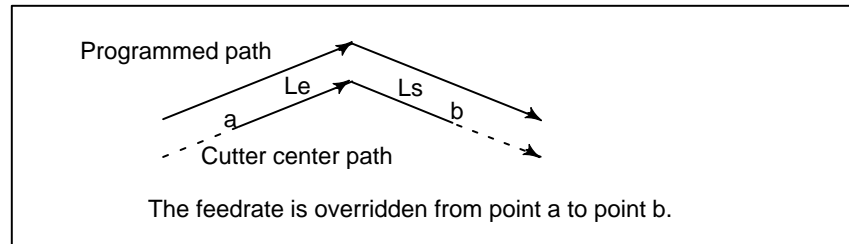


Fig. 5.4.2.1 (b) Override Range (Straight Line to Straight Line)

When a programmed path consists of two arcs, the feedrate is overridden if the start and end points are in the same quadrant or in adjacent quadrants (Fig. 5.4.2.1 (c)).

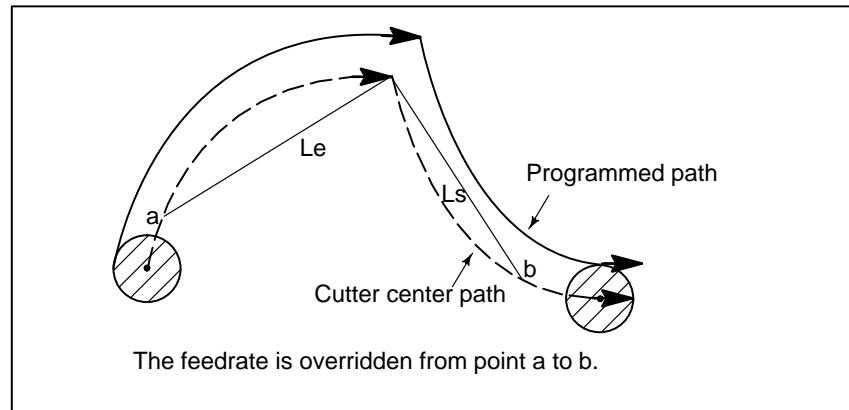


Fig. 5.4.2.1 (c) Override Range (Arc to Arc)

Regarding program (2) of an arc, the feedrate is overridden from point a to point b and from point c to point d (Fig. 5.4.2.1 (d)).

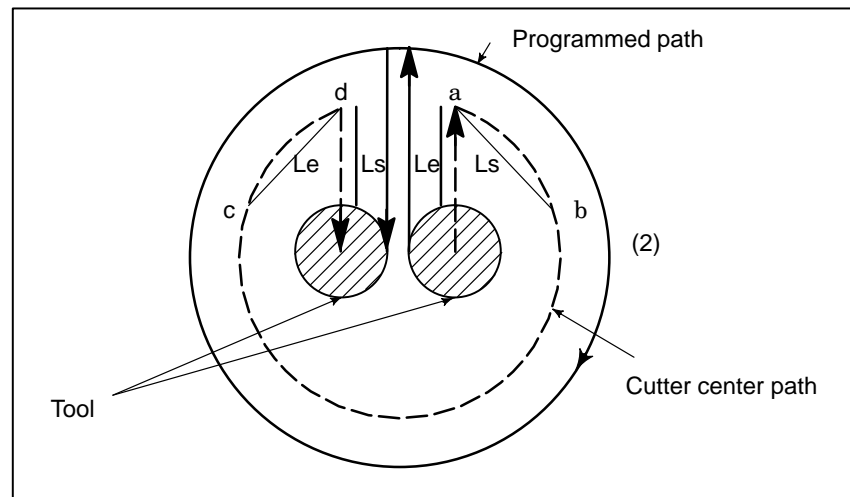


Fig. 5.4.2.1 (d) Override Range (Straight Line to Arc, Arc to Straight Line)

Override value

An override value is set with parameter No. 1712. An override value is valid even for dry run and F1-digit specification.

In the feed per minute mode, the actual feedrate is as follows:

$$F \times (\text{automatic override for inner corners}) \times (\text{feedrate override})$$

Limitations

- **Acceleration/deceleration before interpolation**
- **Start-up/G41, G42**
- **Offset**

Override for inner corners is disabled during acceleration/deceleration before interpolation.

Override for inner corners is disabled if the corner is preceded by a start-up block or followed by a block including G41 or G42.

Override for inner corners is not performed if the offset is zero.

5.4.2.2 Internal Circular Cutting Feedrate Change

For internally offset circular cutting, the feedrate on a programmed path is set to a specified feedrate (F) by specifying the circular cutting feedrate with respect to F, as indicated below (Fig. 5.4.2.2). This function is valid in the cutter compensation mode, regardless of the G62 code.

$$F \times \frac{Rc}{Rp}$$

Rc : Cutter center path radius
Rp : Programmed radius

It is also valid for the dry run and the one-digit F command.

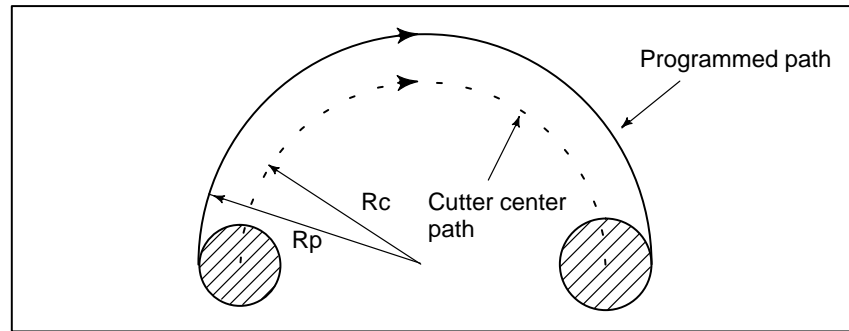


Fig. 5.4.2.2 Internal circular cutting feedrate change

If Rc is much smaller than Rp, $Rc/Rp \approx 0$; the tool stops. A minimum deceleration ratio (MDR) is to be specified with parameter No. 1710. When $Rc/Rp \leq MDR$, the feedrate of the tool is $(F \times MDR)$.

NOTE

When internal circular cutting must be performed together with override for inner corners, the feedrate of the tool is as follows:

$$F \times \frac{Rc}{Rp} \times (\text{override for the inner corners}) \times (\text{feedrate override})$$

5.4.3 AUTOMATIC CORNER DECELERATION

This function automatically controls the feedrate at a corner according to the corner angle between the machining blocks or the feedrate difference between the blocks along each axis.

This function is effective when ACD, bit 6 of parameter No. 1601, is set to 1, the system is in G64 mode (machining mode), and a cutting-feed block (block A) is followed by another cutting-feed block (block B).

The feedrate between machining blocks is controlled according to the corner angle between the blocks or the feedrate difference between the blocks along each axis. These two methods can be switched with CSD, bit 4 of parameter No. 1602.

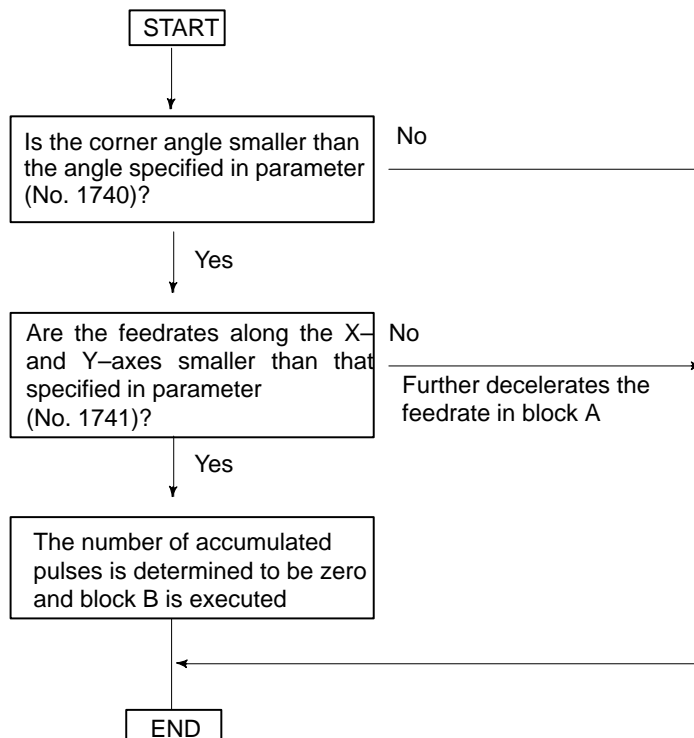
5.4.3.1 Corner deceleration according to the corner angle

This function decelerates the feedrate when the angle between blocks A and B on the selected plane is smaller than the angle specified in parameter No. 1740. The function executes block B when the feedrates along both the first and second axes are smaller than the feedrate specified in parameter No. 1741. In this case, the function determines that the number of accumulated pulses is zero.

Explanations

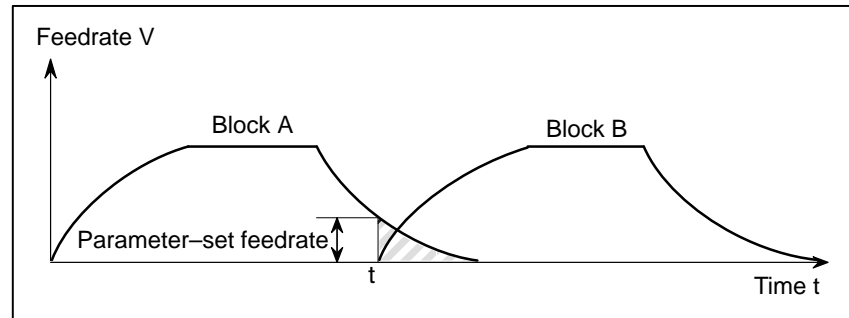
- Flowchart for feedrate control

The flowchart for feedrate control is shown below.



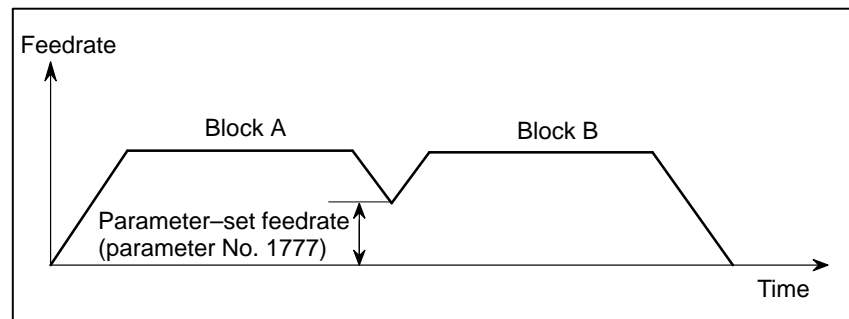
- **Feedrate and time**

When the corner angle is smaller than the angle specified in the parameter, the relationship between the feedrate and time is as shown below. Although accumulated pulses equivalent to the hatched area remain at time t , the next block is executed because the feedrate of the automatic acceleration/deceleration circuit is smaller than the parameter-set value. This function is effective only for movement on the selected plane.



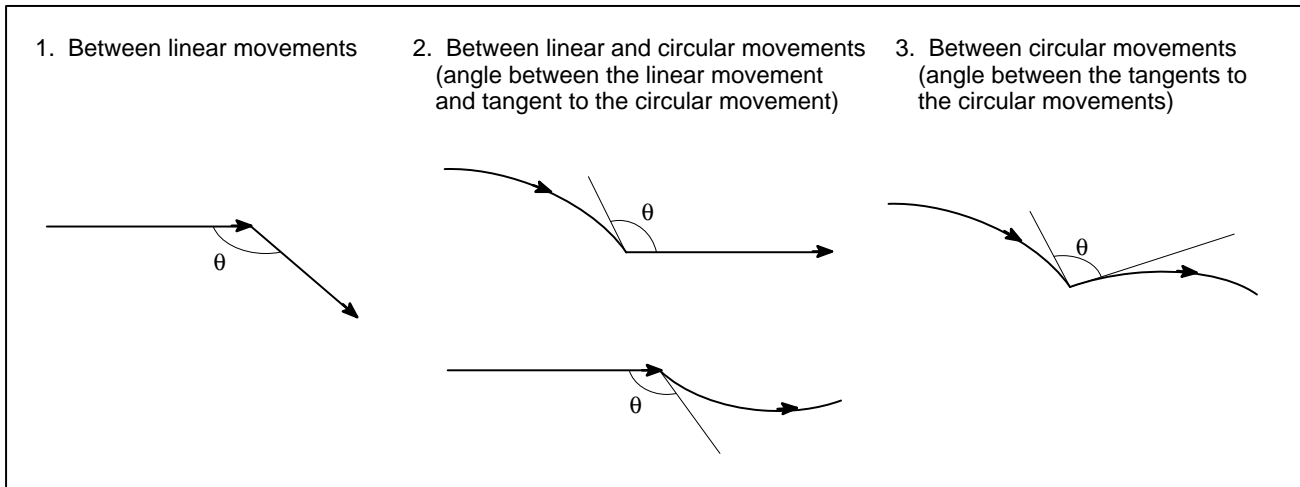
- **Acceleration/ deceleration before interpolation**

When acceleration/deceleration before interpolation is effective, the relationship between the feedrate and time is as shown below. When the angle between blocks A and B on the selected plane is smaller than the angle specified in parameter (No. 1740), and the feedrates specified in blocks A and B are larger than that specified in parameter (No. 1777), the feedrate is decelerated to the parameter-set value in block A, and accelerated to the feedrate specified in block B. The acceleration depends on the parameter for acceleration/deceleration before interpolation.



- **Angle between two blocks**

The angle between two blocks (blocks A and B) is assumed to be angle θ , as shown below.



- **Selected plane**

The machining angle is compared with the angle specified in parameter (No. 1740) for movements on the selected plane only. Machining feedrates are compared with that specified in parameter (No. 1741) for movement along the first and second axes on the selected plane only. This means, when movement occurs along three or more axes, only that movement along the first and second axes on the selected plane is considered.

- **Corner roundness**

Corner roundness is determined by the angle and feedrate specified in parameter (Nos. 1740 and 1741). To always make a sharp corner, set the angle to zero and the feedrate to 180000 (equivalent to 180 degrees).

- **Exact stop**

When G90 (exact stop) is specified, exact stop is performed irrespective of the angle and feedrate specified in parameter (Nos. 1740 and 1741).

- **Look-ahead control**

Those parameters related to automatic corner deceleration in look-ahead control mode are shown below.

Parameter description	Normal mode	Look-ahead control mode
Switching the methods for automatic corner deceleration	No.1602#4	←
Lower limit of feedrate in automatic corner deceleration based on the angle	No.1777	No.1778
Limit angle in corner deceleration based on the angle	No.1740	No.1779

Limitations

This function cannot be enabled for a single block or during dry run.

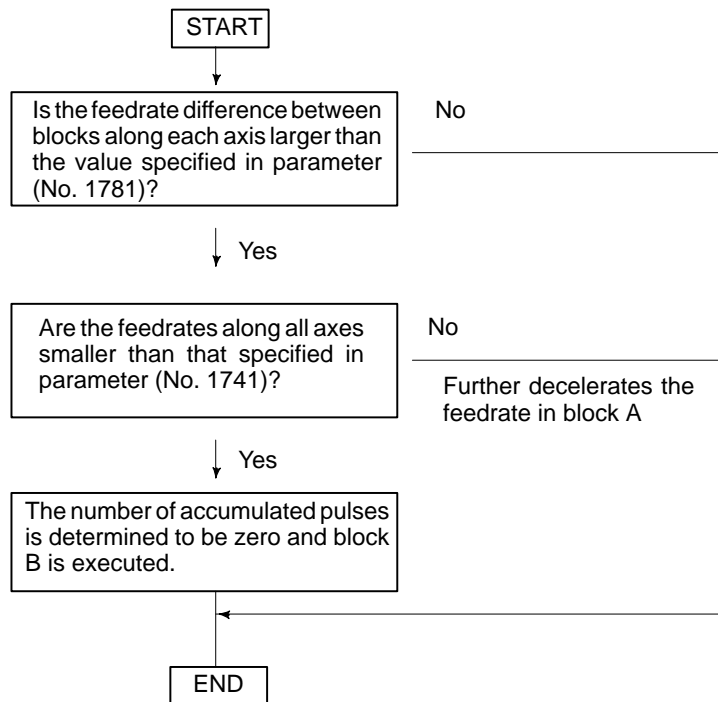
**5.4.3.2
Corner deceleration
according to the feedrate
difference between
blocks along each axis**

This function decelerates the feedrate when the difference between the feedrates at the end point of block A and the start point of block B along each axis is larger than the value specified in parameter No. 1781. The function executes block B when the feedrates along all axes are smaller than the feedrate specified in parameter No. 1741. In this case, the function determines that the number of accumulated pulses is zero.

Explanations

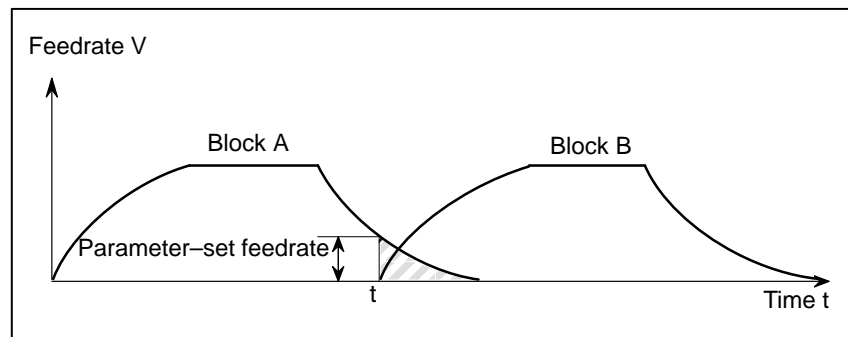
- **Flowchart for feedrate control**

The flowchart for feedrate control is shown below.



- **Feedrate and time**

When the feedrate difference between blocks along each axis is larger than the value specified in parameter No. 1781, the relationship between the feedrate and time is as shown below. Although accumulated pulses equivalent to the hatched area remain at time t, the next block is executed because the feedrate of the automatic acceleration/deceleration circuit is smaller than the feedrate specified in parameter No. 1741.



- **Acceleration / deceleration before interpolation**

When acceleration/deceleration before interpolation is effective, the relationship between the feedrate and time is as described below.

When the feedrate difference between blocks A and B along each axis is larger than the value specified in parameter No. 1780, the feedrate is decelerated to the corner feedrate calculated from the feedrate difference along each axis.

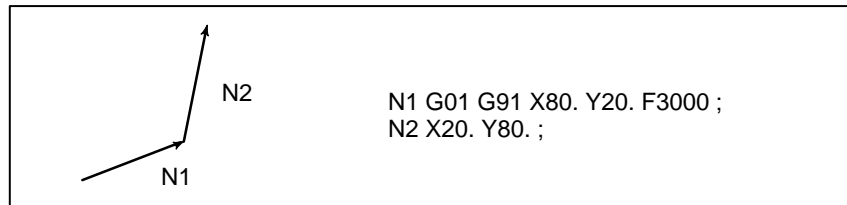
Let the feedrate be F. Compare the feedrate difference along each axis (Vc[X], Vc[Y], ...) with the value specified in parameter No. 1780, Vmax. When the difference exceeds Vmax, calculate R as shown below.

$$R = \frac{Vc}{Vmax}$$

Find the maximum value for R among the calculated values for the axes. Let it be Rmax. Then, the corner feedrate can be obtained as follows:

$$Fc = F \times \frac{1}{Rmax}$$

(Example)

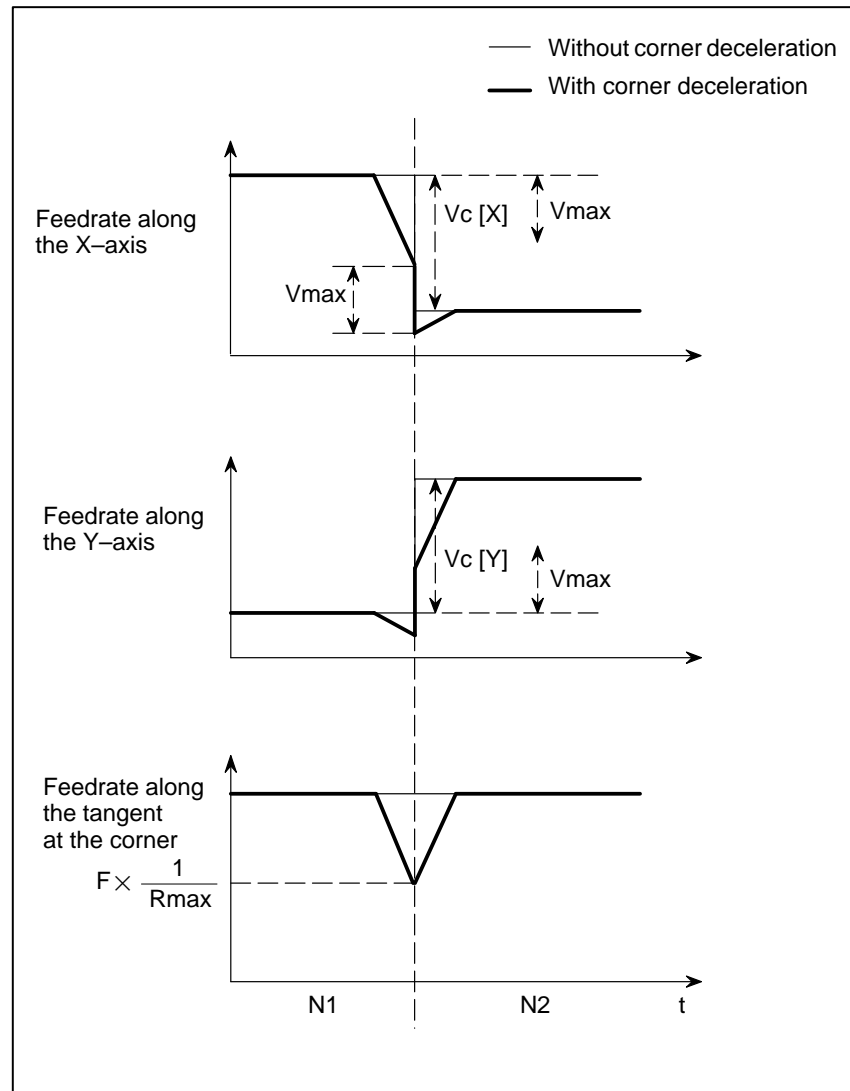


When this movement is specified, the feedrate along each axis is as shown in the next figure.

$$Rmax = \frac{Vc [X(Y)]}{Vmax}$$

$$F \times \frac{1}{Rmax}$$

From the figure, it can be seen that the feedrate differences along the X- and Y-axes (Vc[X] and Vc[Y]) exceed Vmax. Calculate Rmax to get Fc. When the feedrate is decelerated to Fc at the corner, the feedrate difference along each axis do not exceed Vmax.



- **Setting the allowable feedrate difference along each axis**
- **Checking the feedrate difference**
- **Exact stop**
- **Override**

The allowable feedrate difference can be specified for each axis in parameter No. 1783.

The feedrate difference is also checked during dry-run operation or during deceleration caused by an external signal, using feedrate commands specified in a program.

When G90 (exact stop) is specified, exact stop is performed irrespective of the parameter settings.

If an override is changed during operation, the feedrate difference will not be checked correctly.

- **Look-ahead control**

Parameters related to automatic corner deceleration in look-ahead control mode are shown below.

Parameter description	Normal mode	Look-ahead control mode
Switching the methods for automatic corner deceleration	No.1602#4	No.1602#4
Allowable feedrate difference (for all axis) in automatic corner deceleration based on the feedrate difference	No.1780	No.1780
Allowable feedrate difference (for each axis) in automatic corner deceleration based on the feedrate difference	No.1783	No.1783

Limitations

This function is not effective for feed-per-rotation commands, address-F-with-one-digit commands, rigid tapping, and a single block.

5.5 DWELL (G04)

Format

Dwell G04 X_ ; or G04 P_ ;
 X_ : Specify a time (decimal point permitted)
 P_ : Specify a time (decimal point not permitted)

Explanations

By specifying a dwell, the execution of the next block is delayed by the specified time. In addition, a dwell can be specified to make an exact check in the cutting mode (G64 mode).

When neither P nor X is specified, exact stop is performed.

Bit 1 (DWL) of parameter No. 3405 can specify dwell for each rotation in feed per rotation mode (G95).

**Table 5.5 (a) Command value range of the dwell time
(Command by X)**


Increment system	Command value range	Dwell time unit
IS-B	0.001A99999.999	s
IS-C	0.0001A9999.9999	

**Table 5.5 (b) Command value range of the dwell time
(Command by P)**

Increment system	Command value range	Dwell time unit
IS-B	1A99999999	0.001 s
IS-C	1A99999999	0.0001 s

6

REFERENCE POSITION



A CNC machine tool has a special position where, generally, the tool is exchanged or the coordinate system is set, as described later. This position is referred to as a reference position.

6.1 REFERENCE POSITION RETURN

General

- **Reference position**

The reference position is a fixed position on a machine tool to which the tool can easily be moved by the reference position return function. For example, the reference position is used as a position at which tools are automatically changed. Up to four reference positions can be specified by setting coordinates in the machine coordinate system in parameters (No. 1240 to 1243).

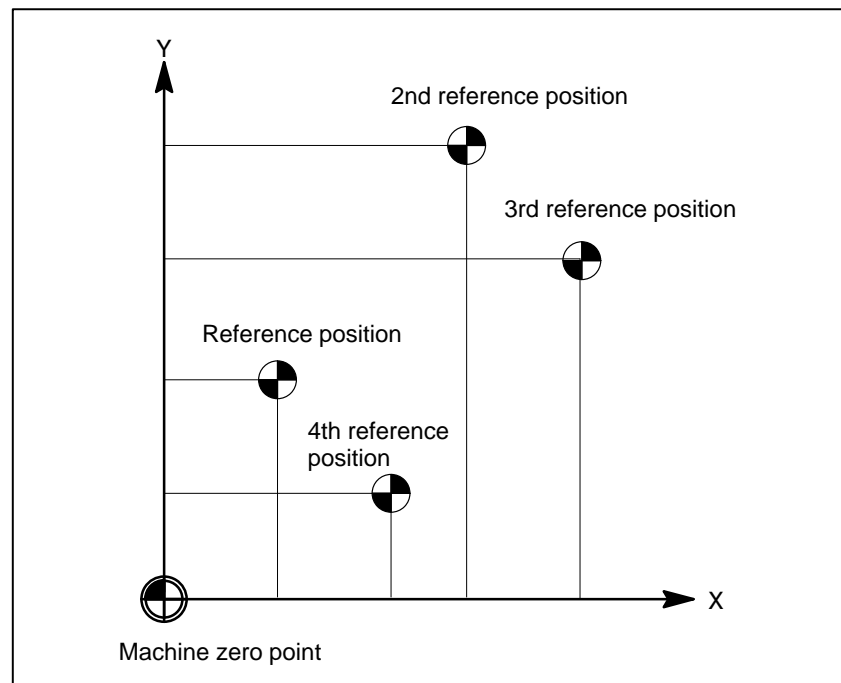


Fig. 6.1 (a) Machine zero point and reference positions

- **Reference position return and movement from the reference position**

Tools are automatically moved to the reference position via an intermediate position along a specified axis. Or, tools are automatically moved from the reference position to a specified position via an intermediate position along a specified axis. When reference position return is completed, the lamp for indicating the completion of return goes on.

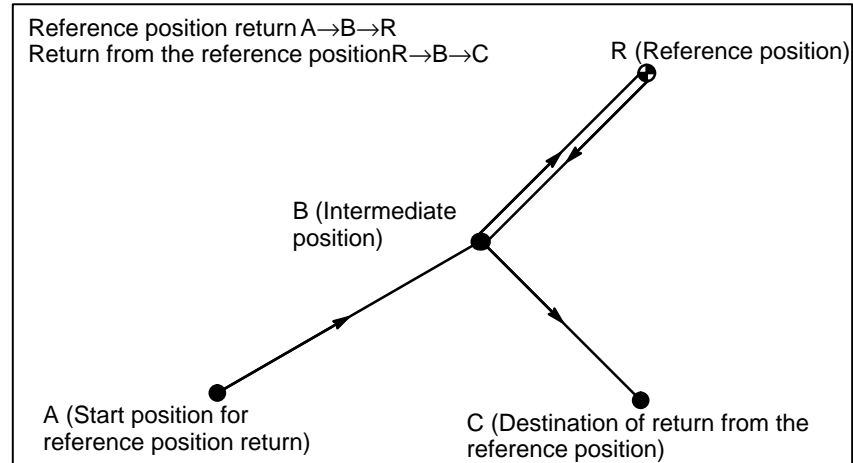


Fig. 6.1 (b) Reference position return and return from the reference position

- **Reference position return check**

The reference position return check (G27) is the function which checks whether the tool has correctly returned to the reference position as specified in the program. If the tool has correctly returned to the reference position along a specified axis, the lamp for the axis goes on.

Format

- **Reference position return**

G28 IP_ ; Reference position return
G30 P2 IP_ ; 2nd reference position return (P2 can be omitted.)
G30 P3 IP_ ; 3rd reference position return
G30 P4 IP_ ; 4th reference position return

IP : Command specifying the intermediate position
(Absolute/incremental command)

- **Return from reference position**

G29 IP_ ;

IP : Command specifying the destination of return from reference position (Absolute/incremental command)

- **Reference position return check**

G27 IP_ ;

IP : Command specifying the reference position
(Absolute/incremental command)

Explanations

- **Reference position return (G28)**

Positioning to the intermediate or reference positions are performed at the rapid traverse rate of each axis. Therefore, for safety, the cutter compensation, and tool length compensation should be cancelled before executing this command. The coordinates for the intermediate position are stored in the CNC only for the axes for which a value is specified in a G28 block. For the other axes, the previously specified coordinates are used.

Example N1 G28 X40.0 ; **Intermediate position (X40.0)**
 N2 G28 Y60.0 ; **Intermediate position (X40.0, Y60.0)**
- **2nd, 3rd, and 4th reference position return (G30)**

In a system without an absolute-position detector, the first, third, and fourth reference position return functions can be used only after the reference position return (G28) or manual reference position return (see III-3.1) is made. The G30 command is generally used when the automatic tool changer (ATC) position differs from the reference position.
- **Return from the reference position (G29)**

In general, it is commanded immediately following the G28 command or G30. For incremental programming, the command value specifies the incremental value from the intermediate point. Positioning to the intermediate or reference points are performed at the rapid traverse rate of each axis. When the workpiece coordinate system is changed after the tool reaches the reference position through the intermediate point by the G28 command, the intermediate point also shifts to a new coordinate system. If G29 is then commanded, the tool moves to the commanded position through the intermediate point which has been shifted to the new coordinate system. The same operations are performed also for G30 commands.
- **Reference position return check (G27)**

G27 command positions the tool at rapid traverse rate. If the tool reaches the reference position, the reference position return lamp lights up. However, if the position reached by the tool is not the reference position, an alarm (No. 092) is displayed.
- **Setting of the reference position return feedrate**

Before a machine coordinate system is established with the first reference position return after power-on, the manual and automatic reference position return feedrates and automatic rapid traverse rate conform to the setting of parameter No. 1428 for each axis. Even after a machine coordinate system is established upon the completion of reference position return, the manual reference position return feedrate conforms to the setting of the parameter.

NOTE

- 1 To this feedrate, a rapid traverse override (F0 ,25,50,100%) is applied, for which the setting is 100%.
- 2 After a machine coordinate system has been established upon the completion of reference position return, the automatic reference position return feedrate will conform to the ordinary rapid traverse rate.
- 3 For the manual rapid traverse rate used before a machine coordinate system is established upon the completion of reference position return a jog feedrate or manual rapid traverse rate can be selected using RPD (bit 0 of parameter No. 1401).

	Before a coordinate system is established	After a coordinate system is established
Automatic reference position return (G28)	No. 1428	No.1420
Automatic rapid traverse (G00)	No.1428	No.1420
Manual reference position return	No.1428	No.1428
Manual rapid traverse rate	No.1423 *1	No.1424

NOTE

When parameter No. 1428 is set to 0, the feedrates conform to the parameter settings shown below.

	Before a coordinate system is established	After a coordinate system is established
Automatic reference position return (G28)	No. 1420	No.1420
Automatic rapid traverse (G00)	No.1420	No.1420
Manual reference position return	No.1424	No.1424
Manual rapid traverse rate	No.1423 *1	No.1424

1420 : Rapid traverse rate

1423 : Jog feedrate

1424 : Manual rapid traverse rate

*1 Setting of parameter No.1424 when RPD (bit 0 of parameter No.1401) is set to 1.

Restrictions

- **Status the machine lock being turned on**
- **First return to the reference position after the power has been turned on (without an absolute position detector)**
- **Reference position return check in an offset mode**
- **Lighting the lamp when the programmed position does not coincide with the reference position**

The lamp for indicating the completion of return does not go on when the machine lock is turned on, even when the tool has automatically returned to the reference position. In this case, it is not checked whether the tool has returned to the reference position even when a G27 command is specified.

When the G28 command is specified when manual return to the reference position has not been performed after the power has been turned on, the movement from the intermediate point is the same as in manual return to the reference position.

In this case, the tool moves in the direction for reference position return specified in parameter ZMIx (bit 5 of No. 1006). Therefore the specified intermediate position must be a position to which reference position return is possible.

In an offset mode, the position to be reached by the tool with the G27 command is the position obtained by adding the offset value. Therefore, if the position with the offset value added is not the reference position, the lamp does not light up, but an alarm is displayed instead. Usually, cancel offsets before G27 is commanded.

When the machine tool system is an inch system with metric input, the reference position return lamp may also light up even if the programmed position is shifted from the reference position by the least setting increment. This is because the least setting increment of the machine tool system is smaller than its least command increment.

Reference

Manual reference position return

See III-3.1.

Examples

G28G90X1000.0Y500.0 ; (Programs movement from A to B)
T1111 ; (Changing the tool at the reference position)
G29X1300.0Y200.0 ; (Programs movement from B to C)

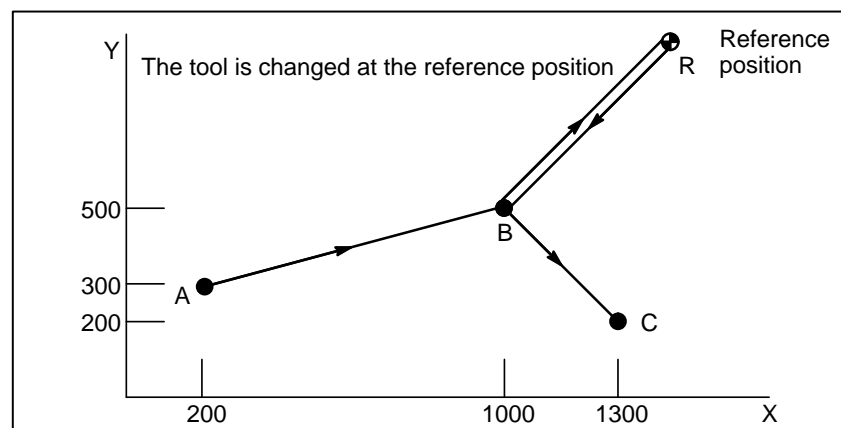


Fig. 6.1 (c) Reference position return and return from the reference position

6.2 FLOATING REFERENCE POSITION RETURN (G30.1)

Format

G30.1 IP_ ;

IP_ : Command of the intermediate position of the floating reference position
(Absolute command/incremental command)

Explanations

Generally speaking, on a machining center or milling machine, cutting tools can be replaced only at specific positions. A position where tools can be replaced is defined as the second or third reference point. Using G30 can easily move the cutting tools back to these points. On some machine tools, the cutting tools can be replaced at any position unless they interfere with the workpiece.

With these machines, the cutting tools should be replaced at a position as close to the workpiece as possible so as to minimize the machine cycle time. For this purpose, the tool change position is to be changed, depending on the figure of the workpiece. This operation can easily be performed using this function. That is, a tool change position suitable for the workpiece is memorized as a floating reference point. Then command G30.1 can easily cause return to the tool change position.

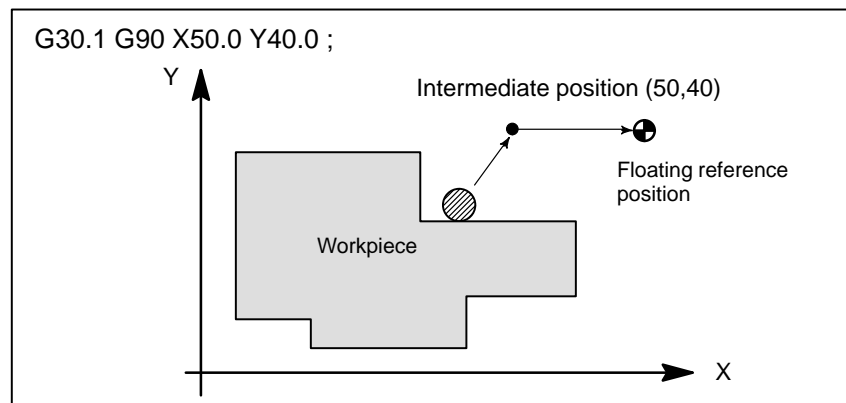
A floating reference point becomes a machine coordinate position memorized by pressing the soft key **[SET FRP]** on the current positions display screen (see III-11.1.7). The G30.1 block first positions the tool at the intermediate point along the specified axes at rapid traverse rate, then further moves the tool from the intermediate point to the floating reference point at rapid traverse rate.

Before using G30.1, cancel cutter compensation and tool length compensation.

A floating reference point is not lost even if power is turned off.

The function for returning from the reference position (G29) can be used for moving the tool from the floating reference position (see II-6).

Examples



7 COORDINATE SYSTEM

By teaching the CNC a desired tool position, the tool can be moved to the position. Such a tool position is represented by coordinates in a coordinate system. Coordinates are specified using program axes. When three program axes, the X-axis, Y-axis, and Z-axis, are used, coordinates are specified as follows:

X_Y_Z_

This command is referred to as a dimension word.

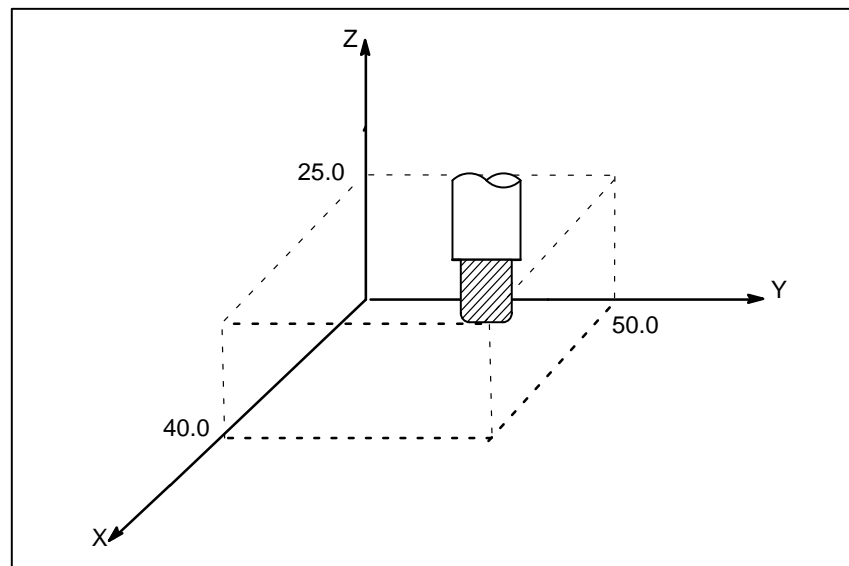


Fig. 7 Tool Position Specified by X40.0Y50.0Z25.0

Coordinates are specified in one of following three coordinate systems:

- (1) Machine coordinate system
- (2) Workpiece coordinate system
- (3) Local coordinate system

The number of the axes of a coordinate system varies from one machine to another. So, in this manual, a dimension word is represented as IP_.

7.1 MACHINE COORDINATE SYSTEM

The point that is specific to a machine and serves as the reference of the machine is referred to as the machine zero point. A machine tool builder sets a machine zero point for each machine.

A coordinate system with a machine zero point set as its origin is referred to as a machine coordinate system.

A machine coordinate system is set by performing manual reference position return after power-on (see III-3.1). A machine coordinate system, once set, remains unchanged until the power is turned off.

Format

(G90)G53 IP_ ;
IP_ ; Absolute dimension word

Explanations

- **Selecting a machine coordinate system (G53)**

When a command is specified the position on a machine coordinate system, the tool moves to the position by rapid traverse. G53, which is used to select a machine coordinate system, is a one-shot G code; that is, it is valid only in the block in which it is specified on a machine coordinate system. Specify an absolute command (G90) for G53. When an incremental command (G91) is specified, the G53 command is ignored. When the tool is to be moved to a machine-specific position such as a tool change position, program the movement in a machine coordinate system based on G53.

Restrictions

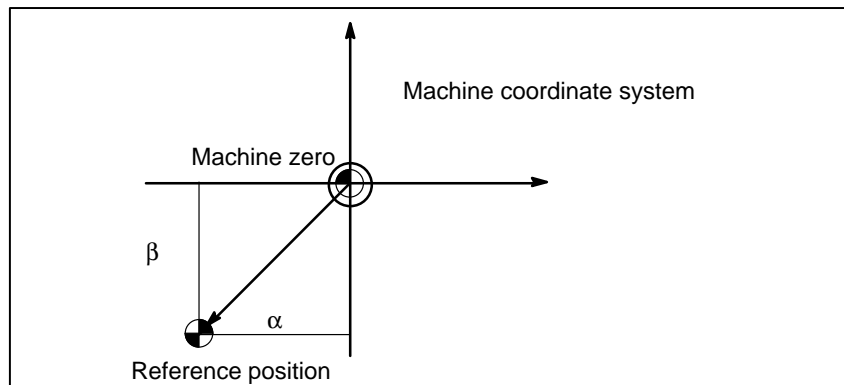
- **Cancel of the compensation function**
- **G53 specification immediately after power-on**

When the G53 command is specified, cancel the cutter compensation, tool length offset, and tool offset.

Since the machine coordinate system must be set before the G53 command is specified, at least one manual reference position return or automatic reference position return by the G28 command must be performed after the power is turned on. This is not necessary when an absolute-position detector is attached.

Reference

When manual reference position return is performed after power-on, a machine coordinate system is set so that the reference position is at the coordinate values of (α , β) set using parameter No.1240.



7.2 WORKPIECE COORDINATE SYSTEM

A coordinate system used for machining a workpiece is referred to as a workpiece coordinate system. A workpiece coordinate system is to be set with the CNC beforehand (setting a workpiece coordinate system).

A machining program sets a workpiece coordinate system (selecting a workpiece coordinate system).

A set workpiece coordinate system can be changed by shifting its origin (changing a workpiece coordinate system).

7.2.1 Setting a Workpiece Coordinate System

A workpiece coordinate system can be set using one of three methods:

(1) Method using G92

A workpiece coordinate system is set by specifying a value after G92 in the program.

(2) Automatic setting

If bit 0 of parameter SPR No. 1201 is set beforehand, a workpiece coordinate system is automatically set when manual reference position return is performed (see Part III-3.1.).

(3) Input using the CRT/MDI panel

Six workpiece coordinate systems can be set beforehand using the CRT/MDI panel (see Part III-11.4.6.).

When using an absolute command, establish the workpiece coordinate system in any of the above ways.

Format

- Setting a workpiece coordinate system by G92

(G90) G92 IP_

Explanations

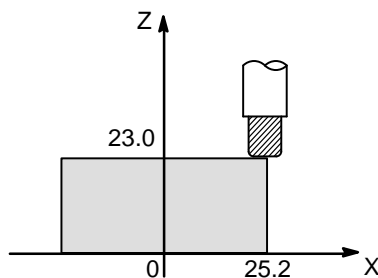
A workpiece coordinate system is set so that a point on the tool, such as the tool tip, is at specified coordinates. If a coordinate system is set using G92 during tool length offset, a coordinate system in which the position before offset matches the position specified in G92 is set.

Cutter compensation is cancelled temporarily with G92.

Examples

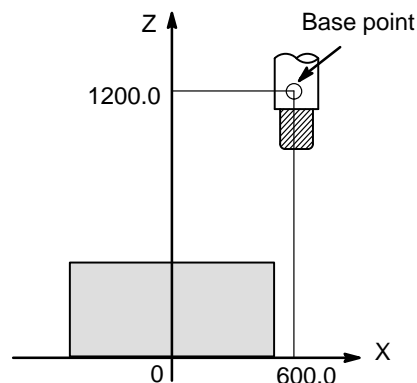
Example 1

Setting the coordinate system by the G92X25.2Z23.0; command
(The tool tip is the start point for the program.)



Example 2

Setting the coordinate system by the G92X600.0Z1200.0; command
(The base point on the tool holder is the start point for the program.)



If an absolute command is issued, the base point moves to the commanded position. In order to move the tool tip to the commanded position, the difference from the tool tip to the base point is compensated by tool length offset.

7.2.2 Selecting a Workpiece Coordinate System

The user can choose from set workpiece coordinate systems as described below. (For information about the methods of setting, see II- 7.2.1.)

- (1) Once a workpiece coordinate system is selected by G92 or automatic workpiece coordinate system setting, absolute commands work with the workpiece coordinate system.
- (2) Choosing from six workpiece coordinate systems set using the CRT/MDI panel

By specifying a G code from G54 to G59, one of the workpiece coordinate systems 1 to 6 can be selected.

G54 Workpiece coordinate system 1

G55 Workpiece coordinate system 2

G56 Workpiece coordinate system 3

G57 Workpiece coordinate system 4

G58 Workpiece coordinate system 5

G59 Workpiece coordinate system 6

Workpiece coordinate system 1 to 6 are established after reference position return after the power is turned on. When the power is turned on, G54 coordinate system is selected.

Examples

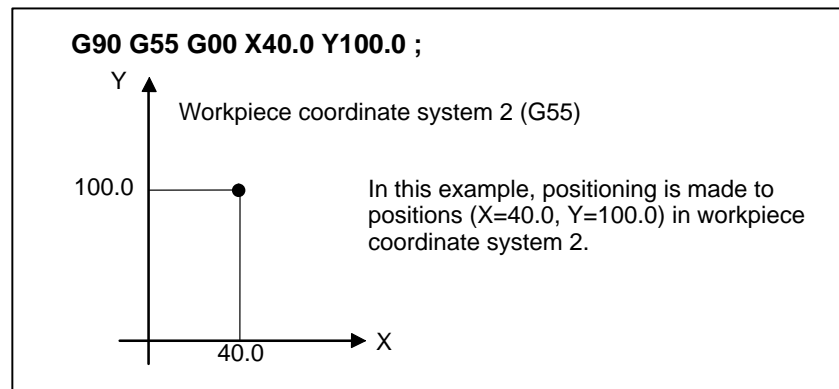


Fig. 7.2.2

7.2.3 Changing Workpiece Coordinate System

The six workpiece coordinate systems specified with G54 to G59 can be changed by changing an external workpiece zero point offset value or workpiece zero point offset value.

Three methods are available to change an external workpiece zero point offset value or workpiece zero point offset value.

- (1) Inputting from the MDI panel (see III-11.4.6)
- (2) Programming by G10 or G92
- (3) Using the external data input function

An external workpiece zero point offset value can be changed by input signal to CNC. Refer to machine tool builder's manual for details

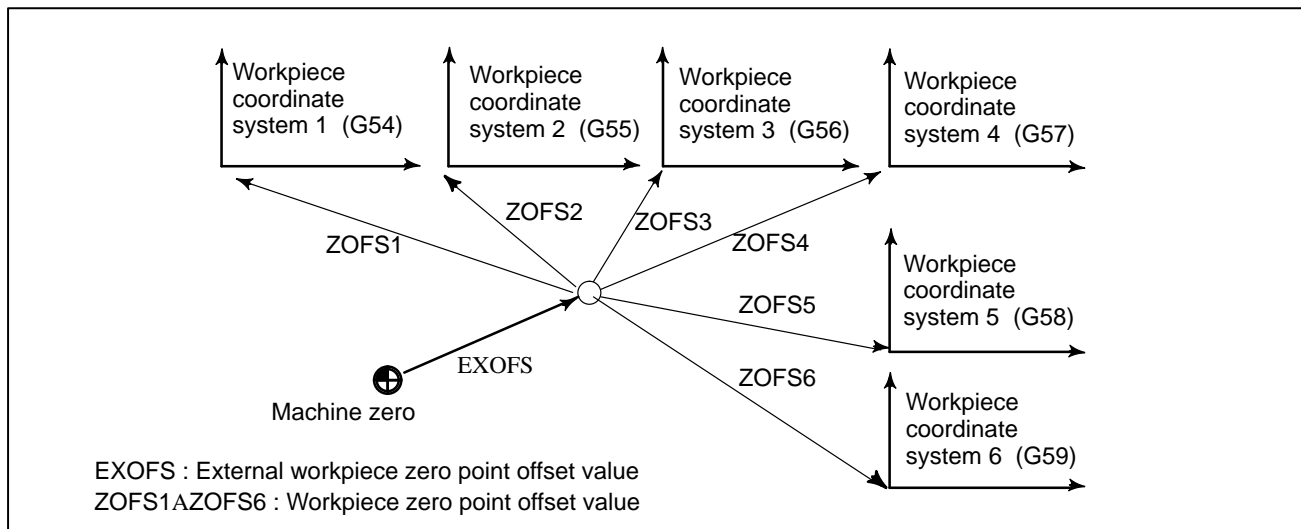


Fig. 7.2.3 Changing an external workpiece zero point offset value or workpiece zero point offset value

Format

● Changing by G10

G10 L2 Pp IP_;

p=0 : External workpiece zero point offset value

p=1 to 6 : Workpiece zero point offset value correspond to workpiece coordinate system 1 to 6

IP : For an absolute command (G90), workpiece zero point offset for each axis.

For an incremental command (G91), value to be added to the set workpiece zero point offset for each axis (the result of addition becomes the new workpiece zero point offset).

● Changing by G92

G92 IP_;

Explanations

- **Changing by G10**

With the G10 command, each workpiece coordinate system can be changed separately.

- **Changing by G92**

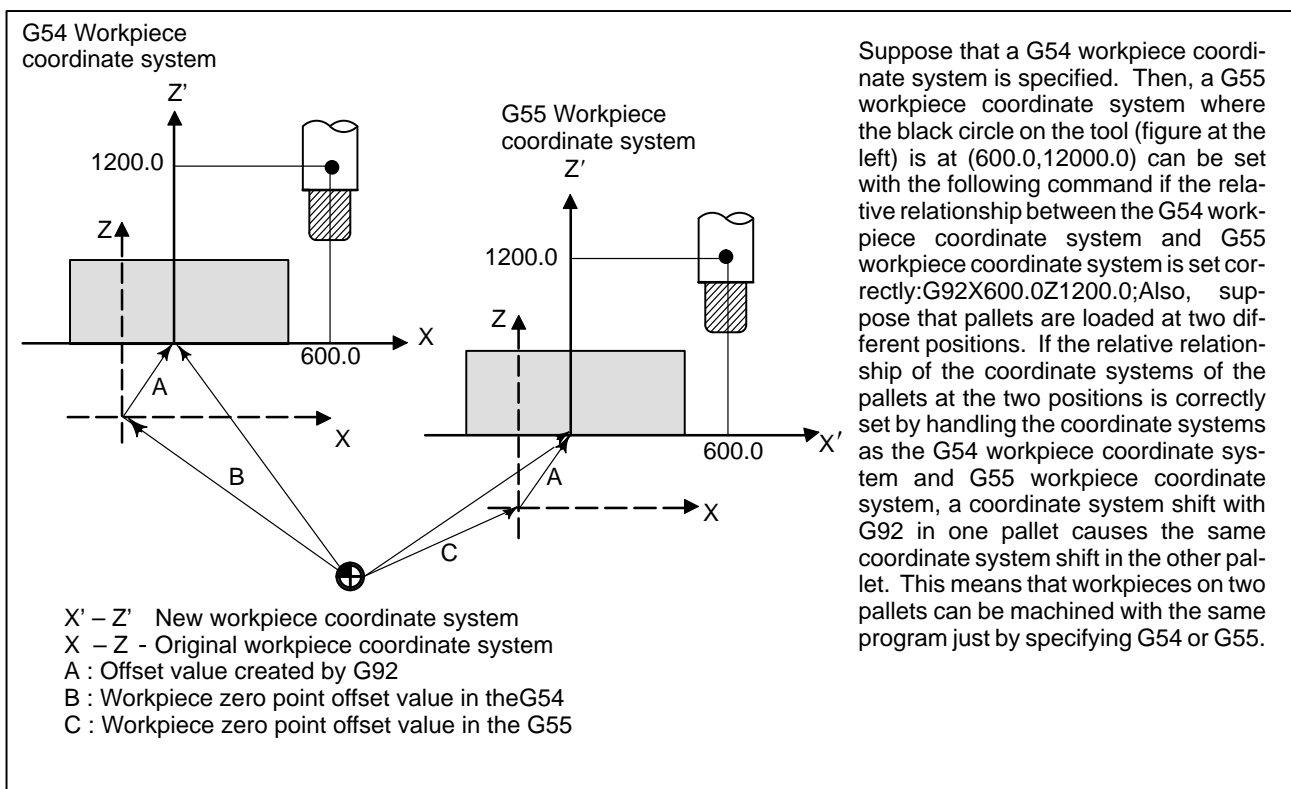
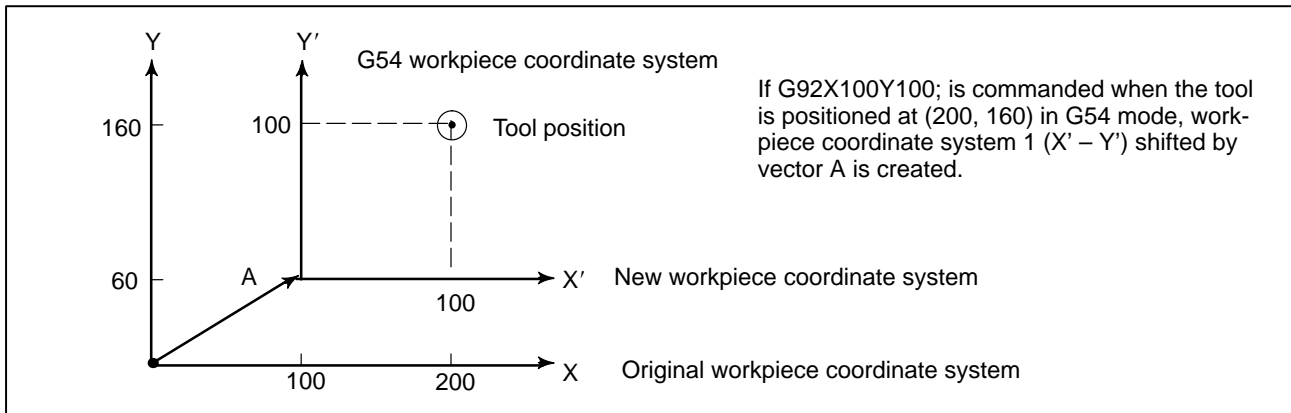
By specifying G92IP_;, a workpiece coordinate system (selected with a code from G54 to G59) is shifted to set a new workpiece coordinate system so that the current tool position matches the specified coordinates (P_).

Then, the amount of coordinate system shift is added to all the workpiece zero point offset values. This means that all the workpiece coordinate systems are shifted by the same amount.

WARNING

When a coordinate system is set with G92 after an external workpiece zero point offset value is set, the coordinate system is not affected by the external workpiece zero point offset value. When G92X100.0Z80.0; is specified, for example, the coordinate system having its current tool reference position at X = 100.0 and Z = 80.0 is set.

Examples



7.2.4 Workpiece coordinate system preset (G92.1)

The workpiece coordinate system preset function presets a workpiece coordinate system shifted by manual intervention to the pre-shift workpiece coordinate system. The latter system is displaced from the machine zero point by a workpiece zero point offset value.

There are two methods for using the workpiece coordinate system preset function. One method uses a programmed command (G92.1). The other uses MDI operations on the absolute position display screen, relative position display screen, and overall position display screen (III- 11.1.4).

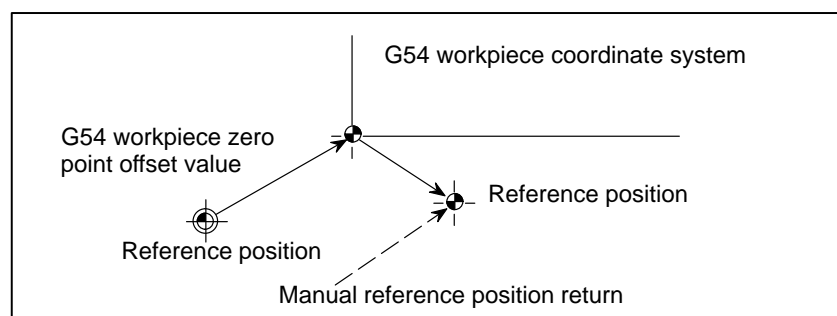
Format

G92.1 IP 0 ;

IP 0 ; Specifies axis addresses subject to the workpiece coordinate system preset operation. Axes that are not specified are not subject to the preset operation.

Explanations

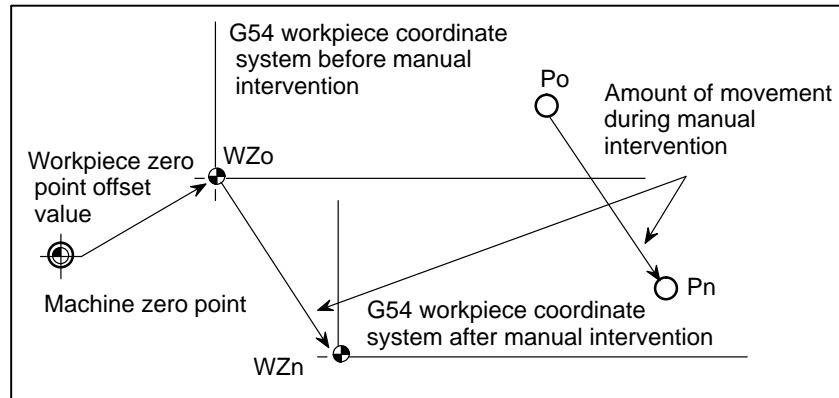
When manual reference position return operation is performed in the reset state, a workpiece coordinate system is shifted by the workpiece zero point offset value from the machine coordinate system zero point. Suppose that the manual reference position return operation is performed when a workpiece coordinate system is selected with G54. In this case, a workpiece coordinate system is automatically set which has its zero point displaced from the machine zero point by the G54 workpiece zero point offset value; the distance from the zero point of the workpiece coordinate system to the reference position represents the current position in the workpiece coordinate system.



If an absolute position detector is provided, the workpiece coordinate system automatically set at power-up has its zero point displaced from the machine zero point by the G54 workpiece zero point offset value. The machine position at the time of power-up is read from the absolute position detector and the current position in the workpiece coordinate system is set by subtracting the G54 workpiece zero point offset value from this machine position. The workpiece coordinate system set by these operations is shifted from the machine coordinate system using the commands and operations listed next page.

- (a) Manual intervention performed when the manual absolute signal is off
- (b) Move command executed in the machine lock state
- (c) Movement by handle interrupt
- (d) Operation using the mirror image function
- (e) Setting the local coordinate system using G52, or shifting the workpiece coordinate system using G92

In the case of (a) above, the workpiece coordinate system is shifted by the amount of movement during manual intervention.



In the operation above, a workpiece coordinate system once shifted can be preset using G code specification or MDI operation to a workpiece coordinate system displaced by a workpiece zero point offset value from the machine zero point. This is the same as when manual reference position return operation is performed on a workpiece coordinate system that has been shifted. In this example, such G code specification or MDI operation has the effect of returning workpiece coordinate system zero point WZn to the original zero point WZo, and the distance from WZo to Pn is used to represent the current position in the workpiece coordinate system.

Bit 3 (PPD) of parameter No. 3104 specifies whether to preset relative coordinates (RELATIVE) as well as absolute coordinates.

When no workpiece coordinate system option (G54 to G59) is selected, the workpiece coordinate system is preset to the coordinate system set by automatic workpiece coordinate system setting. When automatic workpiece coordinate system setting is not selected, the workpiece coordinate system is preset with its zero point placed at the reference position.

Limitations

- **Cutter compensation, tool length compensation, tool offset**
- **Program restart**
- **Prohibited modes**

When using the workpiece coordinate system preset function, cancel compensation modes: cutter compensation, tool length compensation, and tool offset. If the function is executed without cancelling these modes, compensation vectors are temporarily cancelled.

The workpiece coordinate system preset function is not executed during program restart.

Do not use the workpiece coordinate system preset function when the scaling, coordinate system rotation, programmable image, or drawing copy mode is set.

7.2.5 Adding Workpiece Coordinate Systems (G54.1 or G54)

Besides the six workpiece coordinate systems (standard workpiece coordinate systems) selectable with G54 to G59, 48 additional workpiece coordinate systems (additional workpiece coordinate systems) can be used. Alternatively, up to 300 additional workpiece coordinate systems can be used.

Format

- **Selecting the additional workpiece coordinate systems**

G54.1Pn ; or G54Pn ;

Pn : Codes specifying the additional workpiece coordinate systems
n : 1 to 48

- **Setting the workpiece zero point offset value in the additional workpiece coordinate systems**

G10L20 Pn IP_;

Pn : Codes specifying the workpiece coordinate system for setting the workpiece zero point offset value
n : 1 to 48
IP_ : Axis addresses and a value set as the workpiece zero point offset

Explanations

- **Selecting the additional workpiece coordinate systems**

When a P code is specified together with G54.1 (G54), the corresponding coordinate system is selected from the additional workpiece coordinate systems (1 to 48).

A workpiece coordinate system, once selected, is valid until another workpiece coordinate system is selected. Standard workpiece coordinate system 1 (selectable with G54) is selected at power-on.

```
G54.1 P1 . . . . Additional workpiece coordinate system 1
G54.1 P2 . . . . Additional workpiece coordinate system 2
      ⋮
G54.1 P48 . . . . Additional workpiece coordinate system 48
```

- **Setting the workpiece zero point offset value in the additional workpiece coordinate systems**

When an absolute workpiece zero point offset value is specified, the specified value becomes a new offset value. When an incremental workpiece zero point offset value is specified, the specified value is added to the current offset value to produce a new offset value.

As with the standard workpiece coordinate systems, the following operations can be performed for a workpiece zero point offset in an additional workpiece coordinate system:

- (1) The OFFSET function key can be used to display and set a workpiece zero point offset value.
- (2) The G10 function enables a workpiece zero point offset value to be set by programming (refer to II-7.2.3).

- (3) A custom macro allows a workpiece zero point offset value to be handled as a system variable.
- (4) Workpiece zero point offset data can be entered or output as external data.
- (5) The PMC window function enables workpiece zero point offset data to be read as program command modal data.

Limitations

- **Specifying P codes**

A P code must be specified after G54.1 (G54). If G54.1 is not followed by a P code in the same block, additional workpiece coordinate system 1 (G54.1P1) is assumed.

If a value not within the specifiable range is specified in a P code, an P/S alarm (No. 030) is issued.

P codes other than workpiece offset numbers cannot be specified in a G54.1 (G54) block.

Example) G54.1 (G54) G04 P1000 ;

7.3 LOCAL COORDINATE SYSTEM

When a program is created in a workpiece coordinate system, a child workpiece coordinate system can be set for easier programming. Such a child coordinate system is referred to as a local coordinate system.

Format

G52 IP_ ; Setting the local coordinate system

.....

G52 IP0 ; Canceling of the local coordinate system

IP_ : Origin of the local coordinate system

Explanations

By specifying G52 IP_;, a local coordinate system can be set in all the workpiece coordinate systems (G54 to G59). The origin of each local coordinate system is set at the position specified by IP_ in the workpiece coordinate system.

When a local coordinate system is set, the move commands in absolute mode (G90), which is subsequently commanded, are the coordinate values in the local coordinate system. The local coordinate system can be changed by specifying the G52 command with the zero point of a new local coordinate system in the workpiece coordinate system.

To cancel the local coordinate system and specify the coordinate value in the workpiece coordinate system, match the zero point of the local coordinate system with that of the workpiece coordinate system.

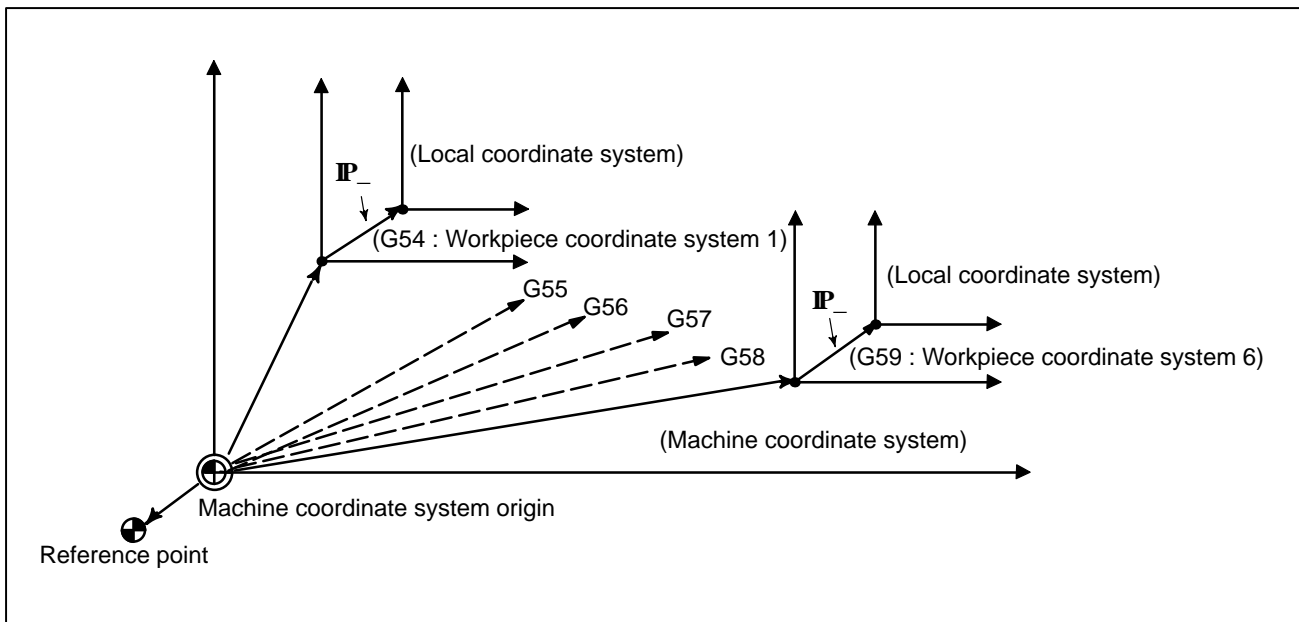


Fig. 7.3 Setting the local coordinate system

WARNING

- 1 When an axis returns to the reference point by the manual reference point return function, the zero point of the local coordinate system of the axis matches that of the work coordinate system. The same is true when the following command is issued:
G52 α 0;
 α :Axis which returns to the reference point
- 2 The local coordinate system setting does not change the workpiece and machine coordinate systems.
- 3 Whether the local coordinate system is canceled at reset depends on the parameter setting. The local coordinate system is canceled when either CLR, bit 6 of parameter No.3402 or RLC, bit 3 of parameter No.1202 is set to 1.
- 4 If coordinate values are not specified for all axes when setting a workpiece coordinate system with the G92 command, the local coordinate systems of axes for which coordinate values were not specified are not cancelled, but remain unchanged.
- 5 G52 cancels the offset temporarily in cutter compensation.
- 6 Command a move command immediately after the G52 block in the absolute mode.

7.4 PLANE SELECTION

Select the planes for circular interpolation, cutter compensation, and drilling by G-code.

The following table lists G-codes and the planes selected by them.

Explanations

Table 7.4 Plane selected by G code

G code	Selected plane	Xp	Yp	Zp
G17	Xp Yp plane	X-axis or an axis parallel to it	Y-axis or an axis parallel to it	Z-axis or an axis parallel to it
G18	Zp Xp plane			
G19	Yp Zp plane			

Xp, Yp, Zp are determined by the axis address appeared in the block in which G17, G18 or G19 is commanded.

When an axis address is omitted in G17, G18 or G19 block, it is assumed that the addresses of basic three axes are omitted.

Parameter No. 1022 is used to specify that an optional axis be parallel to the each axis of the X, Y-, and Z-axes as the basic three axes.

The plane is unchanged in the block in which G17, G18 or G19 is not commanded.

When the power is turned on or the CNC is reset, G17 (XY plane), G18 (ZX plane), or G19 (YZ plane) is selected by bits 1 (G18) and 2 (G19) of parameter 3402.

The movement instruction is irrelevant to the plane selection.

Examples

Plane selection when the X-axis is parallel with the U-axis.

G17X_Y_ XY plane,

G17U_Y_ UY plane

G18X_Z_ ZX plane

X_Y_ Plane is unchanged (ZX plane)

G17 XY plane

G18 ZX plane

G17 U_ UY plane

G18Y_ ; ZX plane, Y axis moves regardless without any relation to the plane.

8

COORDINATE VALUE AND DIMENSION

This chapter contains the following topics.

8.1 ABSOLUTE AND INCREMENTAL PROGRAMMING (G90, G91)

8.2 POLAR COORDINATE COMMAND (G15, G16)

8.3 INCH/METRIC CONVERSION (G20, G21)

8.4 DECIMAL POINT PROGRAMMING

8.1 ABSOLUTE AND INCREMENTAL PROGRAMMING (G90, G91)

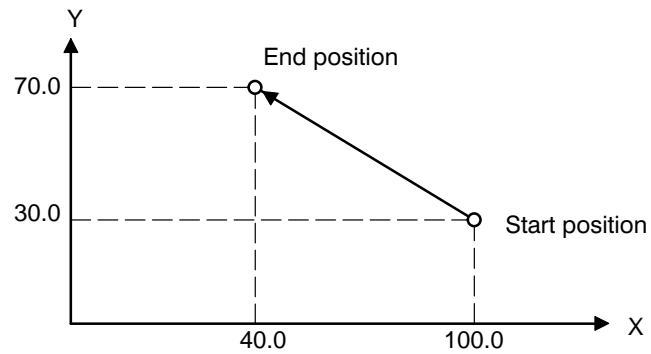
There are two ways to command travels of the tool; the absolute command, and the incremental command. In the absolute command, coordinate value of the end position is programmed; in the incremental command, move distance of the position itself is programmed. G90 and G91 are used to command absolute or incremental command, respectively.

Format

Absolute command	G90 IP_ ;
Incremental command	G91 IP_ ;

Examples

G90 X40.0 Y70.0 ;	Absolute command
G91 X-60.0 Y40.0 ;	Incremental command



8.2 POLAR COORDINATE COMMAND (G15, G16)

The end point coordinate value can be input in polar coordinates (radius and angle).

The plus direction of the angle is counterclockwise of the selected plane first axis + direction, and the minus direction is clockwise.

Both radius and angle can be commanded in either absolute or incremental command (G90, G91).

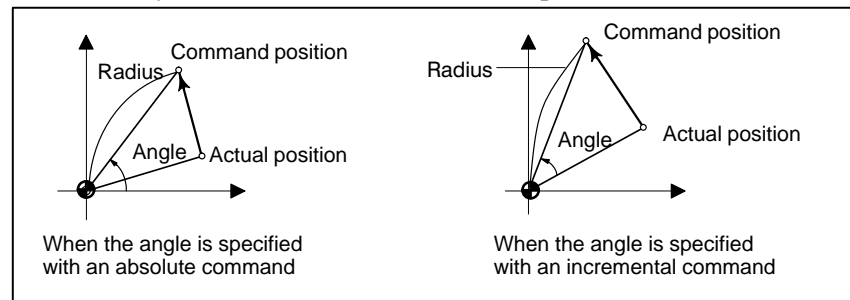
Format

G□□ G○○ G16 ;	Starting the polar coordinate command (polar coordinate mode)
G○○ IP _ ; ⋮	Polar coordinate command
G15 ;	
G16	Polar coordinate command
G15	Polar coordinate command cancel
G□□	Plane selection of the polar coordinate command (G17, G18 or G19)
G○○	G90 specifies the zero point of the work coordinate system as the origin of the polar coordinate system, from which a radius is measured. G91 specifies the current position as the origin of the polar coordinate system, from which a radius is measured.
IP _	Specifying the addresses of axes constituting the plane selected for the polar coordinate system, and their values First axis : radius of polar coordinate Second axis : radius of polar coordinate

- **Setting the zero point of the workpiece coordinate system as the origin of the polar coordinate system**

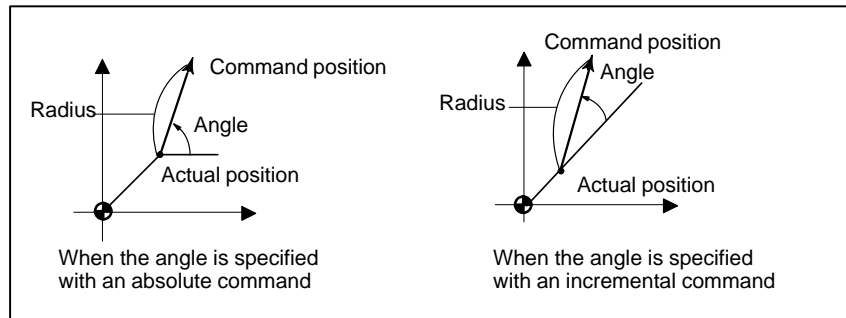
Specify the radius (the distance between the zero point and the point) to be programmed with an absolute command. The zero point of the work coordinate system is set as the origin of the polar coordinate system.

When a local coordinate system (G52) is used, the origin of the local coordinate system becomes the center of the polar coordinates.



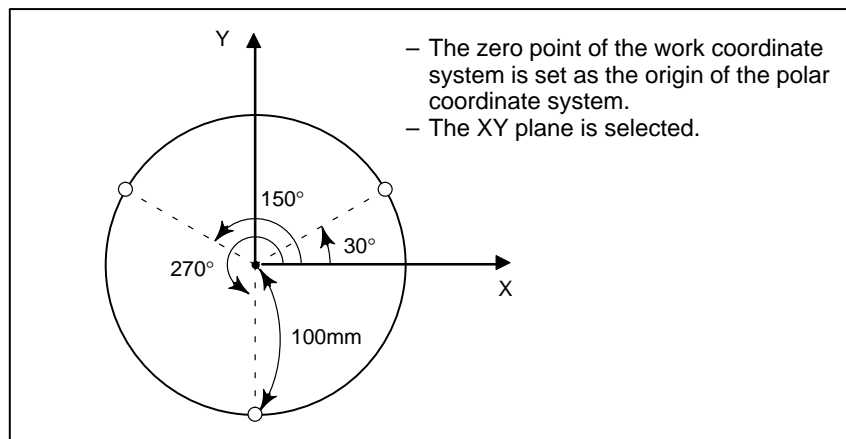
- **Setting the current position as the origin of the polar coordinate system**

Specify the radius (the distance between the current position and the point) to be programmed with an incremental command. The current position is set as the origin of the polar coordinate system.



Examples

Bolt hole circle



- **Specifying angles and a radius with absolute commands**

N1 G17 G90 G16 ;

Specifying the polar coordinate command and selecting the XY plane
Setting the zero point of the work coordinate system as the origin of the polar coordinate system

N2 G81 X100.0 Y30.0 Z-20.0 R-5.0 F200.0 ;

Specifying a distance of 100 mm and an angle of 30 degrees

N3 Y150.0 ;

Specifying a distance of 100 mm and an angle of 150 degrees

N4 Y270.0 ;

Specifying a distance of 100 mm and an angle of 270 degrees

N5 G15 G80 ;

Canceling the polar coordinate command

- **Specifying angles with incremental commands and a radius with absolute commands**

N1 G17 G90 G16;

Specifying the polar coordinate command and selecting the XY plane
Setting the zero point of the work coordinate system as the origin of the polar coordinate system

N2 G81 X100.0 Y30.0 Z-20.0 R-5.0 F200.0 ;

Specifying a distance of 100 mm and an angle of 30 degrees

N3 G91 Y120.0 ;

Specifying a distance of 100 mm and an angle of +120 degrees

N4 Y120.0 ;

Specifying a distance of 100 mm and an angle of +120 degrees

N5 G15 G80 ;

Canceling the polar coordinate command

Limitations

- **Specifying a radius in the polar coordinate mode**

In the polar coordinate mode, specify a radius for circular interpolation or helical cutting (G02, G03) with R.

- **Axes that are not considered part of a polar coordinate command in the polar coordinate mode**

Axes specified for the following commands are not considered part of the polar coordinate command:

- Dwell (G04)
- Programmable data input (G10)
- Setting the local coordinate system (G52)
- Converting the workpiece coordinate system (G92)
- Selecting the machine coordinate system (G53)
- Stored stroke check (G22)
- Coordinate system rotation (G68)
- Scaling (G51)

8.3 INCH/METRIC CONVERSION (G20,G21)

Either inch or metric input can be selected by G code.

Format

G20 ; Inch input

G21 ; mm input

This G code must be specified in an independent block before setting the coordinate system at the beginning of the program. After the G code for inch/metric conversion is specified, the unit of input data is switched to the least inch or metric input increment of increment system IS-B or IS-C (II- 2.3). The unit of data input for degrees remains unchanged. The unit systems for the following values are changed after inch/metric conversion:

- Feedrate commanded by F code
- Positional command
- Work zero point offset value
- Tool compensation value
- Unit of scale for manual pulse generator
- Movement distance in incremental feed
- Some parameters

When the power is turned on, the G code is the same as that held before the power was turned off.

WARNING

- 1 G20 and G21 must not be switched during a program.
- 2 When switching inch input (G20) to metric input (G21) and vice versa, the tool compensation value must be re-set according to the least input increment.
However, when bit 0 (OIM) of parameter 5006 is 1, tool compensation values are automatically converted and need not be re-set.

CAUTION

For the first G28 command after switching inch input to metric input or vice versa, operation from the intermediate point is the same as that for manual reference position return. The tool moves from the intermediate point in the direction for reference position return, specified with bit 5 (ZMI) of parameter No. 1006.

NOTE

- 1 When the least input increment and the least command increment systems are different, the maximum error is half of the least command increment. This error is not accumulated.
- 2 The inch and metric input can also be switched using settings.

8.4 DECIMAL POINT PROGRAMMING

Numerical values can be entered with a decimal point. A decimal point can be used when entering a distance, time, or speed. Decimal points can be specified with the following addresses:

X, Y, Z, U, V, W, A, B, C, I, J, K, Q, R, and F.

Explanations

There are two types of decimal point notation: calculator-type notation and standard notation.

When calculator-type decimal notation is used, a value without decimal point is considered to be specified in millimeters inch, or deg. When standard decimal notation is used, such a value is considered to be specified in least input increments. Select either calculator-type or standard decimal notation by using the DPI bit (bit 0 of parameter 3401). Values can be specified both with and without decimal point in a single program.

Examples

Program command	Pocket calculator type decimal point programming	Standard type decimal point programming
X1000 Command value without decimal point	1000mm Unit : mm	1mm Unit : Least input increment (0.001 mm)
X1000.0 Command value with decimal point	1000mm Unit : mm	1000mm Unit : mm

WARNING

In a single block, specify a G code before entering a value. The position of decimal point may depend on the command.

Examples:

G20; Input in inches

X1.0 G04; X1.0 is considered to be a distance and processed as X10000. This command is equivalent to G04 X10000. The tool dwells for 10 seconds.

G04 X1.0; Equivalent to G04 X1000. The tool dwells for one second.

NOTE

- 1 Fractions less than the least input increment are truncated.

Examples:

X1.23456; Truncated to X1.234 when the least input increment is 0.001 mm.
Processed as X1.2345 when the least input increment is 0.0001 inch.

- 2 When more than eight digits are specified, an alarm occurs. If a value is entered with a decimal point, the number of digits is also checked after the value is converted to an integer according to the least input increment.

Examples:

X1.23456789; P/S alarm 0.003 occurs because more than eight digits are specified.

X123456.7; If the least input increment is 0.001 mm, the value is converted to integer 123456700. Because the integer has more than eight digits, an alarm occurs.

9

SPINDLE SPEED FUNCTION (S FUNCTION)

The spindle speed can be controlled by specifying a value following address S.

This chapter contains the following topics.

9.1 SPECIFYING THE SPINDLE SPEED WITH A CODE

9.2 SPECIFYING THE SPINDLE SPEED VALUE DIRECTLY (S5-DIGIT COMMAND)

9.3 CONSTANT SURFACE SPEED CONTROL (G96, G97)

9.4 SPINDLE SPEED FLUCTUATION DETECTION FUNCTION (G25, G26)

9.1 SPECIFYING THE SPINDLE SPEED WITH A CODE

When a value is specified after address S, the code signal and strobe signal are sent to the machine to control the spindle rotation speed.

A block can contain only one S code. Refer to the appropriate manual provided by the machine tool builder for details such as the number of digits in an S code or the execution order when a move command and an S code command are in the same block.

9.2 SPECIFYING THE SPINDLE SPEED VALUE DIRECTLY (S5-DIGIT COMMAND)

The spindle speed can be specified directly by address S followed by a max.five-digit value (rpm). The unit for specifying the spindle speed may vary depending on the machine tool builder. Refer to the appropriate manual provided by the machine tool builder for details.

9.3 CONSTANT SURFACE SPEED CONTROL (G96, G97)

Specify the surface speed (relative speed between the tool and workpiece) following S. The spindle is rotated so that the surface speed is constant regardless of the position of the tool.

Format

- Constant surface speed control command

G96 S○○○○○○○ ;

↑ Surface speed (m/min or feet/min)

Note : This surface speed unit may change according to machine tool builder's specification.

- Constant surface speed control cancel command

G97 S○○○○○○○ ;

↑ Spindle speed (rpm)

Note : This surface speed unit may change according to machine tool builder's specification.

- Constant surface speed controlled axis command

G96 P α ; P0 : Axis set in the parameter (No. 3770)
P1 : X axis, P2 : Y axis, P3 : Z axis, P4 : 4th axis
P5 : 5th axis, P6 : 6th axis, P7 : 7th axis, P8 : 8th axis

- Clamp of maximum spindle speed

G92 S_— ; The maximum spindle speed (rpm) follows S.

Explanations

- **Constant surface speed control command (G96)**

G96 (constant surface speed control command) is a modal G code. After a G96 command is specified, the program enters the constant surface speed control mode (G96 mode) and specified S values are assumed as a surface speed. A G96 command must specify the axis along which constant surface speed control is applied. A G97 command cancels the G96 mode. When constant surface speed control is applied, a spindle speed higher than the value specified in G92S_; (maximum spindle speed) is clamped at the maximum spindle speed. When the power is turned on, the maximum spindle speed is not yet set and the speed is not clamped. S (surface speed) commands in the G96 mode are assumed as S = 0 (the surface speed is 0) until M03 (rotating the spindle in the positive direction) or M04 (rotating the spindle in the negative direction) appears in the program.

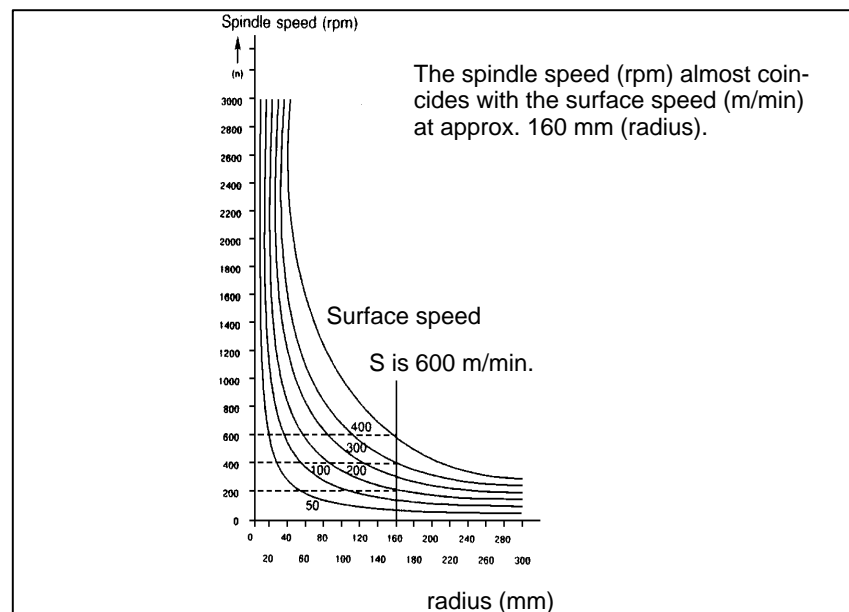


Fig. 9.3 (a) Relation between workpiece radius, spindle speed and surface speed

- **Setting the workpiece coordinate system for constant surface speed control**

To execute the constant surface speed control, it is necessary to set the work coordinate system, and so the coordinate value at the center of the rotary axis, for example, Z axis, (axis to which the constant surface speed control applies) becomes zero.

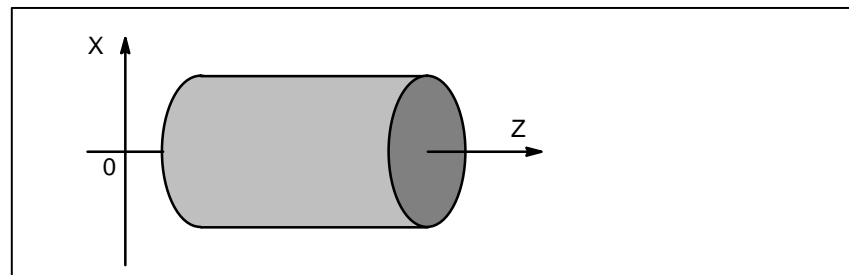
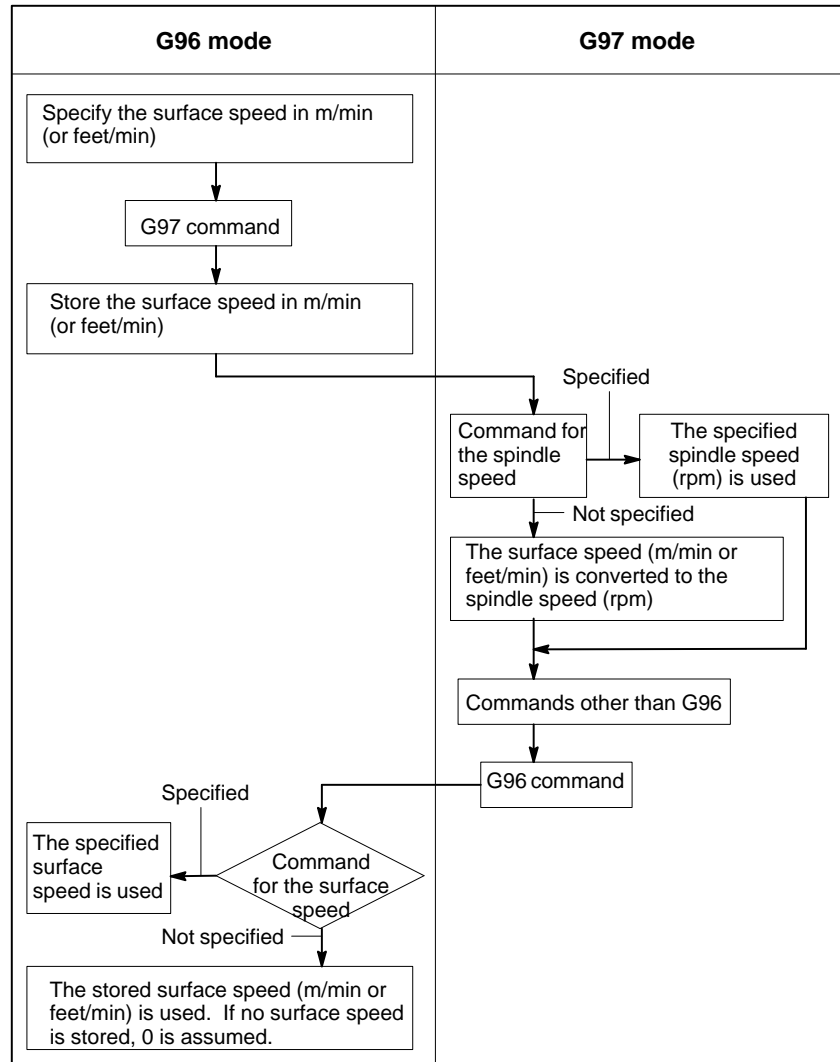


Fig. 9.3 (b) Example of the workpiece coordinate system for constant surface speed control

● **Surface speed specified in the G96 mode**



Restrictions

- **Constant surface speed control for threading**
- **Constant surface speed control for rapid traverse (G00)**

The constant surface speed control is also effective during threading. Accordingly, it is recommended that the constant surface speed control be invalidated with G97 command before starting the scroll threading and taper threading, because the response problem in the servo system may not be considered when the spindle speed changes.

In a rapid traverse block specified by G00, the constant surface speed control is not made by calculating the surface speed to a transient change of the tool position, but is made by calculating the surface speed based on the position at the end point of the rapid traverse block, on the condition that cutting is not executed at rapid traverse.

9.4 SPINDLE SPEED FLUCTUATION DETECTION FUNCTION (G25, G26)

With this function, an overheat alarm (No. 704) is raised when the spindle speed deviates from the specified speed due to machine conditions. This function is useful, for example, for preventing the seizure of the guide bushing.

Format

G26 enables spindle speed fluctuation detection.
G25 disables spindle speed fluctuation detection.

G26 Pp Qq Rr ; Spindle fluctuation detection on
G25 ; Spindle fluctuation detection off

p : Time (in ms) from the issue of a new spindle rotation command (S command) to the start of checking whether the actual spindle speed is so fast that an overheat can occur.

When a specified speed is reached within the time period of P, a check is started at that time.

q : Tolerance (%) of a specified spindle speed

$$q = \frac{1 - \text{actual spindle speed}}{\text{specified spindle speed}} \times 100$$

If a specified spindle speed lies within this range, it is regarded as having reached the specified value. Then, the checking of an actual spindle speed is started.

r : Spindle speed fluctuation (%) at which the actual spindle speed is so fast that an overheat can occur

$$r = \frac{1 - \text{speed that can cause overheat}}{\text{specified spindle speed}} \times 100$$

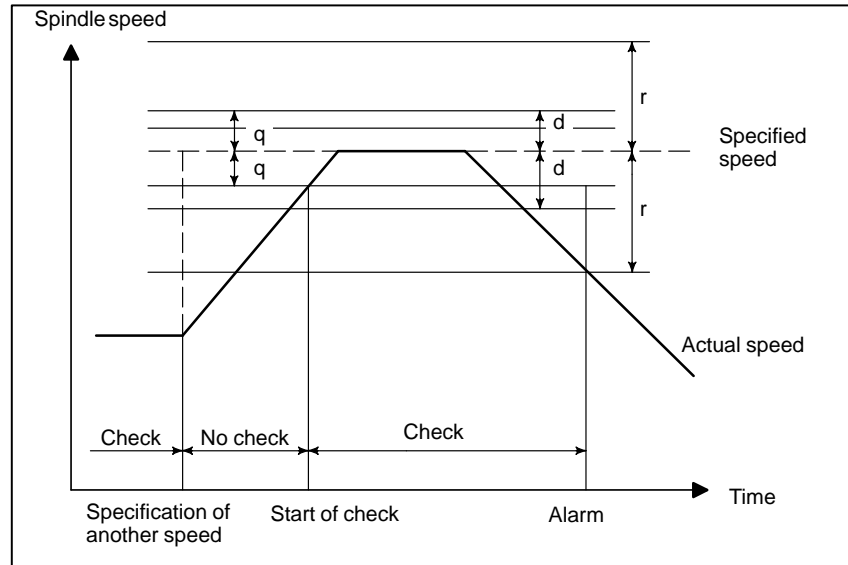
G26 enables the spindle speed fluctuation detection function, and G25 disables the spindle speed fluctuation detection.

Even if G25 is specified, p, q, and r are not cleared.

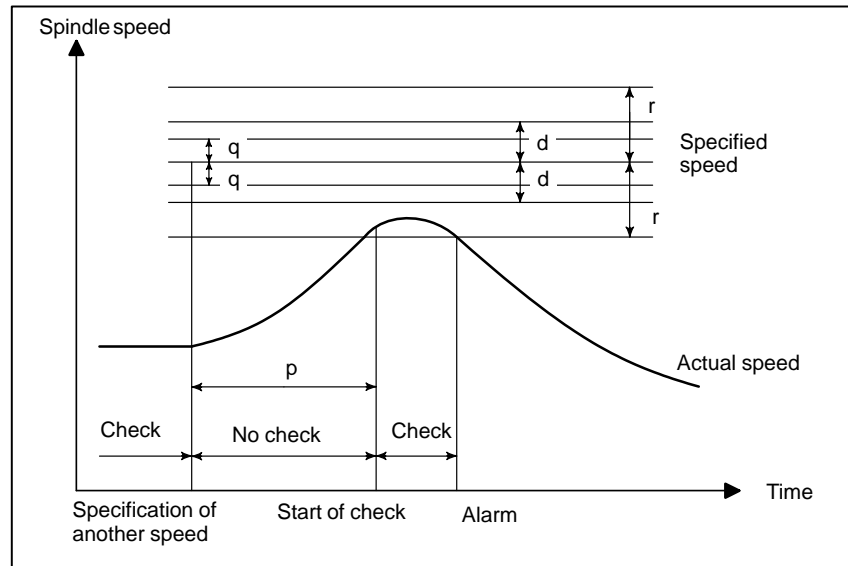
Explanations

The fluctuation of the spindle speed is detected as follows:

1. When an alarm is issued after a specified spindle speed is reached



2. When an alarm is issued before a specified spindle speed is reached



Specified speed :

(Speed specified by address S and five-digit value) × (spindle override)

Actual speed : Speed detected with a position coder

p : Time elapses since the specified speed changes until a check starts.

q : (Percentage tolerance for a check to start) × (specified speed)

r : (Percentage fluctuation detected as an alarm condition) × (specified speed)


d : Fluctuation detected as an alarm (specified in parameter (No.4913))

An alarm is issued when the difference between the specified speed and the actual speed exceeds both r and d.

NOTE

- 1 When an alarm is issued in automatic operation, a single block stop occurs. The spindle overheat alarm is indicated on the screen, and the alarm signal "SPAL" is output (set to 1 for the presence of an alarm). This signal is cleared by resetting.
- 2 Even when reset operation is performed after an alarm occurs, the alarm is issued again unless the cause of the alarm is corrected.
- 3 No check is made during spindle stop state (*SSTP = 0).
- 4 By setting the parameter (No. 4913), an allowable range of speed fluctuations can be set which suppresses the occurrence of an alarm. However, an alarm is issued one second later if the actual speed is found to be 0 rpm.

10 TOOL FUNCTION (T FUNCTION)



General

Two tool functions are available. One is the tool selection function, and the other is the tool life management function.

10.1 TOOL SELECTION FUNCTION

By specifying an up to 8–digit numerical value following address T, tools can be selected on the machine.

One T code can be commanded in a block. Refer to the machine tool builder's manual for the number of digits commandable with address T and the correspondence between the T codes and machine operations.

When a move command and a T code are specified in the same block, the commands are executed in one of the following two ways:

- (i) Simultaneous execution of the move command and T function commands.
- (ii) Executing T function commands upon completion of move command execution.

The selection of either (i) or (ii) depends on the machine tool builder's specifications. Refer to the manual issued by the machine tool builder for details.

10.2 TOOL LIFE MANAGEMENT FUNCTION

Tools are classified into various groups, with the tool life (time or frequency of use) for each group being specified. The function of accumulating the tool life of each group in use and selecting and using the next tool previously sequenced in the same group, is called the tool life management function.

Tool group number m				
1	Tool number	Code specifying tool compensation value	Tool life	The first tool life management data
⋮				
n				The nth tool life management data

Fig.10.2(a) Tool life management data (number of n tools)

By choosing a tool from a tool group specified by a machining program, the tool life can be managed.

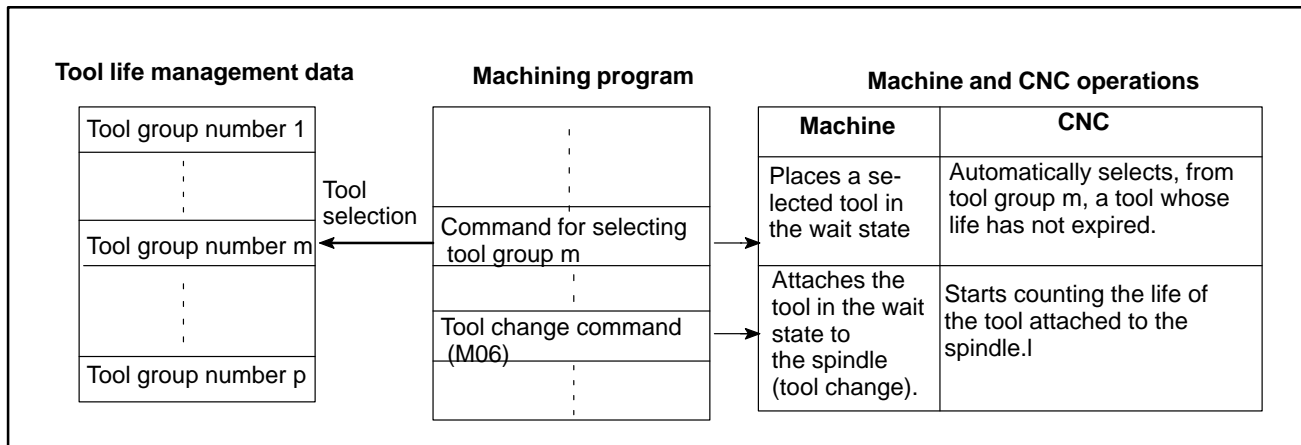


Fig. 10.2(b) Tool Selection by Machining Program

For two-path control, tool life management is applied independently for each path. Tool life management data is also set for each path.

10.2.1 Tool Life Management Data

Tool life management data consists of tool group numbers, tool numbers, codes specifying tool compensation values, and tool life value.

Explanations

- **Tool group number** The Max. number of groups and the number of tools per group that can be registered are set by parameter (GS1,GS2 No. 6800#0, #1) (Table 10.2.1 (a)).

Table 10.2.1 (a) The Max. number of groups and tools that can be registered

GS1 (No. 6800#0)	GS2 (No. 6800#1)	The Max. number of groups and tools without optional function of 512 tool pairs		The Max. number of groups and tools with optional function of 512 tool pairs	
		Number of group	Number of tool	Number of group	Number of tool
0	0	16	16	64	32
0	1	32	8	128	16
1	0	64	4	256	8
1	1	128	2	512	4

WARNING

When bits 0 or 1 of parameter GS1,GS2 No.6800 is changed, re-register tool life management data with the G10L3 command (for registering and deleting data for all groups). Otherwise, new data pairs cannot be set.

- **Tool number** Specify a four-digit number after T.
- **Code specifying tool compensation value** Codes specifying tool offset values are classified into H codes (for tool length offset) and D codes (cutter compensation). The maximum number of the tool compensation value specification code which can be registered is 255 when there are 400 tool compensation values (even if the option for 512 tool life management sets is supported). The maximum number is 32, 64, 99, 200, 499, or 999 when there are 32, 64, 99, 200, 499, or 999 tool compensation values.

NOTE

When codes specifying tool offset values are not used, registration can be omitted.

- **Tool life value** Refer to II- 10.2.2 and II-10.2.4.

10.2.2 Register, Change and Delete of Tool Life Management Data

In a program, tool life management data can be registered in the CNC unit, and registered tool life management data can be changed or deleted.

Explanations

A different program format is used for each of the four types of operations described below.

- **Register with deleting all groups**
After all registered tool life management data is deleted, programmed tool life management data is registered.
- **Addition and change of tool life management data**
Programmed tool life management data for a group can be added or changed.
- **Deletion of tool life management data**
Programmed tool life management data for a group can be deleted.
- **Register of tool life count type**
Count types (time or frequency) can be registered for individual groups.
- **Life value**
Whether tool life is to be indicated by time (minutes) or by frequency, it is set by a parameter LTM (No. 6800 #2) .
Maximum value of tool life is as follows.
In case of minute:4300(minutes)
In case of frequency :9999(times)

Format

- Register with deleting all groups

Format	Meaning of command
G10L3 ; P-L ; T-H-D ; T-H-D ; . . . P-L ; T-H-D ; T-H-D ; . . . G11 ; M02 (M30) ;	G10L3 :Register with deleting all groups P- :Group number L- :Life value T- :Tool number H- :Code specifying tool offset value (H code) D- :Code specifying tool offset value (D code) G11 :End of registration

- Addition and change of tool life management data

Format	Meaning of command
G10L3P1 ; P-L ; T-H-D ; T-H-D ; . . . P-L ; T-H-D ; T-H-D ; . . . G11 ; M02 (M30) ;	G10L3P1 :Addition and change of group P- :Group number L- :Life value T- :Tool number H- :Code specifying tool offset value (H code) D- :Code specifying tool offset value (D code) G11 :End of addition and change of group

- Deletion of tool life management data

Format	Meaning of command
G10L3P2 ; P- ; P- ; P- ; P- ; . . . G11 ; M02 (M30) ;	G10L3P2 :Deletion of group P- :Group number G11 :End of deletion of group

● **Setting a tool life count type for groups**

Format	Meaning of command
<p>G10L3 or G10L3P1); P-L-Q ; T-H-D ; T-H-D ; P-L-Q ; T-H-D ; T-H-D ; G11 ; M02 (M30) ;</p>	<p>Q_ : Life count type (1:Frequency, 2:Time)</p>

CAUTION

When the Q command is omitted, the value set in bit 7 (LTM) of parameter No.6800 is used as the life count type.

10.2.3 Tool Life Management Command in a Machining Program

Explanations

- **Command**

The following command is used for tool life management:
T▽▽▽▽;—Specifies a tool group number.

The tool life management function selects, from a specified group, a tool whose life has not expired, and outputs its T code. In ▽▽▽▽, specify a number calculated by adding the tool life management cancel number specified in parameter6810 to a group number. For example, to set tool group 1 when the tool life management cancel number is 100, specify T101;.

NOTE

When ▽▽▽▽ is less than a tool life management cancel number, the T code is treated as an ordinary T code.

M06;——Terminates life management for the previously used tools, and begins counting the life of the new tools selected with the T code.

WARNING

When an option for specifying multiple M codes is selected, specify this code by itself or as the first M code.

H99;——Selects the H code of tool life management data for the tool currently being used.

H00;——Cancels tool length offset

D99;——Selects the D code of tool life management data for the tool currently being used.

D00;——Cancels cutter compensation

WARNING

H99 or D99 must be specified after the M06 command. When a code other than H99 or D99 is specified after the M06 command, the H code and D code of tool life management data are not selected.

- **Types**

For tool life management, the four tool change types indicated below are available. The type used varies from one machine to another. For details, refer to the appropriate manual of each machine tool builder.

Table 10.2.3 Tool Change Type

Tool change type	A	B	C	D
Tool group number specified in the same block as the tool change command (M06)	Previously used tools	Tools to be used next		
Tool life counting timing	Life counting is performed for a tool in the specified tool group when M06 is specified next.		Life counting is performed when a tool in the tool group specified in the same block as M06 is specified.	
Remarks		Normally, when a tool group number is specified by itself, type B is used. However, no alarm is raised even if the tool group number is specified by itself as type C.	When only M06 is specified, P/S alarm No. 153 is issued.	
Parameter	No. 6800#7 (M6T)=0 No.6801#7 (M6E)=0	No. 6800#7 (M6T)=1 No. 6801#7 (M6E)=0	No.6801#7 (M6E)=1	

NOTE

When a tool group number is specified and a new tool is selected, the new tool selection signal is output.

Examples

- **Tool change type A**

Suppose that the tool life management cancel number is 100.

```
T101;  A tool whose life has not expired is selected from group 1.
      |  (Suppose that tool number 010 is selected.)
      |
M06;   Tool life counting is performed for the tool in group 1.
      |  (The life of tool number 010 is counted.)
      |
T102;  A tool whose life has not expired is selected from group 2.
      |  (Suppose that tool number 100 is selected.)
      |
M06T101; Tool life counting is performed for the tool in group 2.
      |  (The life of tool number 100 is counted.)
      |  The number of the tool currently used (in group 1) is
      |  output with a T code signal. (Tool number 010 is
      |  output.)
```

- **Tool change type B and C**

Suppose that the tool life management ignore number is 100.

T101; A tool whose life has not expired is selected from group 1.
 : (Suppose that tool number 010 is selected.)
 M06T102; Tool life counting is performed for the tool in group 1.
 : (The life of tool number 010 is counted.)
 : A tool whose life has not expired is selected from group 2.
 : (Suppose that toolnumber 100 is selected.)
 M06T103; Tool life counting is lperformed for the tool in group 2.
 : (The life of tool number 100 is counted.)
 : A tool whose life has not expired is selected from group 3.
 : (Suppose that tool number 200 is selected.)

- **Tool change type D**

Suppose that the tool life management ignore number is 100.

T101M06; A tool whose life has not expired is selected from group 1.
 : (Suppose that tool number 010 is selected.)
 : Tool life counting is performed for the tool in group 1.
 :
 T102M06; A tool whose life has not expired is selected from group 2.
 : (Suppose that tool number 100 is selected.)
 : Tool life counting is performed for the tool in group 2.
 : (The life of tool number 100 is counted.)

10.2.4 Tool Life

The life of a tool is specified by a usage frequency (count) or usage time (in minutes).

Explanations

- Usage count

The usage count is incremented by 1 for each tool used in a program. In other words, the usage count is incremented by 1 only when the first tool group number and tool change command are specified after the CNC unit enters the automatic operation state from the reset state.

CAUTION

Even if the same tool group number is specified more than once in a program, the usage count is only incremented by 1 and no new tools are selected.

- Usage time

When a tool change is specified (M06), tool life management is started for the tools specified by the tool group number. In tool life management, the time during which a tool is used in the cutting mode is counted in four second increments. If the tool group is changed before the incremental time of four seconds elapses, the time is not counted. The time a tool is used for single block stop, feed hold, rapid traverse, dwell, machine lock, and interlock is not counted.

NOTE

- 1 When a tool is selected from available tools, tools are searched starting from the current tool towards the last tool to find a tool whose life has not expired. When the last tool is reached during this search, the search restarts from the first tool. When it has been determined that there are no tools whose life has not expired, the last tool is selected. When the tool currently being used is changed by tool skip signal, the next new tool is selected using the method described here.
- 2 When tool life is counted by time, the life counting can be overridden using the tool life count override signal. An override from 0 to 99.9 can be applied. When 0 is specified, time is not counted. Before the override capability can be used, bit 2 of parameter LFV No.6801 must be set.
- 3 When tool life counting indicates that the life of the last tool in a group has expired, the tool change signal is output. When tool life is managed by time, the signal is output when the life of the last tool in the group has expired. When tool life is managed by usage frequency (count), the signal is output when the CNC unit is reset or the tool life count restart M code is specified.

11

AUXILIARY FUNCTION

General

There are two types of auxiliary functions ; miscellaneous function (M code) for specifying spindle start, spindle stop program end, and so on, and secondary auxiliary function (B code) for specifying index table positioning.

When a move command and miscellaneous function are specified in the same block, the commands are executed in one of the following two ways:

- i) Simultaneous execution of the move command and miscellaneous function commands.
- ii) Executing miscellaneous function commands upon completion of move command execution.

The selection of either sequence depends on the machine tool builder's specification. Refer to the manual issued by the machine tool builder for details.

11.1 AUXILIARY FUNCTION (M FUNCTION)

When a numeral is specified following address M, code signal and a strobe signal are sent to the machine. The machine uses these signals to turn on or off its functions.

Usually, only one M code can be specified in one block. In some cases, however, up to three M codes can be specified for some types of machine tools.

Which M code corresponds to which machine function is determined by the machine tool builder.

The machine processes all operations specified by M codes except those specified by M98, M99, M198 or called subprogram (Parameter No. 6071 to 6079), or called custom macro (Parameter No. 6080 to 6089). Refer to the machine tool builder's instruction manual for details.

Explanations

- **M02, M03
(End of program)**

The following M codes have special meanings.

This indicates the end of the main program

Automatic operation is stopped and the CNC unit is reset.

This differs with the machine tool builder.

After a block specifying the end of the program is executed, control returns to the start of the program.

Bit 5 of parameter 3404 (M02) or bit 4 of parameter 3404 (M30) can be used to disable M02, M30 from returning control to the start of the program.

- **M00
(Program stop)**

Automatic operation is stopped after a block containing M00 is executed.

When the program is stopped, all existing modal information remains unchanged. The automatic operation can be restarted by actuating the cycle operation. This differs with the machine tool builder.

- **M01
(Optional stop)**

Similarly to M00, automatic operation is stopped after a block containing M01 is executed. This code is only effective when the Optional Stop switch on the machine operator's panel has been pressed.

- **M98
(Calling of sub-program)**

This code is used to call a subprogram. The code and strobe signals are not sent. See the subprogram **II- 12.3** for details .

- **M99
(End of subprogram)**

This code indicates the end of a subprogram.

M99 execution returns control to the main program. The code and strobe signals are not sent. See the subprogram **section 12.3** for details.

- **M198 (Calling a subprogram)**

This code is used to call a subprogram of a file in the external input/output function. See the description of the subprogram call function (III-4.7) for details.

NOTE

The block following M00, M01, M02, or M30 is not pre-read (buffered). Similarly, ten M codes which do not buffer can be set by parameters (Nos. 3411 to 3420). Refer to the machine tool builder's instruction manual for these M codes.

11.2 MULTIPLE M COMMANDS IN A SINGLE BLOCK

In general, only one M code can be specified in a block. However, up to three M codes can be specified at once in a block by setting bit 7 (M3B) of parameter No. 3404 to 1. Up to three M codes specified in a block are simultaneously output to the machine. This means that compared with the conventional method of a single M command in a single block, a shorter cycle time can be realized in machining.

Explanations

CNC allows up to three M codes to be specified in one block. However, some M codes cannot be specified at the same time due to mechanical operation restrictions. For detailed information about the mechanical operation restrictions on simultaneous specification of multiple M codes in one block, refer to the manual of each machine tool builder.

M00, M01, M02, M30, M98, M99, or M198 must not be specified together with another M code.

Some M codes other than M00, M01, M02, M30, M98, M99, and M198 cannot be specified together with other M codes; each of those M codes must be specified in a single block.

Such M codes include these which direct the CNC to perform internal operations in addition to sending the M codes themselves to the machine. To be specified, such M codes are M codes for calling program numbers 9001 to 9009 and M codes for disabling advance reading (buffering) of subsequent blocks. Meanwhile, multiple of M codes that direct the CNC only to send the M codes themselves (without performing internal operations) can be specified in a single block.

Examples

One M command in a single block	Multiple M commands in a single block
M40 ;	M40M50M60 ;
M50 ;	G28G91X0Y0Z0 ;
M60 ;	:
G28G91X0Y0Z0 ;	:
:	:
:	:
:	:

11.3 M CODE GROUP CHECK FUNCTION

The M code group check function checks if a combination of multiple M codes (up to three M codes) contained in a block is correct.

This function has two purposes. One is to detect if any of the multiple M codes specified in a block include an M code that must be specified alone. The other purpose is to detect if any of the multiple M codes specified in a block include M codes that belong to the same group. In either of these cases, P/S alarm No. 5016 is issued.

For details on group data setting, refer to the manual available from the machine tool builder.

Explanations

- **M code setting**

Up to 500 M codes can be specified. In general, M0 to M99 are always specified. M codes from M100 and up are optional.

- **Group numbers**

Group numbers can be set from 0 to 127. Note, however, that 0 and 1 have special meanings. Group number 0 represents M codes that need not be checked. Group number 1 represents M codes that must be specified alone.

11.4 THE SECOND AUXILIARY FUNCTIONS (B CODES)

Indexing of the table is performed by address B and a following 8-digit number. The relationship between B codes and the corresponding indexing differs between machine tool builders.

Refer to the manual issued by the machine tool builder for details.

Explanations

- **Valid data range**
- **Specification**

0 to 99999999

1. To enable the use of a decimal point, set bit 0 (AUP) of parameter No.3450 to 1.

Command	Output value
B10.	10000
B10	10

2. Use bit 0 (DPI) of parameter No. 3401 to specify whether the magnification for B output will be $\times 1000$ or $\times 1$ when a decimal point is omitted.

	Command	Output value
DPI=1	B1	1000
DPI=0	B1	1

3. Use bit 0 (AUX) of parameter No. 3405 to specify whether the magnification for B output will be $\times 1000$ or $\times 10000$ when a decimal point is omitted for the inch Input system (only when DPI=1).

	Command	Output value
AUX=1	B1	10000
AUX=0	B1	1000

Restrictions

When this functions is used, the B address specifying an axis movement disabled.

12 PROGRAM CONFIGURATION

General

- **Main program and subprogram**

There are two program types, main program and subprogram. Normally, the CNC operates according to the main program. However, when a command calling a subprogram is encountered in the main program, control is passed to the subprogram. When a command specifying a return to the main program is encountered in a subprogram, control is returned to the main program.

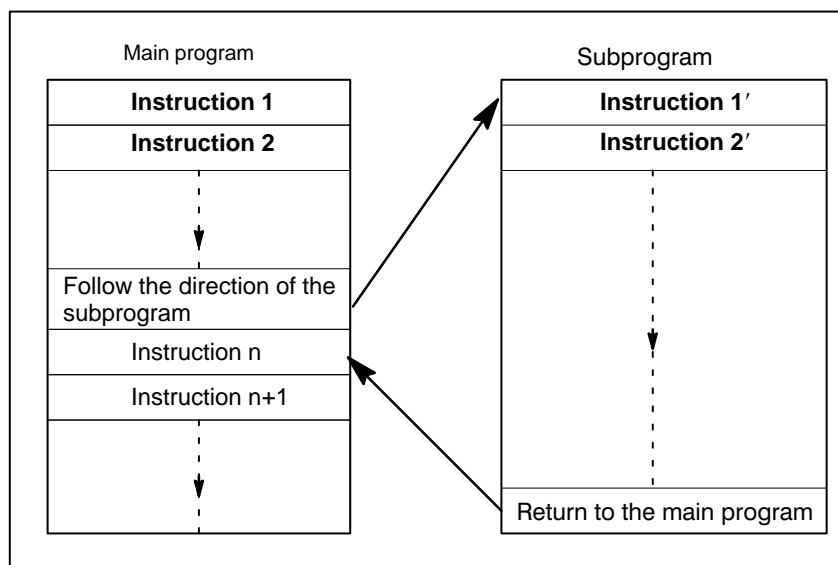


Fig. 12 (a) Main program and Subprogram

The CNC memory can hold up to 400 main programs and subprograms (63 as standard). A main program can be selected from the stored main programs to operate the machine. See III-9.3 or III-10 in OPERATION for the methods of registering and selecting programs.

● **Program components**

A program consists of the following components:

Table 12 Program components

Components	Descriptions
Tape start	Symbol indicating the start of a program file
Leader section	Used for the title of a program file, etc.
Program start	Symbol indicating the start of a program
Program section	Commands for machining
Comment section	Comments or directions for the operator
Tape end	Symbol indicating the end of a program file

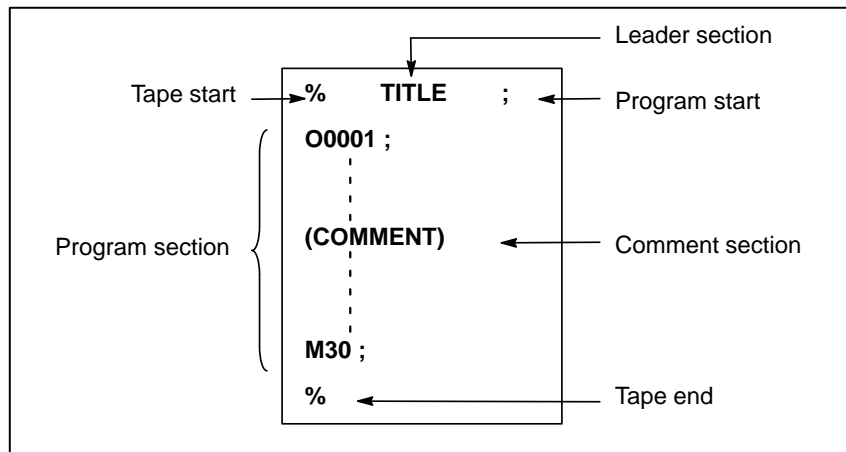


Fig. 12(b) Program configuration

● **Program section configuration**

A program section consists of several blocks. A program section starts with a program number and ends with a program end code.

<u>Program section configuration</u>	<u>Program section</u>
Program number	O0001 ;
Block 1	N1 G91 G00 X120.0 Y80.0 ;
Block 2	N2 G43 Z-32.0 H01 ;
:	:
Block n	Nn Z0 ;
Program end	M30 ;

A block contains information necessary for machining, such as a move command or coolant on/off command. Specifying a slash (/) at the start of a block disables the execution of some blocks (see “optional block skip” in II-12.2).

12.1 PROGRAM COMPONENTS OTHER THAN PROGRAM SECTIONS

This section describes program components other than program sections. See II-12.2 for a program section.

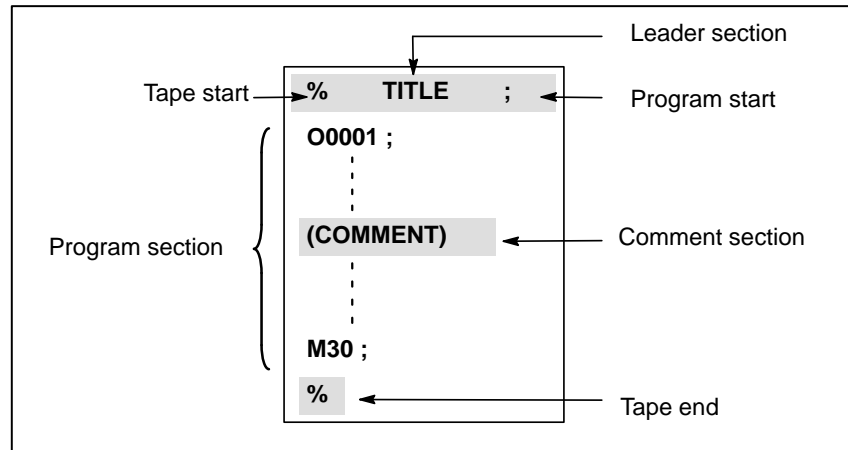


Fig. 12.1(a) Program configuration

Explanations

- **Tape start**

The tape start indicates the start of a file that contains NC programs. The mark is not required when programs are entered using SYSTEM P or ordinary personal computers. The mark is not displayed on the screen. However, if the file is output, the mark is automatically output at the start of the file.

Table 12.1(a) Code of a tape start

Name	ISO code	EIA code	Notation in this manual
Tape start	%	ER	%

- **Leader section**

Data entered before the programs in a file constitutes a leader section. When machining is started, the label skip state is usually set by turning on the power or resetting the system. In the label skip state, all information is ignored until the first end-of-block code is read. When a file is read into the CNC unit from an I/O device, leader sections are skipped by the label skip function.

A leader section generally contains information such as a file header. When a leader section is skipped, even a TV parity check is not made. So a leader section can contain any codes except the EOB code.

- **Program start**

The program start code is to be entered immediately after a leader section, that is, immediately before a program section.

This code indicates the start of a program, and is always required to disable the label skip function.

With SYSTEM P or ordinary personal computers, this code can be entered by pressing the return key.

Table 12.1(b) Code of a program start

Name	ISO code	EIA code	Notation in this manual
Program start	LF	CR	;

NOTE

If one file contains multiple programs, the EOB code for label skip operation must not appear before a second or subsequent program number.

- **Comment section**

Any information enclosed by the control-out and control-in codes is regarded as a comment.

The user can enter a header, comments, directions to the operator, etc. in a comment section.

Table 12.1(c) Codes of a control-in and a control-out

Name	ISO code	EIA code	Notation in this manual	Meaning
Control-out	(2-4-5	(Start of comment section
Control-in)	2-4-7)	End of comment section

When a program is read into memory for memory operation, comment sections, if any, are not ignored but are also read into memory. Note, however, that codes other than those listed in the code table in Appendix A are ignored, and thus are not read into memory.

When data in memory is output on external I/O device(See III-8), the comment sections are also output.

When a program is displayed on the screen, its comment sections are also displayed. However, those codes that were ignored when read into memory are not output or displayed.

During memory operation or DNC operation, all comment sections are ignored.

The TV check function can be used for a comment section by setting parameter CTV (bit 1 of No. 0100).

CAUTION

If a long comment section appears in the middle of a program section, a move along an axis may be suspended for a long time because of such a comment section. So a comment section should be placed where movement suspension may occur or no movement is involved.

NOTE

- 1 If only a control-in code is read with no matching control-out code, the read control-in code is ignored.
- 2 The EOB code cannot be used in a comment.

- **Tape end**

A tape end is to be placed at the end of a file containing NC programs. If programs are entered using the automatic programming system, the mark need not be entered.

The mark is not displayed on the screen. However, when a file is output, the mark is automatically output at the end of the file.

If an attempt is made to execute % when M02 or M03 is not placed at the end of the program, the P/S alarm (No. 5010) is occurred.

Table 12.1(d) Code of a tape end

Name	ISO code	EIA code	Notation in this manual
Tape end	%	ER	%

12.2 PROGRAM SECTION CONFIGURATION

This section describes elements of a program section. See II-12.1 for program components other than program sections.

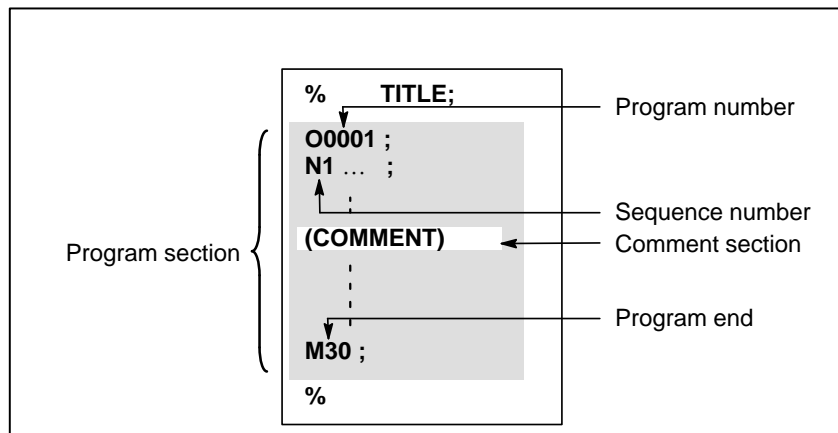


Fig. 12.2(a) Program configuration

- **Program number**

A program number consisting of address O followed by a four-digit number is assigned to each program at the beginning registered in memory to identify the program.

In ISO code, the colon (:) can be used instead of O.

When no program number is specified at the start of a program, the sequence number (N...) at the start of the program is regarded as its program number. If a five-digit sequence number is used, the lower four digits are registered as a program number. If the lower four digits are all 0, the program number registered immediately before added to 1 is registered as a program number. Note, however, that N0 cannot be used for a program number.

If there is no program number or sequence number at the start of a program, a program number must be specified using the MDI panel when the program is stored in memory (See III-8.4 or III-10.1)

NOTE

Program numbers 8000 to 9999 may be used by machine tool builders, and the user may not be able to use these numbers.

- **Sequence number and block**

A program consists of several commands. One command unit is called a block. One block is separated from another with an EOB of end of block code.

Table 12.2(a) EOB code

Name	ISO code	EIA code	Notation in this manual
End of block (EOB)	LF	CR	;

At the head of a block, a sequence number consisting of address N followed by a number not longer than five digits (1 to 99999) can be placed. Sequence numbers can be specified in a random order, and any numbers can be skipped. Sequence numbers may be specified for all blocks or only for desired blocks of the program. In general, however, it is convenient to assign sequence numbers in ascending order in phase with the machining steps (for example, when a new tool is used by tool replacement, and machining proceeds to a new surface with table indexing.)

N300 X200.0 Z300.0 ; A sequence number is underlined.

Fig. 12.2(b) Sequence number and block (example)

NOTE

N0 must not be used for the reason of file compatibility with other CNC systems.

Program number 0 cannot be used. So 0 must not be used for a sequence number regarded as a program number.

- **TV check (Vertical parity check along tape)**

A parity check is made for a block on input tape vertically. If the number of characters in one block (starting with the code immediately after an EOB and ending with the next EOB) is odd, an P/S alarm (No.002) is output. No TV check is made only for those parts that are skipped by the label skip function. Bit 1 (CTV) of parameter No. 0100 is used to specify whether comments enclosed in parentheses are counted as characters during TV check. The TV check function can be enabled or disabled by setting on the MDI unit (See III-11.4.3.).

- **Block configuration (word and address)**

A block consists of one or more words. A word consists of an address followed by a number some digits long. (The plus sign (+) or minus sign (-) may be prefixed to a number.)

Word = Address + number (Example : X-1000)

For an address, one of the letters (A to Z) is used ; an address defines the meaning of a number that follows the address. Table 12.2 (b) indicates the usable addresses and their meanings.

The same address may have different meanings, depending on the preparatory function specification.

Table 12.2(b) Major functions and addresses

Function	Address	Meaning
Program number	O ⁽¹⁾	Program number
Sequence number	N	Sequence number
Preparatory function	G	Specifies a motion mode (linear, arc, etc.)
Dimension word	X, Y, Z, U, V, W, A, B, C	Coordinate axis move command
	I, J, K	Coordinate of the arc center
	R	Arc radius
Feed function	F	Rate of feed per minute, Rate of feed per revolution
Spindle speed function	S	Spindle speed
Tool function	T	Tool number
Auxiliary function	M	On/off control on the machine tool
	B	Table indexing, etc.
Offset number	D, H	Offset number
Dwell	P, X	Dwell time
Program number designation	P	Subprogram number
Number of repetitions	P	Number of subprogram repetitions
Parameter	P, Q	Canned cycle parameter

NOTE

In ISO code, the colon (:) can also be used as the address of a program number.

N_	G_	X_ Y_	F_	S_	T_	M_ ;
Sequence number	Preparatory function	Dimension word	Feed-function	Spindle speed function	Tool function	Miscellaneous function

Fig. 12.2 (c) 1 block (example)

- **Major addresses and ranges of command values**

Major addresses and the ranges of values specified for the addresses are shown below. Note that these figures represent limits on the CNC side, which are totally different from limits on the machine tool side. For example, the CNC allows a tool to traverse up to about 100 m (in millimeter input) along the X axis.

However, an actual stroke along the X axis may be limited to 2 m for a specific machine tool.

Similarly, the CNC may be able to control a cutting federate of up to 240 m/min, but the machine tool may not allow more than 3 m/min. When developing a program, the user should carefully read the manuals of the machine tool as well as this manual to be familiar with the restrictions on programming.

Table 12.2(c) Major addresses and ranges of command values

Function		Address	Input in mm	Input in inch
Program number		O ⁽¹⁾	1-9999	1-9999
Sequence number		N	1-99999	1-99999
Preparatory function		G	0-99	0-99
Dimension word	Increment system IS-B	X, Y, Z, U, V, W, A, B, C, I, J, K, R,	±99999.999mm	±9999.9999inch
	Increment system IS-C		±9999.9999mm	±999.99999inch
Feed per minute	Increment system IS-B	F	1-240000mm/min	0.01-9600.00 inch/min
	Increment system IS-C		1-100000mm/min	0.01-4000.00 inch/min
Feed per revolution		F	0.001-500.00 mm/rev	0.0001-9.9999 inch/rev
Spindle speed function		S	0-20000	0-20000
Tool function		T	0-99999999	0-99999999
Auxiliary function		M	0-99999999	0-99999999
		B	0-99999999	0-99999999
Offset number		H, D	0-400	0-400
Dwell	Increment system IS-B	X, P	0-99999.999s	0-99999.999s
	Increment system IS-C		0-9999.9999s	0-9999.9999s
Designation of a program number		P	1-9999	1-9999
Number of subprogram repetitions		P	1-999	1-999

NOTE

In ISO code, the colon (:) can also be used as the address of a program number.

- **Optional block skip**

When a slash followed by a number (/n (n=1 to 9)) is specified at the head of a block, and optional block skip switch n on the machine operator panel is set to on, the information contained in the block for which /n corresponding to switch number n is specified is ignored in DNC operation or memory operation.

When optional block skip switch n is set to off, the information contained in the block for which /n is specified is valid. This means that the operator can determine whether to skip the block containing /n.

Number 1 for /1 can be omitted. However, when two or more optional block skip switches are used for one block, number 1 for /1 cannot be omitted.

Example)

(Incorrect) (Correct)

//3 G00X10.0; /1/3 G00X10.0;

This function is ignored when programs are loaded into memory. Blocks containing /n are also stored in memory, regardless of how the optional block skip switch is set.

Programs held in memory can be output, regardless of how the optional block skip switches are set.

Optional block skip is effective even during sequence number search operation.

Depending on the machine tool, all optional block skip switches (1 to 9) may not be usable. Refer to manuals of the machine tool builder to find which switches are usable.

WARNING

1 Position of a slash

A slash (/) must be specified at the head of a block. If a slash is placed elsewhere, the information from the slash to immediately before the EOB code is ignored.

2 Disabling an optional block skip switch

Optional block skip operation is processed when blocks are read from memory or tape into a buffer. Even if a switch is set to on after blocks are read into a buffer, the blocks already read are not ignored.

NOTE

TV and TH check

When an optional block skip switch is on. TH and TV checks are made for the skipped portions in the same way as when the optional block skip switch is off.

- **Program end**

The end of a program is indicated by programming one of the following codes at the end of the program:

Table 12.2(d) Code of a program end

Code	Meaning usage
M02	For main program
M30	
M99	For subprogram

If one of the program end codes is executed in program execution, the CNC terminates the execution of the program, and the reset state is set. When the subprogram end code is executed, control returns to the program that called the subprogram.

WARNING

A block containing an optional block skip code such as /M02 ; , /M30 ; , or /M99 ; is not regarded as the end of a program, if the optional block skip switch on the machine operator's panel is set to on.
(See "Optional block skip".)

12.3 SUBPROGRAM (M98, M99)

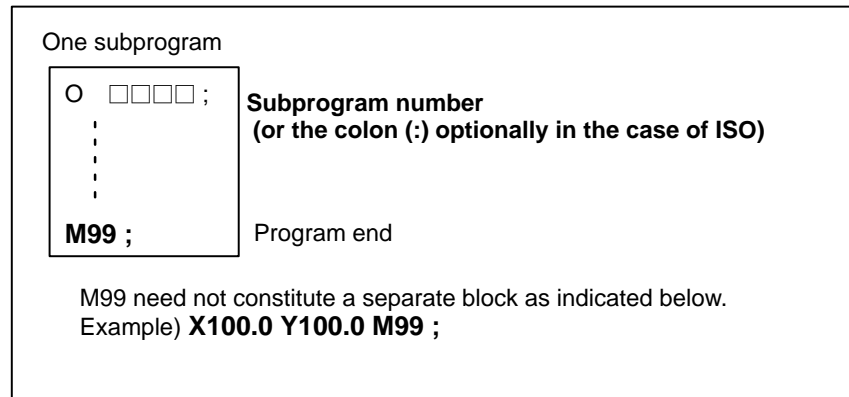
If a program contains a fixed sequence or frequently repeated pattern, such a sequence or pattern can be stored as a subprogram in memory to simplify the program.

A subprogram can be called from the main program.

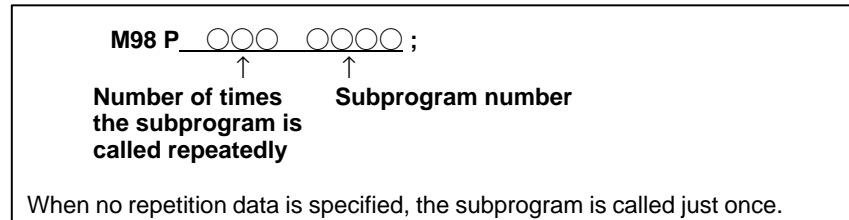
A called subprogram can also call another subprogram.

Format

- Subprogram configuration

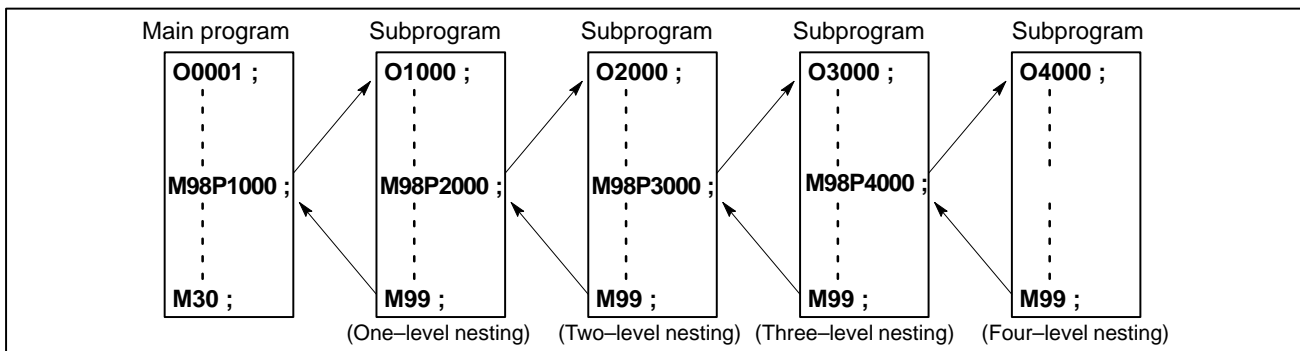


- Subprogram call



Explanations

When the main program calls a subprogram, it is regarded as a one-level subprogram call. Thus, subprogram calls can be nested up to four levels as shown below.



A single call command can repeatedly call a subprogram up to 999 times. For compatibility with automatic programming systems, in the first block, Nxxxx can be used instead of a subprogram number that follows O (or :). A sequence number after N is registered as a subprogram number.

- Reference

See III-10 for the method of registering a subprogram.

NOTE

- 1 The M98 and M99 code signal and strobe signal are not output to the machine tool.
- 2 If the subprogram number specified by address P cannot be found, an alarm (No. 078) is output.

Examples☆ **M98 P51002 ;**

This command specifies "Call the subprogram (number 1002) five times in succession." A subprogram call command (M98P_) can be specified in the same block as a move command.

☆ **X1000.0 M98 P1200 ;**

This example calls the subprogram (number 1200) after an X movement.

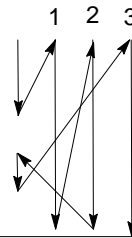
☆ Execution sequence of subprograms called from a main program

Main program

N0010 0 ;
 N0020 0 ;
 N0030 M98 P21010 ;
 N0040 0 ;
 N0050 M98 P1010 ;
 N0060 0 ;

Subprogram

O1010 0 ;
 N1020 0 ;
 N1030 0 ;
 N1040 0 ;
 N1050 0 ;
 N1060 0 M99 ;



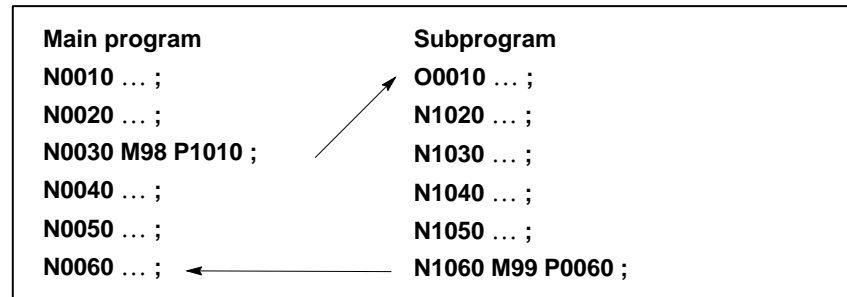
A subprogram can call another subprogram in the same way as a main program calls a subprogram.

Special Usage

- **Specifying the sequence number for the return destination in the main program**

If P is used to specify a sequence number when a subprogram is terminated, control does not return to the block after the calling block, but returns to the block with the sequence number specified by P. Note, however, that P is ignored if the main program is operating in a mode other than memory operation mode.

This method consumes a much longer time than the normal return method to return to the main program.

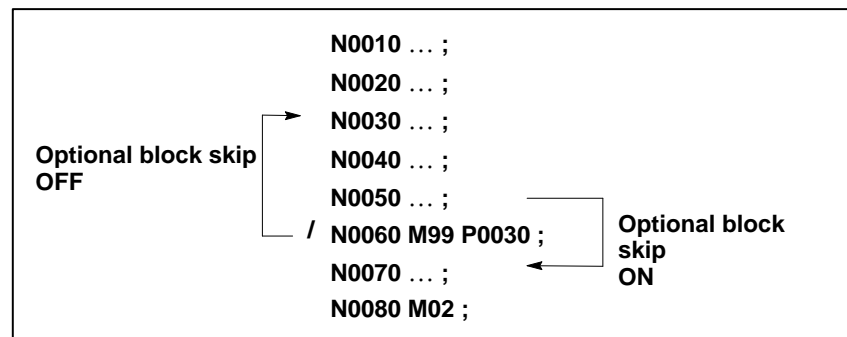


- **Using M99 in the main program**

If M99 is executed in a main program, control returns to the start of the main program. For example, M99 can be executed by placing /M99 ; at an appropriate location of the main program and setting the optional block skip function to off when executing the main program. When M99 is executed, control returns to the start of the main program, then execution is repeated starting at the head of the main program.

Execution is repeated while the optional block skip function is set to off. If the optional block skip function is set to on, the /M99 ; block is skipped ; control is passed to the next block for continued execution.

If /M99P \underline{n} ; is specified, control returns not to the start of the main program, but to sequence number n. In this case, a longer time is required to return to sequence number n.

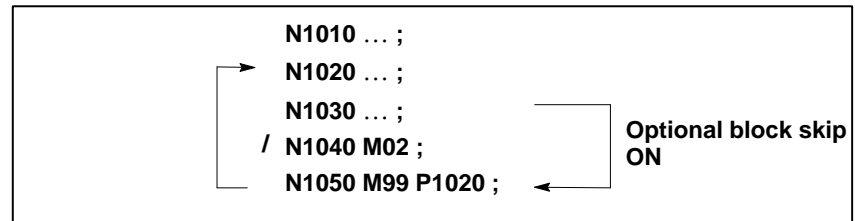


- **Using a subprogram only**

A subprogram can be executed just like a main program by searching for the start of the subprogram with the MDI.

(See III-9.3 for information about search operation.)

In this case, if a block containing M99 is executed, control returns to the start of the subprogram for repeated execution. If a block containing M99Pn is executed, control returns to the block with sequence number n in the subprogram for repeated execution. To terminate this program, a block containing /M02 ; or /M30 ; must be placed at an appropriate location, and the optional block switch must be set to off ; this switch is to be set to on first.



12.4 8-DIGIT PROGRAM NUMBER

The 8-digit program number function enables specification of program numbers with eight digits following address O (O00000001 to O99999999).

Explanations

- **Disabling editing of programs**

Editing of subprograms O00008000 to O00008999, O00009000 to O00009999, O80000000 to O89999999, and O90000000 to O99999999 can be disabled.

Parameter	Program numbers for which editing is disabled
NE8(No.3202#0)	O00008000 to O00008999
NE9(No.3202#4)	O00009000 to O00009999
PRG8E(No.3204#3)	O80000000 to O89999999
PRG9E(No.3204#4)	O90000000 to O99999999

NOTE

When a wrong password has been specified for the password function (see III-9.9), the settings of NE9 (bit 3 of parameter No. 3202) and PRG9E (bit 4 of parameter No. 3204) cannot be changed.

- **File name**

For program punch by specifying a range, files are named as follows:

When punching by specifying O00000001 and O00123456:

“O00000001-G”

When punching by specifying O12345678 and O45678900:

“O12345678-G”

When 2-path control is being applied, the file name for the first path is suffixed with “-1” and that for the second path is suffixed with “-2.”

- **Special programs**

Special subprogram numbers can be changed by using bit 5 (SPR) of parameter No. 3204.

1) Macro call using G code

Parameter used to specify G code	Program number	
	When SPR = 0	When SPR = 1
No.6050	O00009010	O90009010
No.6051	O00009011	O90009011
No.6052	O00009012	O90009012
No.6053	O00009013	O90009013
No.6054	O00009014	O90009014
No.6055	O00009015	O90009015
No.6056	O00009016	O90009016
No.6057	O00009017	O90009017
No.6058	O00009018	O90009018
No.6059	O00009019	O90009019

2) Macro call using M code

Parameter used to specify M code	Program number	
	When SPR = 0	When SPR = 1
No.6080	O00009020	O90009020
No.6081	O00009021	O90009021
No.6082	O00009022	O90009022
No.6083	O00009023	O90009023
No.6084	O00009024	O90009024
No.6085	O00009025	O90009025
No.6086	O00009026	O90009026
No.6087	O00009027	O90009027
No.6088	O00009028	O90009028
No.6089	O00009029	O90009029

3) Subprogram call using M code

Parameter used to specify M code	Program number	
	When SPR = 0	When SPR = 1
No.6071	O00009001	O90009001
No.6072	O00009002	O90009002
No.6073	O00009003	O90009003
No.6074	O00009004	O90009004
No.6075	O00009005	O90009005
No.6076	O00009006	O90009006
No.6077	O00009007	O90009007
No.6078	O00009008	O90009008
No.6079	O00009009	O90009009

4) Macro call using T code

Parameter used to specify T code	Program number	
	When SPR = 0	When SPR = 1
TCS(No.6001#5)	O00009000	O90009000

5) Macro call using ASCII code

Parameter used to specify ASCII code	Program number	
	When SPR = 0	When SPR = 1
No.6090	O00009004	O90009004
No.6091	O00009005	O90009005

6) Pattern data function

Program number	
When SPR = 0	When SPR = 1
O00009500	O90009500
O00009501	O90009501
O00009502	O90009502
O00009503	O90009503
O00009504	O90009504
O00009505	O90009505
O00009506	O90009506
O00009507	O90009507
O00009508	O90009508
O00009509	O90009509
O00009510	O90009510

- **External program number search**

External input signals can be used to search for a program number. A program stored in CNC memory can be selected by externally inputting a program number, between 1 and 99999999, to the CNC. For details, refer to the appropriate manual supplied from the machine tool builder.

Limitations

- **Subprogram call**

This function disables subprogram call unless FS15 tape format (see II-18) is used. This restriction also applies to calling a program in external I/O devices (M198).

(Example)

```
M98 P12345678 ;
```

└─ Subprogram number only. The repetition count is not included.

- **DNC**

The eight-digit program number cannot be used in DNC1, DNC2, Ethernet, data server, open CNC, and graphic conversation functions.

13

FUNCTIONS TO SIMPLIFY PROGRAMMING

General

This chapter explains the following items:

- 13.1 CANNED CYCLE
- 13.2 RIGID TAPPING
- 13.3 CANNED GRINDING CYCLE (FOR GRINDING MACHINE)
- 13.4 GRINDING WHEEL WEAR COMPENSATION BY
CONTINUOUS DRESSING (FOR GRINDING MACHINE)
- 13.5 AUTOMATIC GRINDING WHEEL DIAMETER
COMPENSATION AFTER DRESSING
- 13.6 IN-FEED GRINDING ALONG THE Y AND Z AXES AT THE END
OF TABLE SWING (FOR GRINDING MACHINE)
- 13.7 OPTIONAL ANGLE CHAMFERING AND CORNER ROUNDING
- 13.8 EXTERNAL MOTION FUNCTION
- 13.9 FIGURE COPY (G72.1, G72.2)
- 13.10 THREE-DIMENSIONAL COORDINATE CONVERSION
(G68, G69)
- 13.11 INDEX TABLE INDEXING FUNCTION

13.1 CANNED CYCLE

Canned cycles make it easier for the programmer to create programs. With a canned cycle, a frequently-used machining operation can be specified in a single block with a G function; without canned cycles, normally more than one block is required. In addition, the use of canned cycles can shorten the program to save memory.

Table 13.1 (a) lists canned cycles.

Table 13.1(a) Canned cycles

G code	Drilling(-Z direction)	Operation at the bottom of a hole	Retraction(+Z direction)	Application
G73	Intermittent feed	–	Rapid traverse	High-speed peck drilling cycle
G74	Feed	Dwell→Spindle CW	Feed	Left-hand tapping cycle
G76	Feed	Oriented spindle stop	Rapid traverse	Fine boring cycle
G80	–	–	–	Cancel
G81	Feed	–	Rapid traverse	Drilling cycle, spot drilling cycle
G82	Feed	Dwell	Rapid traverse	Drilling cycle, counter boring cycle
G83	Intermittent feed	–	Rapid traverse	Peck drilling cycle
G84	Feed	Dwell→Spindle CCW	Feed	Tapping cycle
G85	Feed	–	Feed	Boring cycle
G86	Feed	Spindle stop	Rapid traverse	Boring cycle
G87	Feed	Spindle CW	Rapid traverse	Back boring cycle
G88	Feed	Dwell→spindle stop	Manual	Boring cycle
G89	Feed	Dwell	Feed	Boring cycle

Explanations

A canned cycle consists of a sequence of six operations (Fig. 13.1 (a))

- Operation 1 Positioning of axes X and Y (including also another axis)
- Operation 2 Rapid traverse up to point R level
- Operation 3 Hole machining
- Operation 4 Operation at the bottom of a hole
- Operation 5 Retraction to point R level
- Operation 6 Rapid traverse up to the initial point

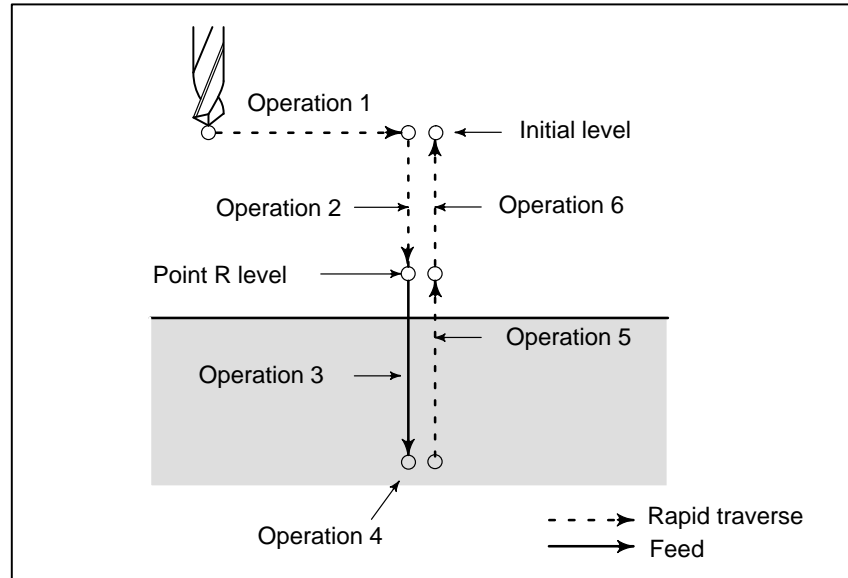


Fig. 13.1 Canned cycle operation sequence

● **Positioning plane**

The positioning plane is determined by plane selection code G17, G18, or G19.

The positioning axis is an axis other than the drilling axis.

● **Drilling axis**

Although canned cycles include tapping and boring cycles as well as drilling cycles, in this chapter, only the term drilling will be used to refer to operations implemented with canned cycles.

The drilling axis is a basic axis (X, Y, or Z) not used to define the positioning plane, or any axis parallel to that basic axis.

The axis (basic axis or parallel axis) used as the drilling axis is determined according to the axis address for the drilling axis specified in the same block as G codes G73 to G89.

If no axis address is specified for the drilling axis, the basic axis is assumed to be the drilling axis.

Table13.1(b) Positioning plane and drilling axis

G code	Positioning plane	Drilling axis
G17	Xp-Yp plane	Zp
G18	Zp-Xp plane	Yp
G19	Yp-Zp plane	Xp

Xp : X axis or an axis parallel to the X axis

Yp : Y axis or an axis parallel to the Y axis

Zp : Z axis or an axis parallel to the Z axis

Examples

Assume that the U, V and W axes be parallel to the X, Y, and Z axes respectively. This condition is specified by parameter No. 1022.

- G17 G81Z __ : The Z axis is used for drilling.
- G17 G81W __ : The W axis is used for drilling.
- G18 G81Y __ : The Y axis is used for drilling.
- G18 G81V __ : The V axis is used for drilling.
- G19 G81X __ : The X axis is used for drilling.
- G19 G81U __ : The U axis is used for drilling.

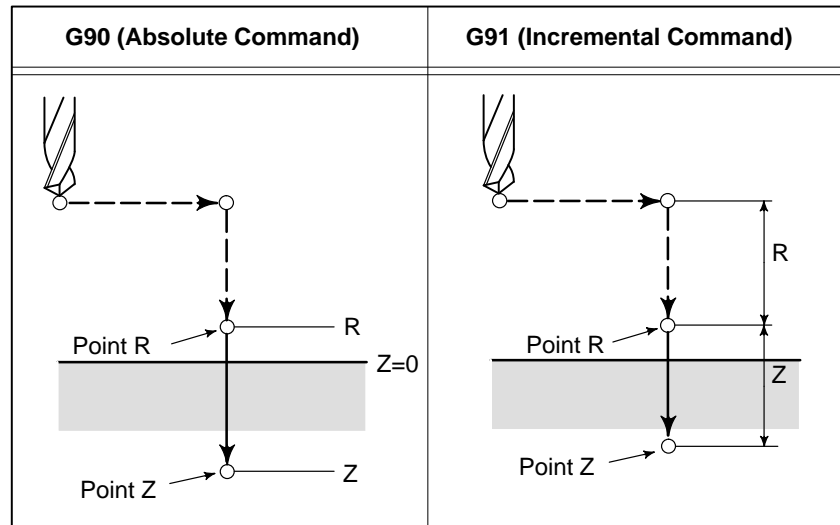
G17 to G19 may be specified in a block in which any of G73 to G89 is not specified.

WARNING
Switch the drilling axis after canceling a canned cycle.

NOTE
A parameter FXY (No. 6200 #0) can be set to the Z axis always used as the drilling axis. When FXY=0, the Z axis is always the drilling axis.

• **Travel distance along the drilling axis G90/G91**

The travel distance along the drilling axis varies for G90 and G91 as follows:



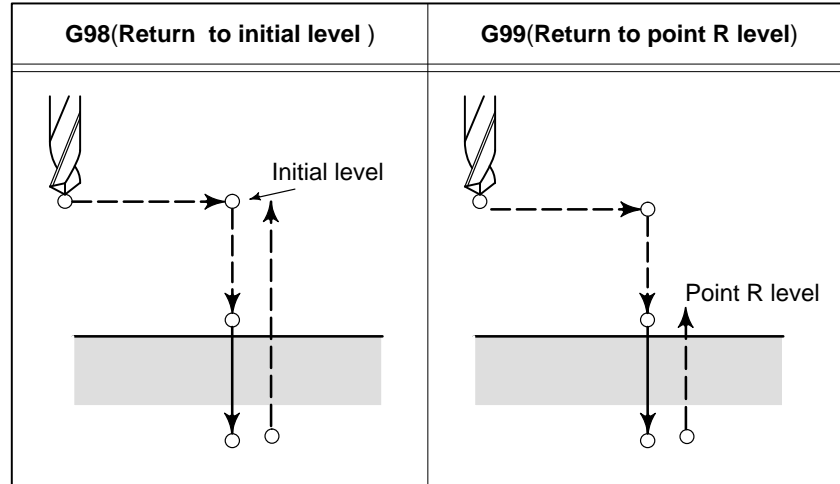
• **Drilling mode**

G73, G74, G76, and G81 to G89 are modal G codes and remain in effect until canceled. When in effect, the current state is the drilling mode. Once drilling data is specified in the drilling mode, the data is retained until modified or canceled. Specify all necessary drilling data at the beginning of canned cycles; when canned cycles are being performed, specify data modifications only.

• **Return point level G98/G99**

When the tool reaches the bottom of a hole, the tool may be returned to point R or to the initial level. These operations are specified with G98 and G99. The following illustrates how the tool moves when G98 or G99 is specified. Generally, G99 is used for the first drilling operation and G98 is used for the last drilling operation.

The initial level does not change even when drilling is performed in the G99 mode.



• **Repeat**

To repeat drilling for equally-spaced holes, specify the number of repeats in K_.

K is effective only within the block where it is specified.

Specify the first hole position in incremental mode (G91).

If it is specified in absolute mode (G90), drilling is repeated at the same position.

Number of repeats K The maximum command value = 9999

If K0 is specified, drilling data is stored, but drilling is not performed.

• **Cancel**

To cancel a canned cycle, use G80 or a group 01 G code.

Group 01 G codes

G00 : Positioning (rapid traverse)

G01 : Linear interpolation

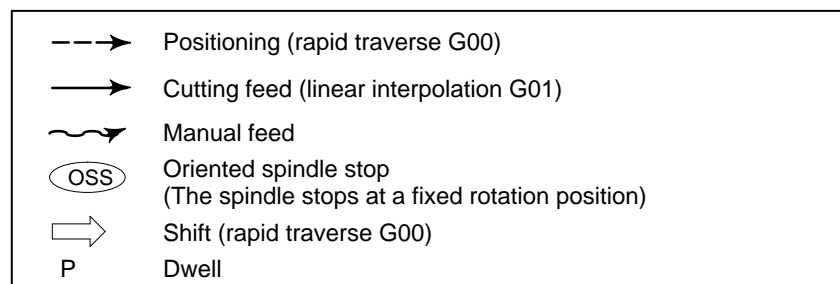
G02 : Circular interpolation or helical interpolation (CW)

G03 : Circular interpolation or helical interpolation (CCW)

G60 : Single direction positioning (when the MDL bit (bit 0 of parameter 5431) is set to 1)

• **Symbols in figures**

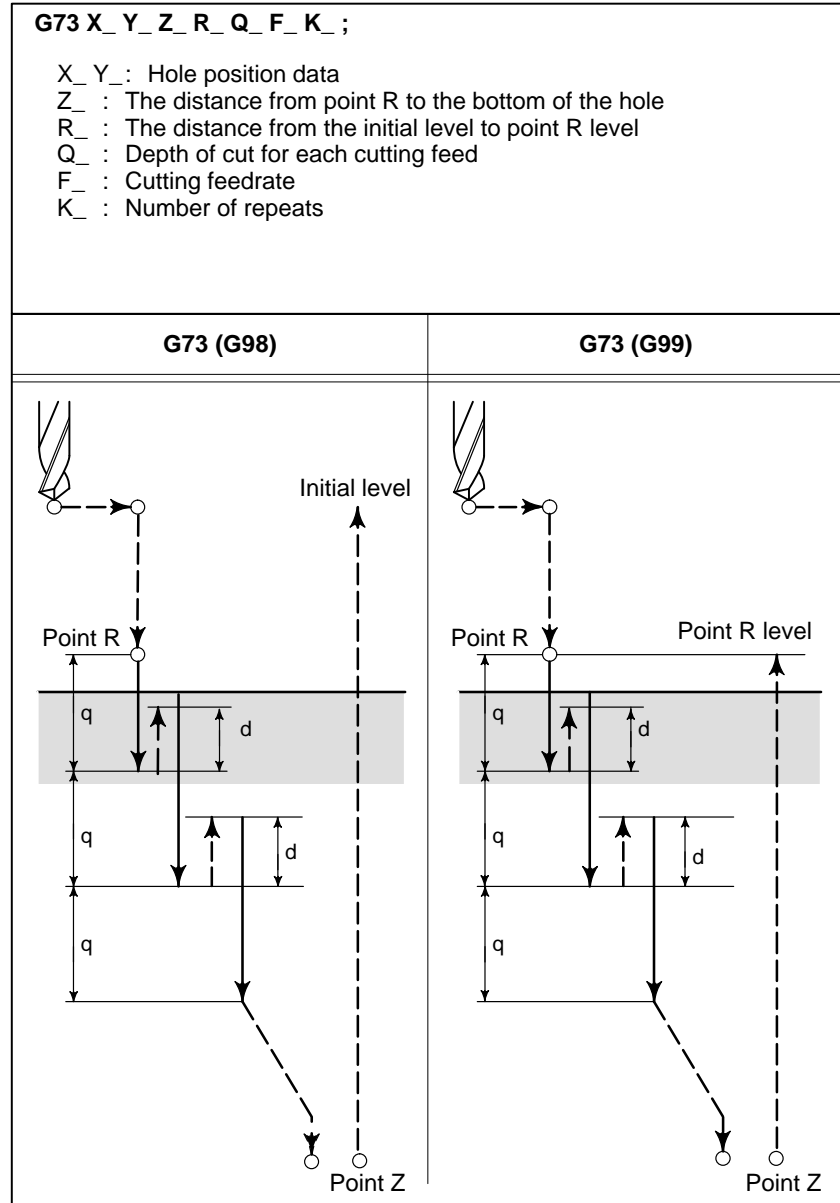
Subsequent sections explain the individual canned cycles. Figures in these explanations use the following symbols:



13.1.1 High-speed Peck Drilling Cycle (G73)

This cycle performs high-speed peck drilling. It performs intermittent cutting feed to the bottom of a hole while removing chips from the hole.

Format



Explanations

The high-speed peck drilling cycle performs intermittent feeding along the Z-axis. When this cycle is used, chips can be removed from the hole easily, and a smaller value can be set for retraction. This allows, drilling to be performed efficiently. Set the clearance, d, in parameter 5114.

The tool is retracted in rapid traverse.

Before specifying G73, rotate the spindle using a miscellaneous function (M code).

When the G73 code and an M code are specified in the same block, the M code is executed at the time of the first positioning operation. The system then proceeds to the next drilling operation.

When K is used to specify the number of repeats, the M code is executed for the first hole only; for the second and subsequent holes, the M code is not executed.

When a tool length offset (G43, G44, or G49) is specified in the canned cycle, the offset is applied at the time of positioning to point R.

Limitations

- **Axis switching** Before the drilling axis can be changed, the canned cycle must be canceled.
- **Drilling** In a block that does not contain X, Y, Z, R, or any other axes, drilling is not performed.
- **Q/R** Specify Q and R in blocks that perform drilling. If they are specified in a block that does not perform drilling, they cannot be stored as modal data.
- **Cancel** Do not specify a G code of the 01 group (G00 to G03 or G60 (when the MDL bit (bit 0 of parameter 5431) is set to 1)) and G73 in a single block. Otherwise, G73 will be canceled.
- **Tool offset** In the canned cycle mode, tool offsets are ignored.

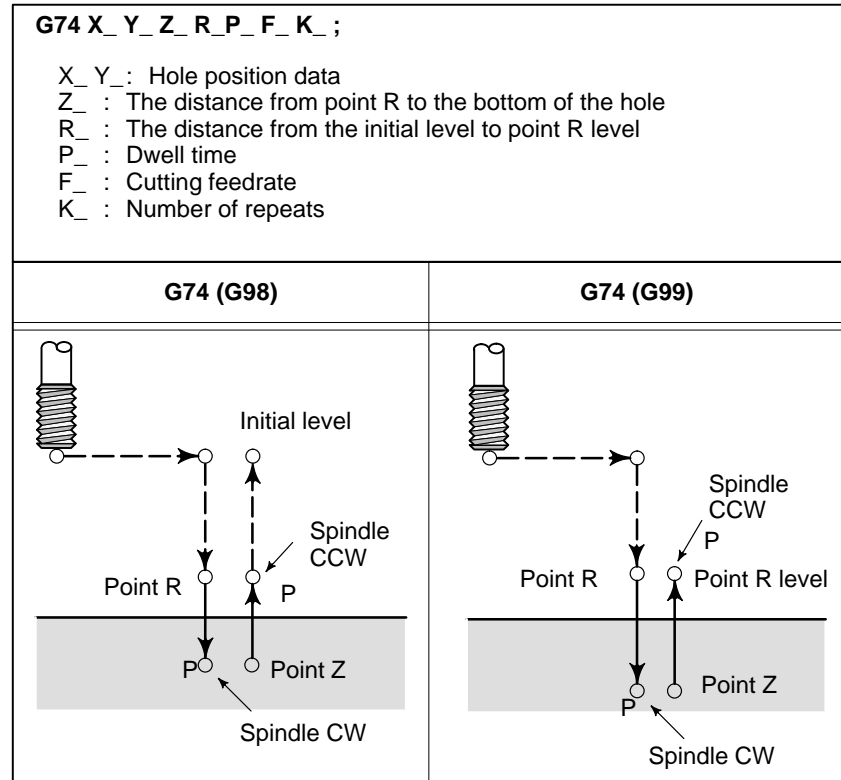
Examples

M3 S2000 ;	Cause the spindle to start rotating.
G90 G99 G73 X300. Y-250. Z-150. R-100. Q15. F120. ;	Position, drill hole 1, then return to point R.
Y-550. ;	Position, drill hole 2, then return to point R.
Y-750. ;	Position, drill hole 3, then return to point R.
X1000. ;	Position, drill hole 4, then return to point R.
Y-550. ;	Position, drill hole 5, then return to point R.
G98 Y-750. ;	Position, drill hole 6, then return to the initial level.
G80 G28 G91 X0 Y0 Z0 ;	Return to the reference position return
M5 ;	Cause the spindle to stop rotating.

13.1.2 Left-handed Tapping Cycle (G74)

Format

This cycle performs left-handed tapping. In the left-handed tapping cycle, when the bottom of the hole has been reached, the spindle rotates clockwise.



Explanations

Tapping is performed by turning the spindle counterclockwise. When the bottom of the hole has been reached, the spindle is rotated clockwise for retraction. This creates a reverse thread.

Feedrate overrides are ignored during left-handed tapping. A feed hold does not stop the machine until the return operation is completed.

Before specifying G74, use a miscellaneous function (M code) to rotate the spindle counterclockwise.

When the G74 command and an M code are specified in the same block, the M code is executed at the time of the first positioning operation. The system then proceeds to the next drilling operation.

When K is used to specify the number of repeats, the M code is executed for the first hole only; for the second and subsequent holes, the M code is not executed.

When a tool length offset (G43, G44, or G49) is specified in the canned cycle, the offset is applied at the time of positioning to point R.

Limitations

- **Axis switching** Before the drilling axis can be changed, the canned cycle must be canceled.
- **Drilling** In a block that does not contain X, Y, Z, R, or any other axes, drilling is not performed.
- **R** Specify R in blocks that perform drilling. If it is specified in a block that does not perform drilling, it cannot be stored as modal data.
- **Cancel** Do not specify a G code of the 01 group (G00 to G03 or G60 (when the MDL bit (bit 0 of parameter 5431) is set to 1)) and G74 in a single block. Otherwise, G74 will be canceled.
- **Tool offset** In the canned cycle mode, tool offsets are ignored.

Examples

M4 S100 ; Cause the spindle to start rotating.
G90 G99 G74 X300. Y-250. Z-150. R-120. F120. ;
Position, tapping hole 1, then return to point R.
Y-550. ; Position, tapping hole 2, then return to point R.
Y-750. ; Position, tapping hole 3, then return to point R.
X1000. ; Position, tapping hole 4, then return to point R.
Y-550. ; Position, tapping hole 5, then return to point R.
G98 Y-750. ; Position, tapping hole 6, then return to the
initial level.
G80 G28 G91 X0 Y0 Z0 ; Return to the reference position return
M5 ; Cause the spindle to stop rotating.

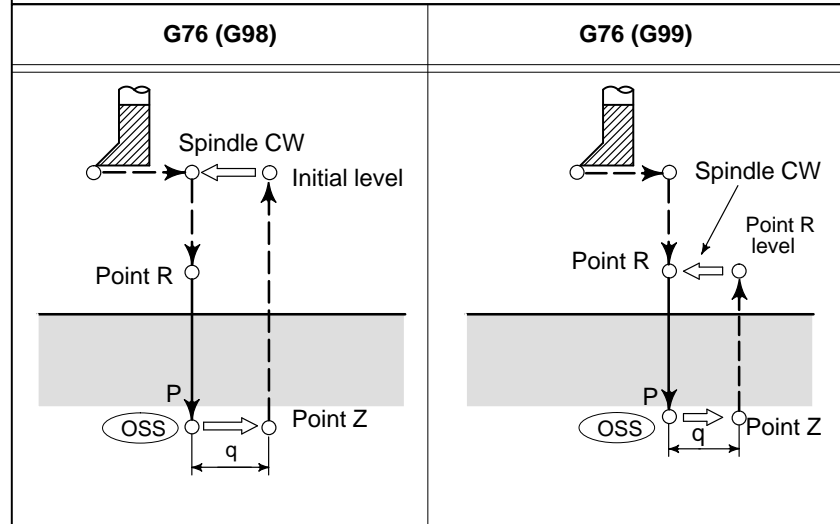
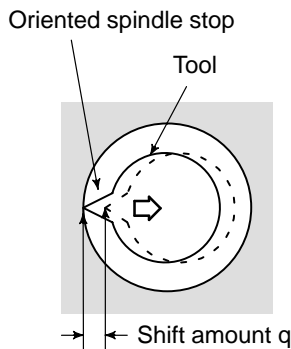
13.1.3 Fine Boring Cycle (G76)

The fine boring cycle bores a hole precisely. When the bottom of the hole has been reached, the spindle stops, and the tool is moved away from the machined surface of the workpiece and retracted.

Format

G76 X_ Y_ Z_ R_ Q_ P_ F_ K_ ;

- X_ Y_ : Hole position data
- Z_ : The distance from point R to the bottom of the hole
- R_ : The distance from the initial level to point R level
- Q_ : Shift amount at the bottom of a hole
- P_ : Dwell time at the bottom of a hole
- F_ : Cutting feedrate
- K_ : Number of repeats



WARNING

Q (shift at the bottom of a hole) is a modal value retained within canned cycles. It must be specified carefully because it is also used as the depth of cut for G73 and G83.

Explanations

When the bottom of the hole has been reached, the spindle is stopped at the fixed rotation position, and the tool is moved in the direction opposite to the tool tip and retracted. This ensures that the machined surface is not damaged and enables precise and efficient boring to be performed.

Before specifying G76, use a miscellaneous function (M code) to rotate the spindle.

When the G76 command and an M code are specified in the same block, the M code is executed at the time of the first positioning operation. The system then proceeds to the next operation.

When K is used to specify the number of repeats, the M code is executed for the first hole only; for the second and subsequent holes, the M code is not executed.

When a tool length offset (G43, G44, or G49) is specified in the canned cycle, the offset is applied at the time of positioning to point R.

Limitations

- **Axis switching**

Before the drilling axis can be changed, the canned cycle must be canceled.

- **Boring**

In a block that does not contain X, Y, Z, R, or any additional axes, boring is not performed.

- **Q/R**

Be sure to specify a positive value in Q. If Q is specified with a negative value, the sign is ignored. Set the direction of shift in bits 4 (RD1) and 5 (RD2) of parameter 5101. Specify Q and R in a block that performs boring. If they are specified in a block that does not perform boring, they are not stored as modal data.

- **Cancel**

Do not specify a G code of the 01 group (G00 to G03 or G60 (when the MDL bit (bit 0 of parameter 5431) is set to 1)) and G76 in a single block. Otherwise, G76 will be canceled.

- **Tool offset**

In the canned cycle mode, tool offsets are ignored.

Examples

M3 S500 ;	Cause the spindle to start rotating.
G90 G99 G76 X300. Y-250. Z-150. R-120. Q5.	Position, bore hole 1, then return to point R. Orient at the bottom of the hole, then shift by 5 mm.
P1000 F120. ;	Stop at the bottom of the hole for 1 s.
Y-550. ;	Position, drill hole 2, then return to point R.
Y-750. ;	Position, drill hole 3, then return to point R.
X1000. ;	Position, drill hole 4, then return to point R.
Y-550. ;	Position, drill hole 5, then return to point R.
G98 Y-750. ;	Position, drill hole 6, then return to the initial level.
G80 G28 G91 X0 Y0 Z0 ;	Return to the reference position return
M5 ;	Cause the spindle to stop rotating.

13.1.4 Drilling Cycle, Spot Drilling (G81)

This cycle is used for normal drilling. Cutting feed is performed to the bottom of the hole. The tool is then retracted from the bottom of the hole in rapid traverse.

Format

G81 X_ Y_ Z_ R_ F_ K_ ; X_ Y_ : Hole position data Z_ : The distance from point R to the bottom of the hole R_ : The distance from the initial level to point R level F_ : Cutting feedrate K_ : Number of repeats	
G81 (G98)	G81 (G99)

Explanations

After positioning along the X- and Y-axes, rapid traverse is performed to point R.

Drilling is performed from point R to point Z.

The tool is then retracted in rapid traverse.

Before specifying G81, use a miscellaneous function (M code) to rotate the spindle.

When the G81 command and an M code are specified in the same block, the M code is executed at the time of the first positioning operation. The system then proceeds to the next drilling operation.

When K is used to specify the number of repeats, the M code is performed for the first hole only; for the second and subsequent holes, the M code is not executed.

When a tool length offset (G43, G44, or G49) is specified in the canned cycle, the offset is applied at the time of positioning to point R.

Restrictions

- **Axis switching** Before the drilling axis can be changed, the canned cycle must be canceled.
- **Drilling** In a block that does not contain X, Y, Z, R, or any other axes, drilling is not performed.
- **R** Specify R in blocks that perform drilling. If it is specified in a block that does not perform drilling, it cannot be stored as modal data.
- **Cancel** Do not specify a G code of the 01 group (G00 to G03 or G60 (when the MDL bit (bit 0 of parameter 5431) is set to 1)) and G81 in a single block. Otherwise, G81 will be canceled.
- **Tool offset** In the canned cycle mode, tool offsets are ignored.

Examples

M3 S2000 ; Cause the spindle to start rotating.
G90 G99 G81 X300. Y-250. Z-150. R-100. F120. ;
Position, drill hole 1, then return to point R.
Y-550. ; Position, drill hole 2, then return to point R.
Y-750. ; Position, drill hole 3, then return to point R.
X1000. ; Position, drill hole 4, then return to point R.
Y-550. ; Position, drill hole 5, then return to point R.
G98 Y-750. ; Position, drill hole 6, then return to the initial level.
G80 G28 G91 X0 Y0 Z0 ; Return to the reference position return
M5 ; Cause the spindle to stop rotating.

13.1.5 Drilling Cycle Counter Boring Cycle (G82)

Format

This cycle is used for normal drilling.

Cutting feed is performed to the bottom of the hole. At the bottom, a dwell is performed, then the tool is retracted in rapid traverse.

This cycle is used to drill holes more accurately with respect to depth.

G82 X_ Y_ Z_ R_ P_ F_ K_ ; X_ Y_ : Hole position data Z_ : The distance from point R to the bottom of the hole R_ : The distance from the initial level to point R level P_ : Dwell time at the bottom of a hole F_ : Cutting feed rate K_ : Number of repeats	
G82 (G98)	G82 (G99)

Explanations

After positioning along the X- and Y-axes, rapid traverse is performed to point R.

Drilling is then performed from point R to point Z.

When the bottom of the hole has been reached, a dwell is performed. The tool is then retracted in rapid traverse.

Before specifying G82, use a miscellaneous function (M code) to rotate the spindle.

When the G82 command and an M code are specified in the same block, the M code is executed at the time of the first positioning operation. The system then proceeds to the next drilling operation.

When K is used to specify the number of repeats, the M code is executed for the first hole only; for the second and subsequent holes, the M code is not executed.

When a tool length offset (G43, G44, or G49) is specified in the canned cycle, the offset is applied at the time of positioning to point R.

Restrictions

- **Axis switching** Before the drilling axis can be changed, the canned cycle must be canceled.
- **Drilling** In a block that does not contain X, Y, Z, R, or any other axes, drilling is not performed.
- **R** Specify R in blocks that perform drilling. If it is specified in a block that does not perform drilling, it cannot be stored as modal data.
- **Cancel** Do not specify a G code of the 01 group (G00 to G03 or G60 (when the MDL bit (bit 0 of parameter 5431) is set to 1)) and G81 in a single block. Otherwise, G81 will be canceled.
- **Tool offset** In the canned cycle mode, tool offsets are ignored.

Examples

M3 S2000 ;	Cause the spindle to start rotating.
G90 G99 G82 X300. Y-250. Z-150. R-100. P1000 F120. ;	Position, drill hole 2, and dwell for 1 s at the bottom of the hole, then return to point R.
Y-550. ;	Position, drill hole 2, then return to point R.
Y-750. ;	Position, drill hole 3, then return to point R.
X1000. ;	Position, drill hole 4, then return to point R.
Y-550. ;	Position, drill hole 5, then return to point R.
G98 Y-750. ;	Position, drill hole 6, then return to the initial level.
G80 G28 G91 X0 Y0 Z0 ;	Return to the reference position return
M5 ;	Cause the spindle to stop rotating.

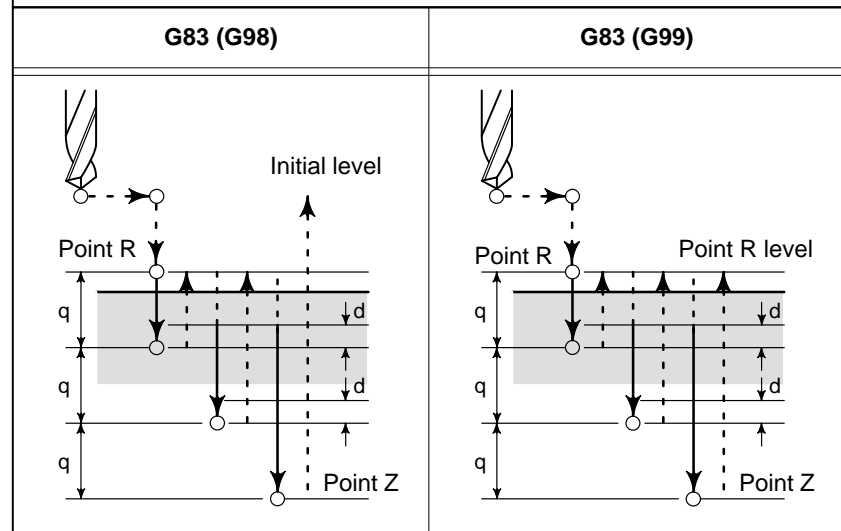
13.1.6 Peck Drilling Cycle (G83)

This cycle performs peck drilling.
It performs intermittent cutting feed to the bottom of a hole while removing shavings from the hole.

Format

G83 X_ Y_ Z_ R_ Q_ F_ K_ ;

X_ Y_ : Hole position data
Z_ : The distance from point R to the bottom of the hole
R_ : The distance from the initial level to point R level
Q_ : Depth of cut for each cutting feed
F_ : Cutting feedrate
K_ : Number of repeats



Explanations

Q represents the depth of cut for each cutting feed. It must always be specified as an incremental value.

In the second and subsequent cutting feeds, rapid traverse is performed up to a d point just before where the last drilling ended, and cutting feed is performed again. d is set in parameter (No.5115).

Be sure to specify a positive value in Q. Negative values are ignored.

Before specifying G83, use a miscellaneous function (M code) to rotate the spindle.

When the G83 command and an M code are specified in the same block, the M code is executed at the time of the first positioning operation. The system then proceeds to the next drilling operation.

When K is used to specify the number of repeats, the M code is executed for the first hole only; for the second and subsequent holes, the M code is not executed.

When a tool length offset (G43, G44, or G49) is specified in the canned cycle, the offset is applied at the time of positioning to point R.

Limitations

- **Axis switching** Before the drilling axis can be changed, the canned cycle must be canceled.
- **Drilling** In a block that does not contain X, Y, Z, R, or any other axes, drilling is not performed.
- **Q/R** Specify Q and R in blocks that perform drilling. If they are specified in a block that does not perform drilling, they cannot be stored as modal data.
- **Cancel** Do not specify a G code of the 01 group (G00 to G03 or G60 (when the MDL bit (bit 0 of parameter 5431) is set to 1)) and G82 in a single block. Otherwise, G82 will be canceled.
- **Tool offset** In the canned cycle mode, tool offsets are ignored.

Examples

M3 S2000 ;	Cause the spindle to start rotating.
G90 G99 G83 X300. Y-250. Z-150. R-100. Q15. F120. ;	
	Position, drill hole 1, then return to point R.
Y-550. ;	Position, drill hole 2, then return to point R.
Y-750. ;	Position, drill hole 3, then return to point R.
X1000. ;	Position, drill hole 4, then return to point R.
Y-550. ;	Position, drill hole 5, then return to point R.
G98 Y-750. ;	Position, drill hole 6, then return to the initial level.
G80 G28 G91 X0 Y0 Z0 ;	Return to the reference position return
M5 ;	Cause the spindle to stop rotating.

Explanations

• Component operations of the cycle

- *Positioning along the X-axis and Y-axis
- *Positioning at point R along the Z-axis
- *Drilling along the Z-axis (first drilling, depth of cut Q, incremental)
- Retraction (bottom of the hole → small clearance Δ , incremental)
- Retraction (bottom of the hole → point R)
- Advance (point R → point at a height of clearance Δ from the bottom of the hole)
- Drilling (second or subsequent drilling, depth of cut $Q + \Delta$, incremental)
- *Dwell
- *Return to point R (or initial level) along the Z-axis, cycle end

Acceleration/deceleration during advancing and retraction is controlled according to the cutting feed acceleration/deceleration time constant. When retraction is performed, the position is checked at point R.

• Specifying an M code

When the M code in parameter 5163 is specified, the system enters the mode for the small-hole peck drilling cycle.

This M code does not wait for FIN. Care must be taken when this M code is specified with another M code in the same block.

(Example) M□□ M03 ; → Waits for FIN.

M03 M□□ ; → Does not wait for FIN.

• Specifying a G code

When G83 is specified in the mode for the small-hole peck drilling cycle, the cycle is started.

This continuous-state G code remains unchanged until another canned cycle is specified or until the G code for cancelling the canned cycle is specified. This eliminates the need for specifying drilling data in each block when identical drilling is repeated.

• Signal indicating that the cycle is in progress

In this cycle, the signal indicating that the small-hole peck drilling cycle is in progress is output after the tool is positioned at the hole position along the axes not used for drilling. Signal output continues during positioning to point R along the drilling axis and terminates upon a return to point R or the initial level. For details, refer to the manual of the machine tool builder.

• Overload torque detection signal

A skip signal is used as the overload torque detection signal. The skip signal is effective while the tool is advancing or drilling and the tool tip is between points R and Z. (The signal causes a retraction). For details, refer to the manual of the machine tool builder.

- **Changing the drilling conditions**

In a single G83 cycle, drilling conditions are changed for each drilling operation (advance → drilling → retraction). Bits 1 and 2 of parameter OLS, NOL No. 5160 can be specified to suppress the change in drilling conditions.

1. **Changing the cutting feedrate**

The cutting feedrate programmed with the F code is changed for each of the second and subsequent drilling operations. In parameters No.5166 and No.5167, specify the respective rates of change applied when the skip signal is detected and when it is not detected in the previous drilling operation.

$$\text{Cutting feedrate} = F \times \alpha$$

<First drilling> $\alpha = 1.0$

<Second or subsequent drilling> $\alpha = \alpha \times \beta \div 100$, where β is the rate of change for each drilling operation

When the skip signal is detected during the previous drilling operation
: $\beta = b1\%$ (parameter No. 5166)

When the skip signal is not detected during the previous drilling operation:
: $\beta = b2\%$ (parameter No. 5167)

If the rate of change in cutting feedrate becomes smaller than the rate specified in parameter 5168, the cutting feedrate is not changed. The cutting feedrate can be increased up to the maximum cutting feedrate.

2. **Changing the spindle speed**

The spindle speed programmed with the S code is changed for each of the second and subsequent advances. In parameters 5164 and 5165, specify the rates of change applied when the skip signal is detected and when it is not detected in the previous drilling operation.

$$\text{Spindle speed} = S \times \gamma$$

<First drilling> $\gamma = 1.0$

<Second or subsequent drilling> $\gamma = \gamma \times \delta \div 100$, where δ is the rate of change for each drilling operation

When the skip signal is detected during the previous drilling operation
: $\delta = b1\%$ (parameter No. 5164)

When the skip signal is not detected during the previous drilling operation:
: $\delta = b2\%$ (parameter No. 5165)

When the cutting feedrate reaches the minimum rate, the spindle speed is not changed. The spindle speed can be increased up to a value corresponding to the maximum value of S analog data.

- **Advance and retraction**

Advancing and retraction of the tool are not executed in the same manner as rapid-traverse positioning. Like cutting feed, the two operations are carried out as interpolated operations. The speed is subjected to exponential acceleration/deceleration. Note that the tool life management function excludes advancing and retraction from the calculation of the tool life.

- **Specifying address I**

The forward or backward traveling speed can be specified with address I in the same format as address F, as shown below:

G83 I1000 ; (without decimal point)

G83 I1000.; (with decimal point)

Both commands indicate a speed of 1000 mm/min.

Address I specified with G83 in the continuous-state mode continues to be valid until G80 is specified or until a reset occurs.

- **Functions that can be specified**

In this canned cycle mode, the following functions can be specified:

- Hole position on the X-axis, Y-axis, and additional axis
- Operation and branch by custom macro
- Subprogram (hole position group, etc.) calling
- Switching between absolute and incremental modes
- Coordinate system rotation
- Scaling (This command will not affect depth of cut Q or small clearance d1.)
- Dry run
- Feed hold

- **Single block**

When single-block operation is enabled, drilling is stopped after each retraction.

- **Feedrate override**

The feedrate override function works during cutting, retraction, and advancing in the cycle.

- **Custom macro interface**

The number of retractions made during cutting and the number of retractions made in response to the overload signal received during cutting can be output to custom macro common variables (#100 to #149) specified in parameters No.5170 and No.5171. Parameters No.5170 and No.5171 can specify variable numbers within the range of #100 to #149.

Parameter No.5170 : Specifies the number of the common variable to which the number of retractions made during cutting is output.

Parameter No.5171: Specifies the number of the common variable to which the number of retractions made in response to the overload signal received during cutting is output.

Examples

```

N01M03 S___ ;
N02M□□ ;
N03G83 X_ Y_ Z_ R_ Q_ F_ I_ K_ P_ ;
N04X_ Y_ ;
:
:
N10G80 ;

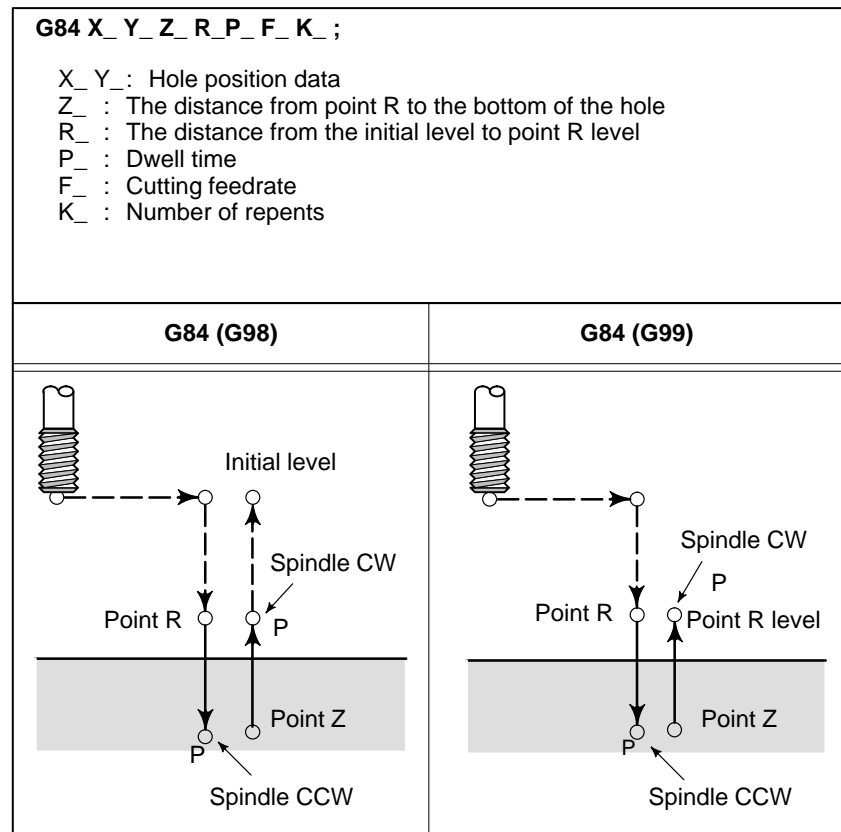
```

<Description of each block>

- N01:** Specifies forward spindle rotation and spindle speed.
- N02:** Specifies the M code to execute **G83** as the small-hole peck drilling cycle. The M code is specified in parameter No.5163.
- N03:** Specifies the small-hole peck drilling cycle. Drilling data (except K and P) is stored and drilling is started.
- N04:** Drills a small, deep hole at another position with the same drilling data as for **N03**.
- N10:** Cancels the small-hole peck drilling cycle. The M code specified in **N02** is also canceled.

13.1.8 Tapping Cycle (G84)

This cycle performs tapping. In this tapping cycle, when the bottom of the hole has been reached, the spindle is rotated in the reverse direction.

Format

Explanations

Tapping is performed by rotating the spindle clockwise. When the bottom of the hole has been reached, the spindle is rotated in the reverse direction for retraction. This operation creates threads.

Feedrate overrides are ignored during tapping. A feed hold does not stop the machine until the return operation is completed.

Before specifying G84, use a miscellaneous function (M code) to rotate the spindle.

When the G84 command and an M code are specified in the same block, the M code is executed at the time of the first positioning operation. The system then proceeds to the next drilling operation.

When the K is used to specify number of repeats, the M code is executed for the first hole only; for the second and subsequent holes, the M code is not executed.

When a tool length offset (G43, G44, or G49) is specified in the canned cycle, the offset is applied at the time of positioning to point R.

Limitations

- **Axis switching** Before the drilling axis can be changed, the canned cycle must be canceled.
- **Drilling** In a block that does not contain X, Y, Z, R, or any other axes, drilling is not performed.
- **R** Specify R in blocks that perform drilling. If it is specified in a block that does not perform drilling, it cannot be stored as modal data.
- **Cancel** Do not specify a G code of the 01 group (G00 to G03 or G60 (when the MDL bit (bit 0 of parameter 5431) is set to 1)) and G84 in a single block. Otherwise, G84 will be canceled.
- **Tool offset** In the canned cycle mode, tool offsets are ignored.

Examples

M3 S100 ;	Cause the spindle to start rotating.
G90 G99 G84 X300. Y-250. Z-150. R-120. P300 F120. ;	Position, drill hole 1, then return to point R.
Y-550. ;	Position, drill hole 2, then return to point R.
Y-750. ;	Position, drill hole 3, then return to point R.
X1000. ;	Position, drill hole 4, then return to point R.
Y-550. ;	Position, drill hole 5, then return to point R.
G98 Y-750. ;	Position, drill hole 6, then return to the initial level.
G80 G28 G91 X0 Y0 Z0 ;	Return to the reference position return
M5 ;	Cause the spindle to stop rotating.

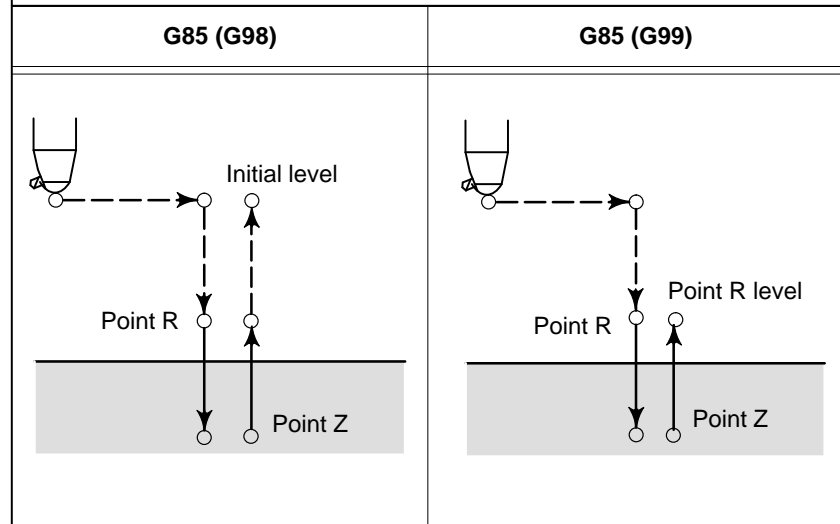
13.1.9 Boring Cycle (G85)

This cycle is used to bore a hole.

Format

G85 X_ Y_ Z_ R_ F_ K_ ;

X_ Y_ : Hole position data
Z_ : The distance from point R to the bottom of the hole
R_ : The distance from the initial level to point R level
F_ : Cutting feed rate
K_ : Number of repeats



Explanations

After positioning along the X- and Y- axes, rapid traverse is performed to point R.

Drilling is performed from point R to point Z.

When point Z has been reached, cutting feed is performed to return to point R.

Before specifying G85, use a miscellaneous function (M code) to rotate the spindle.

When the G85 command and an M code are specified in the same block, the M code is executed at the time of the first positioning operation. The system then proceeds to the next drilling operation.

When K is used to specify the number of repeats, the M code is executed for the first hole only; for the second and subsequent holes, the M code is not executed.

When a tool length offset (G43, G44, or G49) is specified in the canned cycle, the offset is applied at the time of positioning to point R.

Limitations

- **Axis switching** Before the drilling axis can be changed, the canned cycle must be canceled.
- **Drilling** In a block that does not contain X, Y, Z, R, or any other axes, drilling is not performed.
- **R** Specify R in blocks that perform drilling. If it is specified in a block that does not perform drilling, it cannot be stored as modal data.
- **Cancel** Do not specify a G code of the 01 group (G00 to G03 or G60 (when the MDL bit (bit 0 of parameter 5431) is set to 1)) and G85 in a single block. Otherwise, G85 will be canceled.
- **Tool offset** In the canned cycle mode, tool offsets are ignored.

Examples

M3 S100 ;	Cause the spindle to start rotating.
G90 G99 G85 X300. Y-250. Z-150. R-120. F120. ;	Position, drill hole 1, then return to point R.
Y-550. ;	Position, drill hole 2, then return to point R.
Y-750. ;	Position, drill hole 3, then return to point R.
X1000. ;	Position, drill hole 4, then return to point R.
Y-550. ;	Position, drill hole 5, then return to point R.
G98 Y-750. ;	Position, drill hole 6, then return to the initial level.
G80 G28 G91 X0 Y0 Z0 ;	Return to the reference position return
M5 ;	Cause the spindle to stop rotating.

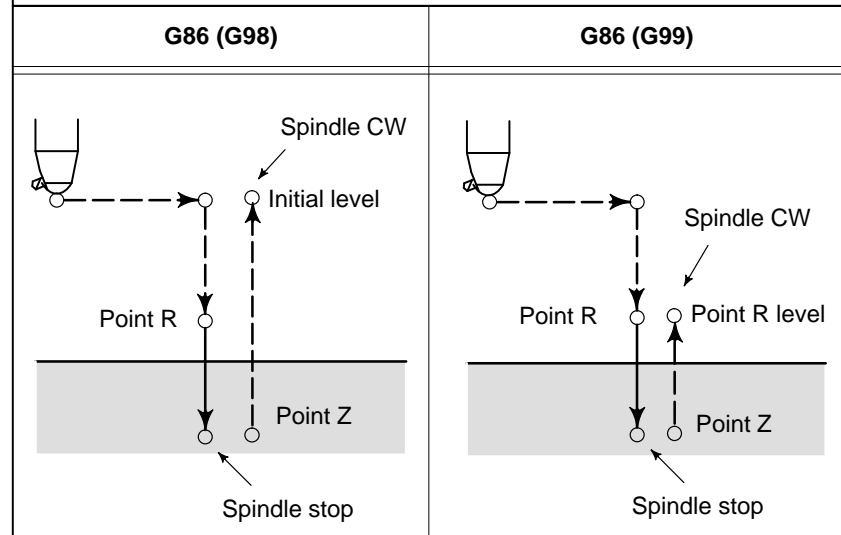
13.1.10 Boring Cycle (G86)

This cycle is used to bore a hole.

Format

G86 X_ Y_ Z_ R_ F_ K_ ;

X_ Y_ : Hole position data
Z_ : The distance from point R to the bottom of the hole
R_ : The distance from the initial level to point R level
F_ : Cutting feed rate
K_ : Number of repeats



Explanations

After positioning along the X- and Y-axes, rapid traverse is performed to point R.

Drilling is performed from point R to point Z.

When the spindle is stopped at the bottom of the hole, the tool is retracted in rapid traverse.

Before specifying G86, use a miscellaneous function (M code) to rotate the spindle.

When the G86 command and an M code are specified in the same block, the M code is executed at the time of the first positioning operation.

The system then proceeds to the next drilling operation.

When K is used to specify the number of repeats, the M code is executed for the first hole only; for the second and subsequent holes, the M code is not executed.

When a tool length offset (G43, G44, or G49) is specified in the canned cycle, the offset is applied at the time of positioning to point R.

Limitations

- **Axis switching** Before the drilling axis can be changed, the canned cycle must be canceled.
- **Drilling** In a block that does not contain X, Y, Z, R, or any other axes, drilling is not performed.
- **R** Specify R in blocks that perform drilling. If it is specified in a block that does not perform drilling, it cannot be stored as modal data.
- **Cancel** Do not specify a G code of the 01 group (G00 to G03 or G60 (when the MDL bit (bit 0 of parameter 5431) is set to 1)) and G86 in a single block. Otherwise, G86 will be canceled.
- **Tool offset** In the canned cycle mode, tool offsets are ignored.

Examples

M3 S2000 ;	Cause the spindle to start rotating.
G90 G99 G86 X300. Y-250. Z-150. R-100. F120. ;	Position, drill hole 1, then return to point R.
Y-550. ;	Position, drill hole 2, then return to point R.
Y-750. ;	Position, drill hole 3, then return to point R.
X1000. ;	Position, drill hole 4, then return to point R.
Y-550. ;	Position, drill hole 5, then return to point R.
G98 Y-750. ;	Position, drill hole 6, then return to the initial level.
G80 G28 G91 X0 Y0 Z0 ;	Return to the reference position return
M5 ;	Cause the spindle to stop rotating.

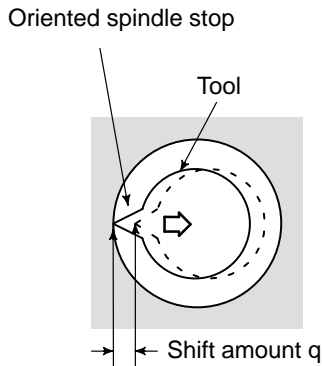
13.1.11 Boring Cycle Back Boring Cycle (G87)

This cycle performs accurate boring.

Format

G87 X_ Y_ Z_ R_ Q_ P_ F_ K_ ;

- X_ Y_ : Hole position data
- Z_ : The distance from the bottom of the hole to point Z
- R_ : The distance from the initial level to point R (the bottom of the hole) level
- Q_ : Tool shift amount
- P_ : Dwell time
- F_ : Cutting feed rate
- K_ : Number of repeats



G87 (G98)	G87 (G99)
	<p>Not used</p>

WARNING

Q (shift at the bottom of a hole) is a modal value retained in canned cycles. It must be specified carefully because it is also used as the depth of cut for G73 and G83.

Explanations

After positioning along the X– and Y–axes, the spindle is stopped at the fixed rotation position. The tool is moved in the direction opposite to the tool tip, positioning (rapid traverse) is performed to the bottom of the hole (point R).

The tool is then shifted in the direction of the tool tip and the spindle is rotated clockwise. Boring is performed in the positive direction along the Z–axis until point Z is reached.

At point Z, the spindle is stopped at the fixed rotation position again, the tool is shifted in the direction opposite to the tool tip, then the tool is returned to the initial level. The tool is then shifted in the direction of the tool tip and the spindle is rotated clockwise to proceed to the next block operation.

Before specifying G87, use a miscellaneous function (M code) to rotate the spindle.

When the G87 command and an M code are specified in the same block, the M code is executed at the time of the first positioning operation.

The system then proceeds to the next drilling operation. When K is used to specify the number of repeats, the M code is executed for the first hole only; for the second and subsequent holes, the M code is not executed.

When a tool length offset (G43, G44, or G49) is specified in the canned cycle, the offset is applied at the time of positioning to point R.

Restrictions

- **Axis switching** Before the drilling axis can be changed, the canned cycle must be canceled.
- **Boring** In a block that does not contain X, Y, Z, R, or any additional axes, boring is not performed.
- **Q/R** Be sure to specify a positive value in Q. If Q is specified with a negative value, the sign is ignored. Set the direction of shift in bits 4 (RD1) and 5 (RD2) of parameter No.5101. Specify Q and R in a block that performs boring. If they are specified in a block that does not perform boring, they are not stored as modal data.
- **Cancel** Do not specify a G code of the 01 group (G00 to G03 or G60 (when the MDL bit (bit 0 of parameter 5431) is set to 1)) and G87 in a single block. Otherwise, G87 will be canceled.
- **Tool offset** In the canned cycle mode, tool offsets are ignored.

Examples

M3 S500 ;	Cause the spindle to start rotating.
G90 G87 X300. Y–250.	Position, bore hole 1.
 Z–150. R–120. Q5.	Orient at the initial level, then shift by 5 mm.
P1000 F120. ;	Stop at point Z for 1 s.
Y–550. ;	Position, drill hole 2.
Y–750. ;	Position, drill hole 3.
X1000. ;	Position, drill hole 4.
Y–550. ;	Position, drill hole 5.
Y–750. ;	Position, drill hole 6
G80 G28 G91 X0 Y0 Z0 ;	Return to the reference position return
M5 ;	Cause the spindle to stop rotating.

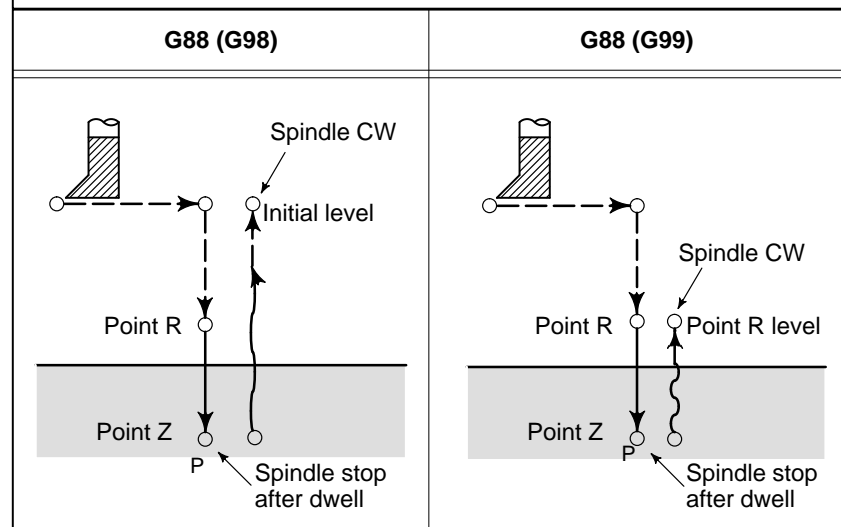
13.1.12 Boring Cycle (G88)

This cycle is used to bore a hole.

Format

G88 X_ Y_ Z_ R_ P_ F_ K_ ;

X_ Y_ : Hole position data
Z_ : The distance from point R to the bottom of the hole
R_ : The distance from the initial level to point R level
P_ : Dwell time at the bottom of a hole
F_ : Cutting feed rate
K_ : Number of repeats



Explanations

After positioning along the X- and Y-axes, rapid traverse is performed to point R. Boring is performed from point R to point Z. When boring is completed, a dwell is performed, then the spindle is stopped. The tool is manually retracted from the bottom of the hole (point Z) to point R. At point R, the spindle is rotated clockwise, and rapid traverse is performed to the initial level.

Before specifying G88, use a miscellaneous function (M code) to rotate the spindle.

When the G88 command and an M code are specified in the same block, the M code is executed at the time of the first positioning operation. The system then proceeds to the next drilling operation.

When K is used to specify the number of repeats, the M code is executed for the first hole only; for the second and subsequent holes, the M code is not executed.

When a tool length offset (G43, G44, or G49) is specified in the canned cycle, the offset is applied at the time of positioning to point R.

Limitations

- **Axis switching** Before the drilling axis can be changed, the canned cycle must be canceled.
- **Drilling** In a block that does not contain X, Y, Z, R, or any other axes, drilling is not performed.
- **R** Specify R in blocks that perform drilling. If it is specified in a block that does not perform drilling, it cannot be stored as modal data.
- **Cancel** Do not specify a G code of the 01 group (G00 to G03 or G60 (when the MDL bit (bit 0 of parameter 5431) is set to 1)) and G88 in a single block. Otherwise, G88 will be canceled.
- **Tool offset** In the canned cycle mode, tool offsets are ignored.

Examples

M3 S2000 ;	Cause the spindle to start rotating.
G90 G99 G88 X300. Y-250. Z-150. R-100. P1000 F120. ;	Position, drill hole 1, return to point R then stop at the bottom of the hole for 1 s.
Y-550. ;	Position, drill hole 2, then return to point R.
Y-750. ;	Position, drill hole 3, then return to point R.
X1000. ;	Position, drill hole 4, then return to point R.
Y-550. ;	Position, drill hole 5, then return to point R.
G98 Y-750. ;	Position, drill hole 6, then return to the initial level.
G80 G28 G91 X0 Y0 Z0 ;	Return to the reference position return
M5 ;	Cause the spindle to stop rotating.

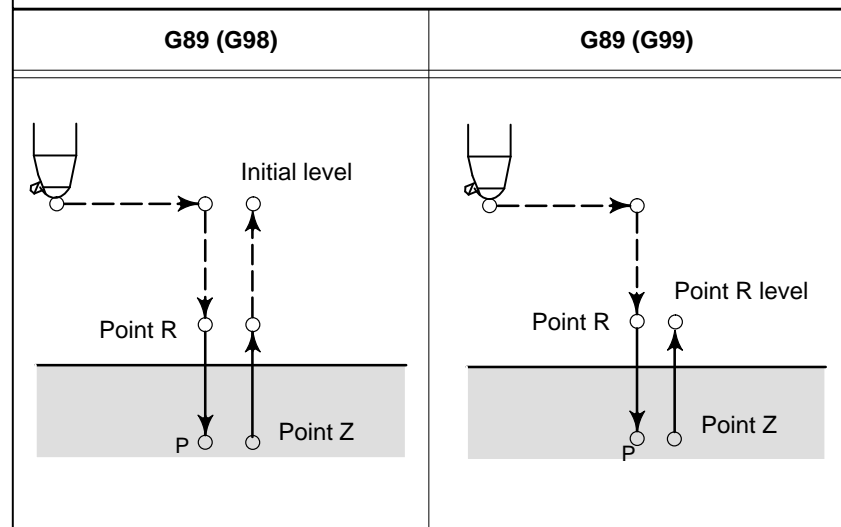
13.1.13 Boring Cycle (G89)

This cycle is used to bore a hole.

Format

G89 X_ Y_ Z_ R_ P_ F_ K_ ;

X_ Y_ : Hole position data
 Z_ : The distance from point R to the bottom of the hole
 R_ : The distance from the initial level to point R level
 P_ : Dwell time at the bottom of a hole
 F_ : Cutting feed rate
 K_ : Number of repeats



Explanations

This cycle is almost the same as G85. The difference is that this cycle performs a dwell at the bottom of the hole.

Before specifying G89, use a miscellaneous function (M code) to rotate the spindle.

When the G89 command and an M code are specified in the same block, the M code is executed at the time of the first positioning operation. The system then proceeds to the next drilling operation.

When K is used to specify the number of repeats, the M code is executed for the first hole only; for the second and subsequent holes, the M code is not executed.

When a tool length offset (G43, G44, or G49) is specified in the canned cycle, the offset is applied at the time of positioning to point R.

Limitations

- **Axis switching** Before the drilling axis can be changed, the canned cycle must be canceled.
- **Drilling** In a block that does not contain X, Y, Z, R, or any other axes, drilling is not performed.
- **R** Specify R in blocks that perform drilling. If it is specified in a block that does not perform drilling, it cannot be stored as modal data.
- **Cancel** Do not specify a G code of the 01 group (G00 to G03 or G60 (when the MDL bit (bit 0 of parameter 5431) is set to 1)) and G89 in a single block. Otherwise, G89 will be canceled.
- **Tool offset** In the canned cycle mode, tool offsets are ignored.

Examples

M3 S100 ;	Cause the spindle to start rotating.
G90 G99 G89 X300. Y-250. Z-150. R-120. P1000 F120. ;	Position, drill hole 1, return to point R then stop at the bottom of the hole for 1 s.
Y-550. ;	Position, drill hole 2, then return to point R.
Y-750. ;	Position, drill hole 3, then return to point R.
X1000. ;	Position, drill hole 4, then return to point R.
Y-550. ;	Position, drill hole 5, then return to point R.
G98 Y-750. ;	Position, drill hole 6, then return to the initial level.
G80 G28 G91 X0 Y0 Z0 ;	Return to the reference position return
M5 ;	Cause the spindle to stop rotating.

13.1.14 Canned Cycle Cancel (G80)

G80 cancels canned cycles.

Format

```
G80 ;
```

Explanations

All canned cycles are canceled to perform normal operation. Point R and point Z are cleared. This means that R = 0 and Z = 0 in incremental mode. Other drilling data is also canceled (cleared).

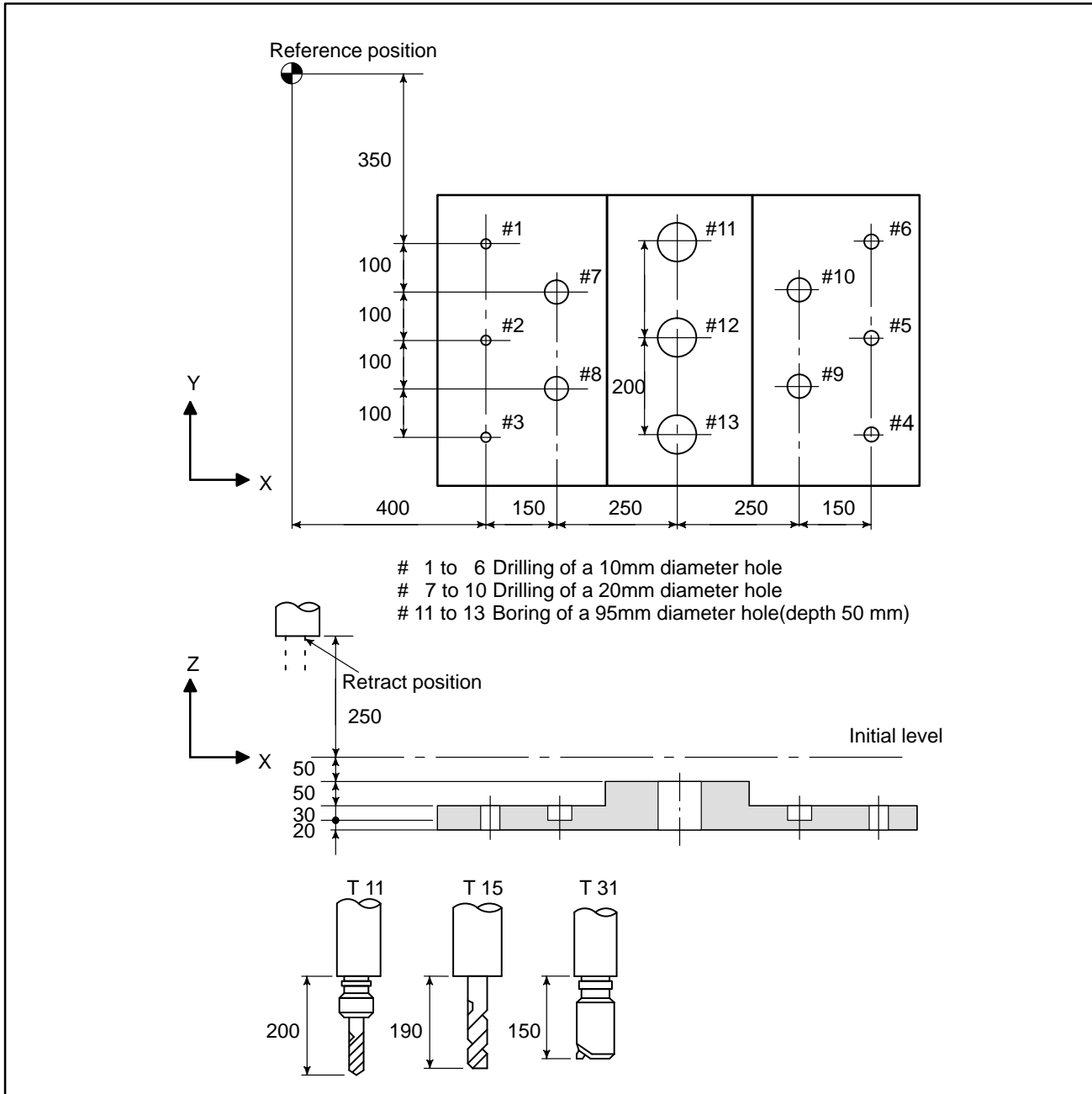
Examples

```

M3 S100 ;      Cause the spindle to start rotating.
G90 G99 G88 X300. Y-250. Z-150. R-120. F120. ;
               Position, drill hole 1, then return to point R.
Y-550. ;      Position, drill hole 2, then return to point R.
Y-750. ;      Position, drill hole 3, then return to point R.
X1000. ;      Position, drill hole 4, then return to point R.
Y-550. ;      Position, drill hole 5, then return to point R.
G98 Y-750. ;  Position, drill hole 6, then return to the initial level.
G80 G28 G91 X0 Y0 Z0 ;
               Return to the reference position return,
               canned cycle cancel
M5 ;          Cause the spindle to stop rotating.

```

Program example using tool length offset and canned cycles



Offset value +200.0 is set in offset No.11, +190.0 is set in offset No.15, and +150.0 is set in offset No.31

Program example

```

;
N001 G92X0Y0Z0;           Coordinate setting at reference position
N002 G90 G00 Z250.0 T11 M6; Tool change
N003 G43 Z0 H11;          Initial level, tool length offset
N004 S30 M3                Spindle start
N005 G99 G81X400.0 R Y-350.0
      Z-153.0R-97.0 F120;   Positioning, then #1 drilling
N006 Y-550.0;             Positioning, then #2 drilling and point R level return
N007 G98Y-750.0;          Positioning, then #3 drilling and initial level return
N008 G99X1200.0;          Positioning, then #4 drilling and point R level return
N009 Y-550.0;             Positioning, then #5 drilling and point R level return
N010 G98Y-350.0;          Positioning, then #6 drilling and initial level return
N011 G00X0Y0M5;           Reference position return, spindle stop
N012 G49Z250.0T15M6;      Tool length offset cancel, tool change
N013 G43Z0H15;            Initial level, tool length offset
N014 S20M3;                Spindle start
N015 G99G82X550.0Y-450.0
      Z-130.0R-97.0P300F70; Positioning, then #7 drilling, point R level return
N016 G98Y-650.0;          Positioning, then #8 drilling, initial level return
N017 G99X1050.0;          Positioning, then #9 drilling, point R level return
N018 G98Y-450.0;          Positioning, then #10 drilling, initial level return
N019 G00X0Y0M5;           Reference position return, spindle stop
N020 G49Z250.0T31M6;      Tool length offset cancel, tool change
N021 G43Z0H31;            Initial level, tool length offset
N022 S10M3;                Spindle start
N023 G85G99X800.0Y-350.0
      Z-153.0R47.0F50;     Positioning, then #11 drilling, point R level return
N024 G91Y-200.0K2;        Positioning, then #12, 13 drilling. point R level return
N025 G28X0Y0M5;           Reference position return, spindle stop
N026 G49Z0;                Tool length offset cancel
N027 M0;                    Program stop

```


13.2 RIGID TAPPING

The tapping cycle (G84) and left-handed tapping cycle (G74) may be performed in standard mode or rigid tapping mode.

In standard mode, the spindle is rotated and stopped along with a movement along the tapping axis using miscellaneous functions M03 (rotating the spindle clockwise), M04 (rotating the spindle counterclockwise), and M05 (stopping the spindle) to perform tapping. In rigid mode, tapping is performed by controlling the spindle motor as if it were a servo motor and by interpolating between the tapping axis and spindle.

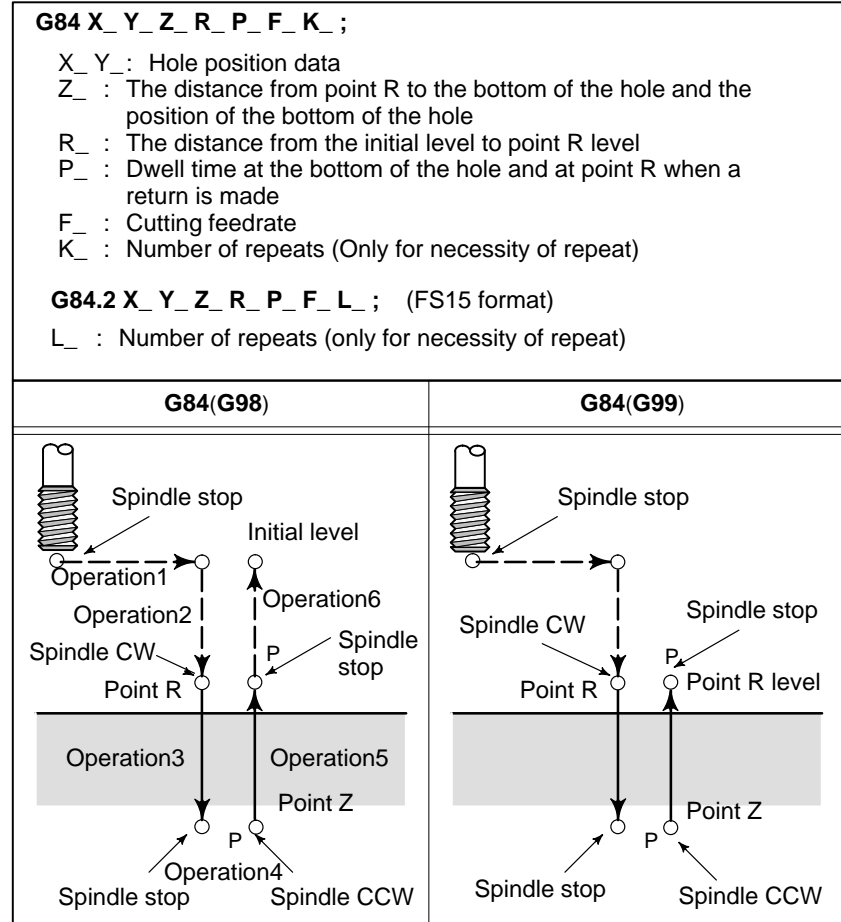
When tapping is performed in rigid mode, the spindle rotates one turn every time a certain feed (thread lead) which takes place along the tapping axis. This operation does not vary even during acceleration or deceleration.

Rigid mode eliminates the need to use a floating tap required in the standard tapping mode, thus allowing faster and more precise tapping.

13.2.1 Rigid Tapping (G84)

Format

When the spindle motor is controlled in rigid mode as if it were a servo motor, a tapping cycle can be sped up.



Explanations

After positioning along the X- and Y-axes, rapid traverse is performed to point R.

Tapping is performed from point R to point Z. When tapping is completed, the spindle is stopped and a dwell is performed. The spindle is then rotated in the reverse direction, the tool is retracted to point R, then the spindle is stopped. Rapid traverse to initial level is then performed. While tapping is being performed, the feedrate override and spindle override are assumed to be 100%.

However, the speed for extraction (operation 5) can be overridden by up to 200% depending on the setting at bit 4 (DOV) of parameter No.5200 and parameter No.5211.

• Rigid mode

Rigid mode can be specified using any of the following methods:

- Specify **M29 S******* before a tapping command.
- Specify **M29 S******* in a block which contains a tapping command.
- Specify **G84** for rigid tapping (parameter **G84 No. 5200 #0** set to 1).

- **Thread lead** In feed-per-minute mode, the thread lead is obtained from the expression, feedrate × spindle speed. In feed-per-revolution mode, the thread lead equals the feedrate speed.
- **Tool length compensation** If a tool length compensation (G43, G44, or G49) is specified in the canned cycle, the offset is applied at the time of positioning to point R.
- **FS15-format command** Rigid tapping can be performed using FS15-format commands. Rigid tapping (Including data transfer to and from the PMC) is performed according to the sequence for the FS16/18.

Limitations

- **Axis switching** Before the drilling axis can be changed, the canned cycle must be canceled. If the drilling axis is changed in rigid mode, P/S alarm (No. 206) is issued.
- **S command** If a speed higher than the maximum speed for the gear being used is specified, P/S alarm (No. 200) is issued.
- **Distribution amount for the spindle** For an analog spindle control circuit:
Upon specifying a speed command requiring more than 4096 pulses, in detection units, within 8 ms, a P/S alarm (No.202) is issued because the result of such an operation is unpredictable.

For a serial spindle:
Upon specifying a speed command requiring more than 32767 pulses, in detection units, within 8 ms, a P/S alarm (No.202) is issued because the result of such an operation is unpredictable.
- **F command** If a value exceeding the upper limit of cutting feedrate is specified, P/S alarm (No. 011) is issued.
- **Unit of F command**

	Metric input	Inch input	Remarks
G94	1 mm/min	0.01 inch/min	Decimal point programming allowed
G95	0.01 mm/rev	0.0001 inch/rev	Decimal point programming allowed
- **M29** If an S command and axis movement are specified between M29 and G84, P/S alarm (No. 203) is issued. If M29 is specified in a tapping cycle, P/S alarm (No. 204) is issued.
- **R** Specify R in a block that performs drilling. If R is specified in a non-drilling block, it is not stored as modal data.
- **Cancel** Do not specify a G code of the 01 group (G00 to G03 or G60 (when the MDL bit (bit 0 of parameter 5431) is set to 1)) and G84 in a single block. Otherwise, G84 will be canceled.
- **Tool offset** In the canned cycle mode, tool offsets are ignored.

Examples**Z-axis feedrate 1000 mm/min****Spindle speed 1000 rpm****Thread lead 1.0 mm****<Programming of feed per minute>****G94 ;** Specify a feed-per-minute command.**G00 X120.0 Y100.0 ;** Positioning**M29 S1000 ;** Rigid mode specification**G84 Z-100.0 R-20.0 F1000 ;** Rigid tapping**<Programming of feed per revolution>****G95 ;** Specify a feed-per-revolution command.**G00 X120.0 Y100.0 ;** Positioning**M29 S1000 ;** Rigid mode specification**G84 Z-100.0 R-20.0 F1.0 ;** Rigid tapping

13.2.2 Left-handed Rigid Tapping Cycle (G74)

When the spindle motor is controlled in rigid mode as if it were a servo motor, tapping cycles can be sped up.

Format

G74 X_ Y_ Z_ R_ P_ F_ K_ ;

X_ Y_ : Hole position data

Z_ : The distance from point R to the bottom of the hole and the position of the bottom of the hole

R_ : The distance from the initial level to point R level

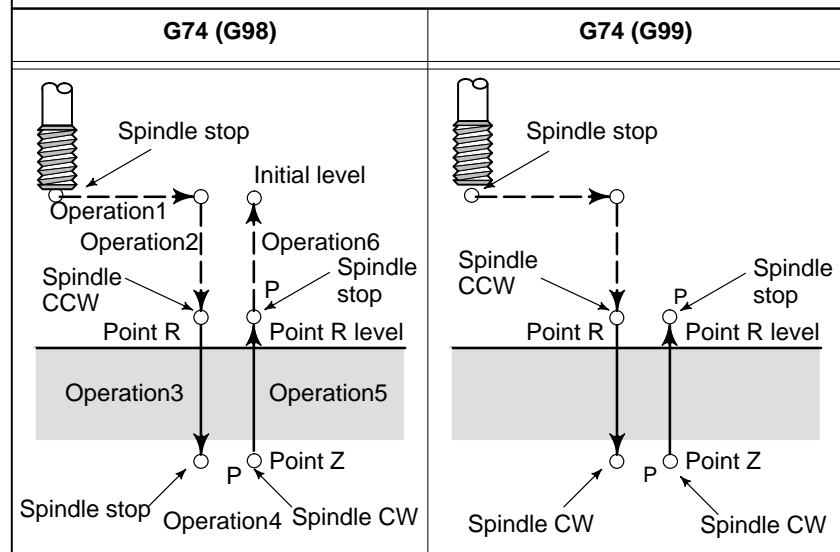
P_ : Dwell time at the bottom of the hole and at point R when return is made.

F_ : Cutting feedrate

K_ : Number of repeats (Only for necessity of repeat)

G84.3 X_ Y_ Z_ R_ P_ F_ L_ ; (FS15 format)

L_ : Number of repeats (Only for necessity of repeat)



Explanations

After positioning along the X- and Y-axes, rapid traverse is performed to point R.

Tapping is performed from point R to point Z. When tapping is completed, the spindle is stopped and a dwell is performed. The spindle is then rotated in the normal direction, the tool is retracted to point R, then the spindle is stopped. Rapid traverse to initial level is then performed. While tapping is being performed, the feedrate override and spindle override are assumed to be 100%.

However, the speed for extraction (operation 5) can be overridden by up to 200% depending on the setting at bit 4 (DOV) of parameter 5200 and parameter 5211.

• Rigid mode

Rigid mode can be specified using any of the following methods:

- **Specify M29 S***** before a tapping command.**
- **Specify M29 S***** in a block which contains a tapping command.**
- **Specify G84 for rigid tapping. (parameter G84 No. 5200#0 set to 1).**

- **Thread lead** In feed-per-minute mode, the thread lead is obtained from the expression, feedrate \times spindle speed. In feed-per-revolution mode, the thread lead equals the feedrate.
- **Tool length compensation** If a tool length offset (G43, G44, or G49) is specified in the canned cycle, the offset is applied at the time of positioning to point R.
- **FS15-format command** Rigid tapping can be performed using FS15-format commands. Rigid tapping (Including data transfer to and from the PMC) is performed according to the sequence for the FS16/18.

Limitations

- **Axis switching** Before the drilling axis can be changed, the canned cycle must be canceled. If the drilling axis is changed in rigid mode, P/S alarm (No. 206) is issued.
- **S command** Specifying a rotation speed exceeding the maximum speed for the gear used causes P/S alarm (No. 200).
- **Distribution amount for the spindle**

For an analog spindle control circuit:
Upon specifying a speed command requiring more than 4096 pulses, in detection units, within 8 ms, a P/S alarm (No.202) is issued because the result of such an operation is unpredictable.

For a serial spindle:
Upon specifying a speed command requiring more than 32767 pulses, in detection units, within 8 ms, a P/S alarm (No.202) is issued because the result of such an operation is unpredictable.
- **F command** Specifying a value that exceeds the upper limit of cutting feedrate causes P/S alarm (No. 011).
- **Unit of F command**

	Metric input	Inch input	Remarks
G94	1 mm/min	0.01 inch/min	Decimal point programming allowed
G95	0.01 mm/rev	0.0001 inch/rev	Decimal point programming allowed
- **M29** Specifying an S command or axis movement between M29 and G84 causes P/S alarm (No. 203).
Then, specifying M29 in the tapping cycle causes P/S alarm (No. 204).
- **R** Specify R in a block that performs drilling. If R is specified in a non-drilling block, it is not stored as modal data.
- **Cancel** Do not specify a G code of the 01 group (G00 to G03 or G60 (when the MDL bit (bit 0 of parameter 5431) is set to 1)) and G74 in a single block. Otherwise, G74 will be canceled.
- **Tool offset** In the canned cycle mode, tool offsets are ignored.

Examples**Z-axis feedrate 1000 mm/min****Spindle speed 1000 rpm****Thread lead 1.0 mm****<Programming for feed per minute>****G94 ;** Specify a feed-per-minute command.**G00 X120.0 Y100.0 ;** Positioning**M29 S1000 ;** Rigid mode specification**G84 Z-100.0 R-20.0 F1000 ;** Rigid tapping**<Programming for feed per revolution>****G95 ;** Specify a feed-per-revolution command.**G00 X120.0 Y100.0 ;** Positioning**M29 S1000 ;** Rigid mode specification**G74 Z-100.0 R-20.0 F1.0 ;** Rigid tapping

13.2.3 Peck Rigid Tapping Cycle (G84 or G74)

Tapping a deep hole in rigid tapping mode may be difficult due to chips sticking to the tool or increased cutting resistance. In such cases, the peck rigid tapping cycle is useful.

In this cycle, cutting is performed several times until the bottom of the hole is reached. Two peck tapping cycles are available: High-speed peck tapping cycle and standard peck tapping cycle. These cycles are selected using the PCP bit (bit 5) of parameter 5200.

Format

G84 (or G74) X_ Y_ Z_ R_ P_ Q_ F_ K_ ;

- X_ Y_ : Hole position data
- Z_ : The distance from point R to the bottom of the hole and the position of the bottom of the hole
- R_ : The distance from the initial level to point R level
- P_ : Dwell time at the bottom of the hole and at point R when a return is made
- Q_ : Depth of cut for each cutting feed
- F_ : The cutting feedrate
- K_ : Number of repeats

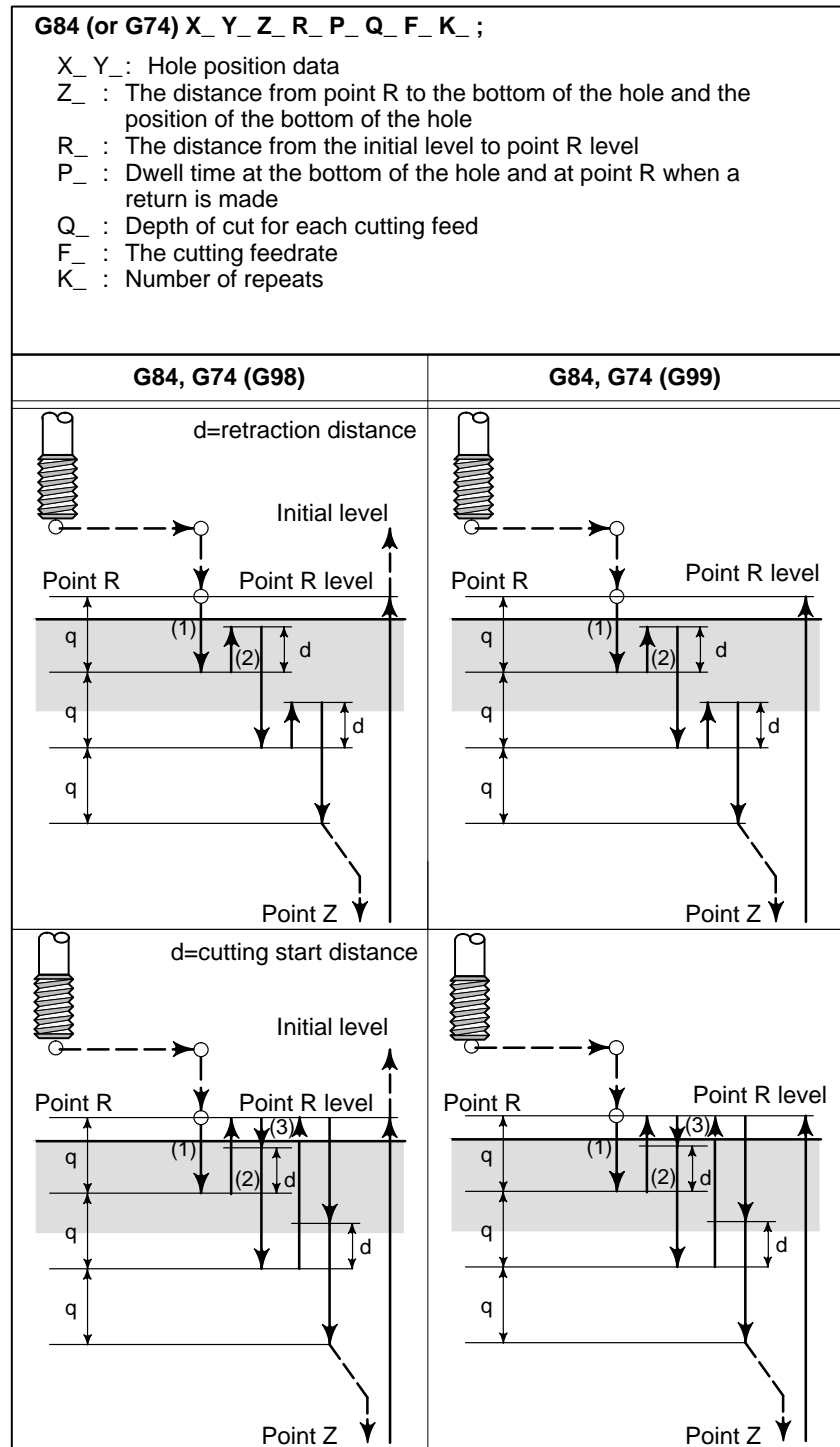
High-speed peck tapping cycle
(Parameter PCP(No.5200#5=0))

- (1) The tool operates at a normal cutting feedrate. The normal time constant is used.
- (2) Retraction can be overridden. The retraction time constant is used.

Peck tapping cycle
(Parameter PCP(No.5200#5=1))

- (1) The tool operates at a normal cutting feedrate. The normal time constant is used.
- (2) Retraction can be overridden. The retraction time constant is used.
- (3) Retraction can be overridden. The normal time constant is used.

During a rigid tapping cycle, in-position check is performed at the end of each operation of (1) and (2) in the peck tapping cycle.



Explanations

- **High-speed peck tapping cycle**

After positioning along the X- and Y-axes, rapid traverse is performed to point R. From point R, cutting is performed with depth Q (depth of cut for each cutting feed), then the tool is retracted by distance d. The DOV bit (bit 4) of parameter 5200 specifies whether retraction can be overridden or not. When point Z has been reached, the spindle is stopped, then rotated in the reverse direction for retraction.

Set the retraction distance, d, in parameter 5213.

- **Peck tapping cycle**

After positioning along the X- and Y-axes, rapid traverse is performed to point R level. From point R, cutting is performed with depth Q (depth of cut for each cutting feed), then a return is performed to point R. The DOV bit (bit 4) of parameter 5200 specifies whether the retraction can be overridden or not. The moving of cutting feedrate F is performed from point R to a position distance d from the end point of the last cutting, which is where cutting is restarted. For this moving of cutting feedrate F, the specification of the DOV bit (bit 4) of parameter 5200 is also valid. When point Z has been reached, the spindle is stopped, then rotated in the reverse direction for retraction.

Set d (distance to the point at which cutting is started) in parameter 5213.

Limitations

- **Axis switching**

Before the drilling axis can be changed, the canned cycle must be canceled. If the drilling axis is changed in rigid mode, P/S alarm (No. 206) is issued.

- **S command**

Specifying a rotation speed exceeding the maximum speed for the gear used causes P/S alarm (No. 200).

- **Distribution amount for the spindle**

For an analog spindle control circuit:

Upon specifying a speed command requiring more than 4096 pulses, in detection units, within 8 ms, a P/S alarm (No.202) is issued because the result of such an operation is unpredictable.

For a serial spindle:

Upon specifying a speed command requiring more than 32767 pulses, in detection units, within 8 ms, a P/S alarm (No.202) is issued because the result of such an operation is unpredictable.

- **F command**

Specifying a value that exceeds the upper limit of cutting feedrate causes alarm (No. 011).

- **Unit of F**

	Metric input	Inch input	Remarks
G94	1 mm/min	0.01 inch/min	Decimal point programming allowed
G95	0.01 mm/rev	0.0001 inch/rev	Decimal point programming allowed

- **M29**

Specifying an S command or axis movement between M29 and G84 causes P/S alarm (No. 203).

Then, specifying M29 in the tapping cycle causes P/S alarm (No. 204).

- **Q/R**

Specify Q and R in a block that performs drilling. If they are specified in a block that does not perform drilling, they are not stored as modal data. When Q0 is specified, the peck rigid tapping cycle is not performed.

- **Cancel** Do not specify a group 01 G code (G00 to G03) and G73 in the same block. If they are specified together, G73 is canceled.
 - **Tool offset** In the canned cycle mode, tool offsets are ignored.
-

13.2.4 Canned Cycle Cancel (G80)

The rigid tapping canned cycle is canceled. For how to cancel this cycle, see II-13.1.14.

13.3 CANNED GRINDING CYCLE (FOR GRINDING MACHINE)

Canned grinding cycles make it easier for the programmer to create programs that include grinding. With a canned grinding cycle, repetitive operation peculiar to grinding can be specified in a single block with a G function; without canned grinding cycles, normally more than one block is required. In addition, the use of canned grinding cycles shortens the program to save memory. The following four canned grinding cycles are available:

- Plunge grinding cycle (G75)
- Direct constant–dimension plunge grinding cycle (G77)
- Continuous–feed surface grinding cycle (G78)
- Intermittent–feed surface grinding cycle (G79)

13.3.1 Plunge Grinding Cycle (G75)

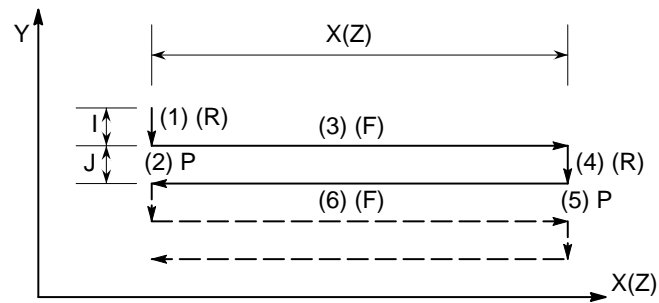
A plunge grinding cycle is performed.

Format

G75 I_ J_ K_ X(Z)_ R_ F_ P_ L_ ;

I_ : Depth-of-cut 1 (A sign in the command specifies the direction of cutting.)
 J_ : Depth-of-cut 2 (A sign in the command specifies the direction of cutting.)
 K_ : Total depth of cut (A sign in the command specifies the direction of cutting.)
 X(Z)_ : Range of grinding (A sign in the command specifies the direction of grinding.)
 R_ : Feedrate for I and J
 F_ : Feedrate for X (Z)
 P_ : Dwell time
 L_ : Grinding-wheel wear compensation (Only for continuous dressing)

G75



Explanations

The plunge grinding cycle consists of six operation sequences. Operations (1) to (6) are repeated until the depth reaches the total depth of cut specified at address K. In the single block stop mode, operations (1) to (6) are performed every cycle start.

- **Grinding wheel cutting** (1) Cutting is performed along the Y-axis in cutting feed mode for the amount specified by I (depth of cut 1). The feedrate is specified by R.
- **Dwell** (2) Dwell is performed for the time specified by P.
- **Grinding** (3) Cutting feed is performed for the amount specified by X (or Z). The feedrate is specified by F.
- **Grinding wheel cutting** (4) Cutting is performed along the Y-axis in cutting feed mode for the amount specified by J (depth of cut 2). The feedrate is specified by R.
- **Dwell** (5) Dwell is performed for the time specified by P.
- **Grinding (return direction)** (6) Feeding is performed in the reverse direction for the amount specified by X (or Z) at a feedrate specified by F.

Limitations

- X(Z), I, J, K

X, (Z), I, J, and K must all be specified in incremental mode.

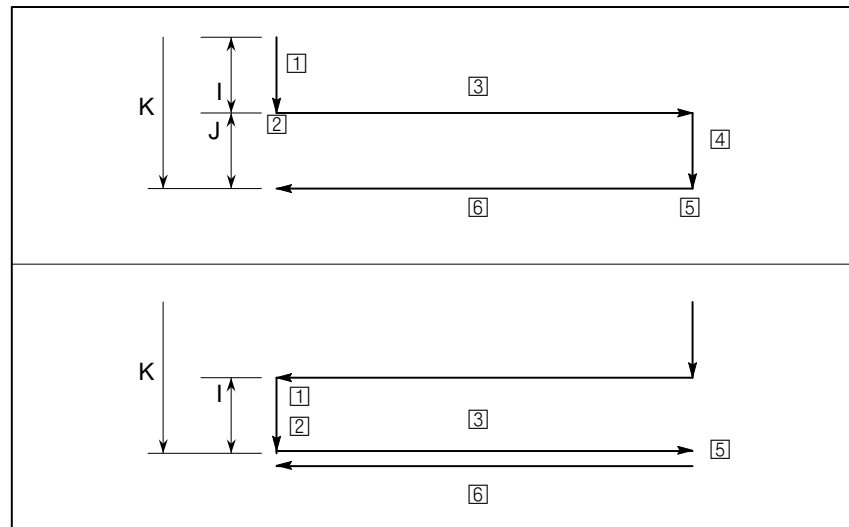
- Clear

I, J, X, and Z in canned cycles are modal data common to G75, G77, G78, and G79. They remain valid until new data is specified. They are cleared when a group 00 G code other than G04 or a group 01 G code other than G75, G77, G78, and G79 is specified.

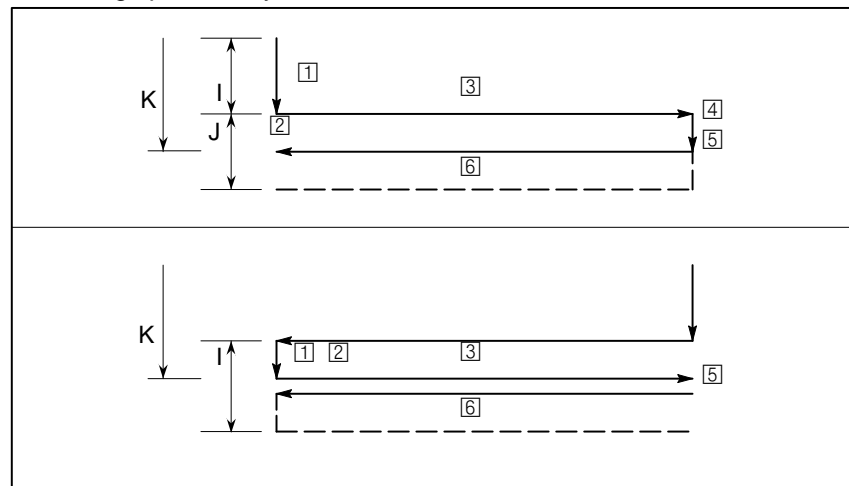
- **Operation performed when the total depth of cut is reached**

When the total depth of cut is reached during cutting using I or J, the subsequent operation sequences (up to [6]) are executed, then the cycle terminates. In this case, no further cutting is performed after the total depth of cut is reached.

- Chart of operation in which the total depth of cut is reached by cutting specified by I and J:



- Chart of operation in which the total depth of cut is reached during cutting specified by I and J:



13.3.2 Direct Constant-dimension Plunge Grinding Cycle (G77)

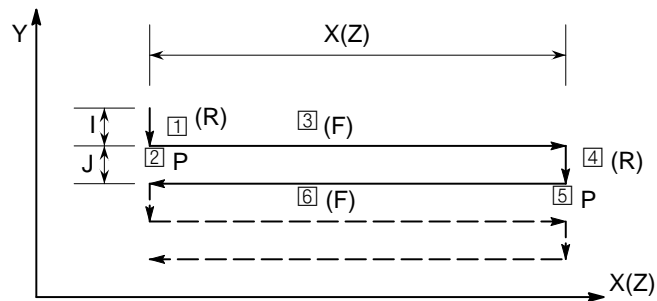
A direct constant-dimension plunge grinding cycle is performed.

Format

G77 I_ J_ K_ X(Z)_ R_ F_ P_ L_ ;

I_ : Depth-of-cut 1 (A sign in the command specifies the direction of cutting.)
 J_ : Depth-of-cut 2 (A sign in the command specifies the direction of cutting.)
 K_ : Total depth of cut (A sign in the command specifies the direction of cutting.)
 X(Z)_ : Range of grinding (A sign in the command specifies the direction of grinding.)
 R_ : Feedrate for I and J
 F_ : Feedrate for X (Z)
 P_ : Dwell time
 L_ : Grinding-wheel wear compensation (Only for continuous dressing)

G77



Explanations

The constant-dimension plunge grinding cycle consists of six operation sequences. Operations ① to ⑥ are repeated until the depth reaches the total depth of cut specified at address K.

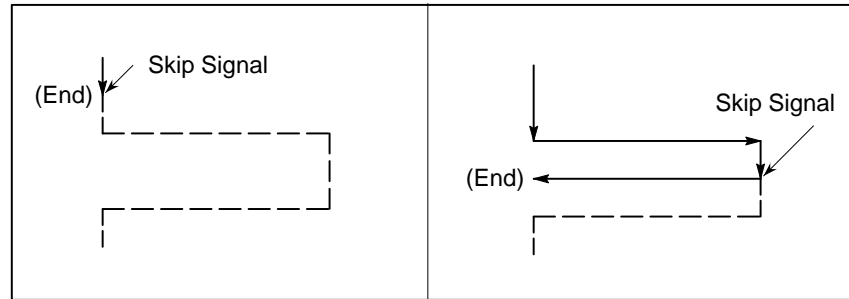
- Grinding wheel cutting
- Dwell
- Grinding
- Grinding wheel cutting
- Dwell
- Grinding (return direction)

- ① Cutting is performed along the Y-axis in cutting feed mode for the amount specified by I (depth of cut 1). The feedrate is specified by R.
- ② Dwell is performed for the time specified by P.
- ③ Cutting feed is performed for the amount specified by X (or Z). The feedrate is specified by F.
- ④ Cutting is performed along the Y-axis in cutting feed mode for the amount specified by J (depth of cut 2). The feedrate is specified by R.
- ⑤ Dwell is performed for the time specified by P.
- ⑥ Feeding is performed in the reverse direction for the amount specified by X (or Z) at a feedrate specified by F.

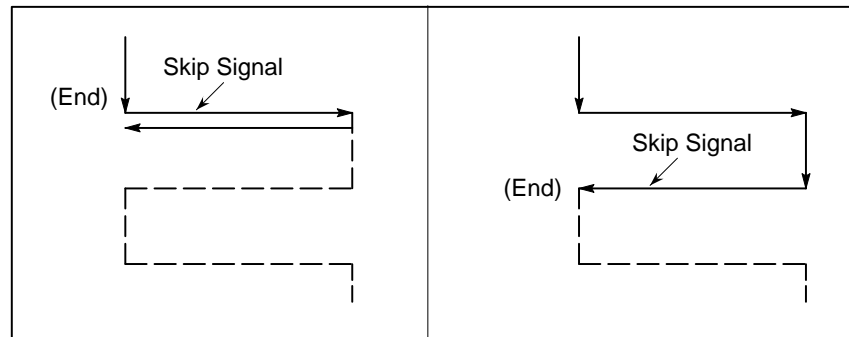
• **Skip signal**

When the cycle is performed using G77, a skip signal can be input to terminate the cycle. When a skip signal is input, the current operation sequence is interrupted or completed, then the cycle is terminated. The following shows how the system operates when the skip signal is input during each operation sequence.

- When the skip signal is input during operation sequence 1 or 4 (cutting feed specified by I or J), cutting is stopped immediately and the tool returns to the X (Z) coordinate at which the cycle started.



- When the skip signal is input during operation sequence 2 or 5 (dwell), dwell is stopped immediately and the tool returns to the X (Z) coordinate at which the cycle started.
- When the skip signal is input during operation sequence 3 or 6 (movement), the tool returns to the X (Z) coordinate at which the cycle started after the movement specified by X (Z) is completed.



Limitations

- **X(Z), I, J, K**
- **Clear**

X, (Z), I, J, and K must all be specified in incremental mode.

I, J, X, and Z in canned cycles are modal data common to G75, G77, G78, and G79. They remain valid until new data is specified. They are cleared when a group 00 G code other than G04 or a group 01 G code other than G75, G77, G78, and G79 is specified.

13.3.3 Continuous-feed Surface Grinding Cycle (G78)

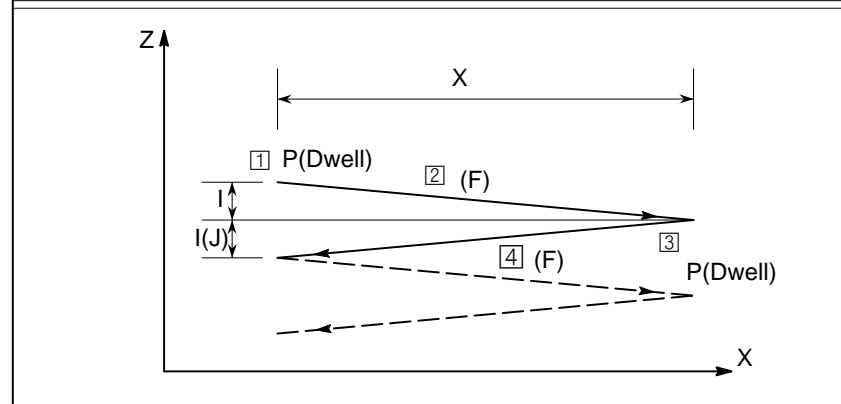
A continuous-feed surface grinding cycle is performed.

Format

G78 I_ (J_) K_ X_ F_ P_ L_ ;

- I_ : Depth-of-cut 1 (A sign in the command specifies the direction of cutting.)
- J_ : Depth-of-cut 2 (A sign in the command specifies the direction of cutting.)
- K_ : Total depth of cut (A sign in the command specifies the direction of cutting.)
- X(Z)_ : Range of grinding (A sign in the command specifies the direction of grinding.)
- R_ : Feedrate for I and J
- F_ : Feed rate
- P_ : Dwell time
- L_ : Grinding-wheel wear compensation (Only for continuous dressing)

G78



Explanations

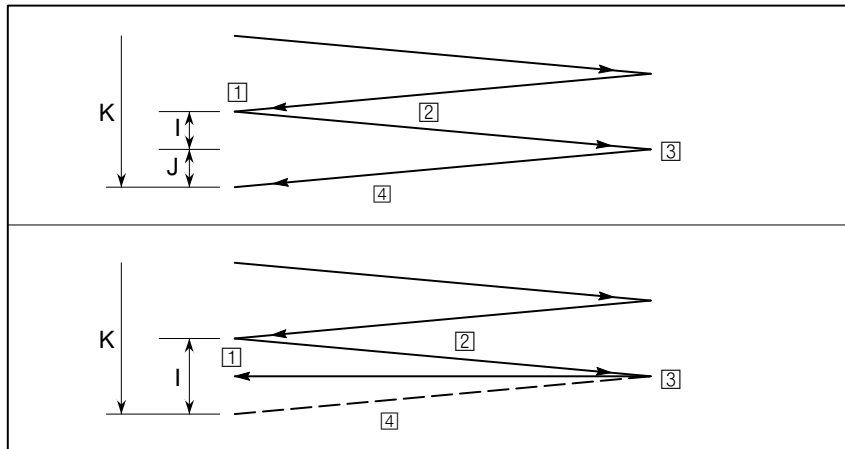
The continuous-feed surface grinding cycle consists of four operation sequences. Operations ① to ④ are repeated until the depth reaches the total depth of cut specified in address K. In the single block stop mode, operations ① to ④ are performed every cycle start.

- ① Dwell
- ② Grinding
- ③ Dwell
- ④ Grinding (in reverse direction)

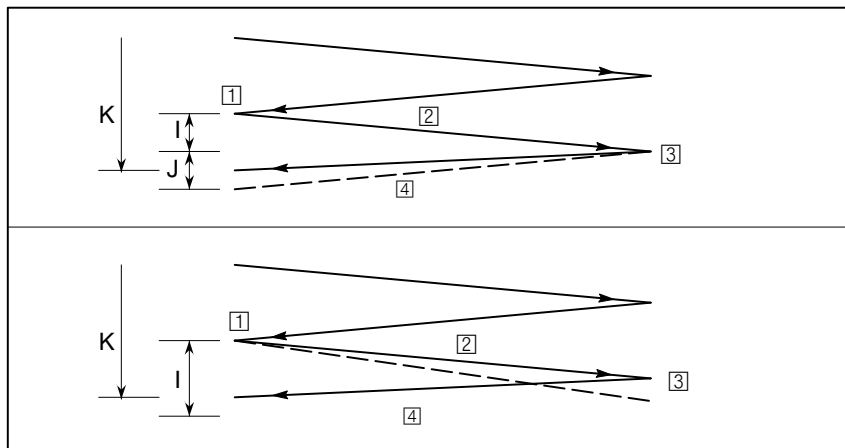
Restrictions

- **J** When J is omitted, it is assumed to be 1. J is valid only in the block where it is specified.
- **I, J, K, X** X, (Z), I, J, and K must all be specified in incremental mode.
- **Clear** I, J, X, and Z in canned cycles are modal data common to G75, G77, G78, and G79. They remain valid until new data is specified. They are cleared when a group 00 G code other than G04 or a group 01 G code other than G75, G77, G78, and G79 is specified.
- **Operation performed when the total depth of cut is reached** When the total depth of cut is reached during cutting using I or J, the subsequent operation sequences (up to [4]) are executed, then the cycle terminates. In this case, no further cutting is performed after the total depth of cut is reached.

- Chart of operation in which the total depth of cut is reached by cutting specified by I and J:



- Chart of operation in which the total depth of cut is reached during cutting specified by I and J:



13.3.4 Intermittent-feed Surface Grinding Cycle (G79)

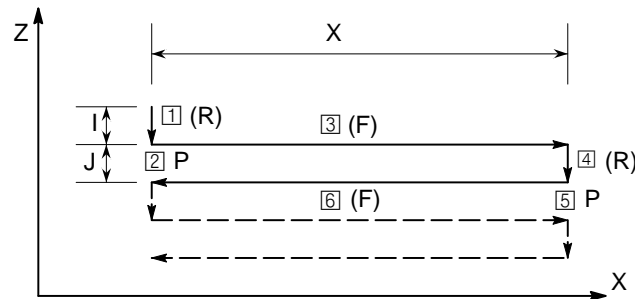
An intermittent-feed surface grinding cycle is performed.

Format

G79 I_ J_ K_ X_ R_ F_ P_ L_ ;

I_ : Depth-of-cut 1 (A sign in the command specifies the direction of cutting.)
 J_ : Depth-of-cut 2 (A sign in the command specifies the direction of cutting.)
 K_ : Total depth of cut (A sign in the command specifies the direction of cutting.)
 X(Z)_ : Range of grinding (A sign in the command specifies the direction of grinding.)
 R_ : Feedrate for I and J
 F_ : Feedrate for X (Z)
 P_ : Dwell time
 L_ : Grinding-wheel wear compensation (Only for continuous dressing)

G79



Explanations

The intermittent-feed surface grinding cycle consists of six operation sequences. Operations ① to ⑥ are repeated until the depth reaches the total depth of cut specified at address K. In the single block stop mode, operations ① to ⑥ are performed every cycle start.

- Grinding wheel cutting
- Dwell
- Grinding
- Grinding wheel cutting
- Dwell
- Grinding (return direction)

- ① Cutting is performed along the Z-axis in cutting feed mode for the amount specified by I (depth of cut 1). The feedrate is specified by R.
- ② Dwell is performed for the time specified by P.
- ③ Cutting feed is performed for the amount specified by X (or Z). The feedrate is specified by F.
- ④ Cutting is performed along the Z-axis in cutting feed mode for the amount specified by J (depth of cut 2). The feedrate is specified by R.
- ⑤ Dwell is performed for the time specified by P.
- ⑥ Feeding is performed in the reverse direction for the amount specified by X at a feedrate specified by F.

Restrictions

- **X, I, J, K** X, (Z), I, J, and K must all be specified in incremental mode.
- **Clear** I, J, X, and Z in canned cycles are modal data common to G75, G77, G78, and G79. They remain valid until new data is specified. They are cleared when a group 00 G code other than G04 or a group 01 G code other than G75, G77, G78, and G79 is specified.

13.4 GRINDING- WHEEL WEAR COMPENSATION BY CONTINUOUS DRESSING (FOR GRINDING MACHINE)

This function enables continuous dressing.

When G75, G77, G78, or G79 is specified, grinding wheel cutting and dresser cutting are compensated continuously according to the amount of continuous dressing during grinding.

Explanations

- **Specification**

Specify an offset number (grinding-wheel wear compensation number) at address L in the block containing G75. The compensation amount set in the offset memory area corresponding to the specified number is used as the amount of dressing.

Up to 400 offset numbers (L1 to L400) can be specified. Compensation amounts must be set beforehand in offset memory corresponding to offset numbers from the CRT/MDI panel.

When L is omitted or L0 is specified in a surface grinding canned cycle block, compensation is not performed.

- **Compensation**

Compensation is performed for every grinding operation (every movement along the X-axis) in the operation sequences of a canned grinding cycle. While the tool moves along the X-axis, compensation is performed along the Y-axis (grinding wheel cutting) and the V-axis (dresser cutting) for simultaneous three-axis interpolation.

The travel distance (compensation amount) along the Y-axis is the same as specified dressing amount, and the travel distance along the V-axis is twice as long (diameter).

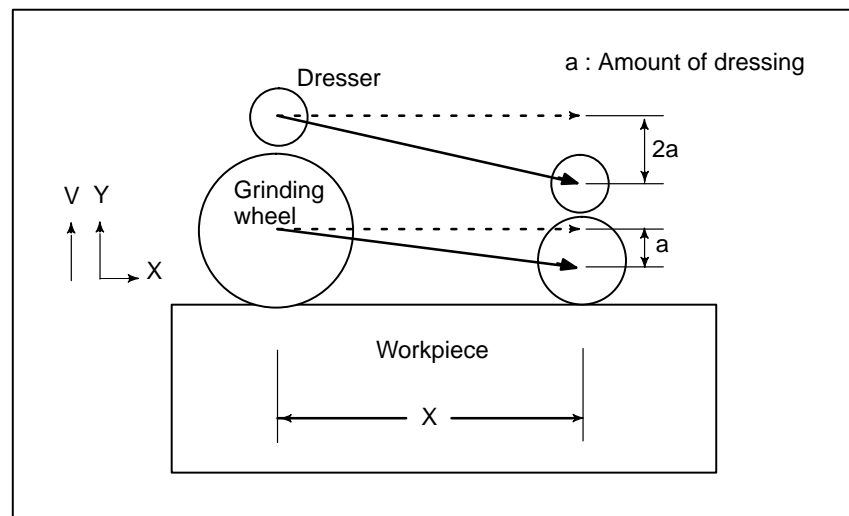
13.5 AUTOMATIC GRINDING WHEEL DIAMETER COMPENSATION AFTER DRESSING

13.5.1 Checking the Minimum Grinding Wheel Diameter (for grinding machine)

Compensation amounts set in offset memory can be modified by using the external tool compensation function or programming (by changing offsets using custom macro variables).

With these functions, the compensation amount for the diameter of the dressed grinding wheel can be changed.

If the compensation amount associated with the offset number specified in the H code is smaller than the minimum grinding wheel diameter specified in parameter 5030 when programmed compensation (using G43 or G44) is performed, a signal is output to the PMC.



13.6 IN-FEED GRINDING ALONG THE Y AND Z AXES AT THE END OF TABLE SWING (FOR GRINDING MACHINE)

Format

```
G161 R_ ;
  profile program
G160 ;
```

Explanations

- **G161 R_**
- **Profile program**
- **G160**

Specify the start of an operation mode and profile program. Also specify the depth of cut in R.

Program a workpiece figure in the Y-Z plane using linear interpolation (G01) and/or circular interpolation (G02 or G03). One or more blocks can be specified.

Cancel the operation mode (end of the profile program).

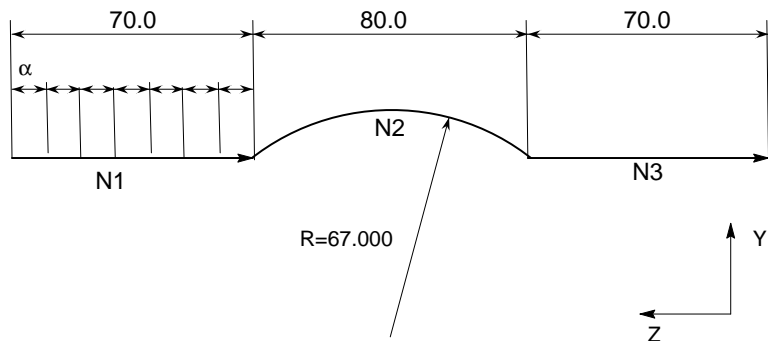
Restrictions

- **Profile program**

Do not specify codes other than G01, G02, and G03 within the profile program.

Examples

```
O0001 ;
:
N0 G161 R10.0 ;
N1 G91 G01 Z-70.0 F100 ;
N2 G19 G02 Z-80.0 R67.0 ;
N3 G01 Z-70.0 ;
N4 G160 ;
:
```



In the above program, every time the in-feed cutting start signal is input, the tool is moved by 10.000 along the machining profile shown above.

α = Travel distance for each in-feed control cutting start signal input
The feedrate is programmed with an F code.

13.7 OPTIONAL ANGLE CHAMFERING AND CORNER ROUNDING

Chamfering and corner rounding blocks can be inserted automatically between the following:

- Between linear interpolation and linear interpolation blocks
- Between linear interpolation and circular interpolation blocks
- Between circular interpolation and linear interpolation blocks
- Between circular interpolation and circular interpolation blocks

Format

, C_	Chamfering
, R_	Corner R

Explanations

When the above specification is added to the end of a block that specifies linear interpolation (G01) or circular interpolation (G02 or G03), a chamfering or corner rounding block is inserted.

Blocks specifying chamfering and corner rounding can be specified consecutively.

• Chamfering

After C, specify the distance from the virtual corner point to the start and end points. The virtual corner point is the corner point that would exist if chamfering were not performed.

```
(1) G91 G01 X100.0 ,C10.0
;
(2) X100.0 Y100.0 ;
```

• Corner R

After R, specify the radius for corner rounding.

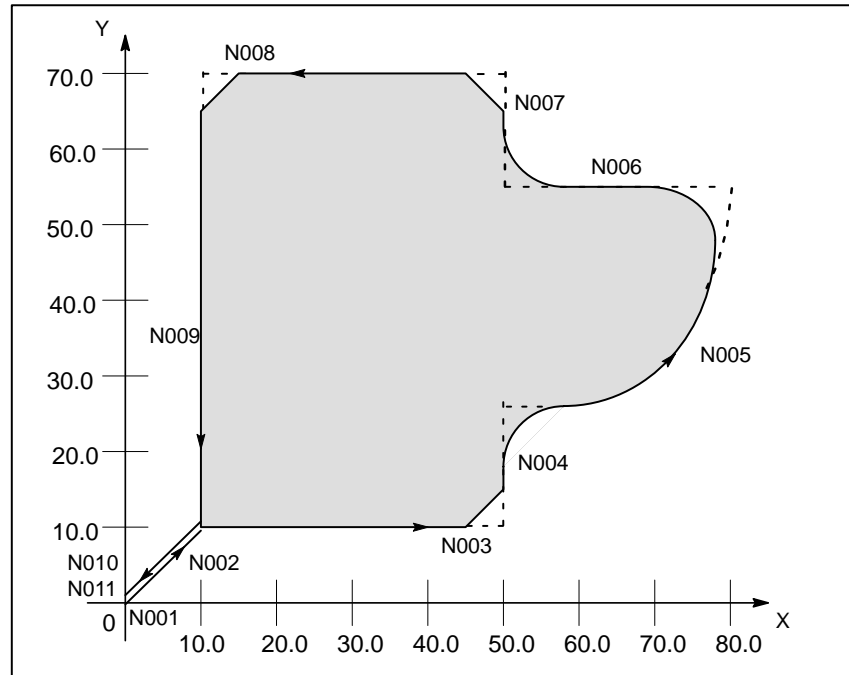
```
(1) G91 G01 X100.0 ,R10.0
;
(2) X100.0 Y100.0 ;
```

Examples

```

N001 G92 G90 X0 Y0 ;
N002 G00 X10.0 Y10.0 ;
N003 G01 X50.0 F10.0 ,C5.0 ;
N004 Y25.0 ,R8.0 ;
N005 G03 X80.0 Y50.0 R30.0 ,R8.0 ;
N006 G01 X50.0 ,R8.0 ;
N007 Y70.0 ,C5.0 ;
N008 X10.0 ,C5.0 ;
N009 Y10.0 ;
N010 G00 X0 Y0 ;
N011 M0 ;

```



Restrictions

- **Plane selection**

Chamfering and corner rounding can be performed only in the plane specified by plane selection (G17, G18, or G19). These functions cannot be performed for parallel axes.

- **Next block**

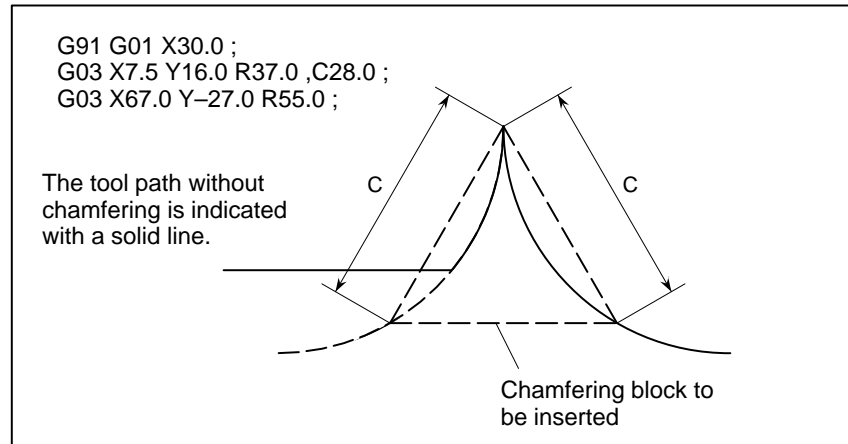
A block specifying chamfering or corner rounding must be followed by a block that specifies a move command using linear interpolation (G01) or circular interpolation (G02 or G03). If the next block does not contain these specifications, P/S alarm No. 052 is issued.

- **Plane switching**

A chamfering or corner rounding block can be inserted only for move commands which are performed in the same plane. In a block that comes immediately after plane switching (G17, G18, or G19 is specified), neither chamfering nor corner rounding can be specified.

- **Exceeding the move range**

If the inserted chamfering or corner rounding block causes the tool to go beyond the original interpolation move range, P/S alarm No.055 is issued.



- **Coordinate system**

In a block that comes immediately after the coordinate system is changed (G92, or G52 to G59) or a return to the reference position (G28 to G30) is specified, neither chamfering nor corner rounding can be specified.

- **Travel distance 0**

When two linear interpolation operations are performed, the chamfering or corner rounding block is regarded as having a travel distance of zero if the angle between the two straight lines is within $+1^\circ$. When linear interpolation and circular interpolation operations are performed, the corner rounding block is regarded as having a travel distance of zero if the angle between the straight line and the tangent to the arc at the intersection is within $+1^\circ$. When two circular interpolation operations are performed, the corner rounding block is regarded as having a travel distance of zero if the angle between the tangents to the arcs at the intersection is within $+1^\circ$.

- **Unavailable G codes**

The following G codes cannot be used in a block that specifies chamfering or corner rounding. They also cannot be used between chamfering and corner rounding blocks that define a continuous figure.

- G codes of group 00 (except G04)
- G68 of group 16

- **Threading**

Corner rounding cannot be specified in a threading block.

13.8 EXTERNAL MOTION FUNCTION (G81)

Upon completion of positioning in each block in the program, an external operation function signal can be output to allow the machine to perform specific operation.

Concerning this operation, refer to the manual supplied by the machine tool builder.

Format

G81 IP_ ; (IP_ Axis move command)
--

Explanations

Every time positioning for the IP_ move command is completed, the CNC sends a external operation function signal to the machine. An external operation signal is output for each positioning operation until canceled by G80 or a group 01 G code.

Restrictions

- **A block without X or Y axis**
- **Relationship with canned cycle G81**

No external operation signals are output during execution of a block that contains neither X nor Y.

G81 can also be used for a drilling canned cycle (II-13.1.4). Whether G81 is to be used for an external motion function or for a drilling canned cycle is psecified with EXC, bit 1 of parameter No.5101.

13.9 FIGURE COPY (G72.1, G72.2)

Machining can be repeated after moving or rotating the figure using a subprogram.

Format

- Rotational copy

Xp–Yp plane (specified by G17) : G72.1 P_ L_ Xp_ Yp_ R_ ;
Zp–Xp plane (specified by G18) : G72.1 P_ L_ Zp_ Xp_ R_ ;
Yp–Zp plane (specified by G19) : G72.1 P_ L_ Yp_ Zp_ R_ ;

P :Subprogram number
 L :Number of times the operation is repeated
 Xp :Center of rotation on the Xp axis
 (Xp : X–axis or an axis parallel to the X–axis)
 Yp :Center of rotation on the Yp axis
 (Yp: Y–axis or an axis parallel to the Y–axis)
 Zp :Center of rotation on the Zp axis
 (Zp: Z–axis or an axis parallel to the Z–axis)
 R :Angular displacement
 (A positive value indicates a counterclockwise angular displacement.
 Specify an incremental value.)

Specify a plane selection command (G17, G18, or G19) to select the plane on which the rotational copy is made.

- Linear copy

Xp–Yp plane (specified by G17) : G72.2 P_ L_ I_ J_ ;
Zp–Xp plane (specified by G18) : G72.2 P_ L_ K_ I_ ;
Yp–Zp plane (specified by G19) : G72.2 P_ L_ J_ K_ ;

P :Subprogram number
 L :Number of times the operation is repeated
 I :Shift along the Xp axis
 J :Shift along the Yp axis
 K :Shift along the Zp axis

Specify a plane selection command (G17, G18, or G19) to select the plane on which the linear copy is made.

Explanations

- First block of the subprogram

Always specify a move command in the first block of a subprogram that performs a rotational or linear copy. If the first block contains only the program number such as O1234; and does not have a move command, movement may stop at the start point of the figure made by the n–th (n = 1, 2, 3, ...) copying.

Specify the first move command in the absolute mode.

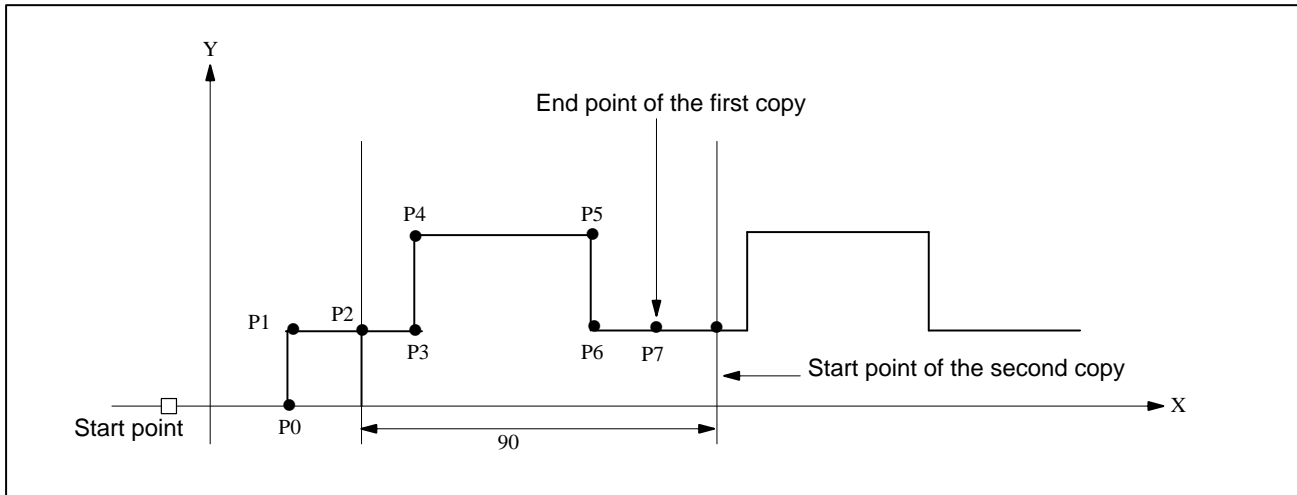
(Example of an incorrect program)

```
O1234 ;
G00 G90 X100.0 Y200.0 ;
.... ;
.... ;
M99 ;
```

(Example of a correct program)

```
O1000 G00 G90 X100.0 Y200.0 ;
... ;
... ;
M99 ;
```

- **Combination of rotational and linear copying**
The linear copy command can be specified in a subprogram for a rotational copy. Also, the rotational copy command can be specified in a subprogram for a linear copy.
- **Subprogram calling**
In a subprogram for rotational or linear copying, M98 for calling another subprogram or G65 for calling a macro can be specified.
- **Specifying the center of rotation**
The center of rotation specified with G72.1 is processed as an absolute position even in the incremental mode.
- **Specifying address**
In a block with G72.1, addresses other than P, L, Xp, Yp, Zp, or R are ignored. The subprogram number (P), coordinates of the center of rotation (Xp, Yp, Zp), and angular displacement (R) must be specified. In a block with G72.2, addresses other than P, L, I, J, or K are ignored. The subprogram number (P) and shift (I, J, K) must be specified.
- **Address P**
If the subprogram number specified with P is not found, P/S alarm No. 078 occurs. If P is not specified, P/S alarm No. 076 occurs.
- **Address L**
If L is omitted, the repetition count is assumed to be 1 and the subprogram is called only once.
- **Increment in angular displacement or shift**
In a block with G72.1, an increment in angular displacement is specified with address R. The angular displacement of the figure made by the n-th rotation is calculated as follows : $R \times (n - 1)$.
In a block with G72.2, an increment in shift is specified with addresses I, J, and K. The shift of the figure made by the n-th movement is calculated as follows : (Programmed shift) $\times (n - 1)$.
- **Nesting level of a subprogram**
If a subprogram is called by G72.1 or G72.2, the nesting level is increased by one in the same manner as when M98 is specified.
- **Block end position**
The coordinates of a figure moved rotationally or linearly (block end position) can be read from #5001 and subsequent system variables of the custom macro of rotational or linear copy.
- **Disagreement between end point and start point**
If the end point of the figure made by the n-th copy does not agree with the start point of the figure to be made by the next (n + 1) copy, the figure is moved from the end point to the start point, then copying is started. (Generally, this disagreement occurs if an incorrect angular displacement or shift is specified.)



Main program

```
O1000 ;
N10 G92 X-20.0 Y0 ;
N20 G00 G90 X0 Y0 ;
N30 G01 G17 G41 X20. Y0 D01 F10 ;      (P0)
N40 Y20. ;                             (P1)
N50 X30. ;                               (P2)
N60 G72.2 P2000 L3 I90. J0 ;
```

Although a shift of 70 mm was required, I90.0 was specified instead of I70.0. Since an incorrect shift was specified, the end point of the figure made by the n-th copy disagrees with the start point of the figure to be made by the next (n + 1) copy.

Subprogram

```
O2000 G90 G01 X40. ;      (P3)
N100 Y40. ;              (P4)
N200 G01 X80. ;          (P5)
N300 G01 Y20. ;          (P6)
N400 X100. ;             (P7)
N500 M99;
```

Limitations

- **Specifying two or more commands to copy a figure**

G72.1 cannot be specified more than once in a subprogram for making a rotational copy (If this is attempted, P/S alarm No.160 will occur). G72.2 cannot be specified more than once in a subprogram for making a linear copy (If this is attempted, P/S alarm No. 161 will occur).

- **Commands that must not be specified**

Within a program that performs a rotational or linear copy, the following must not be specified:

- Command for changing the selected plane (G17 to G19)
- Command for specifying polar coordinates
- Reference position return command
- Coordinate system rotation, scaling, programmable mirror image

The command for rotational or linear copying can be specified after a command for coordinate system rotation, scaling, or programmable mirror image is executed.

- **Modes that must not be selected**
- **Unit system**
- **Single block**
- **Specifying cutter compensation and the workpiece coordinate system**

The figure cannot be copied during chamfering, corner rounding, or tool offset.

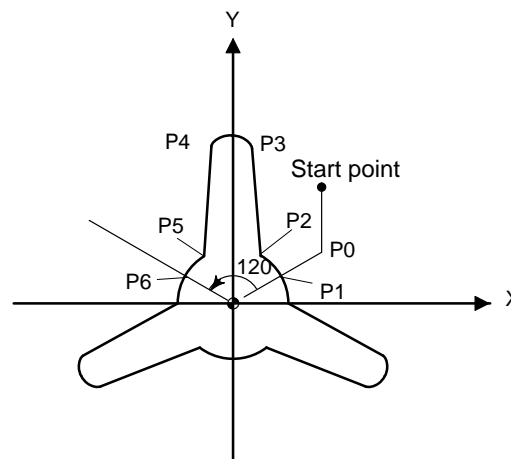
The two axes of the plane for copying a figure must have an identical unit system.

Single-block stops are not performed in a block with G721.1 or G72.2.

In a subprogram for copying a figure, the G code for cutter compensation B or C or compensation amount (H or D code) cannot be changed. G92 and G54 to G59 cannot be changed either. Those codes must be specified before figure copying is started.

Examples

- **Rotational copy**



Main program

```
O1000 ;
N10 G92 X40.0 Y50.0 ;
N20 G00 G90 X_ Y_ ; (P0)
N30 G01 G17 G41 X_ Y_ D01 F10 ; (P1)
N40 G72.1 P2000 L3 X0 Y0 R120.0 ;
N50 G40 G01 X_ Y_ I_ J_ ; (P0)
N60 G00 X40.0 Y50.0 ;
N70 M30 ;
```

Sub program

```
O2000 G03 X_ Y_ R30.0 ; (P2)
N100 G01 X_ Y_ ; (P3)
N200 G03 X_ Y_ R10.0 ; (P4)
N300 G01 X_ Y_ ; (P5)
N400 G03 X_ Y_ R30.0 ; (P6)
N500 M99 ;
```

● **Rotational copy (spot boring)**

Main program

```
O3000 ;
N10 G92 G17 X80.0 Y50.0 ; (P0)
N20 G72.1 P4000 L6 X0 Y0 R60.0 ;
N30 G80 G00 X80.0 Y50.0 ; (P0)
N40 M30 ;
```

Subprogram

```
O4000 N100 G90 G81 X_ Y_ R_ Z_ F_ ; (P1)
N200 M99 ;
```


● **Combination of rotational copying and linear copying (bolt hole circle)**

Main program

```
O1000 ;
N10 G92 G17 X100.0 Y80.0 ; (P0)
N20 G72.1 P2000 X0 Y0 L8 R45.0 ;
N30 G80 G00 X100.0 Y80.0 ; (P0)
N40 M30 ;
```

Subprogram (rotational copy)

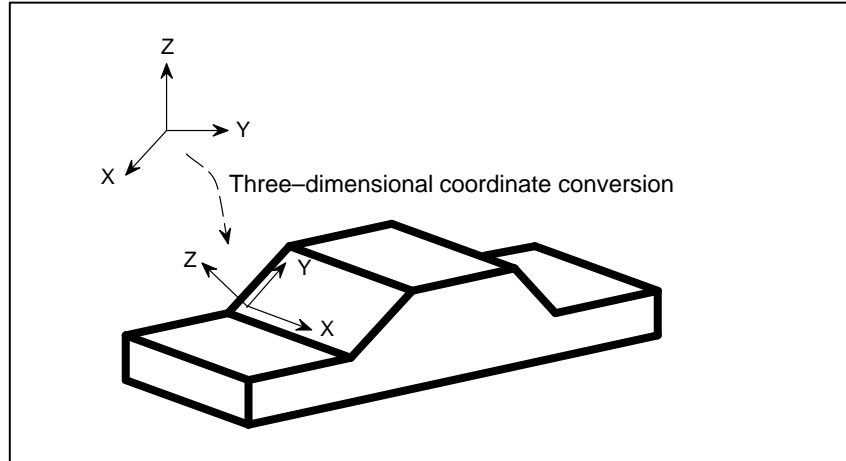
```
O2000 N100 G72.2 P3000 I0 J_ L3 ;
N200 M99 ;
```

Subprogram (linear copy)

```
O3000 N110 G90 G81 X_ Y_ R_ Z_ F_ ; (P1)
N210 M99 ;
```

13.10 THREE- DIMENSIONAL COORDINATE CONVERSION (G68, G69)

Coordinate conversion about an axis can be carried out if the center of rotation, direction of the axis of rotation, and angular displacement are specified. This function is very useful in three-dimensional machining by a die-sinking machine or similar machine. For example, if a program specifying machining on the XY plane is converted by the three-dimensional coordinate conversion function, the identical machining can be executed on a desired plane in three-dimensional space.



Format

G68	$X_p \ x_1 \ Y_p \ y_1 \ Z_p \ z_1 \ I_{j1} \ J_{j1} \ K_{k1} \ R_{\alpha}$;	Starting three-dimensional coordinate conversion
.			
.			
.			
		}	Three-dimensional coordinate conversion mode
G69	;		Canceling three-dimensional coordinate conversion

X_p, Y_p, Z_p : Center of rotation (absolute coordinates) on the X, Y, and Z axis or parallel axes
 I, J, K : Direction of the axis of rotation
 R : Angular displacement

Explanations

- **Command for three-dimensional coordinate conversion (program coordinate system)**

N1 G68 $X_p \ x_1 \ Y_p \ y_1 \ Z_p \ z_1 \ I_{j1} \ J_{j1} \ K_{k1} \ R_{\alpha}$;

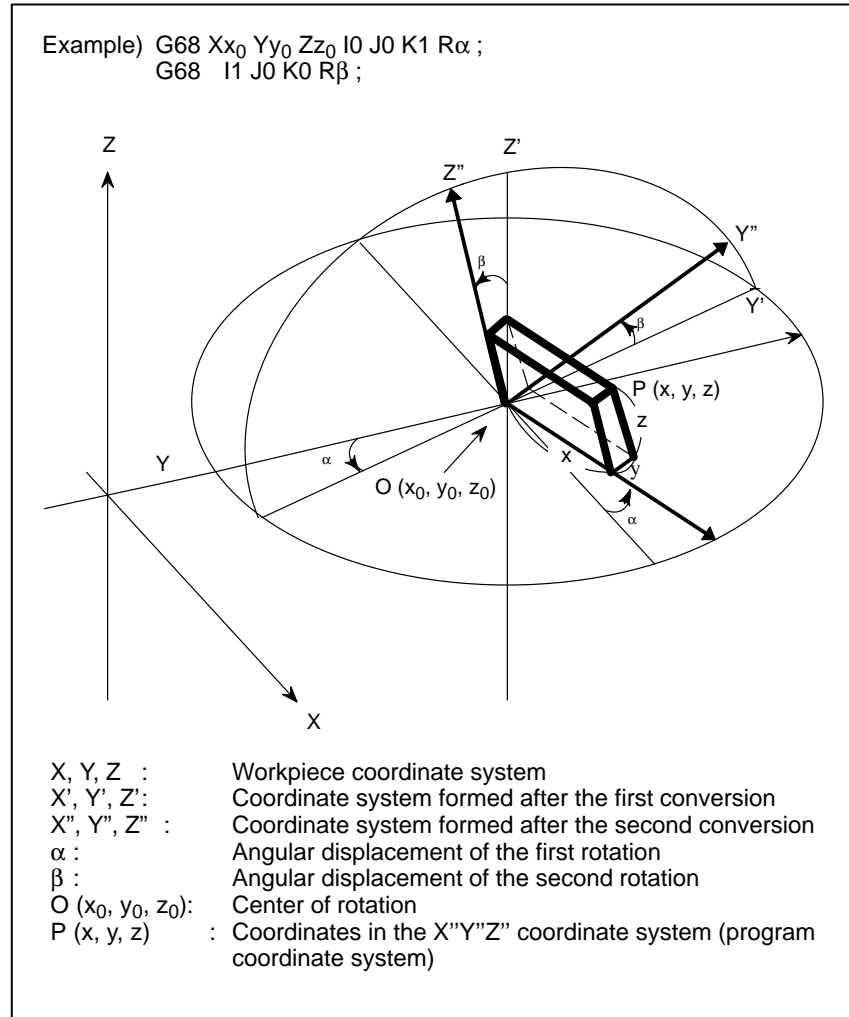
N2 G68 $X_p \ x_2 \ Y_p \ y_2 \ Z_p \ z_2 \ I_{j2} \ J_{j2} \ K_{k2} \ R_{\beta}$;

Three-dimensional coordinate conversion can be executed twice.

In the N1 block, specify the center, direction of the axis of rotation, and angular displacement of the first rotation. When this block is executed, the center of the original coordinate system is shifted to (x_1, y_1, z_1) , then rotated around the vector (i_1, j_1, k_1) by angular displacement α . The new coordinate system is called $X'Y'Z'$. In the N2 block, specify the center, direction of the axis of rotation, and angular displacement of the second rotation. In the N2 block, specify coordinates and the angle with the coordinate system formed after the N1 block in $X_p, Y_p, Z_p, I, J, K,$ and R . When the N2 block is executed, the $X'Y'Z'$ coordinate system is shifted to (x_2, y_2, z_2) , then rotated around the vector (i_2, j_2, k_2) by angular displacement β . The newest coordinate system is called $X''Y''Z''$. In the

subsequent N3 block, coordinates in the $X''Y''Z''$ coordinate system are specified with X_p , Y_p , and Z_p . The $X''Y''Z''$ coordinate system is called the program coordinate system.

If (X_p, Y_p, Z_p) is not specified in the N2 block, (X_p, Y_p, Z_p) in the N1 block is assumed to be the center of the second rotation (the N1 and N2 blocks have a common center of rotation). If the coordinate system is to be rotated only once, the N2 block need not be specified.



● **Format error**

If one of the following format errors is detected, P/S alarm No. 5044 occurs:

1. When I, J, or K is not specified in a block with G68 (a parameter of coordinate system rotation is not specified)
2. When I, J, and K are all set to 0 in a block with G68
3. When R is not specified in a block with G68

● **Center of rotation**

Specify absolute coordinates with X_p , Y_p , and Z_p in the G68 block.

- **Equation for three-dimensional coordinate conversion**

The following equation shows the general relationship between (x, y, z) in the program coordinate system and (X, Y, Z) in the original coordinate system (workpiece coordinate system).

$$\begin{pmatrix} X \\ Y \\ Z \end{pmatrix} = \begin{pmatrix} M_1 \end{pmatrix} \begin{pmatrix} x \\ y \\ z \end{pmatrix} + \begin{pmatrix} x_1 \\ y_1 \\ z_1 \end{pmatrix}$$

When conversion is carried out twice, the relationship is expressed as follows:

$$\begin{pmatrix} X \\ Y \\ Z \end{pmatrix} = \begin{pmatrix} M_1 \end{pmatrix} \begin{pmatrix} M_2 \end{pmatrix} \begin{pmatrix} x \\ y \\ z \end{pmatrix} + \begin{pmatrix} M_1 \end{pmatrix} \begin{pmatrix} x_2 \\ y_2 \\ z_2 \end{pmatrix} + \begin{pmatrix} x_1 \\ y_1 \\ z_1 \end{pmatrix}$$

X, Y, Z : Coordinates in the original coordinate system
(workpiece coordinate system)

x, y, z : Programmed value
(coordinates in the program coordinate system)

x₁, y₁, z₁ : Center of rotation of the first conversion

x₂, y₂, z₂ : Center of rotation of the second conversion
(coordinates in the coordinate system formed after the first conversion)

M₁ : First conversion matrix

M₂ : Second conversion matrix

M1 and M2 are conversion matrices determined by an angular displacement and rotation axis. Generally, the matrices are expressed as shown below:

$$\begin{pmatrix} n_1^2 + (1 - n_1^2) \cos\theta & n_1 n_2 (1 - \cos\theta) - n_3 \sin\theta & n_1 n_3 (1 - \cos\theta) + n_2 \sin\theta \\ n_1 n_2 (1 - \cos\theta) + n_3 \sin\theta & n_2^2 + (1 - n_2^2) \cos\theta & n_2 n_3 (1 - \cos\theta) - n_1 \sin\theta \\ n_1 n_3 (1 - \cos\theta) - n_2 \sin\theta & n_2 n_3 (1 - \cos\theta) + n_1 \sin\theta & n_3^2 + (1 - n_3^2) \cos\theta \end{pmatrix}$$

n₁ : Cosine of the angle made by the rotation axis and X-axis $\frac{i}{p}$

n₂ : Cosine of the angle made by the rotation axis and Y-axis $\frac{j}{p}$

n₃ : Cosine of the angle made by the rotation axis and Z-axis $\frac{k}{p}$

θ: Angular displacement

Value p is obtained by the following:

$$p = \sqrt{i^2 + j^2 + k^2}$$

Conversion matrices for rotation on two-dimensional planes are shown below:

(1) Coordinate conversion on the XY plane

$$M = \begin{pmatrix} \cos\theta & -\sin\theta & 0 \\ \sin\theta & \cos\theta & 0 \\ 0 & 0 & 1 \end{pmatrix}$$

(2) Coordinate conversion on the YZ plane

$$M = \begin{pmatrix} 1 & 0 & 0 \\ 0 & \cos\theta & -\sin\theta \\ 0 & \sin\theta & \cos\theta \end{pmatrix}$$

(3) Coordinate conversion on the ZX plane

$$M = \begin{pmatrix} \cos\theta & 0 & \sin\theta \\ 0 & 1 & 0 \\ -\sin\theta & 0 & \cos\theta \end{pmatrix}$$

- **Three basic axes and their parallel axes**

Three-dimensional coordinate conversion can be applied to a desired combination of three axes selected out of the basic three axes (X, Y, Z) and their parallel axes. The three-dimensional coordinate system subjected to three-dimensional coordinate conversion is determined by axis addresses specified in the G68 block. If Xp, Yp, or Zp is not specified, X, Y, or Z of the basic three axes is assumed. However, if the basic three axes are not specified in parameter 1022, P/S alarm No. 048 occurs.

In a single G68 block, both a basic axis and a parallel axis cannot be specified. If this is attempted, P/S alarm No.047 occurs.

(Example)

When U-axis, V-axis, and W-axis are parallel to the X-axis, Y-axis, and Z-axis respectively

G68 X_I_J_K_R_ ; XYZ coordinate system

G68 U_V_Z_I_J_K_R_ ; UVZ coordinate system

G68 W_I_J_K_R_ ; XYW coordinate system

- **Specifying the second conversion**

Three-dimensional coordinate conversion can be executed twice. The center of rotation of the second conversion must be specified with the axis addresses specified for the first conversion. If the axis addresses of the second conversion are different from the axis addresses of the first conversion, the different axis addresses are ignored. An attempt to execute three-dimensional coordinate conversion three or more times causes P/S alarm No.5043.

- **Angular displacement R**

A positive angular displacement R indicates a clockwise rotation along the axis of rotation. Specify angular displacement R in 0.001 degrees within the range of -360000 to 360000.

- **G codes that can be specified**

The following G codes can be specified in the three-dimensional coordinate conversion mode:

G00	Positioning
G01	Linear interpolation
G02	Circular interpolation (clockwise)
G03	Circular interpolation (counterclockwise)
G04	Dwell
G10	Data setting
G17	Plane selection (XY)
G18	Plane selection (ZX)
G19	Plane selection (YZ)
G28	Reference position return
G29	Return from the reference position
G30	Return to the second, third, or fourth reference position
G40	Canceling cutter compensation
G41	Cutter compensation to the left
G42	Cutter compensation to the right
G43	Increasing tool length compensation
G44	Decreasing tool length compensation
G45	Increasing the tool offset
G46	Decreasing the tool offset
G47	Doubling the tool offset
G48	Halving the tool offset
G49	Canceling tool length compensation
G50.1	Canceling programmable mirror image
G51.1	Programmable mirror image

G53	Selecting the machine coordinate system
G65	Custom macro calling
G66	Continuous-state custom macro calling
G67	Canceling continuous-state custom macro calling
G73	Canned cycle (peck drilling cycle)
G74	Canned cycle (reverse tapping cycle)
G76	Canned cycle (fine boring cycle)
G80	Canceling a canned cycle
G81 to G89	Canned cycle
G90	Absolute mode
G91	Incremental mode
G94	Feed per minute
G95	Feed per rotation
G98	Canned cycle (return to the initial level)
G99	Canned cycle (return to the level of point R)

- **Rapid traverse rate in drilling of a canned cycle**

In the three-dimensional coordinate conversion mode, the rapid traverse rate in drilling of a canned cycle equals the maximum cutting feedrate.

- **Compensation functions**

If tool length compensation, cutter compensation, or tool offset is specified with three-dimensional coordinate conversion, compensation is performed first, followed by three-dimensional coordinate conversion.

- **Relationship between three-dimensional and two-dimensional coordinate conversion (G68, G69)**

Three-dimensional and two-dimensional coordinate conversion use identical G codes (G68 and G69). A G code specified with I, J, and K is processed as the command for three-dimensional coordinate conversion. A G code not specified with I, J, and K is processed as the command for two-dimensional coordinate conversion.

- **Custom macro system variables**

Coordinates on the workpiece coordinate system are assigned to system variables #5041 to #5048 (current position on each axis).

- **Reset**

If a reset occurs during three-dimensional coordinate conversion mode, the mode is canceled and the continuous-state G code is changed to G69.

- **Absolute position display**

The absolute coordinates based on the program or workpiece coordinate system can be displayed in the three-dimensional coordinate conversion mode. Specify a desired coordinate system in the DAK bit (bit 6 of parameter 3106).

- **Three-dimensional rigid tapping**

By specifying the rigid tapping command in three-dimensional coordinate conversion mode, tapping can be executed in the direction of the angle programmed by the three-dimensional coordinate conversion command.

In three-dimensional coordinate conversion mode, "Position Error Z", displayed on the spindle adjustment screen, is taken from the longitudinal tapping axis after three-dimensional conversion.

Positioning in three-dimensional coordinate conversion mode must be linear interpolation positioning (the LRP bit (bit 1 of parameter 1401) is set to 1).

Three-dimensional rigid tapping cannot be executed for an axis under simple synchronous control.

Limitations

- **manual intervention** Three-dimensional coordinate conversion does not affect the degree of manual intervention or manual handle interrupt.

- **Positioning in the machine coordinate system** Three-dimensional coordinate conversion does not affect positioning in the machine coordinate system (e.g. specified with G28, G30, or G53).

- **Specifying rapid traverse** Specify linear rapid traverse when three-dimensional coordinate conversion is executed. (Set the LRP bit, bit 1 of parameter No.1401, to 1.)

- **Block with G68 or G69** In a block with G68 or G69, other G codes must not be specified. G68 must be specified with I, J, and K.

- **Mirror image** Programmable mirror image can be specified, but external mirror image (mirror image by the mirror image signal or setting) cannot be specified. Three-dimensional coordinate conversion is carried out after the programmable mirror image function is executed.

- **Position display and compensation** To display the absolute position when three-dimensional coordinate conversion is executed, set bits 4 to 7 of parameter DRL, DRC, DAL, and DAC No.3104 to 0.

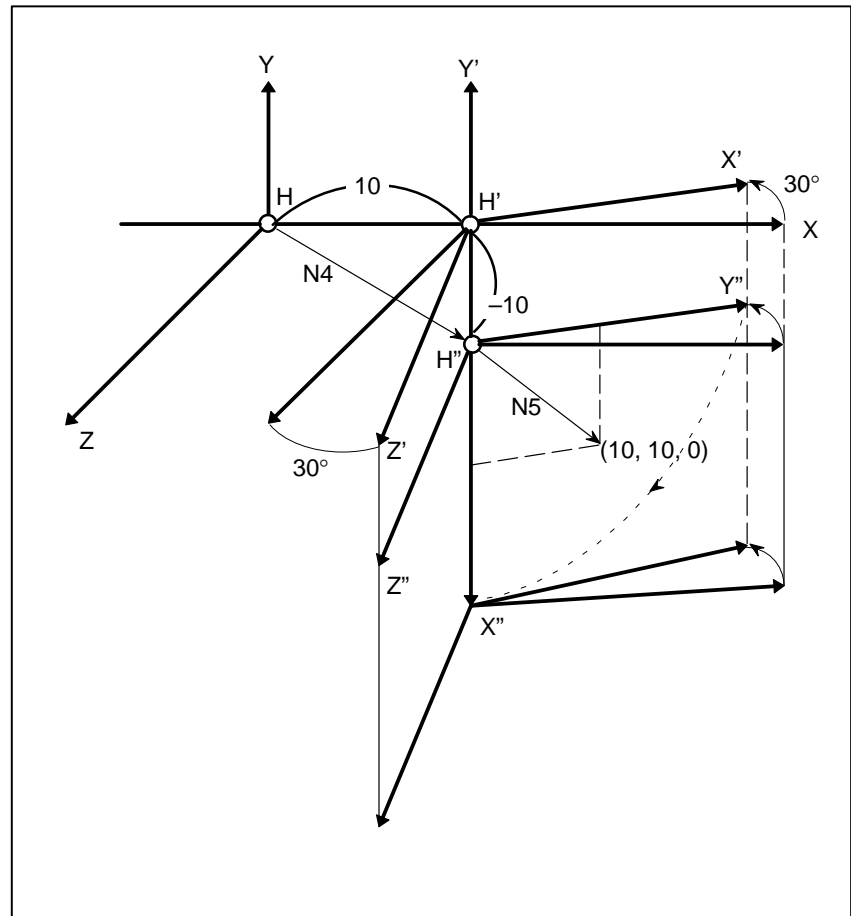
- **Three-dimensional coordinate conversion and other continuous-state commands** Canned cycles G41, G42, or G51.1 must be nested between G68 and G69.
 (Example)


```

      - - - - G68 X100. Y100. Z100. I0. J0. K1. R45. ;
      - - - - G41 D01 ;
      - - - -      ;
      - - - - G40 ;
      - - - -      ;
      - - - - G69 ;
      - - - -      ;
      
```

Examples

- N1 G90 X0 Y0 Z0 ; Carries out positioning to zero point H.
- N2 G68 X10. Y0 Z0 I0 J1 K0 R30. ; Forms new coordinate system X'Y'Z'.
- N3 G68 X0 Y-10. Z0 I0 J0 K1 R-90. ; Forms other coordinate system X''Y''Z''.
- The origin agrees with (0, -10, 0) in coordinate system X'Y'Z.
- N4 G90 X0 Y0 Z0 ; Carries out positioning to zero point H'' on coordinate system X''Y''Z''.
- N5 X10. Y10. Z0 ; Carries out positioning to (10, 10, 0) on coordinate system X''Y''Z''.



13.11 INDEX TABLE INDEXING FUNCTION

By specifying indexing positions (angles) for the indexing axis (one rotation axis, A, B, or C), the index table of the machining center can be indexed.

Before and after indexing, the index table is automatically unclamped or clamped.

Explanations

• Indexing position

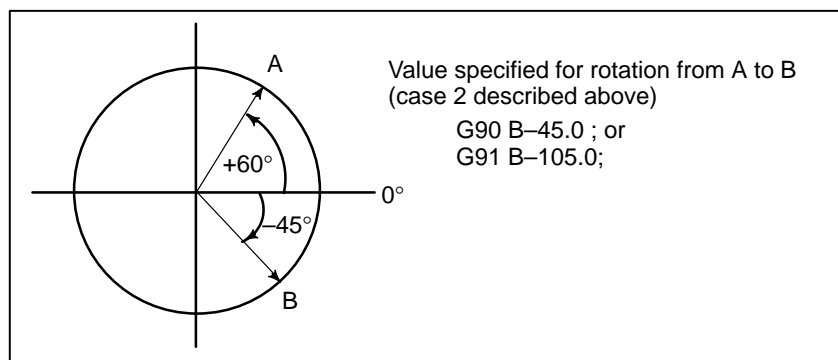
Specify an indexing position with address A, B, or C (set to bit 0 of parameter ROT_x No.1006).

The indexing position is specified by either of the following (depending on bit 4 of parameter G90 No.5500):

1. Absolute value only
2. Absolute or incremental value depending on the specified G code: G90 or G91

A positive value indicates an indexing position in the counterclockwise direction. A negative value indicates an indexing position in the clockwise direction.

The minimum indexing angle of the index table is the value set to parameter 5512. Only multiples of the least input increment can be specified as the indexing angle. If any value that is not a multiple is specified, an P/S alarm (No. 135) occurs. Decimal fractions can also be entered. When a decimal fraction is entered, the 1's digit corresponds to degree units.



• Direction and value of rotation

The direction of rotation and angular displacement are determined by either of the following two methods. Refer to the manual written by the machine tool builder to find out which method is applied.

1. Using the miscellaneous function specified in parameter No. 5511 (Address) (Indexing position) (Miscellaneous function);
Rotation in the negative direction (Address) (Indexing position);
Rotation in the positive direction (No miscellaneous functions are specified.)

An angular displacement greater than 360° is rounded down to the corresponding angular displacement within 360° when bit 2 of parameter ABS No. 5500 specifies this option.

For example, when G90 B400.0 (miscellaneous function); is specified at a position of 0, the table is rotated by 40° in the negative direction.

2. Using no miscellaneous functions

By setting to bits 2, 3, and 4 of parameter ABS, INC,G90 No.5500, operation can be selected from the following two options.

Select the operation by referring to the manual written by the machine tool builder.

(1) Rotating in the direction in which an angular displacement becomes shortest

This is valid only in absolute mode. A specified angular displacement greater than 360° is rounded down to the corresponding angular displacement within 360° when bit 2 of parameter ABS No.5500 specifies this option.

For example, when G90 B400.0; is specified at a position of 0, the table is rotated by 40° in the positive direction.

(2) Rotating in the specified direction

In the absolute mode, the value set in bit 2 of parameter ABS No.5500 determines whether an angular displacement greater than 360° is rounded down to the corresponding angular displacement within 360°.

In the incremental mode, the angular displacement is not rounded down.

For example, when G90 B720.0; is specified at a position of 0, the table is rotated twice in the positive direction, when the angular displacement is not rounded down.

● **Feedrate**

The table is always rotated around the indexing axis in the rapid traverse mode.

Dry runs cannot be executed for the indexing axis.

WARNING

If a reset is made during indexing of the index table, a reference position return must be made before each time the index table is indexed subsequently.

NOTE

- 1 Specify the indexing command in a single block. If the command is specified in a block in which another controlled axis is specified, P/S alarm (No.136) occurs.
- 2 The waiting state which waits for completion of clamping or unclamping of the index table is indicated on diagnostic screen 12.
- 3 The miscellaneous function specifying a negative direction is processed in the CNC.
The relevant M code signal and completion signal are sent between the CNC and the machine.
- 4 If a reset is made while waiting for completion of clamping or unclamping, the clamp or unclamp signal is cleared and the CNC exits the completion wait state.

- **Indexing function and other functions**

Table13.11 (a) Index indexing function and other functions

Item	Explanation
Relative position display	This value is rounded down when bit 1 of parameter REL No. 5500 specifies this option.
Absolute position display	This value is rounded down when bit 2 of parameterABS No. 5500 specifies this option.
Automatic return from the reference position (G29) 2nd reference position return (G30)	Impossible to return
Movement in the machine coordinate system	Impossible to move
Single direction positioning	Impossible to specify
2nd auxiliary function (B code)	Possible with any address other than B that of the indexing axis.
Operations while moving the indexing axis	Unless otherwise processed by the machine, feed hold, interlock and emergency stop can be executed. Machine lock can be executed after indexing is completed.
SERVO OFF signal	Disabled The indexing axis is usually in the servo-off state.
Incremental commands for indexing the index table	The workpiece coordinate system and machine coordinate system must always agree with each other on the indexing axis (the workpiece zero point offset value is zero.).
Operations for indexing the index table	Manual operation is disabled in the JOG, INC, or HANDLE mode. A manual reference position return can be made. If the axis selection signal is set to zero during manual reference position return, movement is stopped and the clamp command is not executed.

14

COMPENSATION FUNCTION

General

This chapter describes the following compensation functions:

- 14.1 TOOL LENGTH OFFSET (G43, G44, G49)
- 14.2 AUTOMATIC TOOL LENGTH MEASUREMENT (G37)
- 14.3 TOOL OFFSET (G45–G48)
- 14.4 CUTTER COMPENSATION B (G39–G42)
- 14.5 CUTTER COMPENSATION C (G40–G42)
- 14.6 DETAILS OF CUTTER COMPENSATION C
- 14.7 THREE-DIMENSIONAL TOOL COMPENSATION (G40, G41)
- 14.8 TOOL COMPENSATION VALUES, NUMBER OF COMPENSATION VALUES, AND ENTERING VALUES FROM THE PROGRAM (G10)
- 14.9 SCALING (G50, G51)
- 14.10 COORDINATE SYSTEM ROTATION (G68, G69)
- 14.11 NORMAL DIRECTION CONTROL (G40.1, G41.1, G42.1 OR G150, G151, G152)
- 14.12 PROGRAMMABLE MIRROR IMAGE (G50.1, G51.1)
- 14.13 GRINDING WHEEL WEAR COMPENSATION

14.1 TOOL LENGTH OFFSET (G43,G44,G49)

This function can be used by setting the difference between the tool length assumed during programming and the actual tool length of the tool used into the offset memory. It is possible to compensate the difference without changing the program.

Specify the direction of offset with G43 or G44. Select a tool length offset value from the offset memory by entering the corresponding address and number (H code).

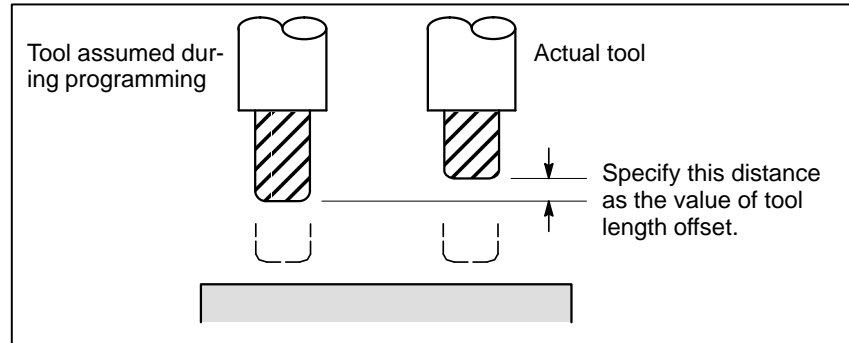


Fig14.1 Tool length offset

The following three methods of tool length offset can be used, depending on the axis along which tool length offset can be made.

· **Tool length offset A**

Compensates for the difference in tool length along the Z-axis.

· **Tool length offset B**

Compensates for the difference in tool length along the X-, Y-, or Z-axis.

· **Tool length offset C**

Compensates for the difference in tool length along a specified axis.

14.1.1 General

Format

Tool length offset A	G43 Z_ H_ ; G44 Z_ H_ ;	Explanation of each address G43 : Positive offset G44 : Negative offset G17 : XY plane selection G18 : ZX plane selection G19 : YZ plane selection α : Address of a specified axis H : Address for specifying the tool length offset value
Tool length offset B	G17 G43 Z_ H_ ; G17 G44 Z_ H_ ; G18 G43 Y_ H_ ; G18 G44 Y_ H_ ; G19 G43 X_ H_ ; G19 G44 X_ H_ ;	
Tool length offset C	G43 α _ H_ ; G44 α _ H_ ;	
Tool length offset cancel	G49 ; or H0 ;	

(2) Cutter compensation C

When the offset numbers for cutter compensation C are specified or modified, the offset number validation order varies, depending on the condition, as described below.

- When OFH (bit 2 of parameter No. 5001) = 0

Oxxxx;		
H01 ;		
⋮		
G43P_ ;	(1)	(1) Offset number H01 is valid.
⋮		(2) Offset number H02 is valid.
G44P_H02 ;	(2)	(3) Offset number H03 is valid only for the axis to which compensation was applied most recently.
⋮		
H03 ;	(3)	
⋮		

- When OFH (bit 2 of parameter No. 5001) = 1

Oxxxx;		
H01 ;		
⋮		
G43P_ ;	(1)	(1) Offset number H00 is valid.
⋮		(2) Offset number H02 is valid.
G44P_H02 ;	(2)	(3) Offset number H02 is valid.
⋮		(However, the H number displayed is changed to 03.)
H03 ;	(3)	
⋮		

The tool length offset value may be set in the offset memory through the CRT/MDI panel.

The range of values that can be set as the tool length offset value is as follows.

	Metric input	Inch input
Tool length offset value	0 to ±999.999mm	0 to ±99.9999inch

WARNING

When the tool length offset value is changed due to a change of the offset number, the offset value changes to the new tool length offset value, the new tool length offset value is not added to the old tool length offset value.

H1 : tool length offset value 20.0

H2 : tool length offset value 30.0

G90 G43 Z100.0 H1 ; Z will move to 120.0

G90 G43 Z100.0 H2 ; Z will move to 130.0

CAUTION

When the tool length offset is used and set a parameter OFH (No. 5001#2) to 0, specify the tool length offset with H code and the cutter compensation with D code.

NOTE

The tool length offset value corresponding to offset No. 0, that is, H0 always means 0. It is impossible to set any other tool length offset value to H0.

- **Performing tool length offset along two or more axes**

Tool length offset B can be executed along two or more axes when the axes are specified in two or more blocks.

Offset in X and Y axes.

G19 G43 H _ ; Offset in X axis

G18 G43 H _ ; Offset in Y axis

(Offsets in X and Y axes are performed)

If the TAL bit (bit 3 of parameter No. 5001) is set to 1, an alarm will not occur even when tool length offset C is executed along two or more axes at the same time.

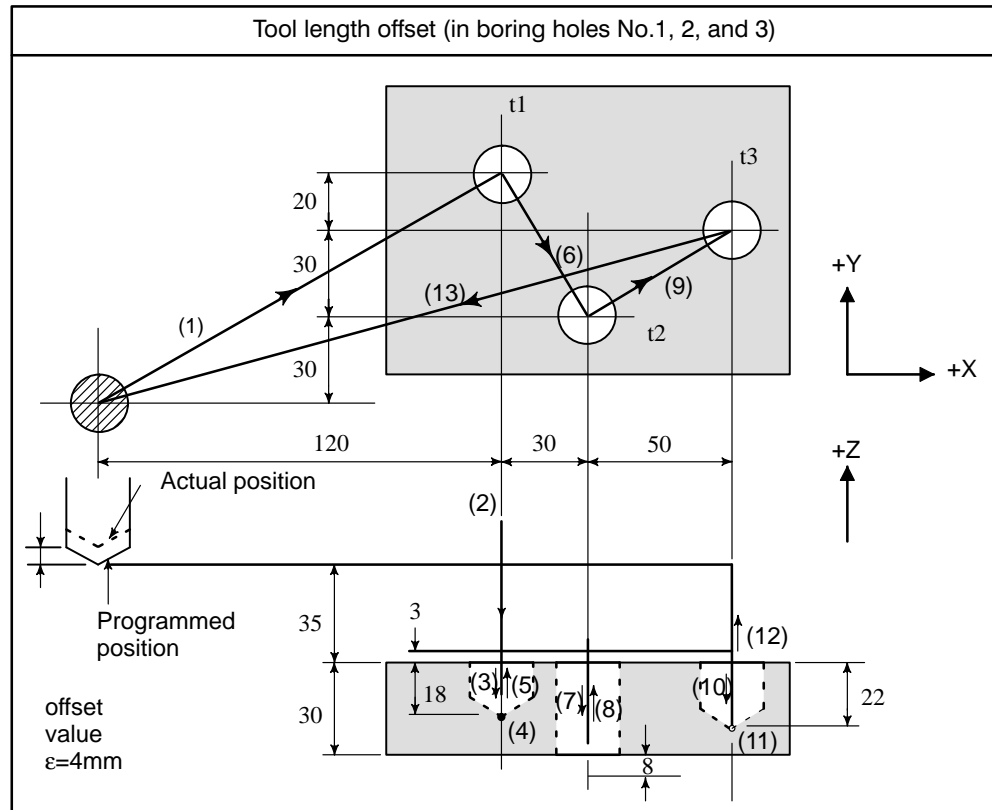
- **Tool length offset cancel**

To cancel tool length offset, specify G49 or H0. After G49 or H0 is specified, the system immediately cancels the offset mode.

NOTE

- After tool length offset B is executed along two or more axes, offset along all the axes is canceled by specifying G49. If H0 is specified, only offset along an axis perpendicular to the specified plane is canceled.
- In the case of the offset in three axes or more, if the offset is canceled by G49 code, the P/S alarm 015 is generated. Cancel the offset by using G49 and H0.

Examples



·Program

```

H1=-4.0 (Tool length offset value)
N1 G91 G00 X120.0 Y80.0 ;           (1)
N2 G43 Z-32.0 H1 ;                 (2)
N3 G01 Z-21.0 F1000 ;              (3)
N4 G04 P2000 ;                     (4)
N5 G00 Z21.0 ;                     (5)
N6 X30.0 Y-50.0 ;                  (6)
N7 G01 Z-41.0 ;                    (7)
N8 G00 Z41.0 ;                     (8)
N9 X50.0 Y30.0 ;                   (9)
N10 G01 Z-25.0 ;                   (10)
N11 G04 P2000 ;                    (11)
N12 G00 Z57.0 H0 ;                 (12)
N13 X-200.0 Y-60.0 ;               (13)
N14 M2 ;

```

14.1.2 G53, G28, G30, and G30.1 Commands in Tool Length Offset Mode

This section describes the tool length offset cancellation and restoration performed when G53, G28, G30, or G31 is specified in tool length offset mode. Also described is the timing of tool length offset.

- (1) Tool length offset vector cancellation and restoration, performed when G53, G28, G30, or G30.1 is specified in tool length offset mode
- (2) Specification of the G43/G44 command for tool length offset A/B/C, and independent specification of the H command

Explanations

- **Tool length offset vector cancellation**

When G53, G28, G30, or G30.1 is specified in tool length offset mode, tool length offset vectors are canceled as described below. However, the previously specified modal G code remains displayed; modal code display is not switched to G49.

- (1) When G53 is specified

Command	Specified axis	Common to type A/B/C
G53P_;	Tool length offset axis	Canceled upon movement being performed according to a specified value
	Other than tool length offset axis	Not canceled

NOTE

When tool length offset is applied to multiple axes, all specified axes are subject to cancellation.

When tool length offset cancellation is specified at the same time, tool length offset vector cancellation is performed as indicated below.

Command	Specified axis	Common to type A/B/C
G49G53P_;	Tool length offset axis	Canceled upon movement being performed according to a specified value
	Other than tool length offset axis	Canceled upon movement being performed according to a specified value

- (2) When G28, G30, or G30.1 is specified

Command	Specified axis	Common to type A/B/C
G28P_;	Tool length offset axis	Canceled upon movement to a reference position being performed
	Other than tool length offset axis	Not canceled

NOTE

When tool length offset is applied to multiple axes, all specified axes involved in reference position return are subject to cancellation.

When tool length offset cancellation is specified at the same time, tool length offset vector cancellation is performed as indicated below.

Command	Specified axis	Common to type A/B/C
G49G28P_;	Tool length offset axis	Canceled upon movement to an intermediate position being performed
	Other than tool length offset axis	Canceled upon movement to an intermediate position being performed

- **Tool length offset vector restoration**

Tool length offset vectors, canceled by specifying G53, G28, G30, or G30.1 in tool length offset mode, are restored as described below.

(1) When OFH (bit 2 of parameter No. 5001) = 0

Type	EVO (bit 6 of parameter No. 5001)	Restoration block
A/B	1	Block to be buffered next
	0	Block containing an H command or G43/44 command
C	Ignored	Block containing an H command Block containing a G43P_/G44P_ command

(2) When OFH (bit 2 of parameter No. 5001) = 1

In a mode other than tool length offset mode

Type	EVO (bit 6 of parameter No. 5001)	Restoration block
A/B	1	Block to be buffered next
	0	Block containing an H command or G43/44 command
C	Ignored	Block containing an H command Block containing a G43P_/G44P_ command

In tool length offset mode

Type	EVO (bit 6 of parameter No. 5001)	Restoration block
A/B	1	Block containing a G43/G44 block
	0	Block containing an H command and G43/44 command
C	Ignored	Block containing a G43P_H_/G44P_H_ command

WARNING

When tool length offset is applied to multiple axes, all axes for which G53, G28, G30, and G30.1 are specified are subject to cancellation. However, restoration is performed only for that axis to which tool length offset was applied last; restoration is not performed for any other axes.

NOTE

In a block containing G40, G41, or G42, the tool length offset vector is not restored.

14.2 AUTOMATIC TOOL LENGTH MEASUREMENT (G37)

By issuing G37 the tool starts moving to the measurement position and keeps on moving till the approach end signal from the measurement device is output. Movement of the tool is stopped when the tool tip reaches the measurement position.

Difference between coordinate value when tool reaches the measurement position and coordinate value commanded by G37 is added to the tool length offset amount currently used.

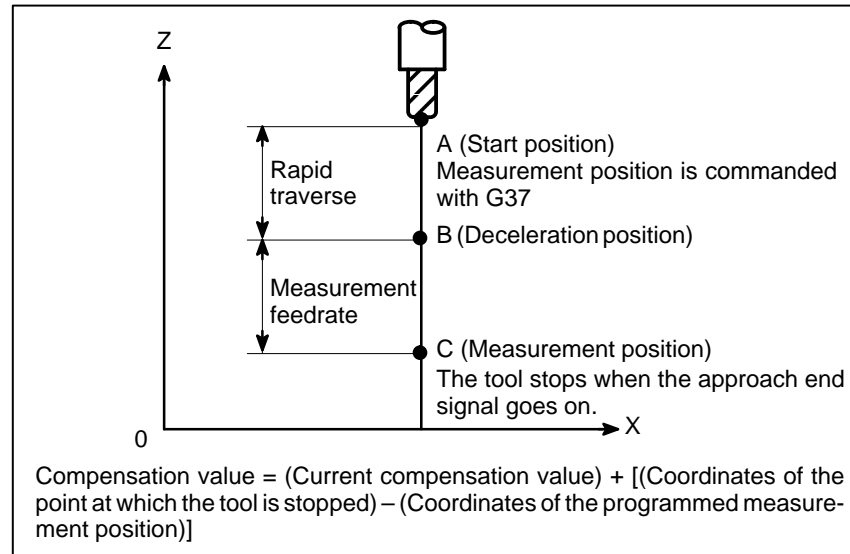


Fig14.2(a).Automatic tool length measurement

Format

G92 IP_n ; Sets the workpiece coordinate system. (It can be set with G54 to G59. See Chapter 7, "Coordinate System.")
H○○; Specifies an offset number for tool length offset.

G90 G37 IP_n ; Absolute command
 G37 is valid only in the block in which it is specified.
 IP_n indicates the X-, Y-, Z-, or fourth axis.

Explanations

- **Setting the workpiece coordinate system**

Set the workpiece coordinate system so that a measurement can be made after moving the tool to the measurement position. The coordinate system must be the same as the workpiece coordinate system for programming.

- **Specifying G37**

Specify the absolute coordinates of the correct measurement position. Execution of this command moves the tool at the rapid traverse rate toward the measurement position, reduces the feedrate halfway, then continues to move it until the approach end signal from the measuring instrument is issued. When the tool tip reaches the measurement position, the measuring instrument sends an approach end signal to the CNC which stops the tool.

- **Changing the offset value**

The difference between the coordinates of the position at which the tool reaches for measurement and the coordinates specified by G37 is added to the current tool length offset value.

Offset value =

(Current compensation value) + [(Coordinates of the position at which the tool reaches for measurement) – (Coordinates specified by G37)]

These offset values can be manually changed from MDI.

- **Alarm**

When automatic tool length measurement is executed, the tool moves as shown in Fig. 14.2 (b). If the approach end signal goes on while the tool is traveling from point B to point C, an alarm occurs. Unless the approach end signal goes on before the tool reaches point F, the same alarm occurs. The P/S alarm number is 080.

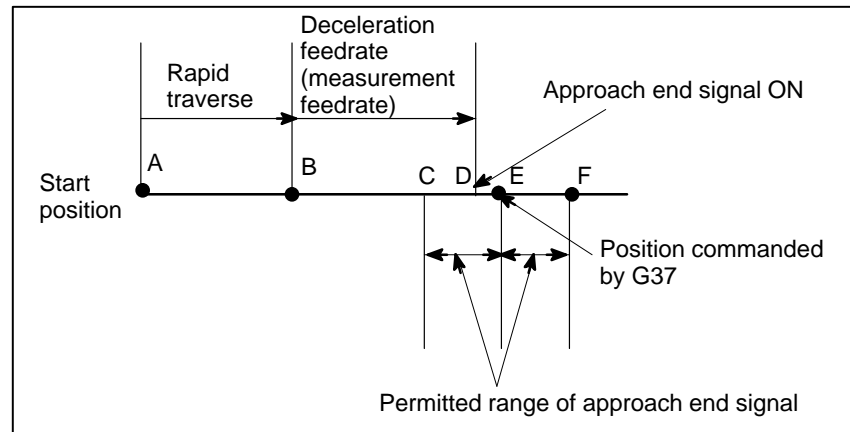


Fig14.2 (b) Tool movement to the measurement position

WARNING

When a manual movement is inserted into a movement at a measurement federate, return the tool to the position before the inserted manual movement for restart.

NOTE

- 1 When an H code is specified in the same block as G37, an alarm is generated. Specify H code before the block of G37.
- 2 The measurement speed (parameter No. 6241), deceleration position (parameter No. 6251), and permitted range of the approach end signal (parameter No. 6254) are specified by the machine tool builder.
- 3 When offset memory A is used, the offset value is changed. When offset memory B is used, the tool wear compensation value is changed. When offset memory C is used, the tool wear compensation value for the H code is changed.
- 4 The approach end signal is monitored usually every 2 ms. The following measuring error is generated:

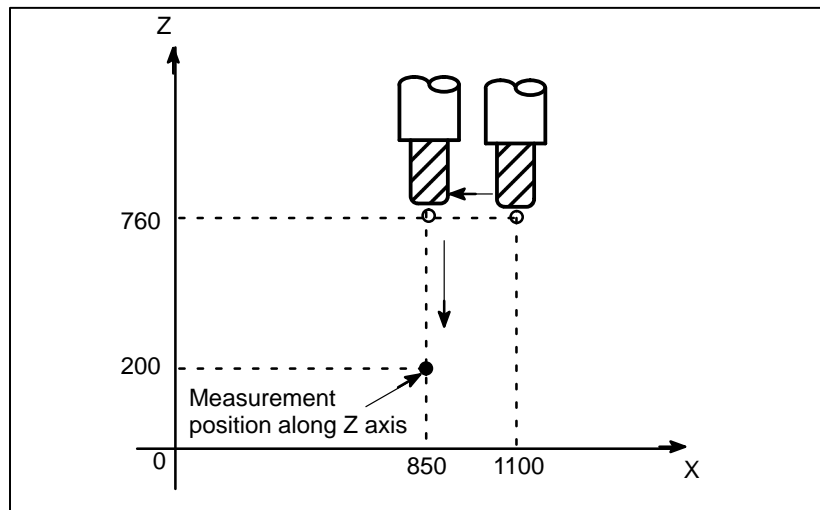
$$ERR_{max.} = F_m \times 1/60 \times T_S / 1000$$
where
 T_S : Sampling period, for usual 2 (ms)
 $ERR_{max.}$: maximum measuring error (mm)
 F_m : measurement federate (mm/min.)
For example, when $F_m = 1000$ mm/min., $ERR_{max.} = 0.003$ mm
- 5 The tool stops a maximum of 16 ms after the approach end signal is detected. But the value of the position at which the approach end signal was detected (note the value when the tool stopped) is used to determine the offset amount. The overrun for 16 ms is:

$$Q_{max.} = F_m \times 1/60 \times 16 / 1000$$
 $Q_{max.}$: maximum overrun (mm)
 F_m : measurement federate (mm/min.)

Examples

- G92 Z760.0 X1100.0 ;** Sets a workpiece coordinate system with respect to the programmed absolute zero point.
- G00 G90 X850.0 ;** Moves the tool to X850.0.
That is the tool is moved to a position that is a specified distance from the measurement position along the Z-axis.
- H01 ;** Specifies offset number 1.
- G37 Z200.0 ;** Moves the tool to the measurement position.
- G00 Z204.0 ;** Retracts the tool a small distance along the Z-axis.

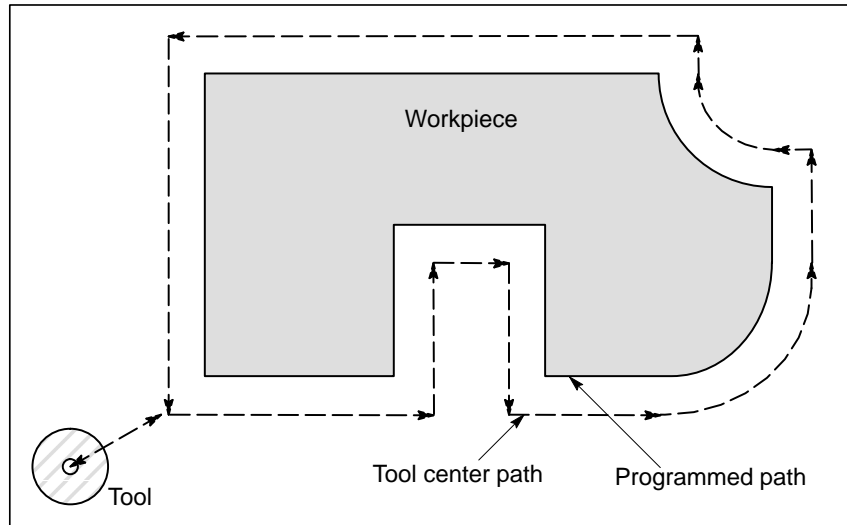
For example, if the tool reaches the measurement position with Z198.0;, the compensation value must be corrected. Because the correct measurement position is at a distance of 200 mm, the compensation value is lessened by 2.0 mm ($198.0 - 200.0 = -2.0$).



14.3 TOOL OFFSET (G45–G48)

The programmed travel distance of the tool can be increased or decreased by a specified tool offset value or by twice the offset value.

The tool offset function can also be applied to an additional axis.



Format

G45 IP_D_ ; Increase the travel distance by the tool offset value

G46 IP_D_ ; Decrease the travel distance by the tool offset value

G47 IP_D_ ; Increase the travel distance by twice the tool offset value

G48 IP_D_ ; Decrease the travel distance by twice the tool offset value

G45 to G48 : One-shot G code for increasing or decreasing the travel distance

IP : Command for moving the tool

D : Code for specifying the tool offset value

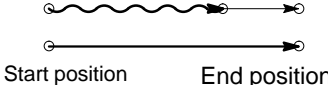
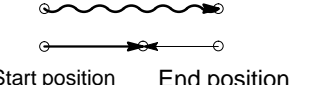
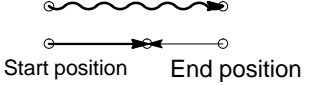
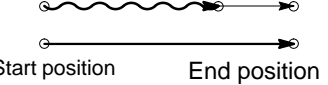
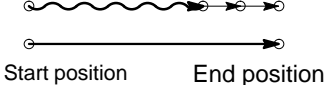
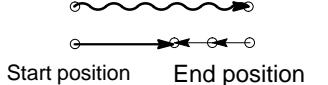
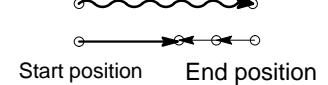
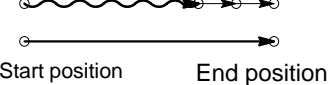
Explanations

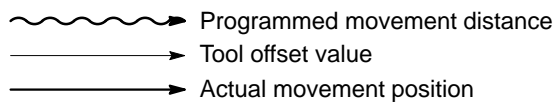
- **Increase and decrease**

As shown in Table 14.3(a), the travel distance of the tool is increased or decreased by the specified tool offset value.

In the absolute mode, the travel distance is increased or decreased as the tool is moved from the end position of the previous block to the position specified by the block containing G45 to G48.

Table14.3(a) Increase and decrease of the tool travel distance

G code	When a positive tool offset value is specified	When a negative tool offset value is specified
G45		
G46		
G47		
G48		



If a move command with a travel distance of zero is specified in the incremental command (G91) mode, the tool is moved by the distance corresponding to the specified tool offset value.

If a move command with a travel distance of zero is specified in the absolute command (G90) mode, the tool is not moved.

- **Tool offset value**

Once selected by D code, the tool offset value remains unchanged until another tool offset value is selected.

Tool offset values can be set within the following range:

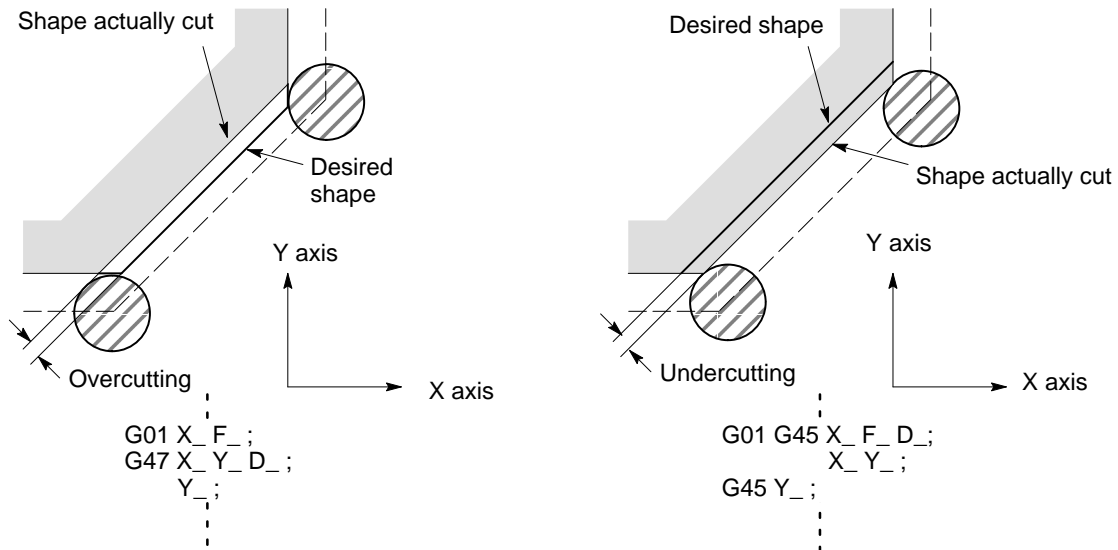
Table14.3(b) Range of tool offset values

	Metric input	inch input
Tool offset value	0 to ±999.999mm	0 to ±99.9999inch
	0 to ±999.999deg	0 to ±999.999deg

D0 always indicates a tool offset value of zero.

WARNING

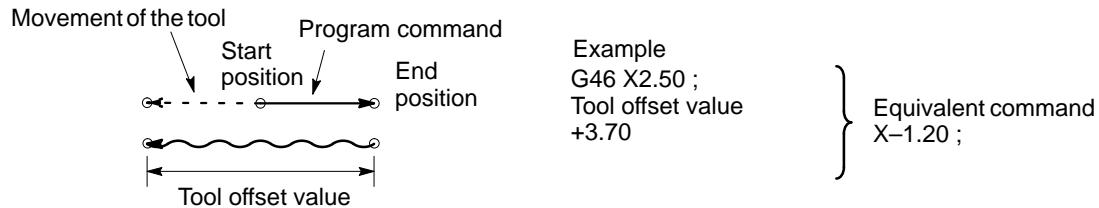
- 1 When G45 to G48 is specified to n axes (n=1–6) simultaneously in a motion block, offset is applied to all n axes.
 When the cutter is offset only for cutter radius or diameter in taper cutting, overcutting or undercutting occurs.
 Therefore, use cutter compensation (G40 or G42) shown in II-14.4 or 14.5.



- 2 G45 to G48 (tool offset) must not be used in the G41 or G42 (cutter compensation) mode.

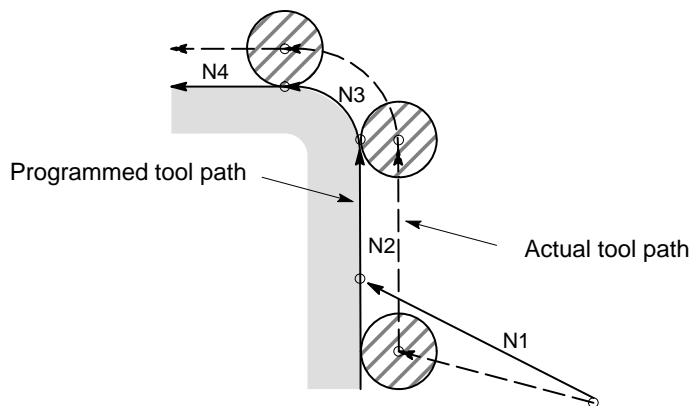
NOTE

- 1 When the specified direction is reversed by decrease as shown in the figure below, the tool moves in the opposite direction.



- 2 Tool offset can be applied to circular interpolation (G02, G03) with the G45 to G48 commands only for 1/4 and 3/4 circles using addresses I, J and K by the parameter setting, providing that the coordinate rotation be not specified at the same time. This function is provided for compatibility with the conventional CNC tape without any cutter compensation. The function should not be used when a new CNC program is prepared.

Tool offset for circular interpolation

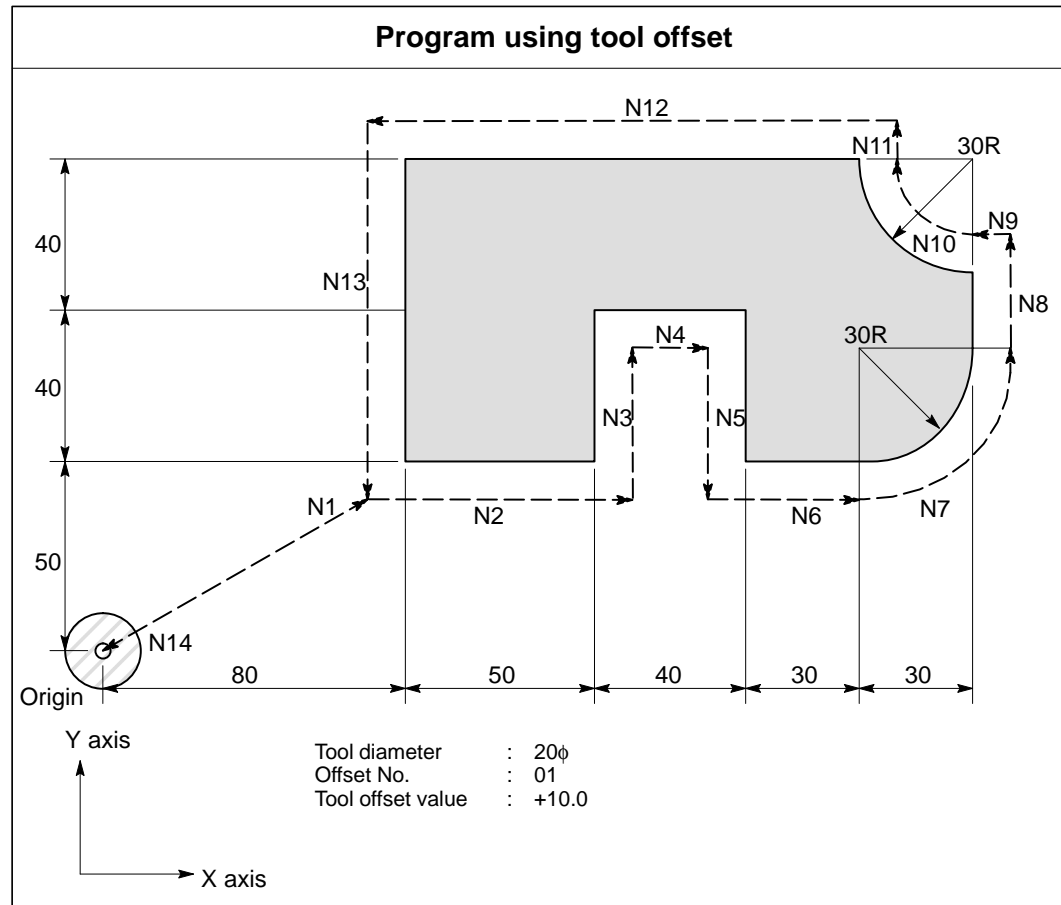


Program

```
N1 G46 G00 X_ Y_ D_ ;
N2 G45 G01 Y_ F_ ;
N3 G45 G03 X_ Y_ I_ ;
N4 G01 X_ ;
```

- 3 D code should be used in tool offset mode (G45 to G48). However, H code can be used by setting the parameter TPH (No. 5001#5) because of compatibility with conventional CNC tape format. The H code must be used under tool length offset cancel (G49).
- 4 G45 to G48 are ignored in canned cycle mode. Perform tool offset by specifying G45 to G48 before entering canned cycle mode and cancel the offset after releasing the canned cycle mode.

Examples

**Program**

N1 G91 G46 G00 X80.0 Y50.0 D01 ;

N2 G47 G01 X50.0 F120.0 ;

N3 Y40.0 ;

N4 G48 X40.0 ;

N5 Y-40.0 ;

N6 G45 X30.0 ;

N7 G45 G03 X30.0 Y30.0 J30.0 ;

N8 G45 G01 Y20.0 ;

N9 G46 X0 ;

Decreases toward the positive direction for movement amount "0". The tool moves in the -X direction by the offset value.

N10 G46 G02 X-30.0 Y30.0 J30.0 ;

N11 G45 G01 Y0 ; Increase toward the positive direction for movement amount "0". The tool moves in the +Y direction by the offset value.

N12 G47 X-120.0 ;

N13 G47 Y-80.0 ;

N14 G46 G00 X80.0 Y-50.0 ;

14.4 CUTTER COMPENSATION B (G39 – G42)

When the tool is moved, the tool path can be shifted by the radius of the tool (Fig. 14.4).

To make an offset as large as the radius of the tool, first create an offset vector with a length equal to the radius of the tool (start-up). The offset vector is perpendicular to the tool path. The tail of the vector is on the workpiece side and the head points to the center of the tool.

If a linear interpolation, corner offset, or circular interpolation command is specified after start-up, the tool path can be shifted by the length of the offset vector during machining.

To return the tool to the start point at the end of machining, cancel the cutter compensation mode.

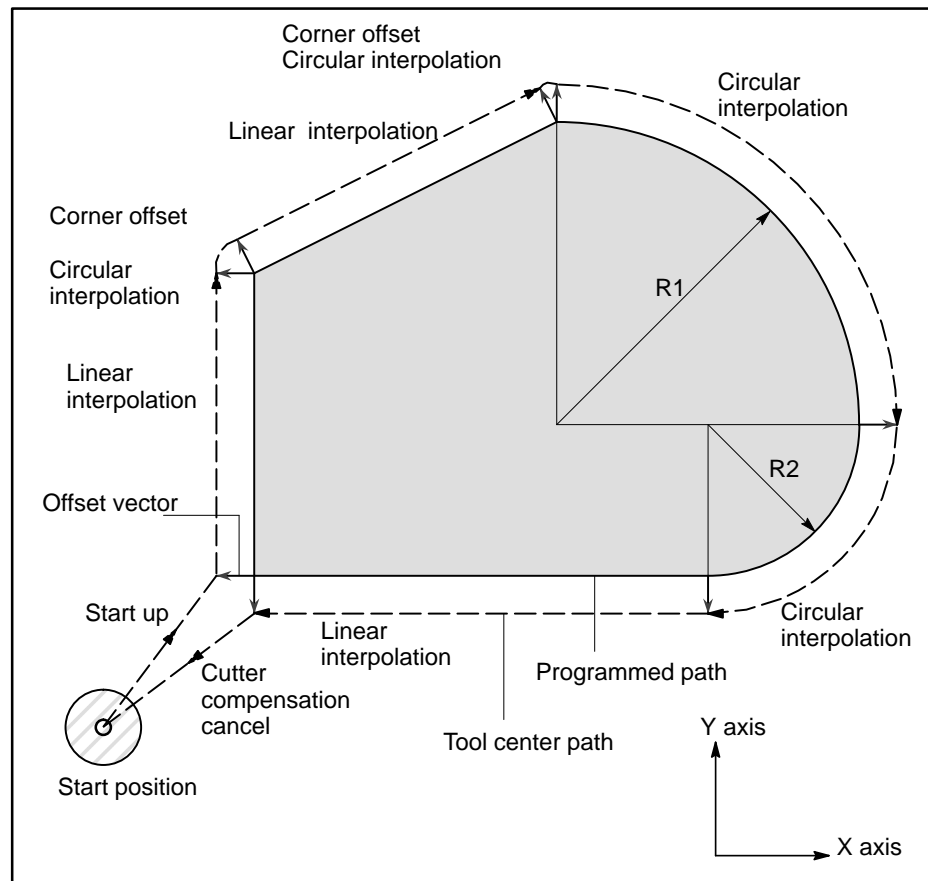


Fig. 14.4 Outline of Cutter Compensation B

Format

- **Start up
(Cutter compensation start)**
- **Corner offset circular interpolation**
- **Cutter compensation cancel**
- **Selection of the offset plane**

G00 (or G01) G41 (or G42) IP_ IR_ H_ ;																	
	G41 : Cutter compensation left (Group 07) G42 : Cutter compensation right (Group 07) IP_ : Command for axis movement IR_ : Incremental value from the end position. Perpendicular to the offset vector at the end position. H_ : Code for specifying the cutter compensation value (1 to 3 digits)																
G39 IP_ (or IR_) ;																	
	G39 : Corner offset circular interpolation (Group 00) IP_ (or IR_) : Incremental value from the end position. Perpendicular to the offset vector at the end position.																
G40 IP_ ;																	
	G40 : Cutter compensation cancel (Group 07) IP_ : Command for axis movement																
	<table border="1"> <thead> <tr> <th>Offset plane</th> <th>Command of the plane selection</th> <th>IP_</th> <th>IR_</th> </tr> </thead> <tbody> <tr> <td>XpYp</td> <td>G17 ;</td> <td>Xp_Yp_</td> <td>I_J_</td> </tr> <tr> <td>ZpXp</td> <td>G18 ;</td> <td>Xp_Zp_</td> <td>I_K_</td> </tr> <tr> <td>YpZp</td> <td>G19 ;</td> <td>Yp_Zp_</td> <td>J_K_</td> </tr> </tbody> </table>	Offset plane	Command of the plane selection	IP_	IR_	XpYp	G17 ;	Xp_Yp_	I_J_	ZpXp	G18 ;	Xp_Zp_	I_K_	YpZp	G19 ;	Yp_Zp_	J_K_
Offset plane	Command of the plane selection	IP_	IR_														
XpYp	G17 ;	Xp_Yp_	I_J_														
ZpXp	G18 ;	Xp_Zp_	I_K_														
YpZp	G19 ;	Yp_Zp_	J_K_														

Explanations

- **H code**

Specify the number assigned to a cutter compensation value with a 1– to 3–digit number after address H (H code) in the program. The H code can be specified in any position before the offset cancel mode is first switched to the cutter compensation mode. The H code need not be specified again unless the cutter compensation value needs to be changed.

Assign cutter compensation values to the H codes on the MDI panel. For the specification of the cutter compensation value, see III–11.4.1 in the section on operation.

The table below shows the range in which the cutter compensation values can be specified.

Table14.4 Valid range of cutter compensation values

	Metric input	inch input
Cutter compensation value	0 to ±999.999mm	0 to ±99.9999inch

NOTE

The cutter compensation value corresponding to offset No.0, that is, H0 always gets 0. It is impossible to set H0 to any other cutter compensation value.

- **Offset plane selection and offset vector**

Cutter compensation is carried out in the plane determined by G17, G18 and G19 (G codes for plane selection.). This plane is called the offset plane. If the offset plane is not specified, G17 is assumed to be programmed.

Compensation is not executed for the coordinates of a position which is not in the specified plane. The programmed values are used as they are. In the sequel, what vector is created, what offset calculation is made, by an offset command, will be discussed on assumption that an XY plane is selected. This discussion applies also when another plane is selected.

The offset vector is cleared by reset.

After the power is turned on, the length of the offset vector is set to zero and the cutter compensation cancel mode is selected.

Notes

- **Transition from the offset cancel mode to the cutter compensation mode (Start up)**

NOTE

A move command mode at the time of change from the offset cancel mode to the cutter compensation mode, is positioning (G00) or linear interpolation (G01). The circular interpolation (G02, G03) cannot be used.

14.4.1 Cutter Compensation Left (G41)

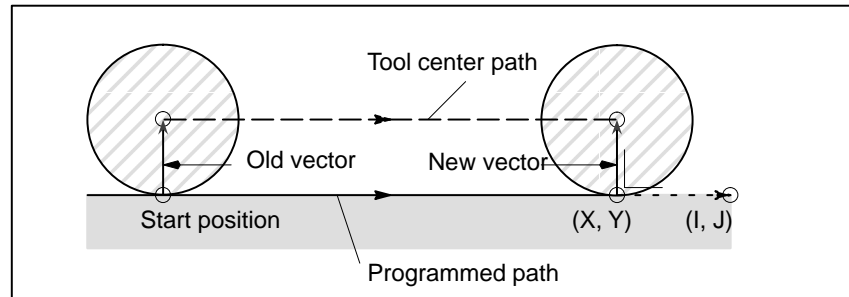
G41 offsets the tool towards the left of the workpiece as you see when you face in the same direction as the movement of the cutting tool.

Explanations

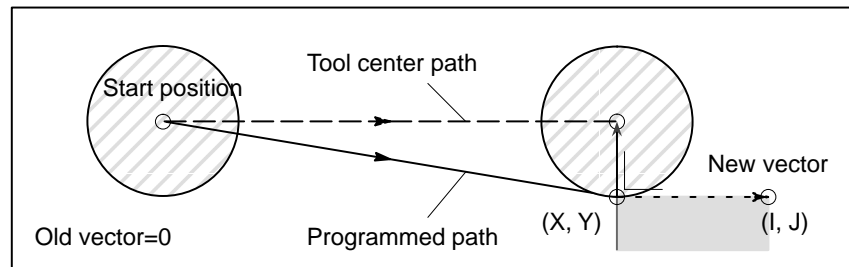
- **G00 (positioning) or G01 (linear interpolation)**

G41 X_Y_I_J_H_;

specifies a new vector to be created at right angles with the direction of (I, J) on the end point, and the tool center moves toward the point of the new vector from that of the old vector on the start point. (I, J) is expressed in an incremental value from the end point, and is significant only as a direction, and its amount is arbitrary.



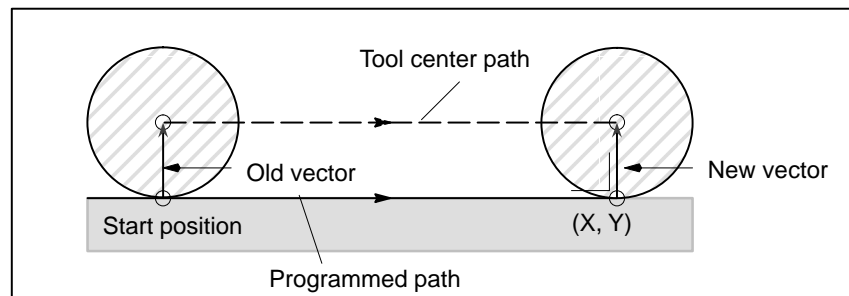
In case the old vector is 0, this command specifies the equipment to enter from the cancel mode into the cutter compensation mode. At this time, the offset number is specified by the H code.



Unless otherwise specified, (I, J) are assumed to be equal to (X, Y). When the following command is specified, a vector perpendicular to a line connecting the start position and position (X, Y) is created.

G41 X_Y_;

If, however, G00 is specified, each axis moves independently at the rapid traverse rate.



- **G02, G03**
(Circular interpolation)

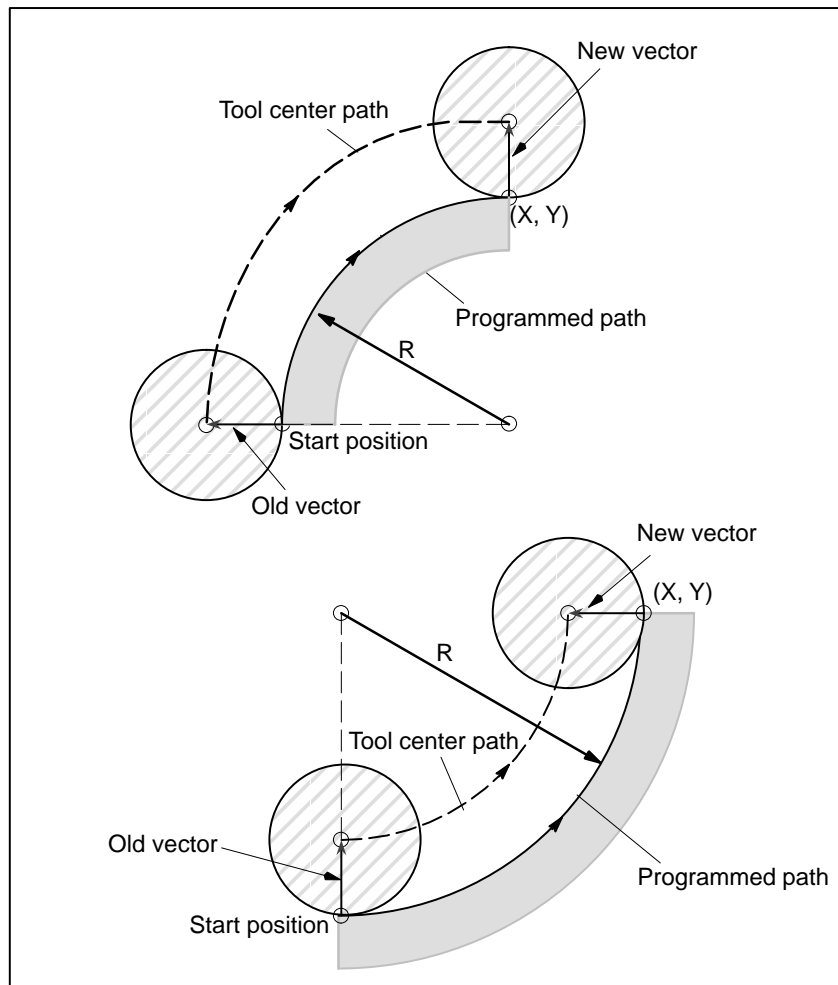
G41... ;

:

G02 (or G03) X_ Y_ R_ ;

Above command specifies a new vector to be created to the left looking toward the direction in which an arc advances on a line connecting the arc center and the arc end point, and the tool center to move along the arc advancing from the point of the old vector on the arc start point toward that of the new vector. This is, however, established on assumption the old vector is created correctly.

The offset vector is created toward the arc center or opposite direction against the arc center.



14.4.2 Cutter Compensation Right (G42)

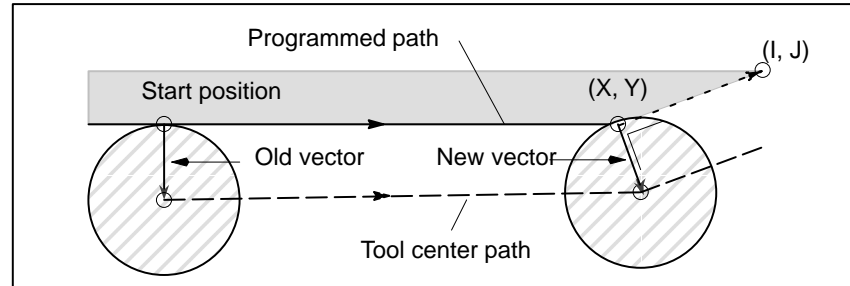
G42, contrary to G41, specifies a tool to be offset to the right of work piece looking toward the direction in which the tool advances.

G42 has the same function as G41, except that the directions of the vectors created by the commands are the opposite.

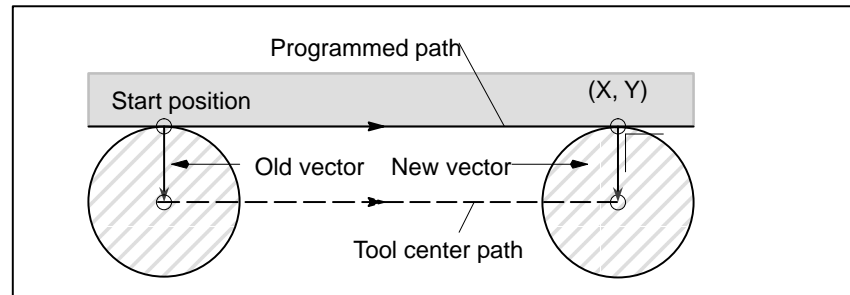
Explanations

- G00(positioning)or
G01(linear interpolation)

G42 X_ Y_ I_ J_ H_ ;



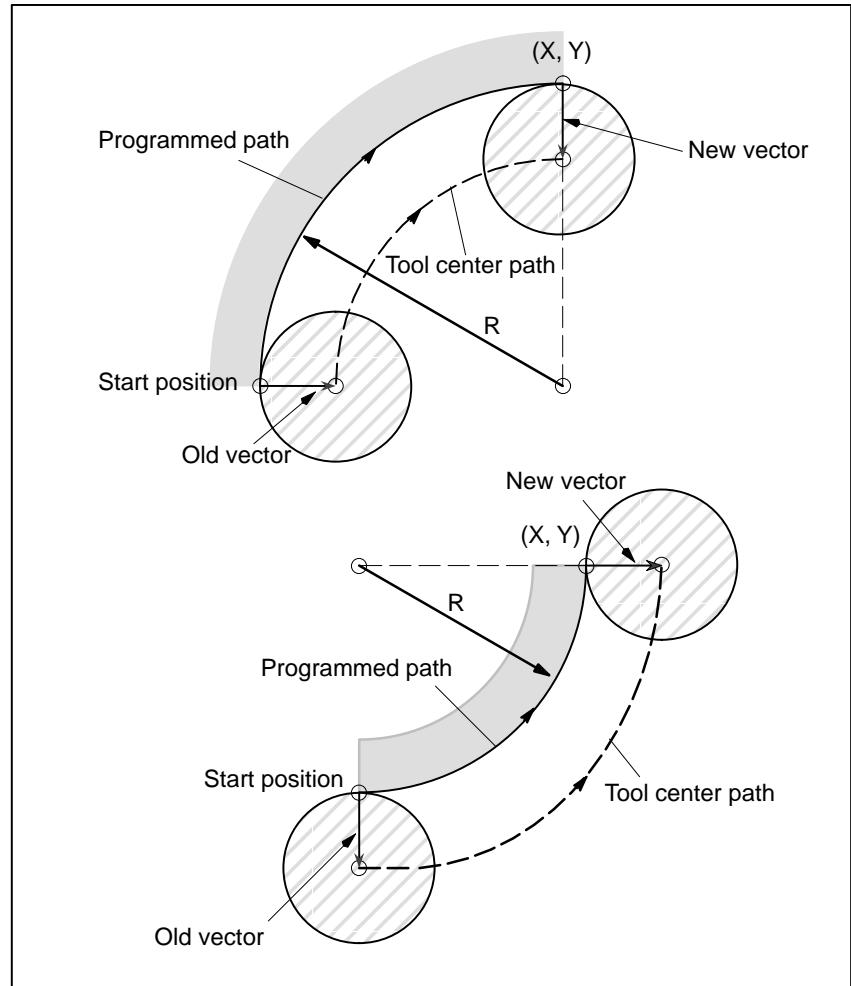
G42 X_ Y_ ;



In the case of G00, however, each axis moves independently at the rapid traverse rate.

• **G02 or G03**
(Circular interpolation)

G42... ;
:
G02 (or G03) X_ Y_ R_;



14.4.3 Corner Offset Circular Interpolation (G39)

When the following command is specified in the G01, G02, or G03 mode, corner offset circular interpolation can be executed with respect to the radius of the tool.

Format

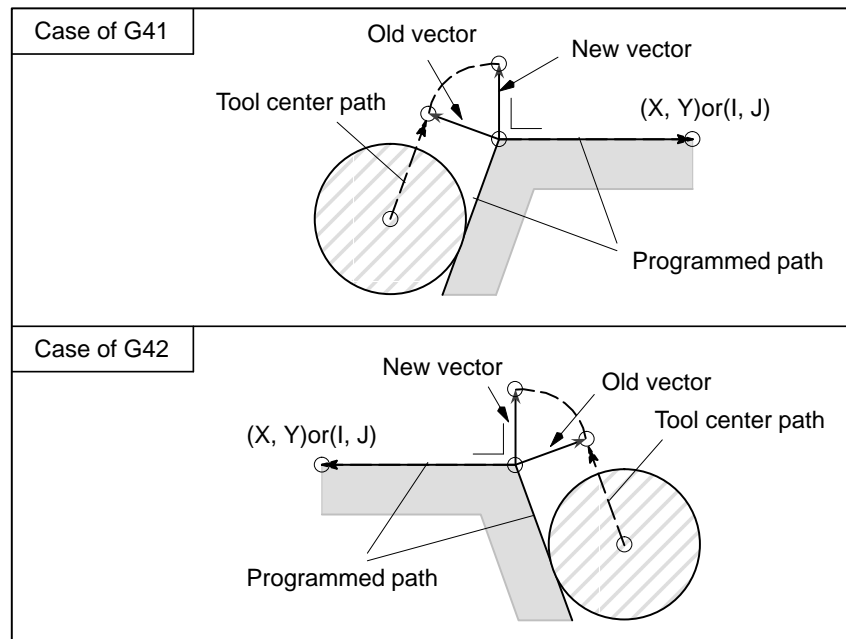
In offset mode

$$G39 \left\{ \begin{array}{l} X_Y_ \\ X_Z_ \\ Y_Z_ \end{array} \right\} ;$$

or

$$G39 \left\{ \begin{array}{l} I_J_ \\ I_K_ \\ J_K_ \end{array} \right\} ;$$

A new vector is created to the left (G41) or to the right (G42) looking toward (X, Y) from the end point at right angles therewith, and the tool moves along the arc from the point of the old vector toward that of the new vector. (X, Y, Z) is expressed in a value according to the G90/G91 respectively. (I, J, K) is expressed in an incremental value from the end point.

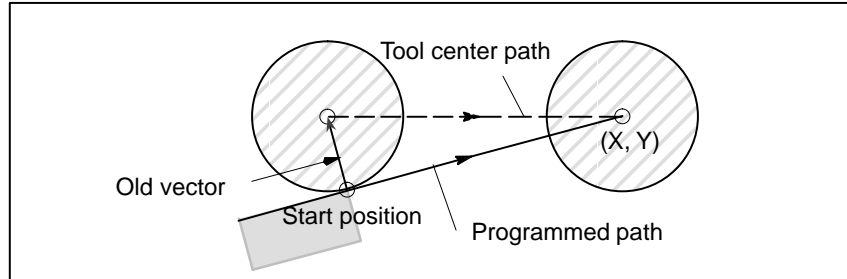


This command can be given in offset mode, that is, only when G41 or G42 has already been specified. Whether the arc is to turn clockwise or counterclockwise, is defined by G41 or G42, respectively. This command is not modal, and executes circular interpolation, whatever the G function of group 01 may be. The G function of group 01 remains even though this command is specified.

14.4.4 Cutter Compensation Cancel (G40)

When the following command is specified in the G00 or G01 mode, the tool moves from the head of the old vector at the start position to the end position (X, Y). In the G01 mode, the tool moves linearly. In the G00 mode, rapid traverse is carried out along each axis.

G40 X_ Y_ ;



This command changes the mode of the equipment from the cutter compensation mode to the cancel mode.

When only G40; is specified, and X_ Y_ is not specified, the tool moves by the old vector amount in the opposite direction.

NOTE

Cutter compensation cannot be canceled in the circular interpolation (G02, G03) mode.

14.4.5 Switch between Cutter Compensation Left and Cutter Compensation Right

The offset direction is switched from left to right, or from right to left generally through the offset cancel mode, but can be switched not through it only in positioning (G00) or linear interpolation (G01). In this case, the tool path is as shown in Fig 14.4.5.

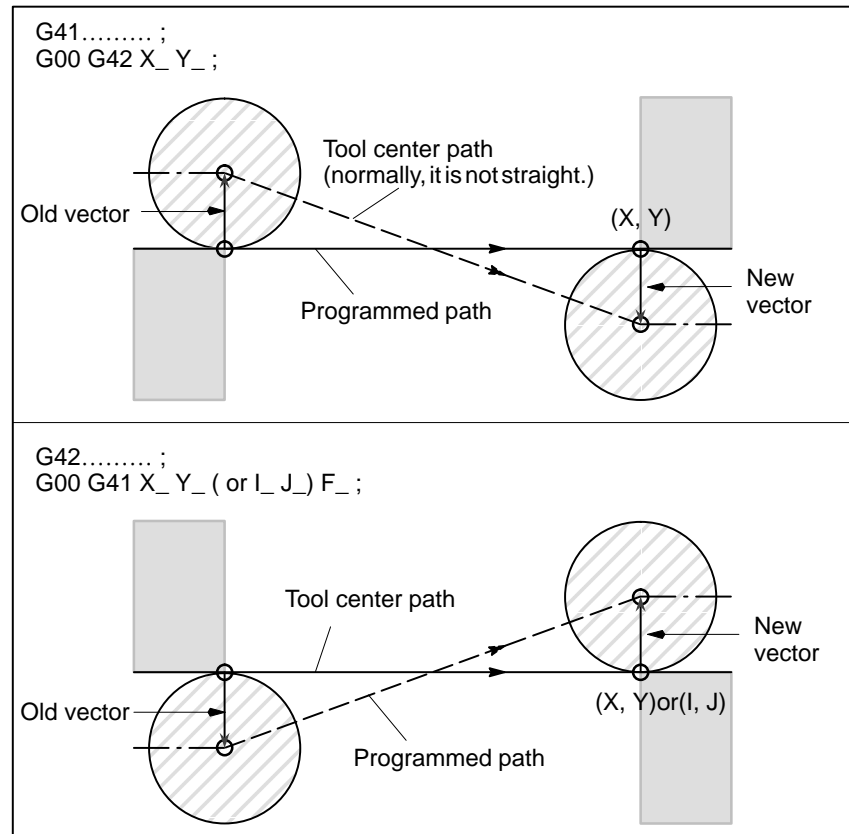


Fig. 14.4.5 Switching the Direction of Cutter Compensation

14.4.6 Change of the Cutter Compensation Value

The offset amount is changed generally when the tool is changed in the offset cancel mode, but can be changed in the offset mode only in positioning (G00) or linear interpolation (G01).

Program as described below:

G00 (or G01) X_ Y_ H_ ; (H_ indicates the number of a new cutter compensation value.)

Fig. 14.4.6 shows how the tool is moved when the change in compensation is specified.

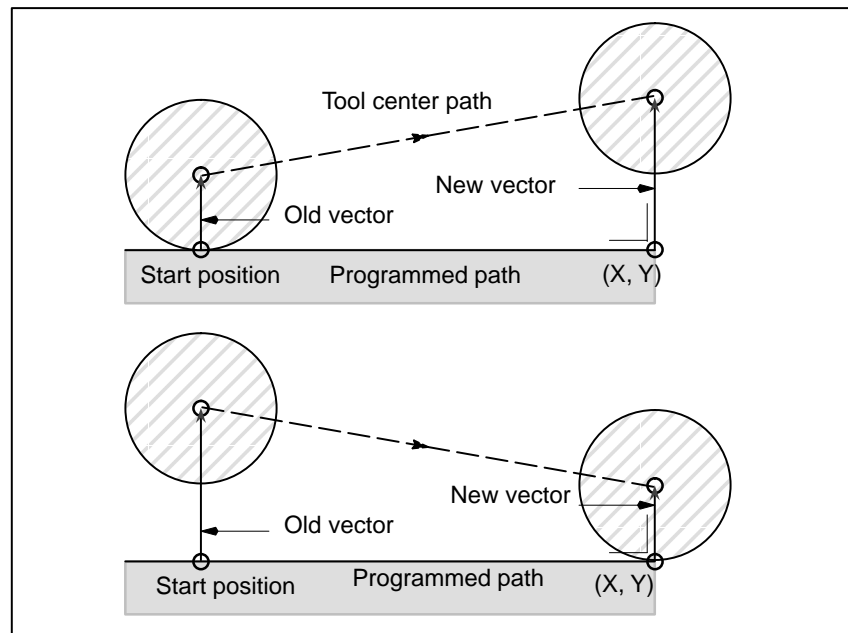


Fig 14.4.6 Change of the cutter compensation value in offset mode

14.4.7 Positive/Negative Cutter Compensation Value and Tool Center Path

If the tool compensation value is made negative ($-$), it is equal that G41 and G42 are replaced with each other in the process sheet. Consequently, if the tool center is passing around the outside of the workbench it will pass around the inside thereof, and vice versa.

Fig. 14.4.7 shows one example. Generally speaking, the cutter compensation value shall be programmed to be positive ($+$). When a tool path is programmed as shown in (1), if the cutter compensation value is made negative ($-$), the tool center moves as shown in (2).

If the cutter compensation value is changed to a negative value when tool path (2) shown in Fig. 14.4.7 is programmed, the tool follows tool path (1) shown in the same figure.

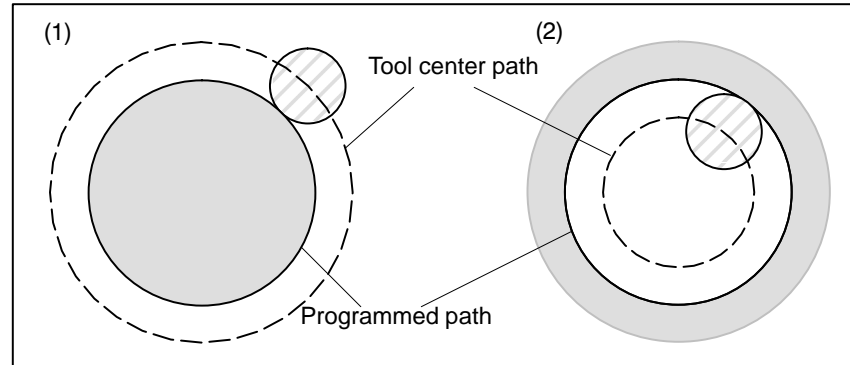


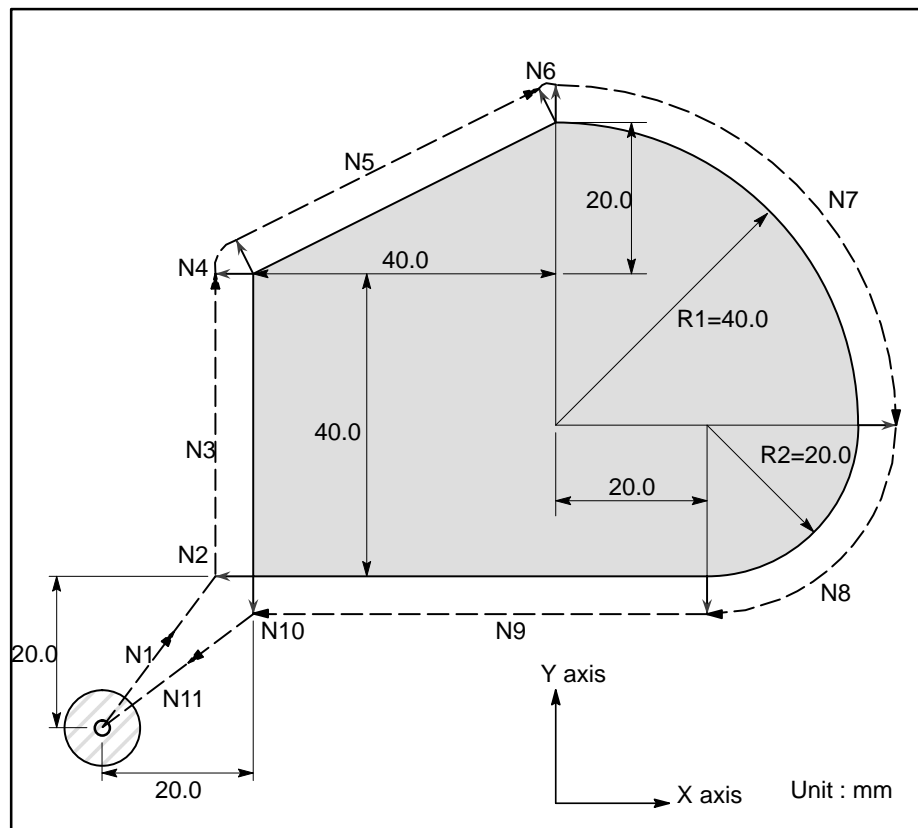
Fig. 14.4.7 Tool Center Paths when Positive and Negative Cutter Compensation Values are Specified

For a cornered figure (involved in corner circular interpolation) in general, the cutter compensation value naturally cannot be made negative ($-$) to cut the inside. In order to cut the inside corner of a cornered figure, an arc with an appropriate radius must be inserted there to provide smooth cutting.

WARNING

If the tool length offset is commanded during cutter compensation, the offset amount of cutter compensation is also regarded to have been changed.

Examples



```

N1 G91 G17 G00 G41 X20.0 Y20.0 H08 ;
N2 G01 Z-25.0 F100 ;
N3 Y40.0 F250 ;
N4 G39 I40.0 J20.0 ;
N5 X40.0 Y20.0 ;
N6 G39 I40.0 ;
N7 G02 X40.0 Y-40.0 R40.0 ;
N8 X-20.0 Y-20.0 R20.0 ;
N9 G01 X-60.0 ;
N10 G00 Z25.0 ;
N11 G40 X-20.0 Y-20.0 M02 ;

```

(H08 is a tool offset number, and the cutter radius value should be stored in the memory corresponding to this number).

14.5 OVERVIEW OF CUTTER COMPENSATION C (G40 – G42)

When the tool is moved, the tool path can be shifted by the radius of the tool (Fig. 14.5 (a)).

To make an offset as large as the radius of the tool, CNC first creates an offset vector with a length equal to the radius of the tool (start-up). The offset vector is perpendicular to the tool path. The tail of the vector is on the workpiece side and the head positions to the center of the tool.

If a linear interpolation or circular interpolation command is specified after start-up, the tool path can be shifted by the length of the offset vector during machining.

To return the tool to the start position at the end of machining, cancel the cutter compensation mode.

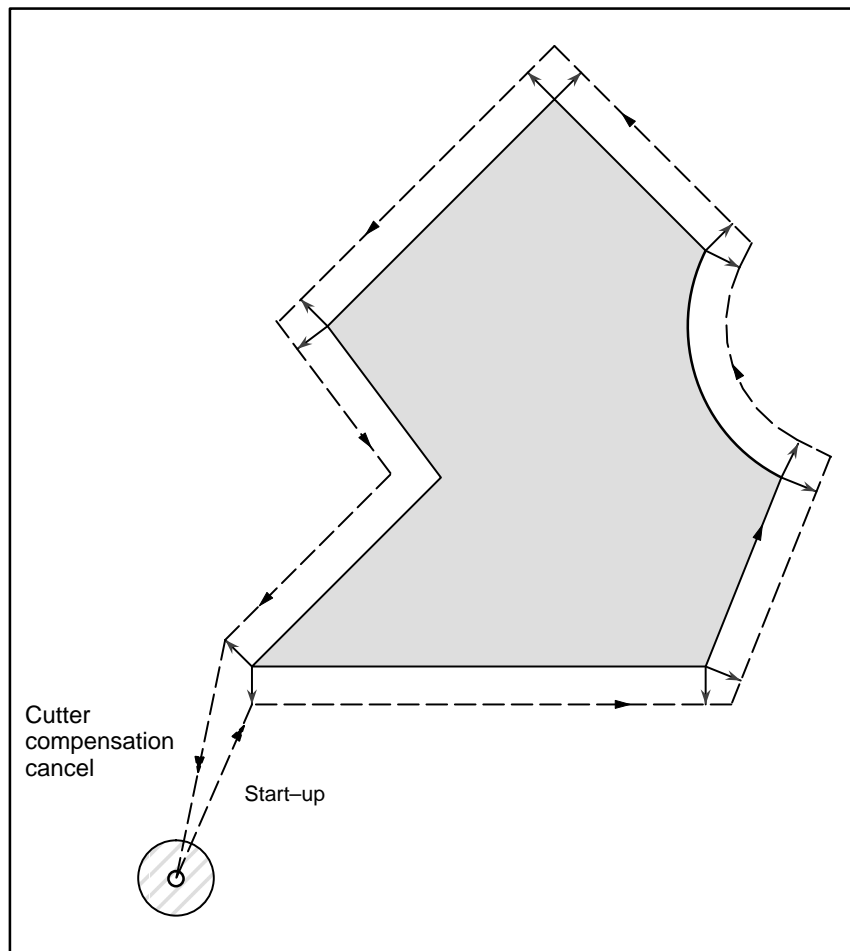


Fig. 14.5 (a) Outline of Cutter Compensation C

Format

- **Start up
(Tool compensation start)**

G00(or G01)G41(or G42) IP_ D_ ;
G41 : Cutter compensation left (Group07) G42 : Cutter compensation right (Group07) IP_ : Command for axis movement D_ : Code for specifying as the cutter compensation value(1-3digits) (D code)

- **Cutter compensation cancel
(offset mode cancel)**

G40 ;
G40 : Cutter compensation cancel(Group 07) (Offset mode cancel) IP_ : Command for axis movement

- **Selection of the offset plane**

Offset plane	Command for plane selection	IP_
XpYp	G17 ;	Xp_Yp_
ZpXp	G18 ;	Xp_Zp_
YpZp	G19 ;	Yp_Zp_

Explanations

- **Offset cancel mode**

At the beginning when power is applied the control is in the cancel mode. In the cancel mode, the vector is always 0, and the tool center path coincides with the programmed path.

- **Start Up**

When a cutter compensation command (G41 or G42, nonzero dimension words in the offset plane, and D code other than D0) is specified in the offset cancel mode, the CNC enters the offset mode.

Moving the tool with this command is called start-up.

Specify positioning (G00) or linear interpolation (G01) for start-up. If circular interpolation (G02, G03) is specified, P/S alarm 34 occurs.

When processing the start-up block and subsequent blocks, the CNC prereads two blocks.

- **Offset mode**

In the offset mode, compensation is accomplished by positioning (G00), linear interpolation (G01), or circular interpolation (G02, G03). If two or more blocks that do not move the tool (miscellaneous function, dwell, etc.) are processed in the offset mode, the tool will make either an excessive or insufficient cut. If the offset plane is switched in the offset mode, P/S alarm 37 occurs and the tool is stopped.

- **Offset mode cancel**

In the offset mode, when a block which satisfies any one of the following conditions is executed, the CNC enters the offset cancel mode, and the action of this block is called the offset cancel.

1. **G40 has been commanded.**
2. **0 has been commanded as the offset number for cutter compensation.**

When performing offset cancel, circular arc commands (G02 and G03) are not available. If a circular arc is commanded, an P/S alarm (No. 034) is generated and the tool stops.

In the offset cancel, the control executes the instructions in that block and the block in the cutter compensation buffer. In the meantime, in the case of a single block mode, after reading one block, the control executes it and stops. By pushing the cycle start button once more, one block is executed without reading the next block.

Then the control is in the cancel mode, and normally, the block to be executed next will be stored in the buffer register and the next block is not read into the buffer for cutter compensation.

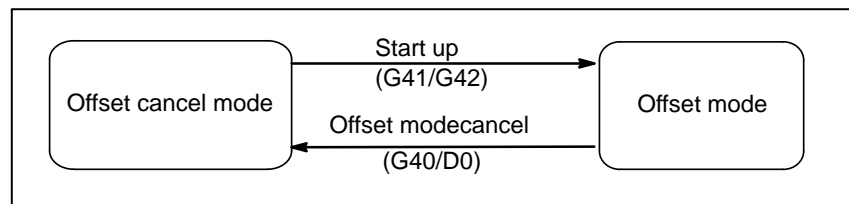


Fig. 14.5 (b) Changing the offset mode

- **Change of the Cutter compensation value**

In general, the cutter compensation value shall be changed in the cancel mode, when changing tools. If the cutter compensation value is changed in offset mode, the vector at the end point of the block is calculated for the new cutter compensation value.

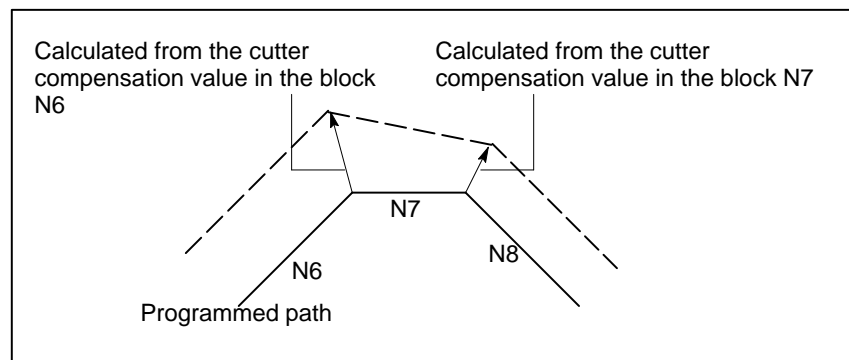


Fig. 14.5 (c) Changing the Cutter Compensation Value

- **Positive/negative cutter compensation value and tool center path**

If the offset amount is negative (–), distribution is made for a figure in which G41's and G42's are all replaced with each other on the program. Consequently, if the tool center is passing around the outside of the workpiece, it will pass around the inside, and vice versa.

The figure below shows one example. Generally, the offset amount is programmed to be positive (+).

When a tool path is programmed as in ((1)), if the offset amount is made negative (–), the tool center moves as in ((2)), and vice versa. Consequently, the same tape permits cutting both male and female shapes, and any gap between them can be adjusted by the selection of the offset amount. Applicable if start-up and cancel is A type. (See II- 14.6.2 and 14.6.4)

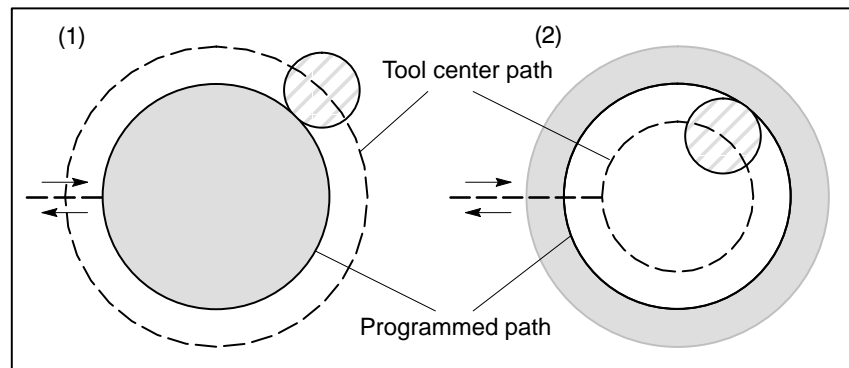


Fig. 14.5 (d) Tool Center Paths when Positive and Negative Cutter Compensation Values are Specified

- **Cutter compensation value setting**

Assign a cutter compensation values to the D codes on the MDI panel. The table below shows the range in which cutter compensation values can be specified.

	mm input	inch input
Cutter compensation value	0 to ±999.999mm	0 to ±99.9999inch

NOTE

- 1 The cutter compensation value corresponding to offset No. 0, that is, D0 always means 0. It is impossible to set D0 to any other offset amount.
- 2 Cutter compensation C can be specified by H code with parameter OFH (No. 5001 #2) set to 1.

- **Offset vector**

The offset vector is the two dimensional vector that is equal to the cutter compensation value assigned by D code. It is calculated inside the control unit, and its direction is up-dated in accordance with the progress of the tool in each block.

The offset vector is deleted by reset.

- **Specifying a cutter compensation value**

Specify a cutter compensation value with a number assigned to it. The number consists of 1 to 3 digits after address D (D code). The D code is valid until another D code is specified. The D code is used to specify the tool offset value as well as the cutter compensation value.

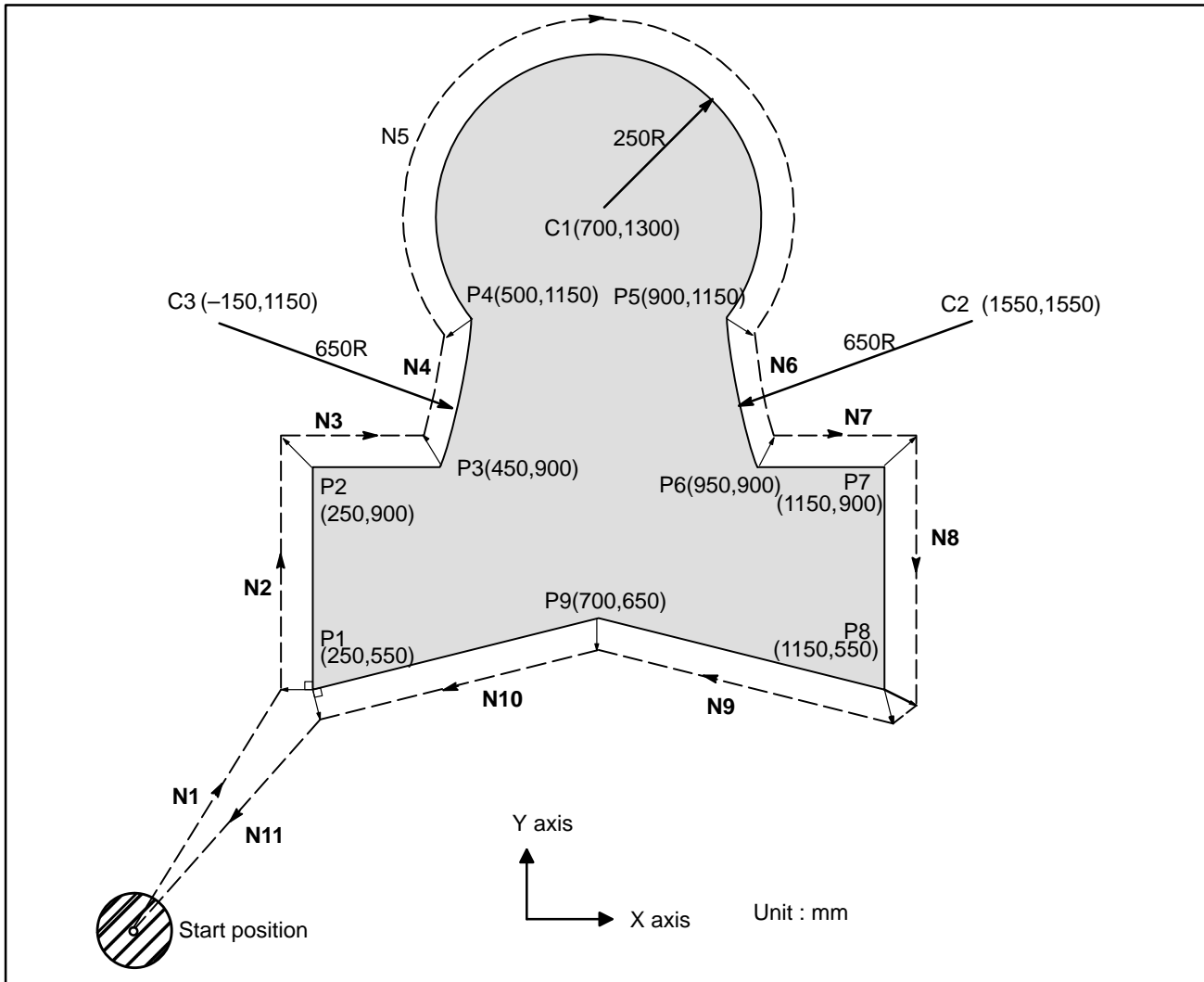
- **Plane selection and vector**

Offset calculation is carried out in the plane determined by G17, G18 and G19, (G codes for plane selection). This plane is called the offset plane. Compensation is not executed for the coordinate of a position which is not in the specified plane. The programmed values are used as they are.

In simultaneous 3 axes control, the tool path projected on the offset plane is compensated.

The offset plane is changed during the offset cancel mode. If it is performed during the offset mode, a P/S alarm (No. 37) is displayed and the machine is stopped.

Examples



- G92 X0 Y0 Z0 ;** Specifies absolute coordinates.
The tool is positioned at the start position (X0, Y0, Z0).
- N1 G90 G17 G00 G41 D07 X250.0 Y550.0 ;** Starts cutter compensation (start-up). The tool is shifted to the left of the programmed path by the distance specified in D07. In other words the tool path is shifted by the radius of the tool (offset mode) because D07 is set to 15 beforehand (the radius of the tool is 15 mm).
- N2 G01 Y900.0 F150 ;** Specifies machining from P1 to P2.
- N3 X450.0 ;** Specifies machining from P2 to P3.
- N4 G03 X500.0 Y1150.0 R650.0 ;** Specifies machining from P3 to P4.
- N5 G02 X900.0 R-250.0 ;** Specifies machining from P4 to P5.
- N6 G03 X950.0 Y900.0 R650.0 ;** Specifies machining from P5 to P6.
- N7 G01 X1150.0 ;** Specifies machining from P6 to P7.
- N8 Y550.0 ;** Specifies machining from P7 to P8.
- N9 X700.0 Y650.0 ;** Specifies machining from P8 to P9.
- N10 X250.0 Y550.0 ;** Specifies machining from P9 to P1.
- N11 G00 G40 X0 Y0 ;** Cancels the offset mode.
The tool is returned to the start position (X0, Y0, Z0).

14.6 DETAILS OF CUTTER COMPENSATION C

This section provides a detailed explanation of the movement of the tool for cutter compensation C outlined in Section 14.5.

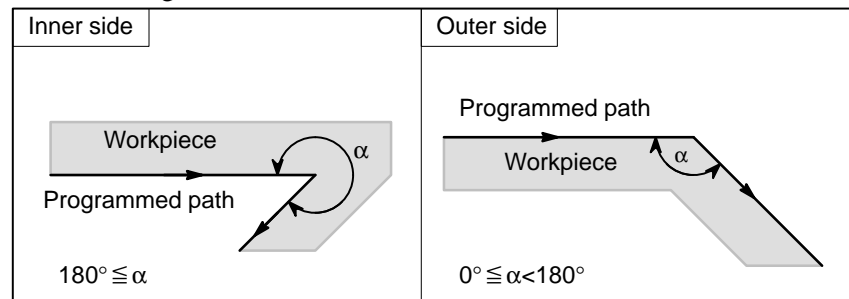
This section consists of the following subsections:

- 14.6.1 General
- 14.6.2 Tool Movement in Start-up
- 14.6.3 Tool Movement in Offset Mode
- 14.6.4 Tool Movement in Offset Mode Cancel
- 14.6.5 Interference Check
- 14.6.6 Over cutting by Cutter Compensation
- 14.6.7 Input command from MDI
- 14.6.8 G53,G28,G30 and G29 commands in cutter compensation C mode
- 14.6.9 Corner Circular Interpolation (G39)

14.6.1 General

- Inner side and outer side

When an angle of intersection created by tool paths specified with move commands for two blocks is over 180° , it is referred to as “inner side.” When the angle is between 0° and 180° , it is referred to as “outer side.”



- Meaning of symbols

The following symbols are used in subsequent figures:

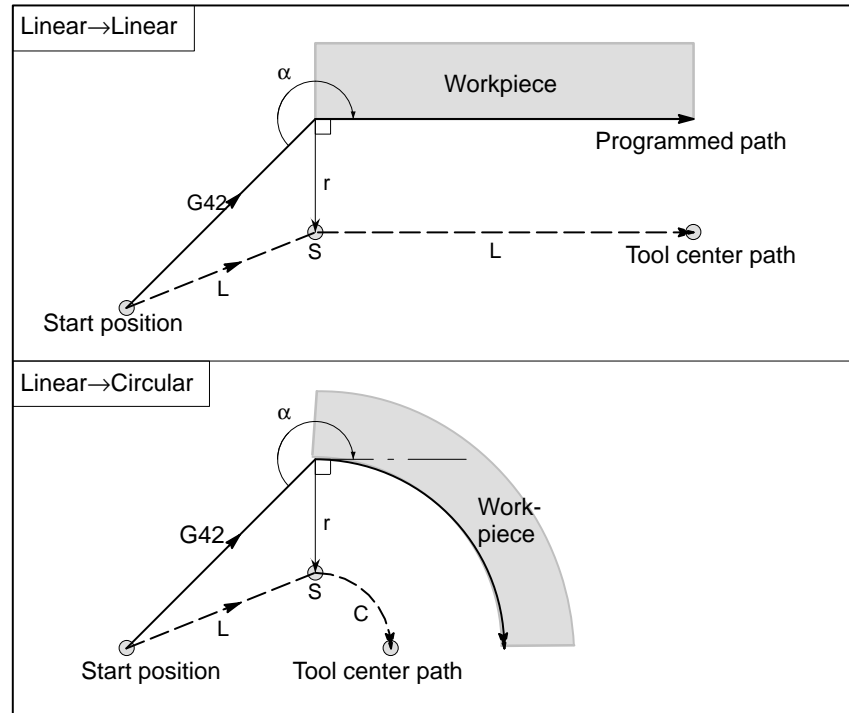
- *S* indicates a position at which a single block is executed once.
- *SS* indicates a position at which a single block is executed twice.
- *SSS* indicates a position at which a single block is executed three times.
- *L* indicates that the tool moves along a straight line.
- *C* indicates that the tool moves along an arc.
- *r* indicates the cutter compensation value.
- An intersection is a position at which the programmed paths of two blocks intersect with each other after they are shifted by *r*.
- \odot indicates the center of the tool.

14.6.2 Tool Movement in Start-up

When the offset cancel mode is changed to offset mode, the tool moves as illustrated below (start-up):

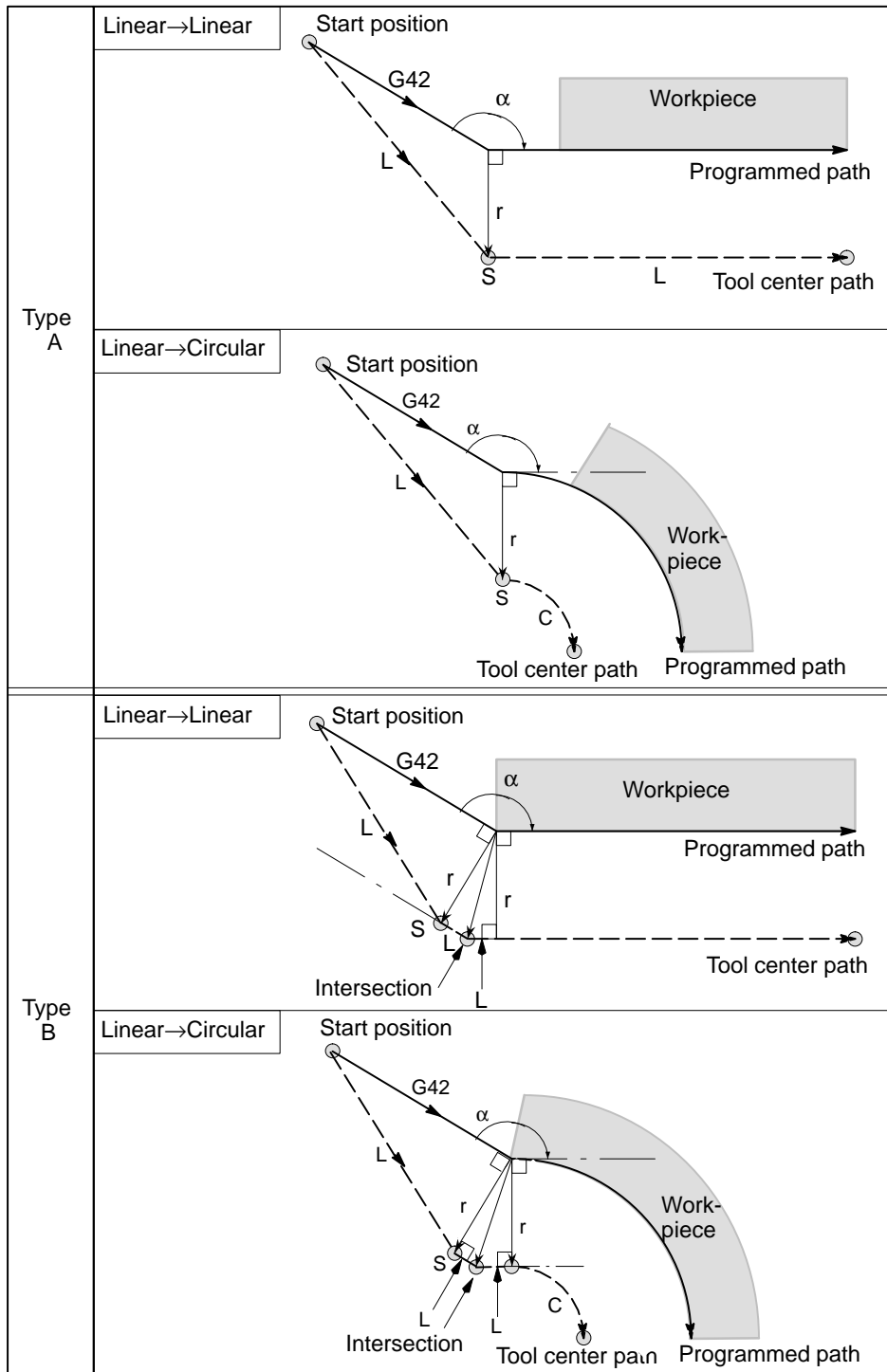
Explanations

- Tool movement around an inner side of a corner ($180^\circ \cong \alpha$)



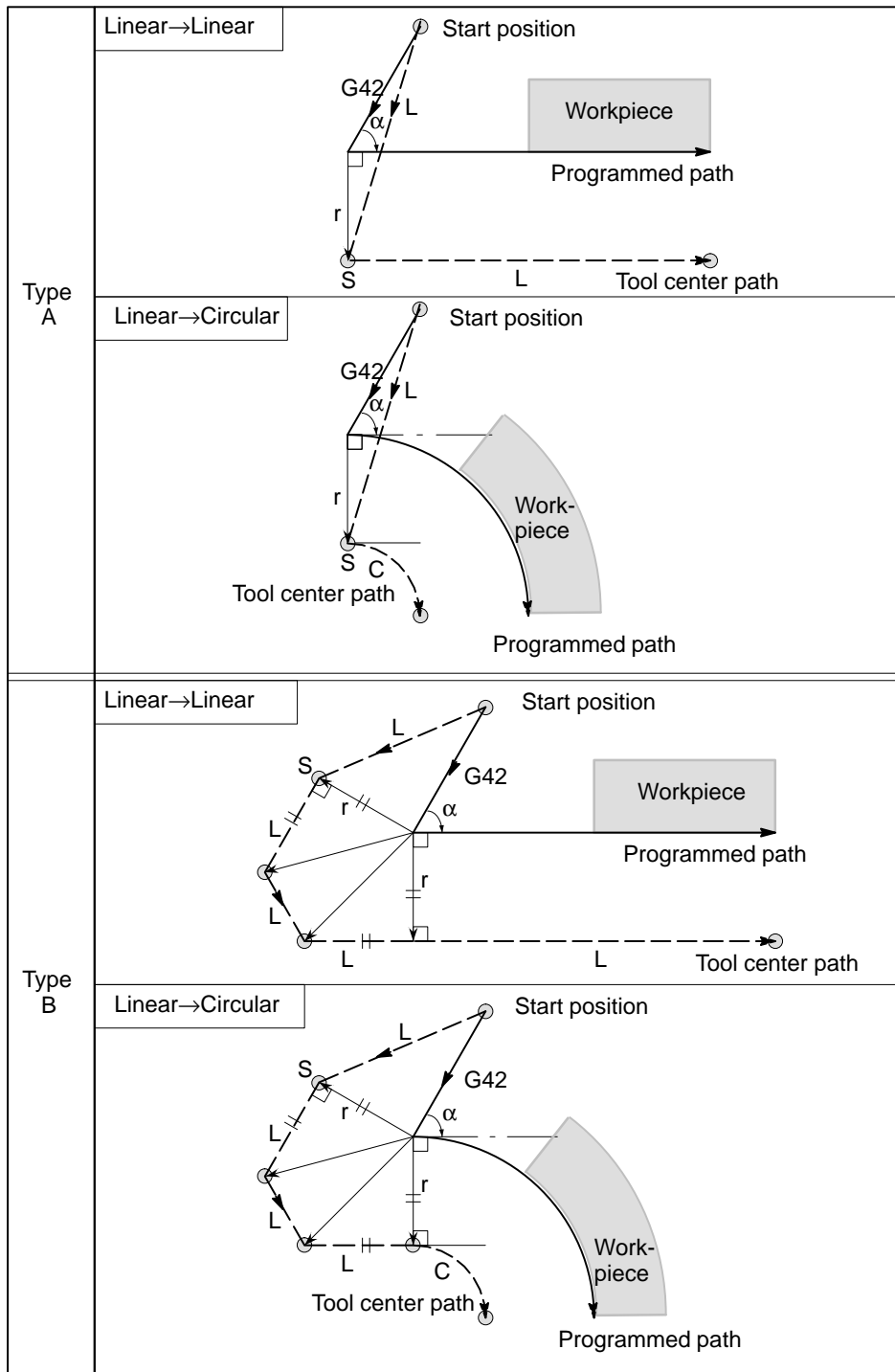
- **Tool movement around the outside of a corner at an obtuse angle ($90^\circ \leq \alpha < 180^\circ$)**

Tool path in start-up has two types A and B, and they are selected by parameter SUP (No. 5003#0).

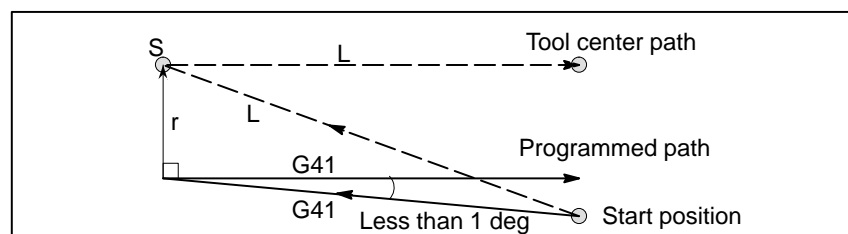


- **Tool movement around the outside of an acute angle ($\alpha < 90^\circ$)**

Tool path in start-up has two types A and B, and they are selected by parameter SUP (No.5003#0).

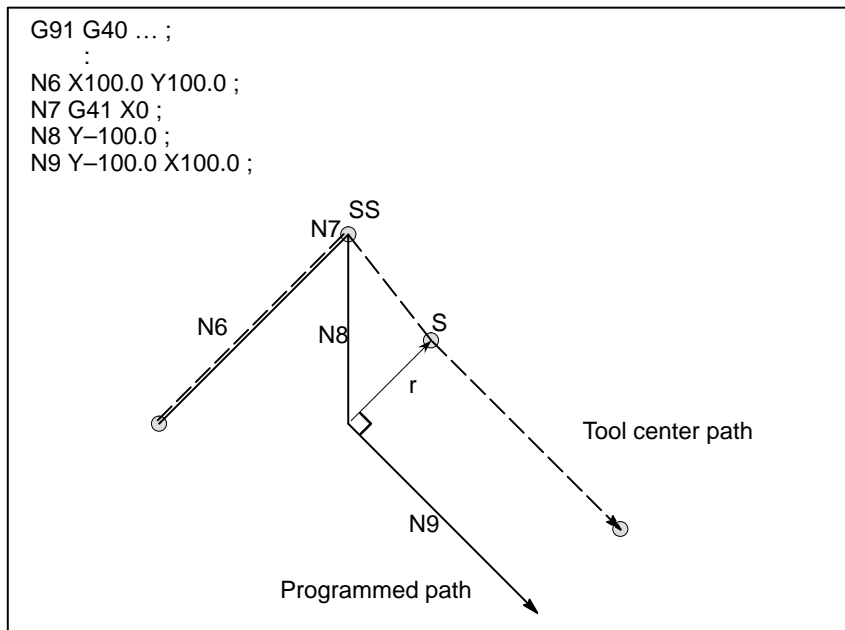


- **Tool movement around the outside linear→linear at an acute angle less than 1 degree ($\alpha < 1^\circ$)**



- **A block without tool movement specified at start-up**

If the command is specified at start-up, the offset vector is not created.

**NOTE**

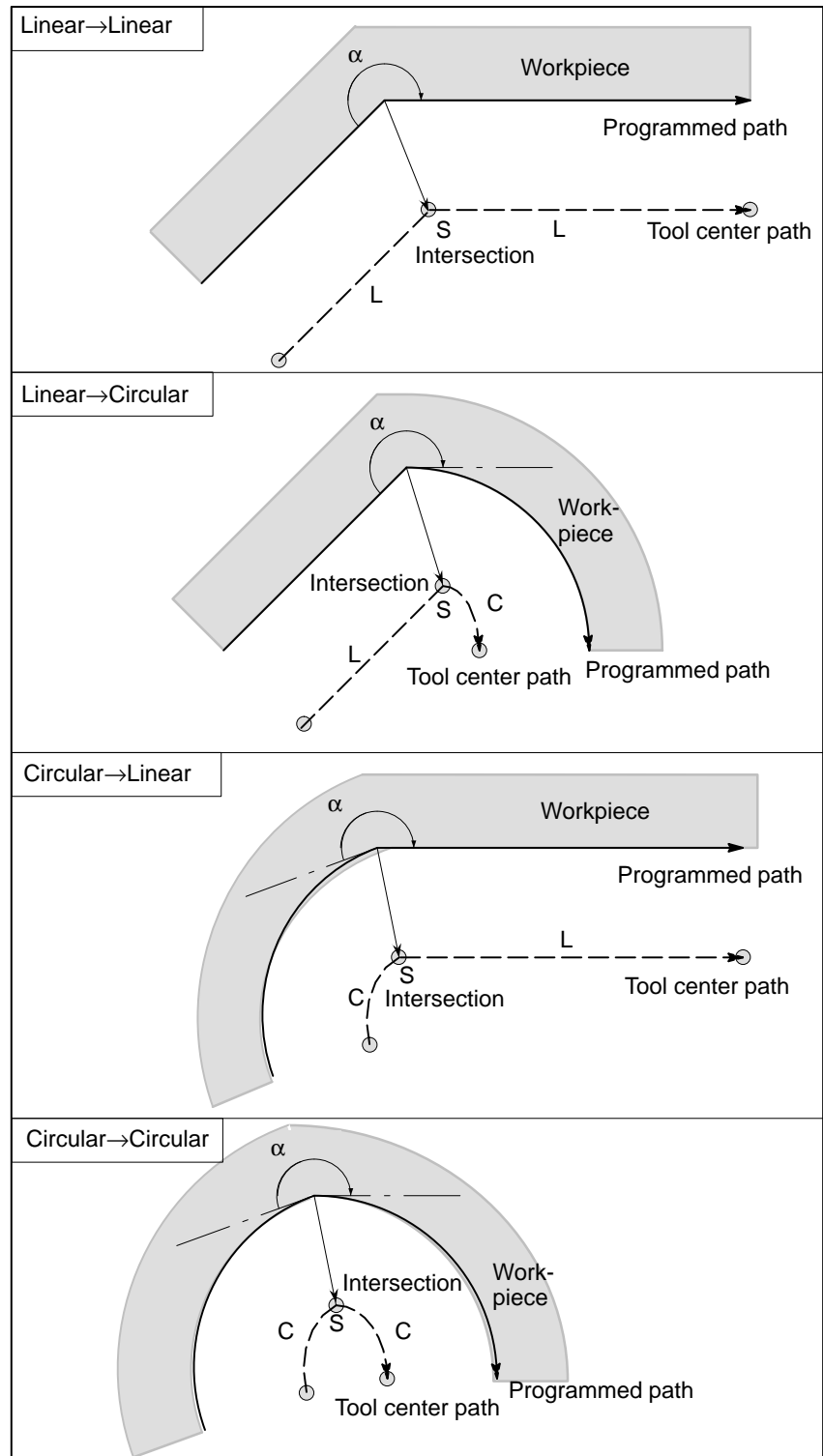
For the definition of blocks that do not move the tool, see II-14.6.3.

14.6.3 Tool Movement in Offset Mode

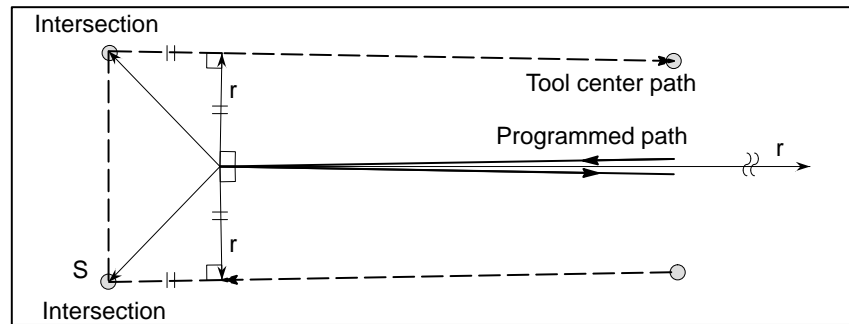
In the offset mode, the tool moves as illustrated below:

Explanations

- Tool movement around the inside of a corner ($180^\circ \leq \alpha$)

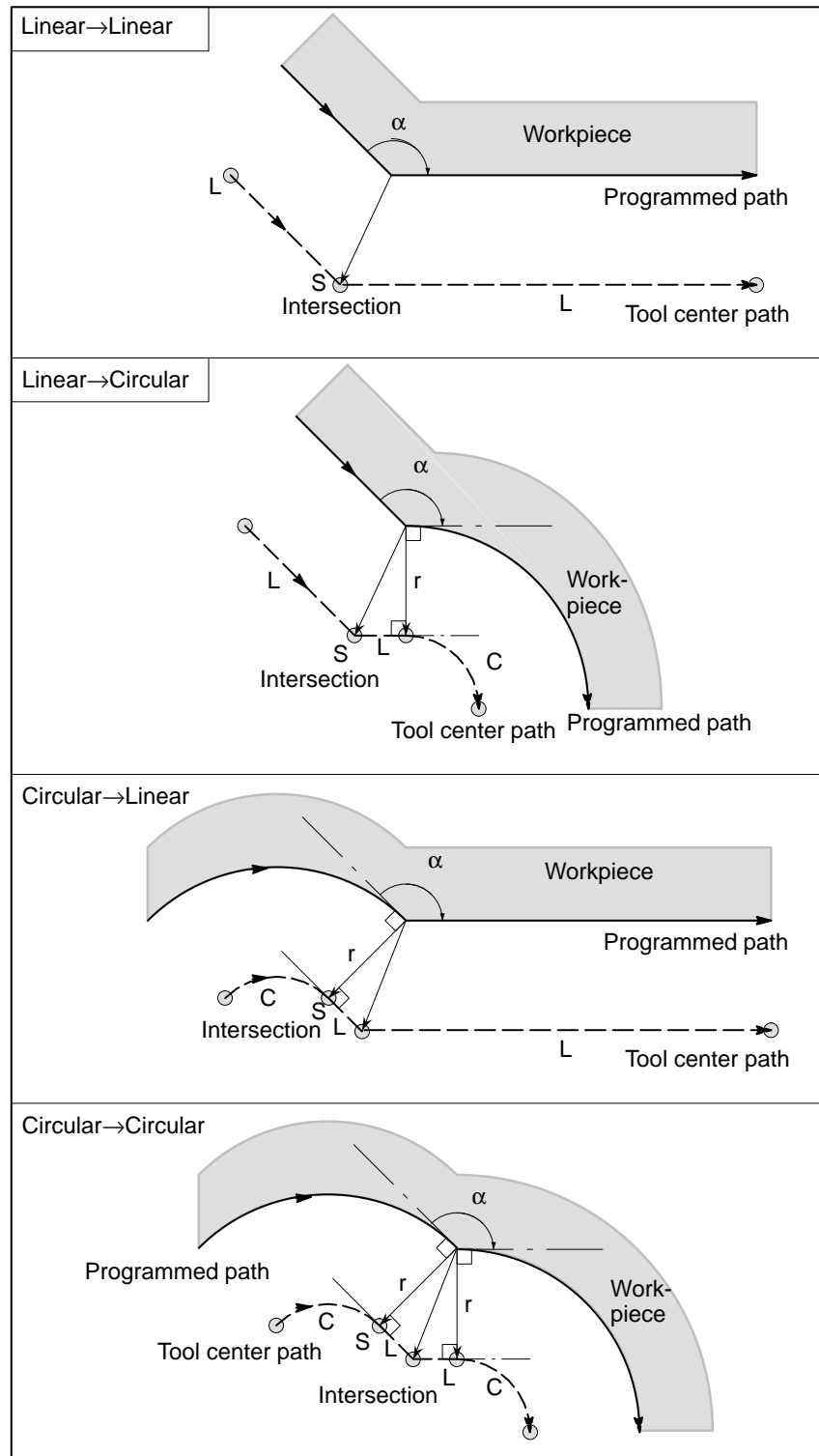


- **Tool movement around the inside ($\alpha < 1^\circ$) with an abnormally long vector, linear \rightarrow linear**

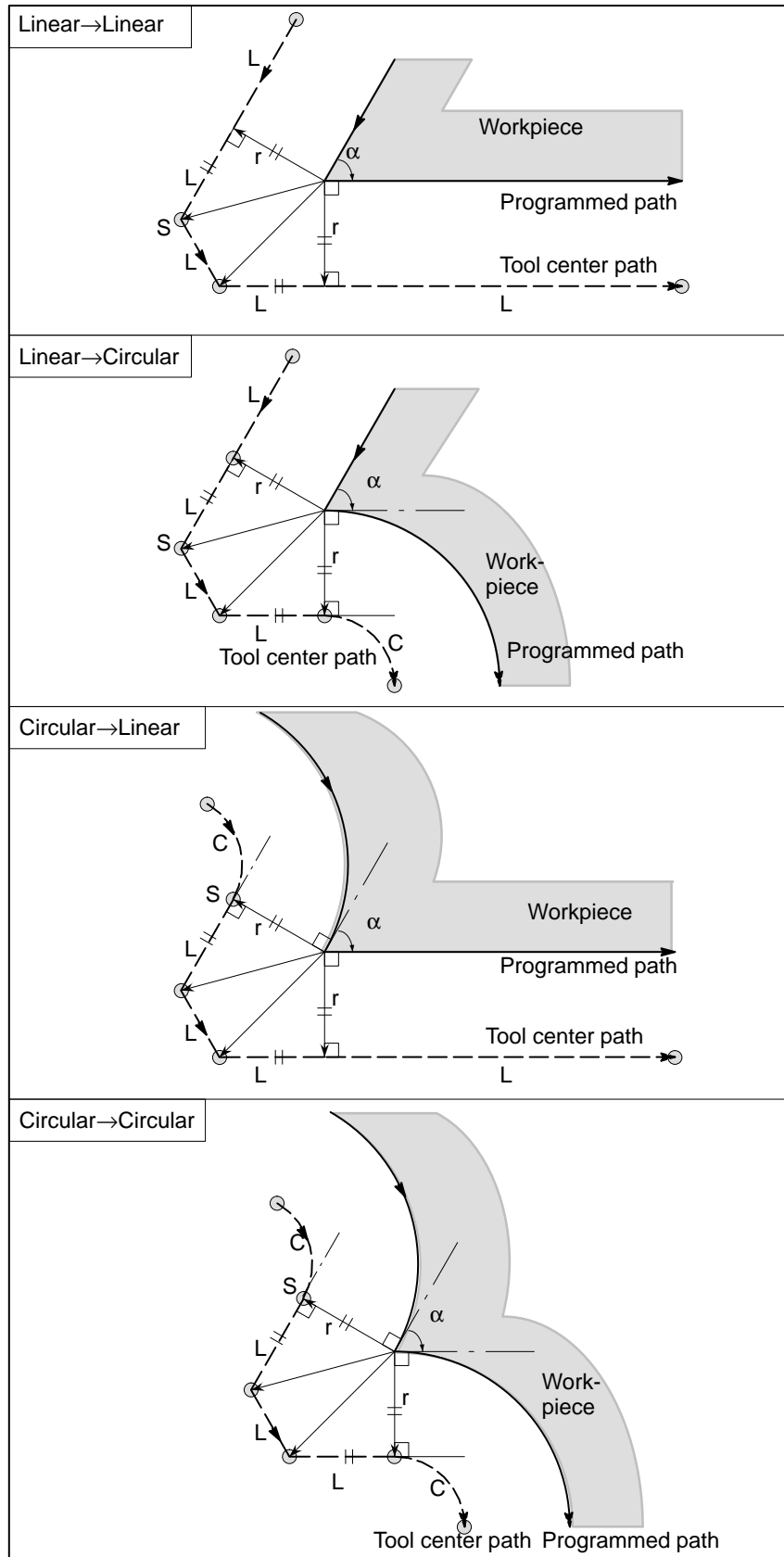


Also in case of arc to straight line, straight line to arc and arc to arc, the reader should infer in the same procedure.

- Tool movement around the outside corner at an obtuse angle ($90^\circ \leq \alpha < 180^\circ$)



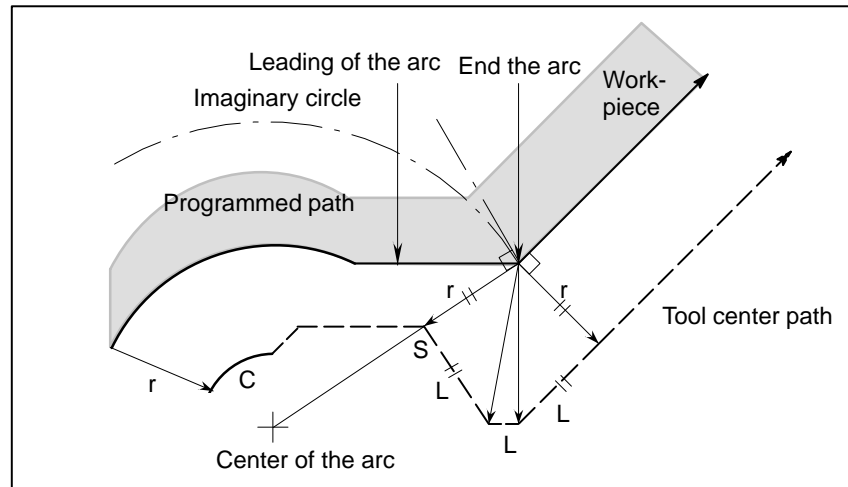
- Tool movement around the outside corner at an acute angle ($\alpha < 90^\circ$)



• When it is exceptional

End position for the arc is not on the arc

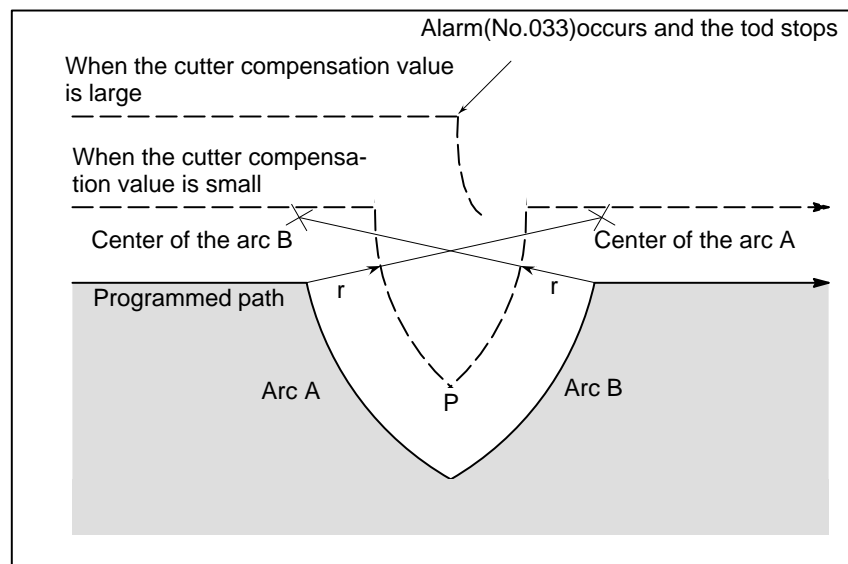
If the end of a line leading to an arc is programmed as the end of the arc by mistake as illustrated below, the system assumes that cutter compensation has been executed with respect to an imaginary circle that has the same center as the arc and passes the specified end position. Based on this assumption, the system creates a vector and carries out compensation. The resulting tool center path is different from that created by applying cutter compensation to the programmed path in which the line leading to the arc is considered straight.



The same description applies to tool movement between two circular paths.

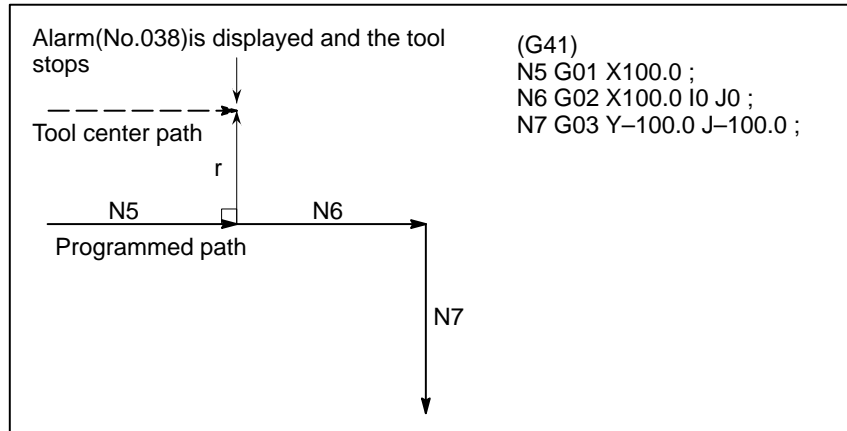
There is no inner intersection

If the cutter compensation value is sufficiently small, the two circular tool center paths made after compensation intersect at a position (P). Intersection P may not occur if an excessively large value is specified for cutter compensation. When this is predicted, P/S alarm No.033 occurs at the end of the previous block and the tool is stopped. In the example shown below, tool center paths along arcs A and B intersect at P when a sufficiently small value is specified for cutter compensation. If an excessively large value is specified, this intersection does not occur.



The center of the arc is identical with the start position or the end position

If the center of the arc is identical with the start position or end point, P/S alarm (No. 038) is displayed, and the tool will stop at the end position of the preceding block.



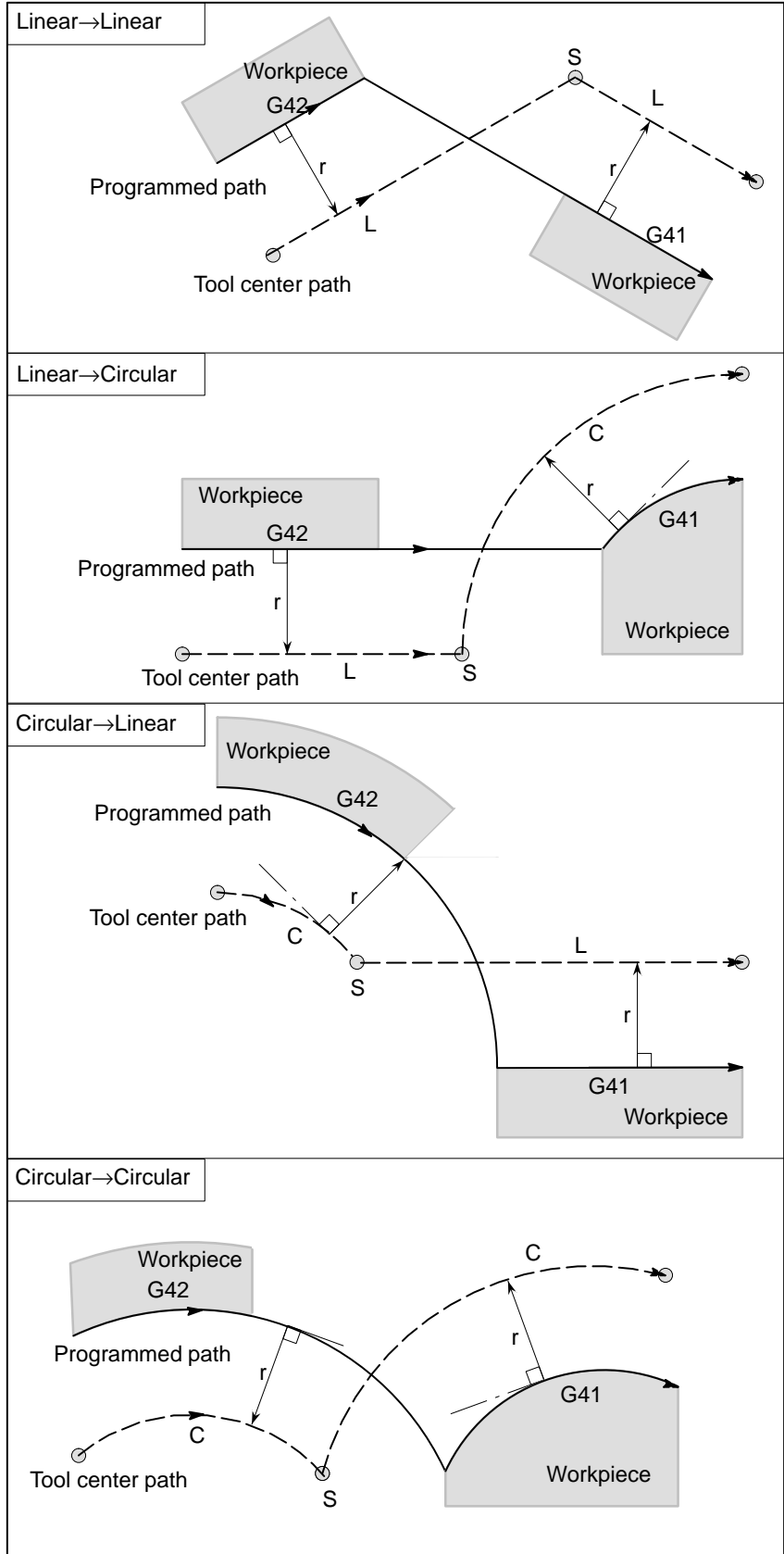
• **Change in the offset direction in the offset mode**

The offset direction is decided by G codes (G41 and G42) for cutter radius and the sign of cutter compensation value as follows.

Gcode	Sign of offset amount	
	+	-
G41	Left side offset	Right side offset
G42	Right side offset	Left side offset

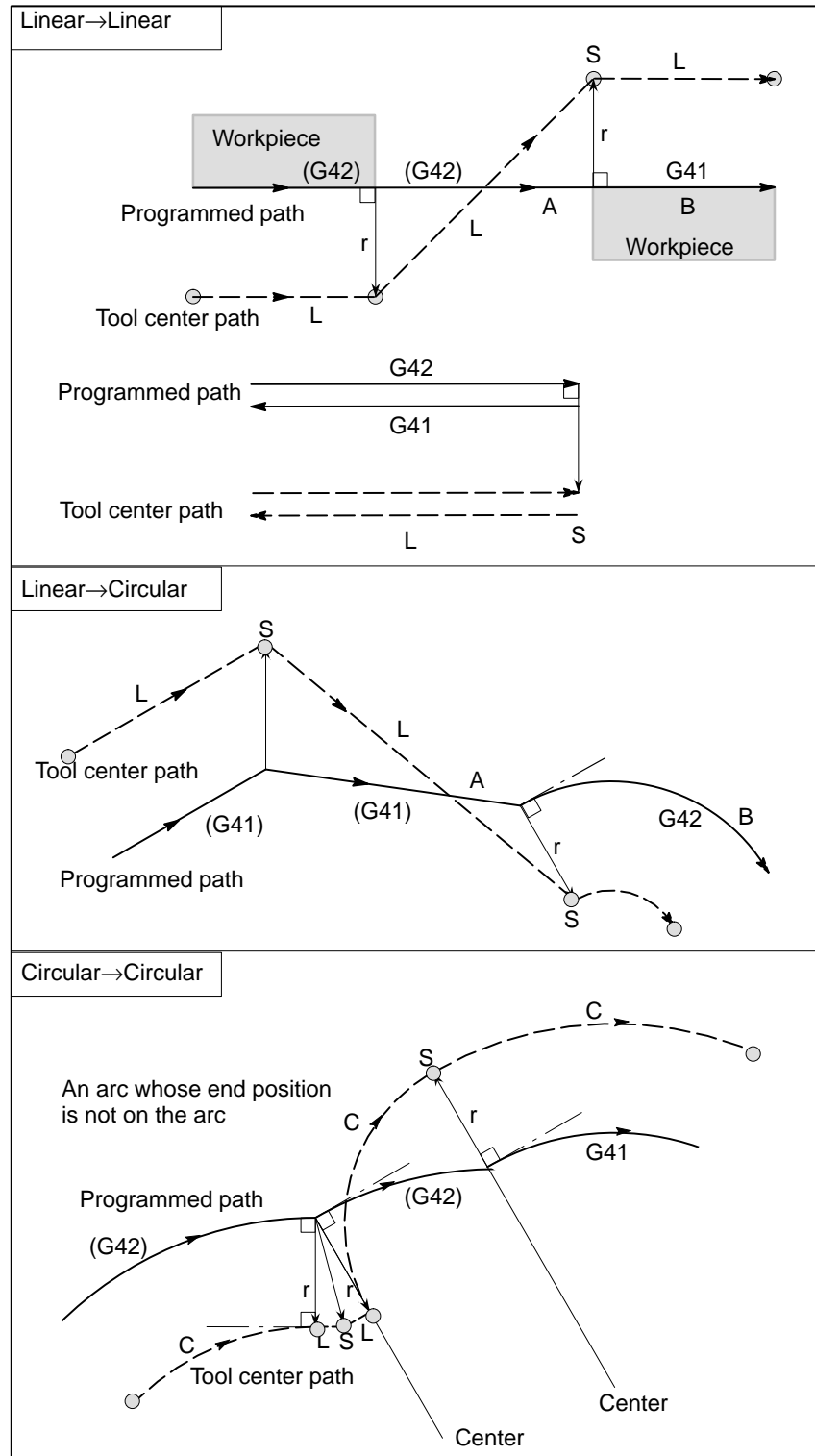
The offset direction can be changed in the offset mode. If the offset direction is changed in a block, a vector is generated at the intersection of the tool center path of that block and the tool center path of a preceding block. However, the change is not available in the start-up block and the block following it.

Tool center path with an inter-section



Tool center path without an intersection

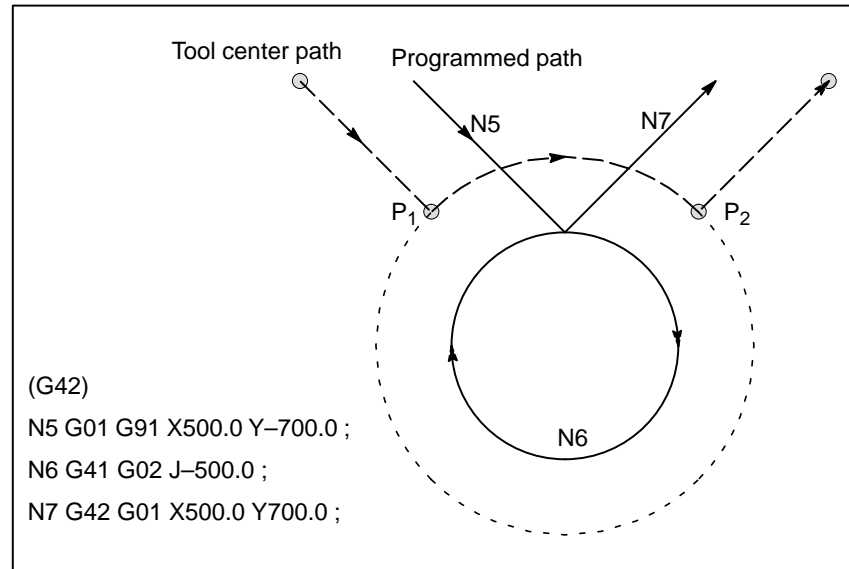
When changing the offset direction in block A to block B using G41 and G42, if intersection with the offset path is not required, the vector normal to block B is created at the start point of block B.



**The length of tool center path
larger than the circumference
of a circle**

Normally there is almost no possibility of generating this situation. However, when G41 and G42 are changed, or when a G40 was commanded with address I, J, and K this situation can occur.

In this case of the figure, the cutter compensation is not performed with more than one circle circumference: an arc is formed from P₁ to P₂ as shown. Depending on the circumstances, an alarm may be displayed due to the "Interference Check" described later. To execute a circle with more than one circumference, the circle must be specified in segments.

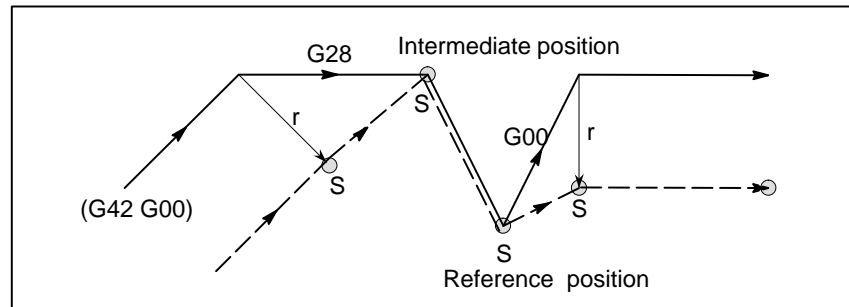


• **Temporary cutter compensation cancel**

If the following command is specified in the offset mode, the offset mode is temporarily canceled then automatically restored. The offset mode can be canceled and started as described in II-15.6.2 and 15.6.4.

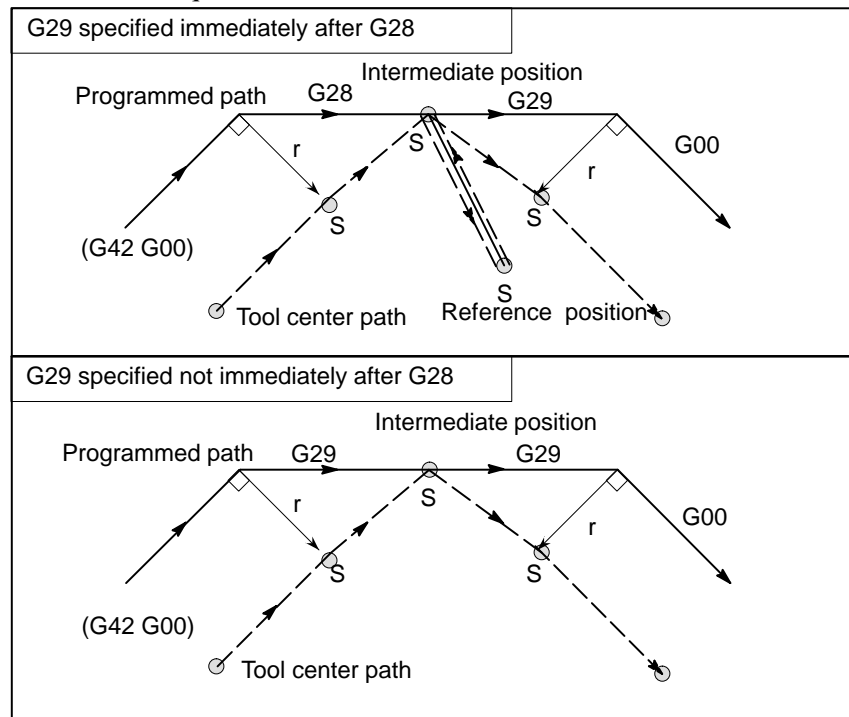
Specifying G28 (automatic return to the reference position) in the offset mode

If G28 is specified in the offset mode, the offset mode is canceled at an intermediate position. If the vector still remains after the tool is returned to the reference position, the components of the vector are reset to zero with respect to each axis along which reference position return has been made.



Specifying G29 (automatic return from the reference position) in the offset mode

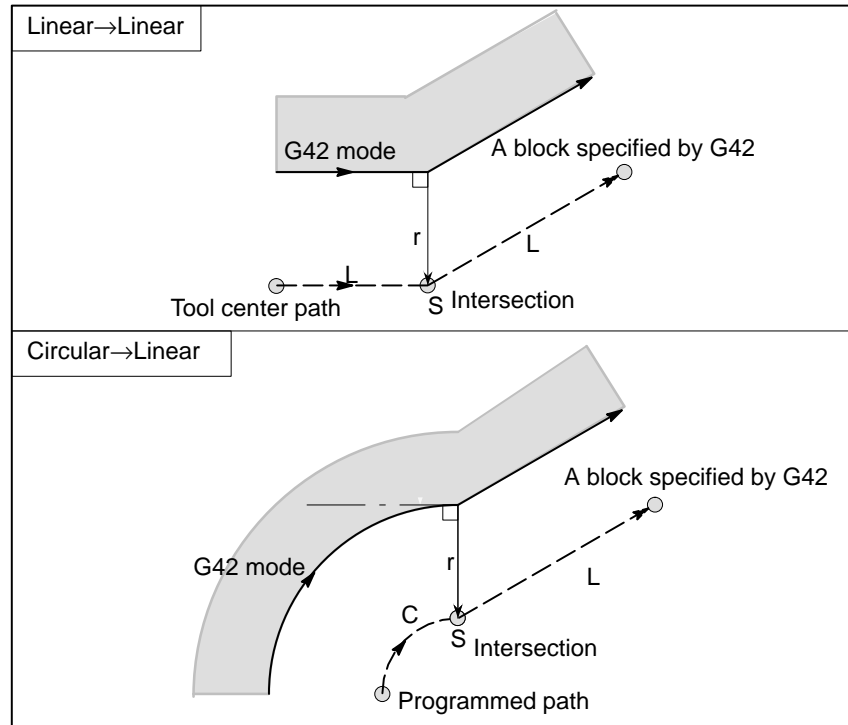
If G29 is commanded in the offset mode, the offset will be cancelled at the intermediate point, and the offset mode will be restored automatically from the subsequent block.



● **Cutter compensation G code in the offset mode**

The offset vector can be set to form a right angle to the moving direction in the previous block, irrespective of machining inner or outer side, by commanding the cutter compensation G code (G41, G42) in the offset mode, independently. If this code is specified in a circular command, correct circular motion will not be obtained.

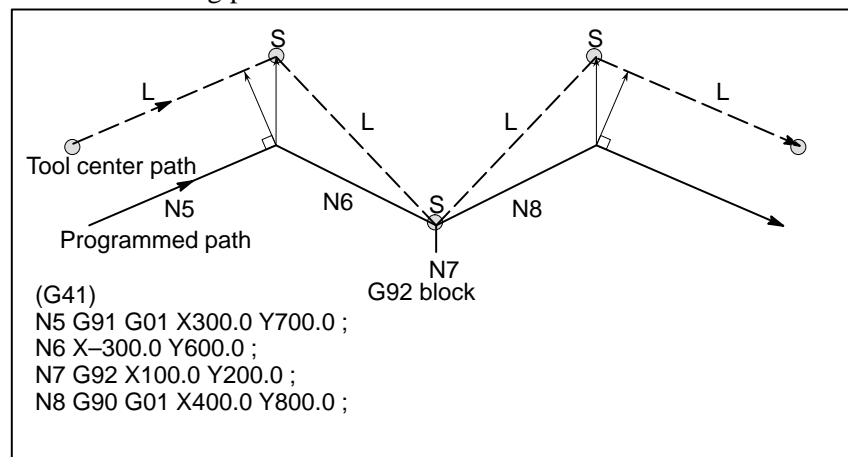
When the direction of offset is expected to be changed by the command of cutter compensation G code (G41, G42), refer to Subsec.15.6.3.



● **Command cancelling the offset vector temporarily**

During offset mode, if G92 (absolute zero point programming) is commanded, the offset vector is temporarily cancelled and thereafter offset mode is automatically restored.

In this case, without movement of offset cancel, the tool moves directly from the intersecting point to the commanded point where offset vector is canceled. Also when restored to offset mode, the tool moves directly to the intersecting point.



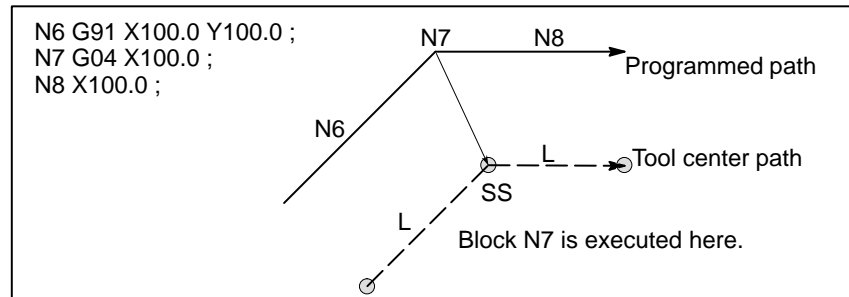
- **A block without tool movement**

The following blocks have no tool movement. In these blocks, the tool will not move even if cutter compensation is effected.

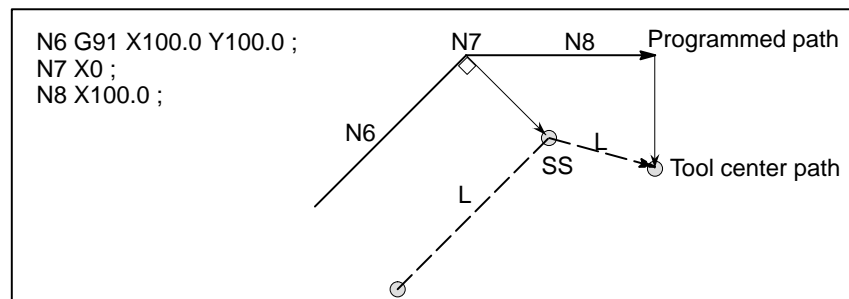
M05 ; . M code output	} Commands (1) to (6) are of no movement.
S21 ; . S code output	
G04 X10.0 ; Dwell	
G10 L11 P01 R10.0 ; Cutter compensation value setting (G17) Z200.0 ; Move command not included in the offset plane.	
G90 ; . G code only	
G91 X0 ; Move distance is zero.	

- **A block without tool movement specified in offset mode**

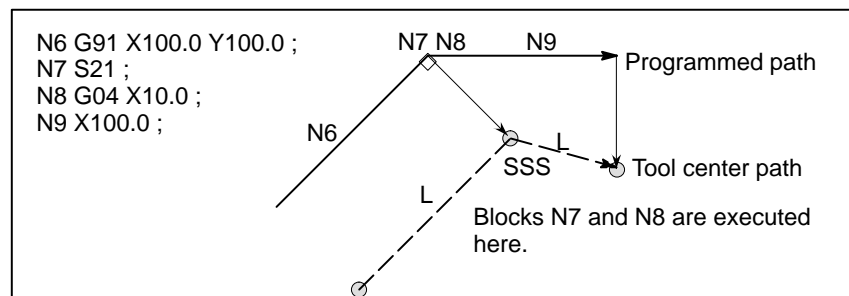
When a single block without tool movement is commanded in the offset mode, the vector and tool center path are the same as those when the block is not commanded. This block is executed at the single block stop point.



However, when the move distance is zero, even if the block is commanded singly, tool motion becomes the same as that when more than one block of without tool movement are commanded, which will be described subsequently.



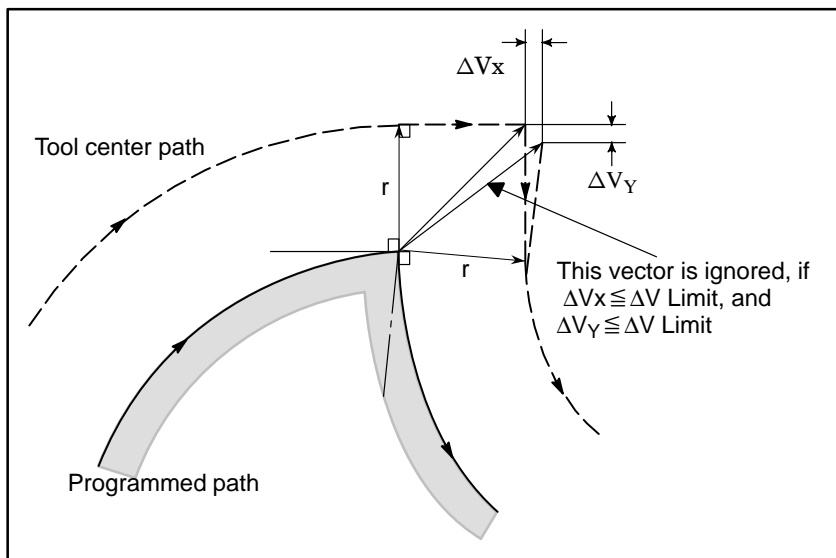
Two blocks without tool movement should not be commanded consecutively. If commanded, a vector whose length is equal to the offset value is produced in a normal direction to tool motion in earlier block, so overcutting may result.



• **Corner movement**

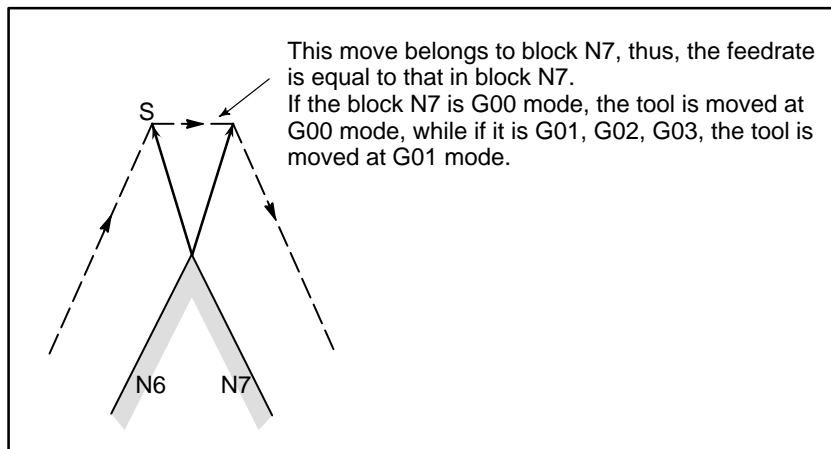
When two or more vectors are produced at the end of a block, the tool moves linearly from one vector to another. This movement is called the corner movement.

If these vectors almost coincide with each other, the corner movement isn't performed and the latter vector is ignored.



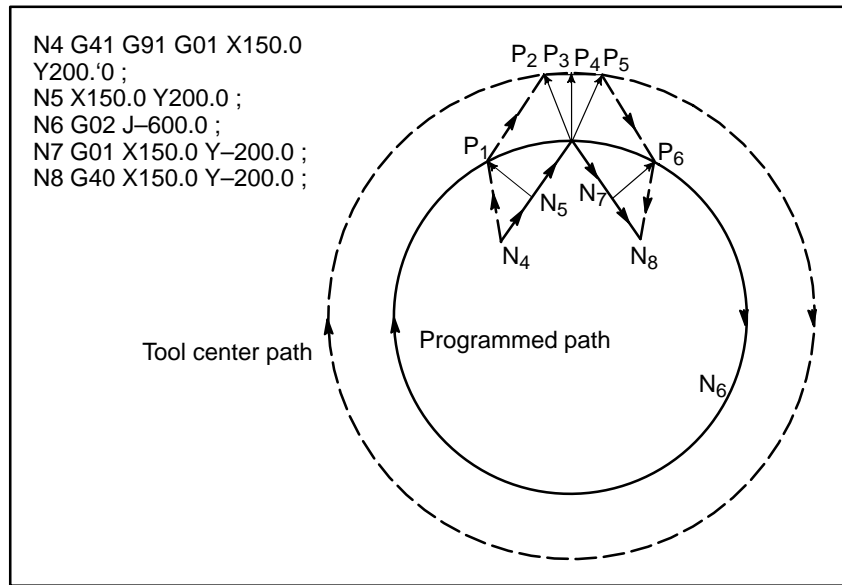
If $\Delta V_x \leq \Delta V_{limit}$ and $\Delta V_y \leq \Delta V_{limit}$, the latter vector is ignored. The ΔV_{limit} is set in advance by parameter (No. 5010).

If these vectors do not coincide, a move is generated to turn around the corner. This move belongs to the latter block.



However, if the path of the next block is semicircular or more, the above function is not performed.

The reason for this is as follows:



If the vector is not ignored, the tool path is as follows:

$P_1 \rightarrow P_2 \rightarrow P_3 \rightarrow (\text{Circle}) \rightarrow P_4 \rightarrow P_5 \rightarrow P_6$

But if the distance between P2 and P3 is negligible, the point P3 is ignored. Therefore, the tool path is as follows:

$P_2 \rightarrow P_4$

Namely, circle cutting by the block N6 is ignored.

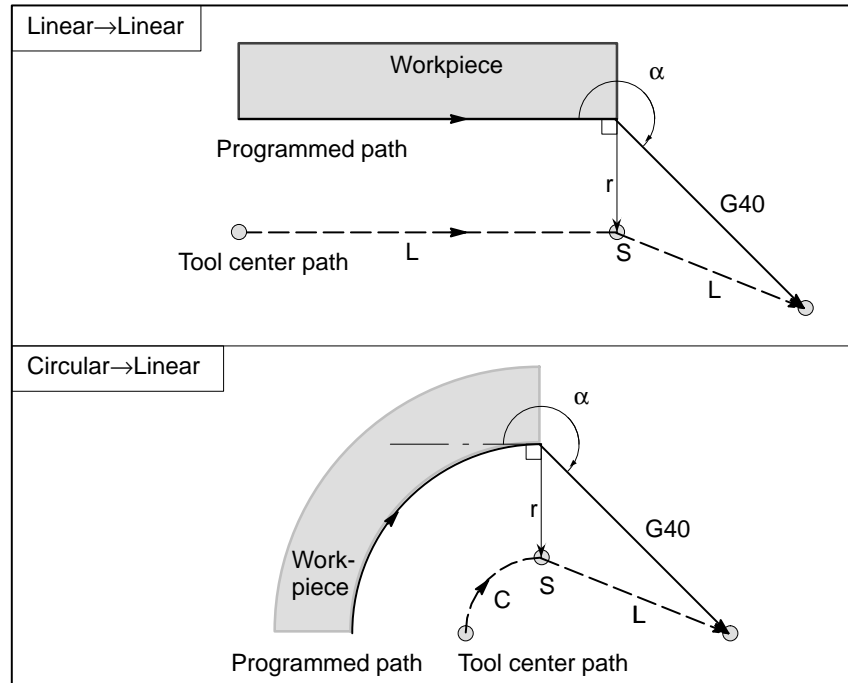
- **Interruption of manual operation**

For manual operation during the cutter compensation, refer to Section III-3.5, “Manual Absolute ON and OFF.”

14.6.4 Tool Movement in Offset Mode Cancel

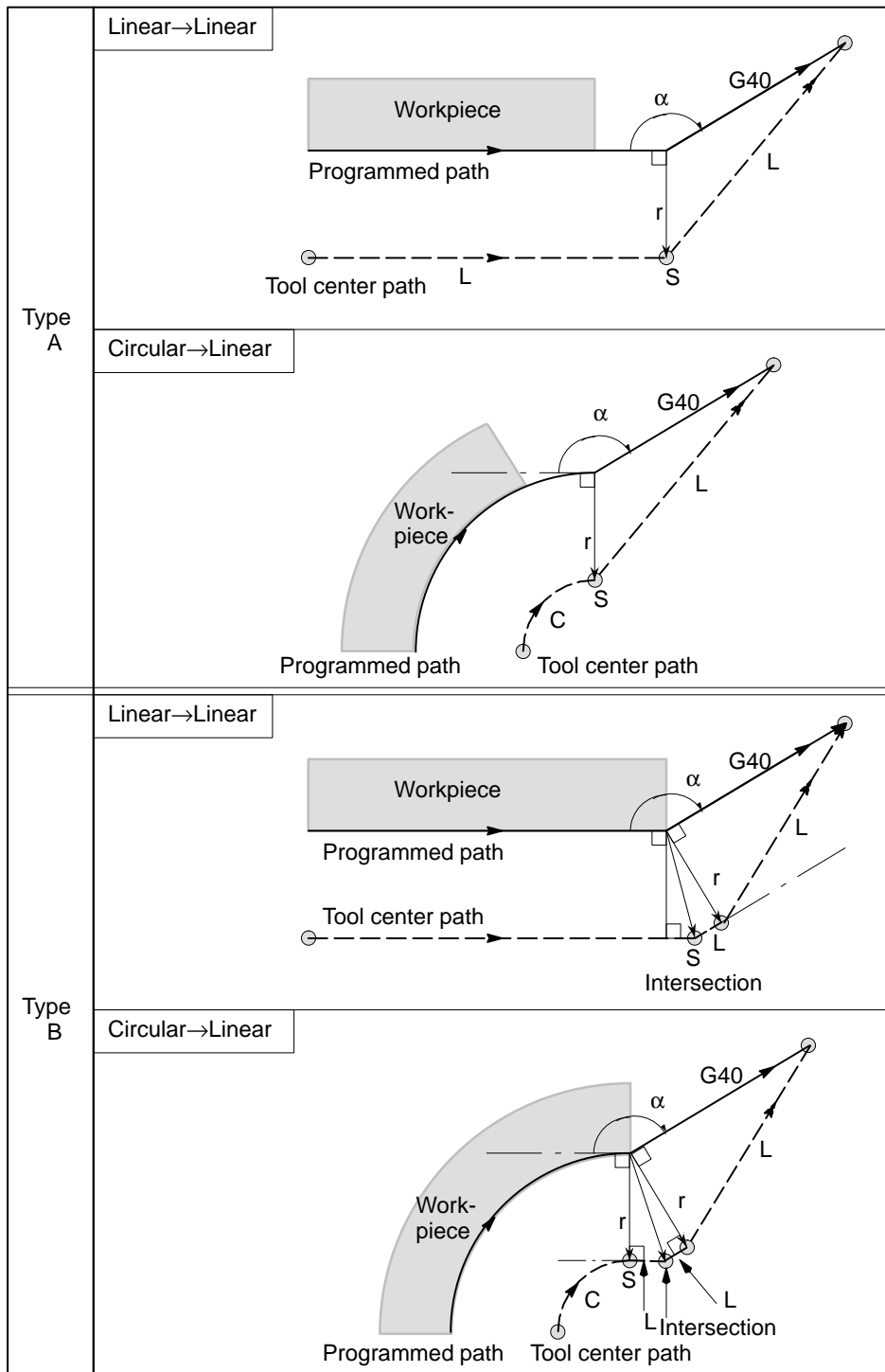
Explanations

- Tool movement around an inside corner ($180^\circ \leq \alpha$)



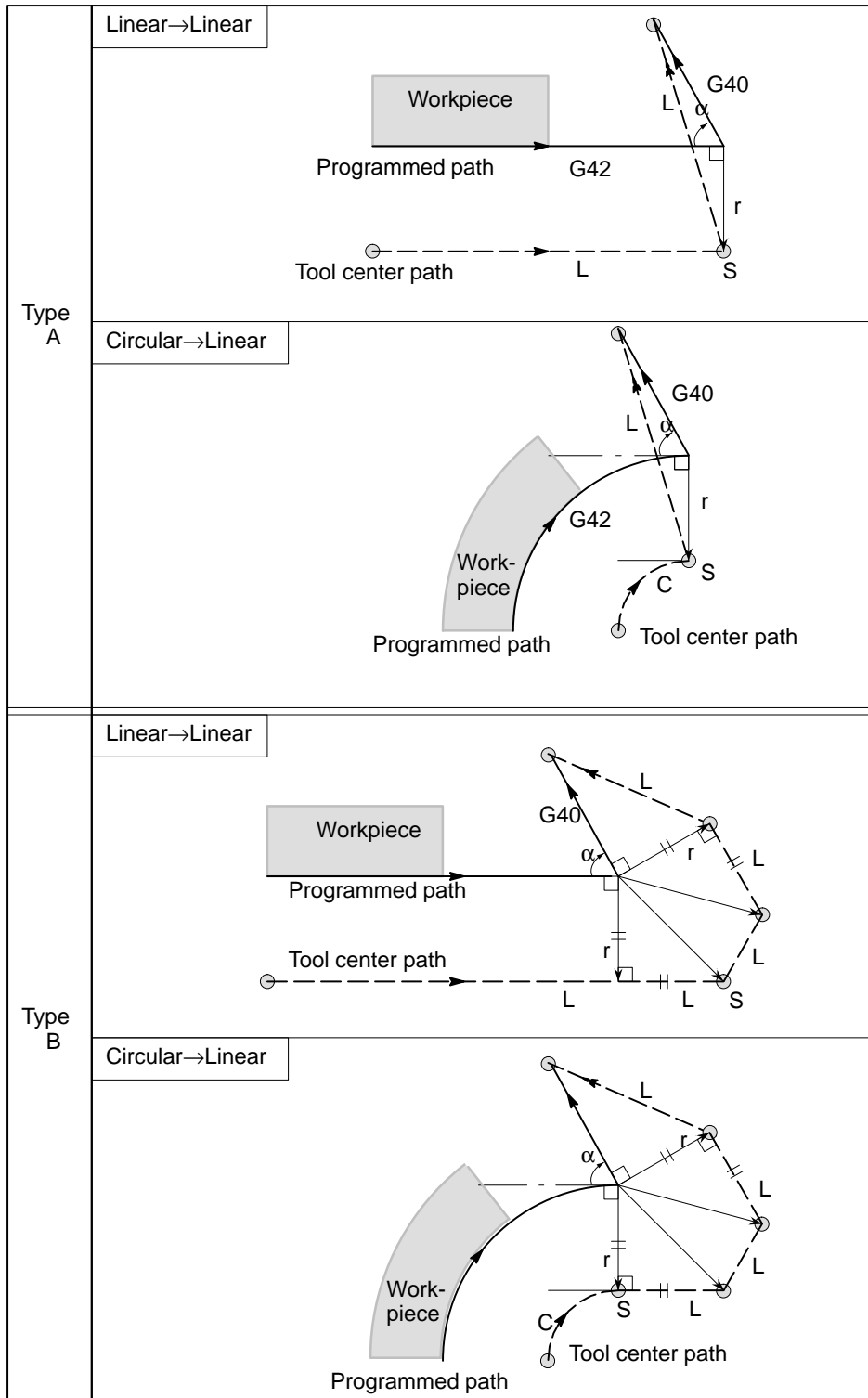
- **Tool movement around an outside corner at an obtuse angle ($90^\circ \leq \alpha < 180^\circ$)**

Tool path has two types, A and B; and they are selected by parameter SUP (No. 5003#0).

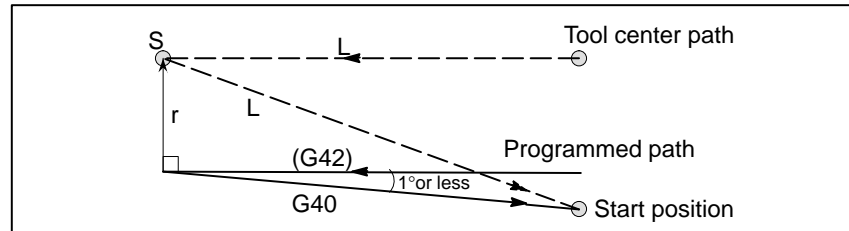


• **Tool movement around an outside corner at an acute angle ($\alpha < 90^\circ$)**

Tool path has two types, A and B : and they are selected by parameter SUP (No. 5003#0)

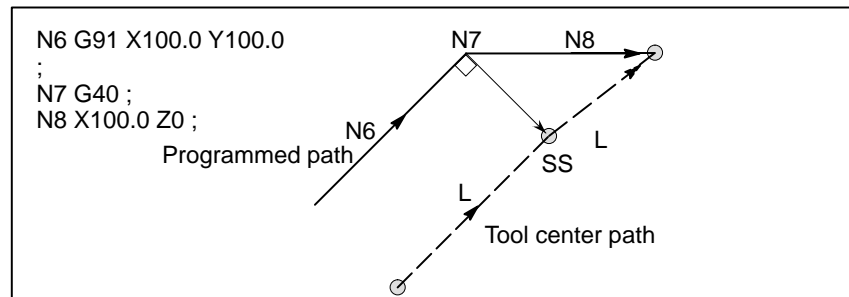


- Tool movement around the outside linear → linear at an acute angle less than 1 degree ($\alpha < 1^\circ$)



- A block without tool movement specified together with offset cancel

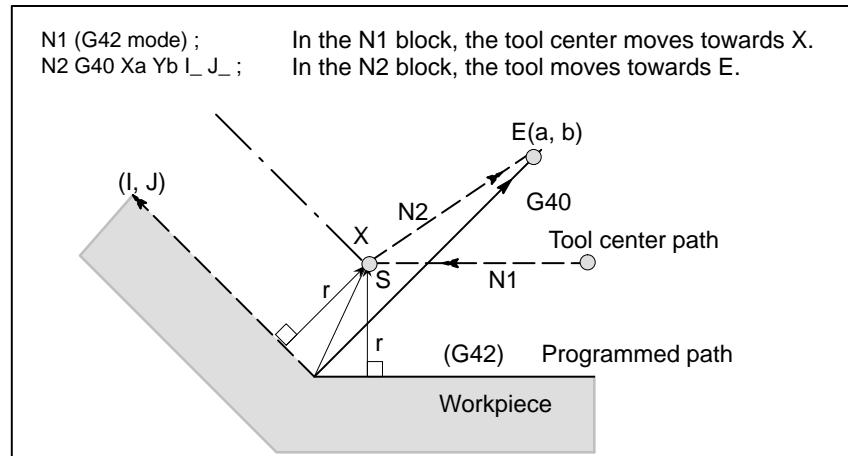
When a block without tool movement is commanded together with an offset cancel, a vector whose length is equal to the offset value is produced in a normal direction to tool motion in the earlier block, the vector is cancelled in the next move command.



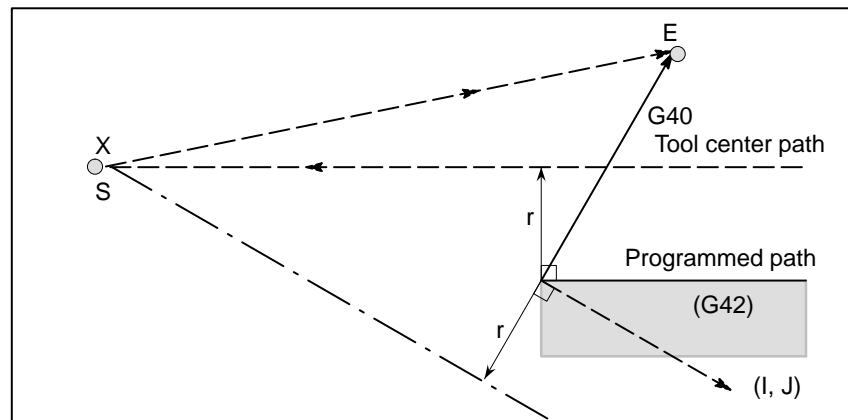
• **Block containing G40 and I_J_K_**

The previous block contains G41 or G42

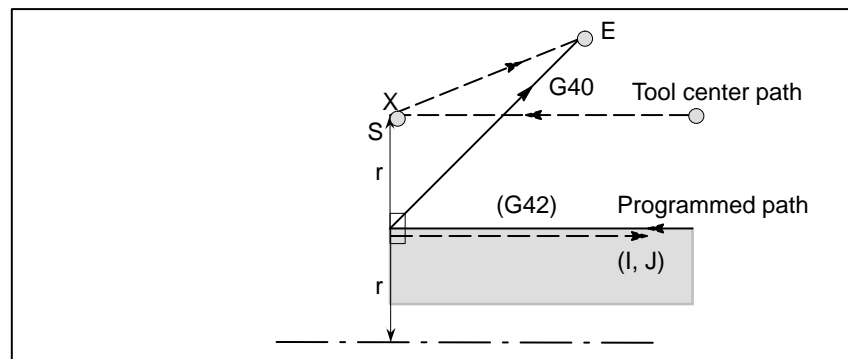
If a G41 or G42 block precedes a block in which G40 and I_, J_, K_ are specified, the system assumes that the path is programmed as a path from the end position determined by the former block to a vector determined by (I,J), (I,K), or (J,K). The direction of compensation in the former block is inherited.



In this case, note that the CNC obtains an intersection of the tool path irrespective of whether inner or outer side machining is specified

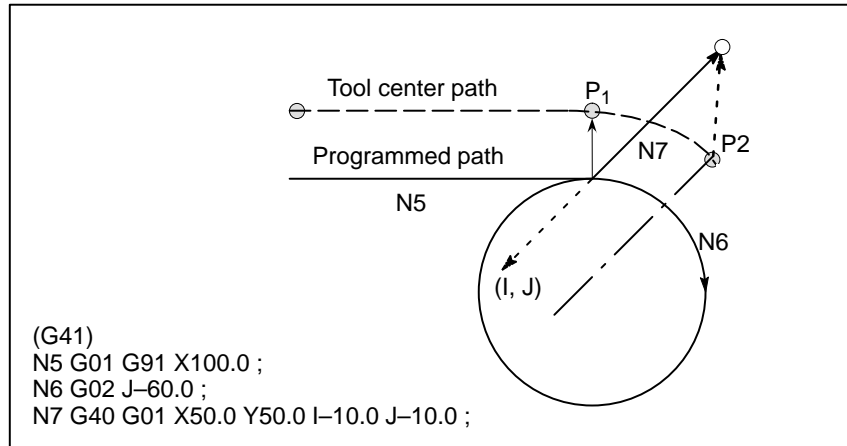


When an intersection is not obtainable, the tool comes to the normal position to the previous block at the end of the previous block.



The length of the tool center path larger than the circumference of a circle

In the example shown below, the tool does not trace the circle more than once. It moves along the arc from P1 to P2. The interference check function described in II-15.6.5 may raise an alarm.



To make the tool trace a circle more than once, program two or more arcs.

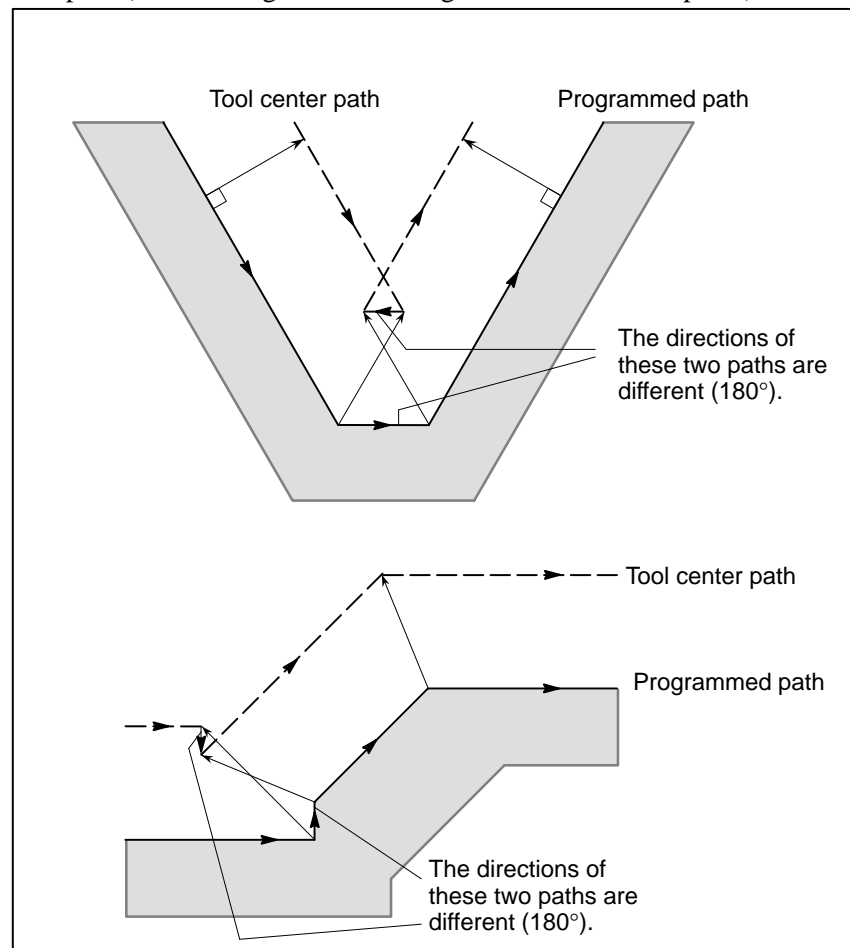
14.6.5 Interference Check

Tool overcutting is called interference. The interference check function checks for tool overcutting in advance. However, all interference cannot be checked by this function. The interference check is performed even if overcutting does not occur.

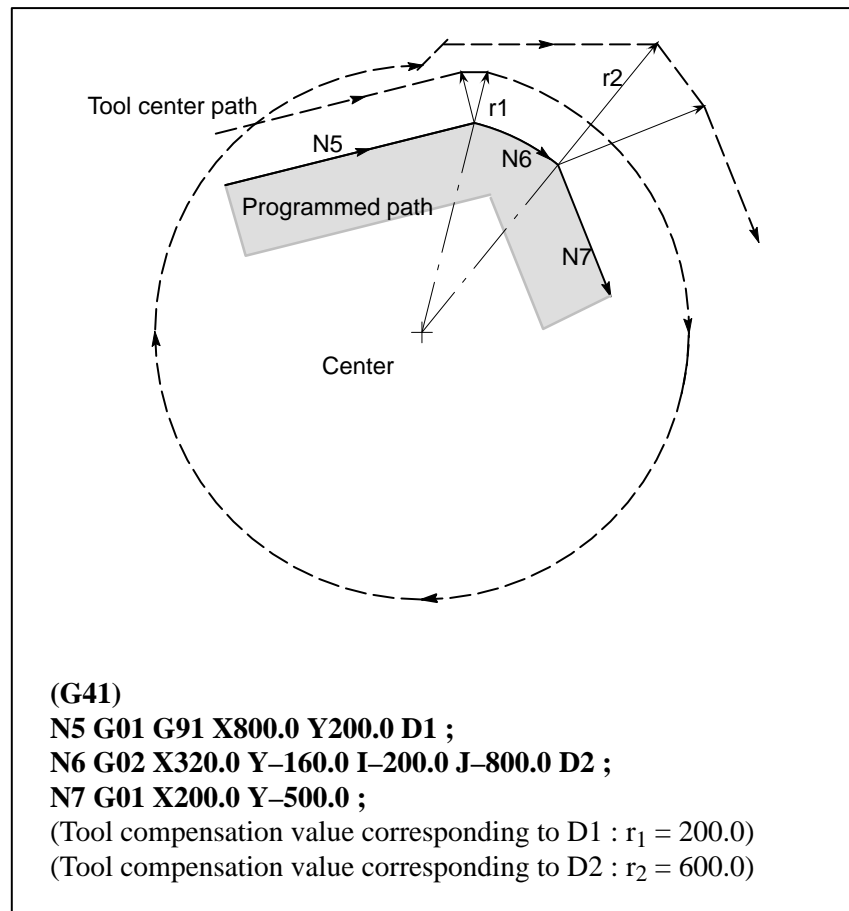
Explanations

- **Criteria for detecting interference**

- (1) The direction of the tool path is different from that of the programmed path (from 90 degrees to 270 degrees between these paths).



- (2) In addition to the condition (1), the angle between the start point and end point on the tool center path is quite different from that between the start point and end point on the programmed path in circular machining (more than 180 degrees).



In the above example, the arc in block N6 is placed in the one quadrant. But after cutter compensation, the arc is placed in the four quadrants.

- **Correction of interference in advance**

(1) Removal of the vector causing the interference

When cutter compensation is performed for blocks A, B and C and vectors V_1, V_2, V_3 and V_4 between blocks A and B, and V_5, V_6, V_7 and V_8 between B and C are produced, the nearest vectors are checked first. If interference occurs, they are ignored. But if the vectors to be ignored due to interference are the last vectors at the corner, they cannot be ignored.

Check between vectors V_4 and V_5

Interference — V_4 and V_5 are ignored.

Check between V_3 and V_6

Interference — V_3 and V_6 are ignored

Check between V_2 and V_7

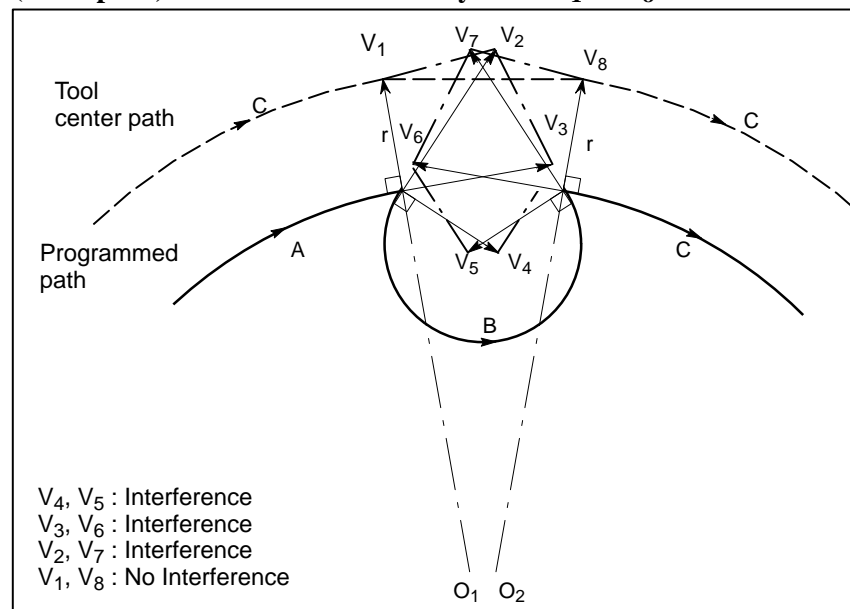
Interference — V_2 and V_7 are Ignored

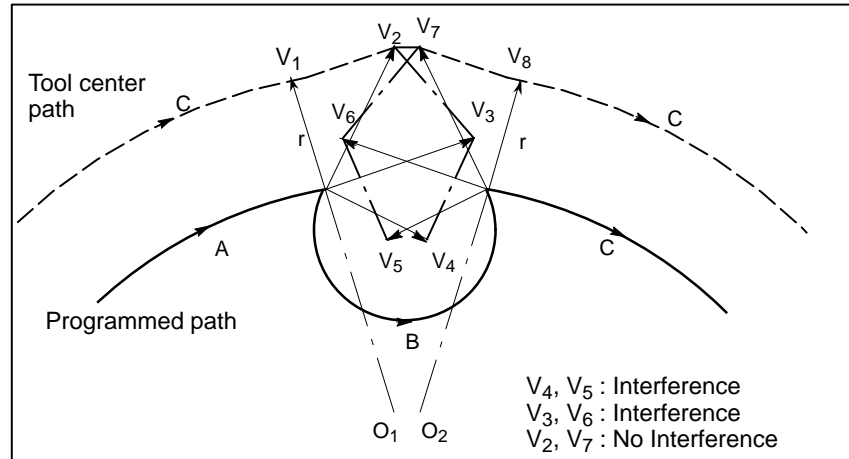
Check between V_1 and V_8

Interference — V_1 and V_8 are cannot be ignored

If while checking, a vector without interference is detected, subsequent vectors are not checked. If block B is a circular movement, a linear movement is produced if the vectors are interfered.

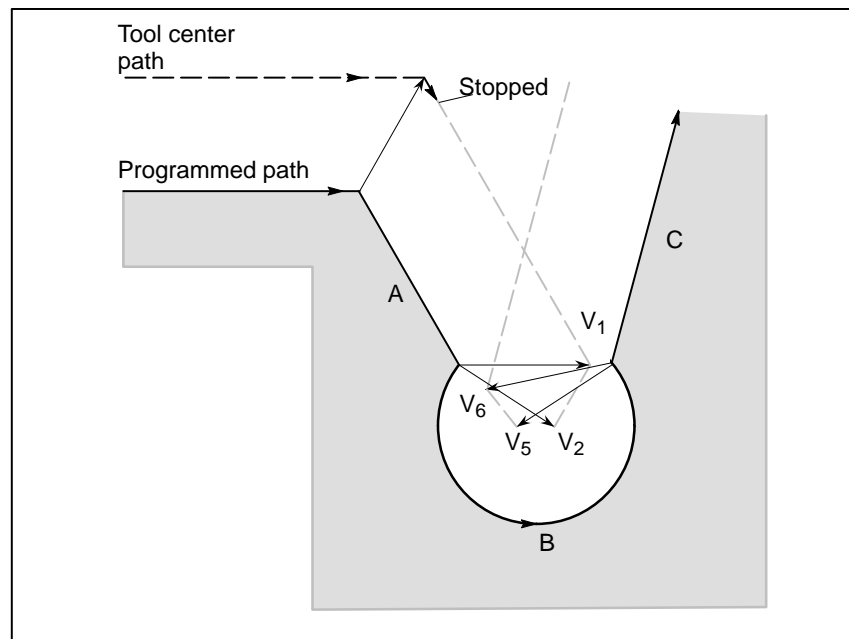
(Example 1) The tool moves linearly from V_1 to V_8



(Example 2) The tool moves linearly from V_1 , V_2 , V_7 , to V_8 

(2) If the interference occurs after correction (1), the tool is stopped with an alarm.

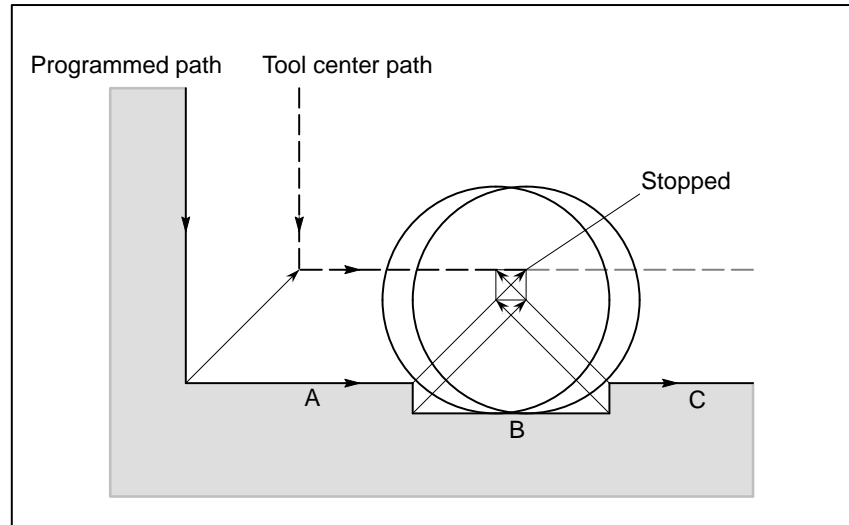
If the interference occurs after correction (1) or if there are only one pair of vectors from the beginning of checking and the vectors interfere, the P/S alarm (No.41) is displayed and the tool is stopped immediately after execution of the preceding block. If the block is executed by the single block operation, the tool is stopped at the end of the block.



After ignoring vectors V_2 and V_5 because of interference, interference also occurs between vectors V_1 and V_6 . The alarm is displayed and the tool is stopped.

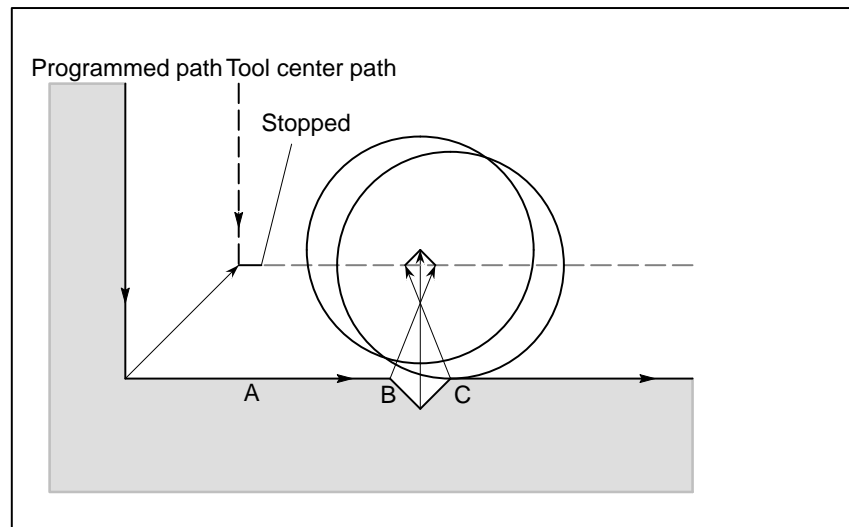
- When interference is assumed although actual interference does not occur

(1) Depression which is smaller than the cutter compensation value



There is no actual interference, but since the direction programmed in block B is opposite to that of the path after cutter compensation the tool stops and an alarm is displayed.

(2) Groove which is smaller than the cutter compensation value



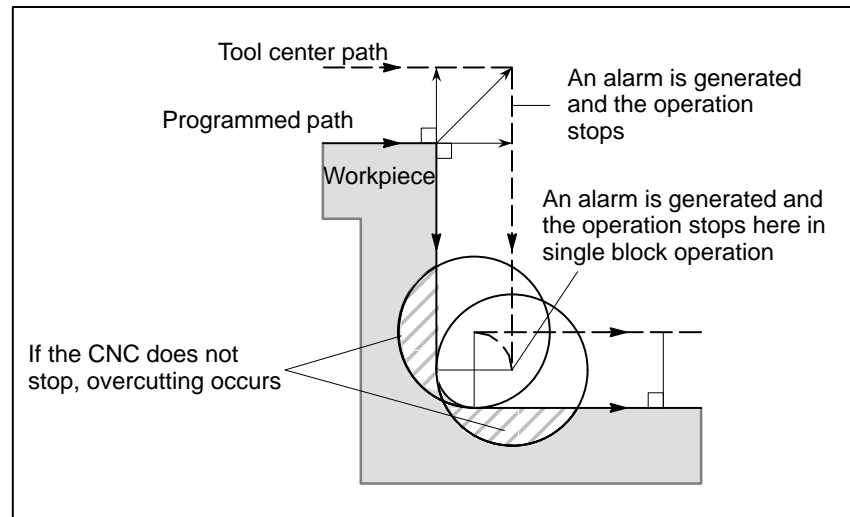
Like (1), P/S alarm is displayed because of the interference as the direction is reverse in block B.

14.6.6 Overcutting by Cutter Compensation

Explanations

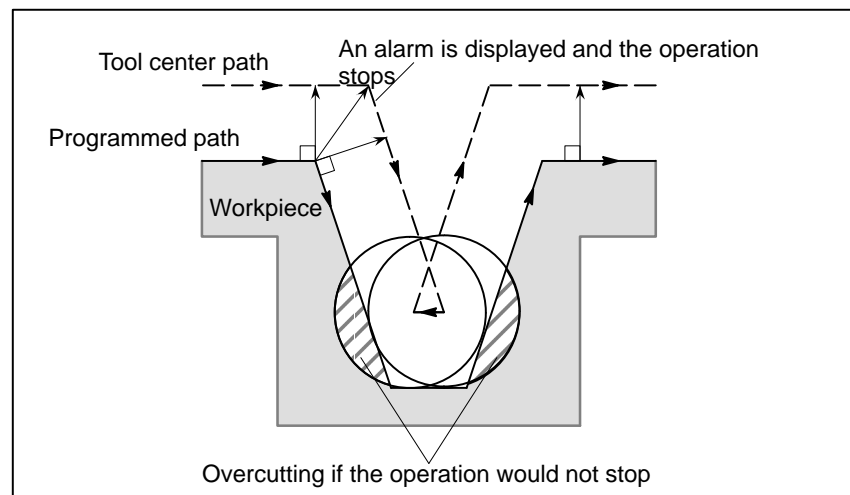
- **Machining an inside corner at a radius smaller than the cutter radius**

When the radius of a corner is smaller than the cutter radius, because the inner offsetting of the cutter will result in overcuttings, an alarm is displayed and the CNC stops at the start of the block. In single block operation, the overcutting is generated because the tool is stopped after the block execution.



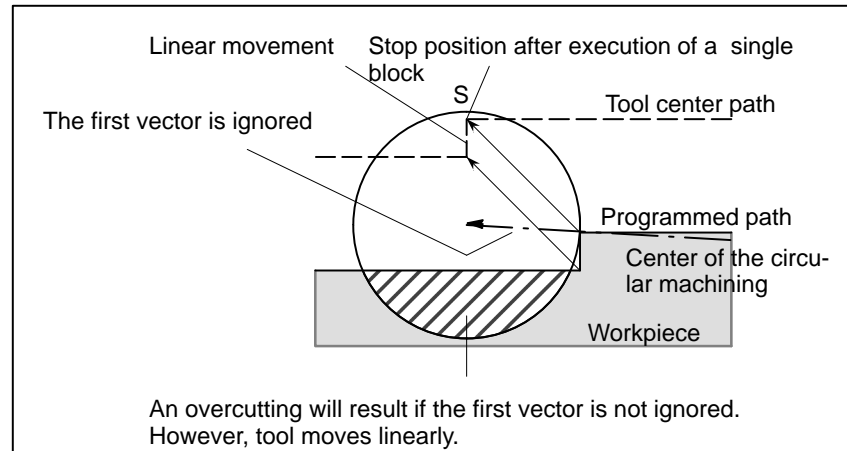
- **Machining a groove smaller than the tool radius**

Since the cutter compensation forces the path of the center of the tool to move in the reverse of the programmed direction, overcutting will result. In this case an alarm is displayed and the CNC stops at the start of the block.



- **Machining a step smaller than the tool radius**

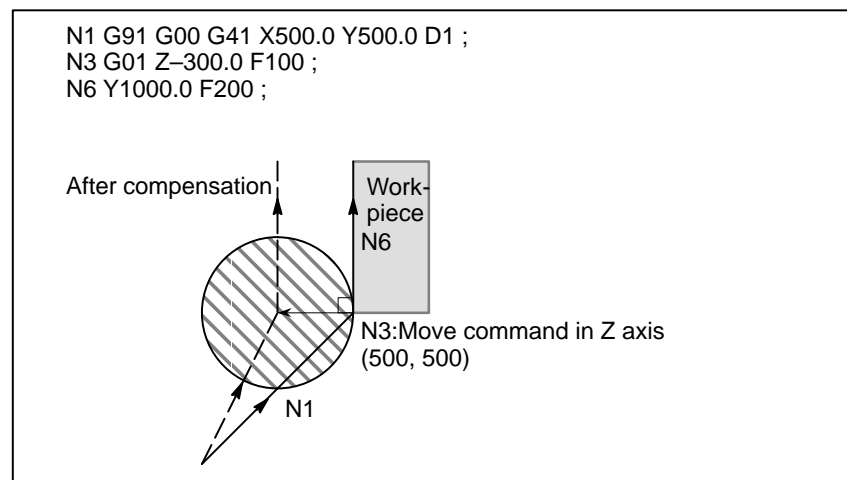
When machining of the step is commanded by circular machining in the case of a program containing a step smaller than the tool radius, the path of the center of tool with the ordinary offset becomes reverse to the programmed direction. In this case, the first vector is ignored, and the tool moves linearly to the second vector position. The single block operation is stopped at this point. If the machining is not in the single block mode, the cycle operation is continued. If the step is of linear, no alarm will be generated and cut correctly. However uncut part will remain.



- **Starting compensation and cutting along the Z-axis**

It is usually used such a method that the tool is moved along the Z axis after the cutter compensation is effected at some distance from the workpiece at the start of the machining.

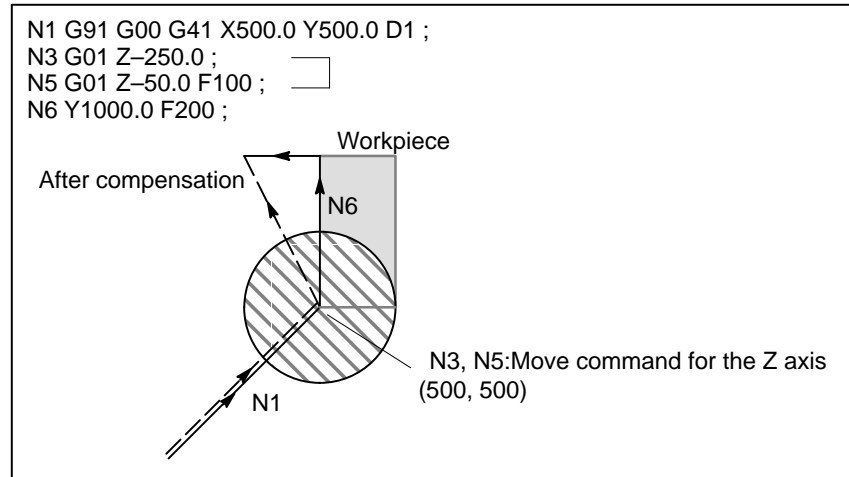
In the case above, if it is desired to divide the motion along the Z axis into rapid traverse and cutting feed, follow the procedure below.



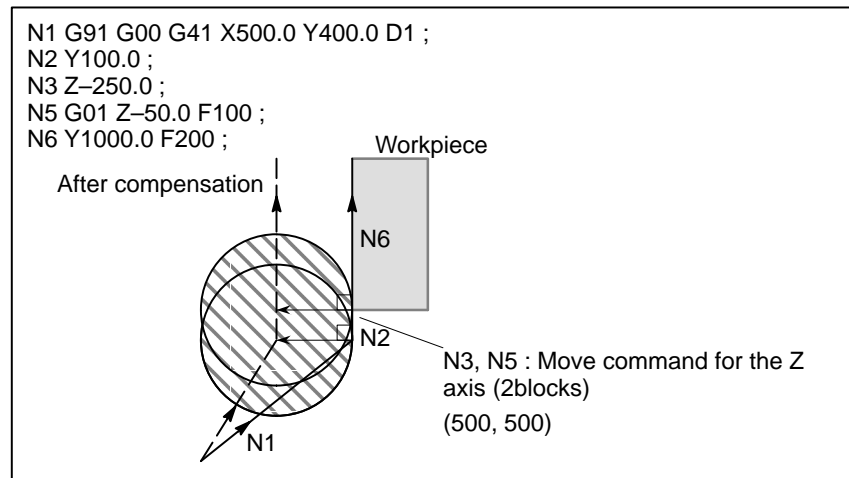
In the program example above, when executing block N1, blocks N3 and N6 are also entered into the buffer storage, and by the relationship among them the correct compensation is performed as in the figure above.

Then, if the block N3 (move command in Z axis) is divided as follows: As there are two move command blocks not included in the selected plane and the block N6 cannot be entered into the buffer storage, the tool center path is calculated by the information of N1 in the figure above. That is, the offset vector is not calculated in start-up and the overcutting may result.

The above example should be modified as follows:



The move command in the same direction as that of the move command after the motion in Z axis should be programmed.



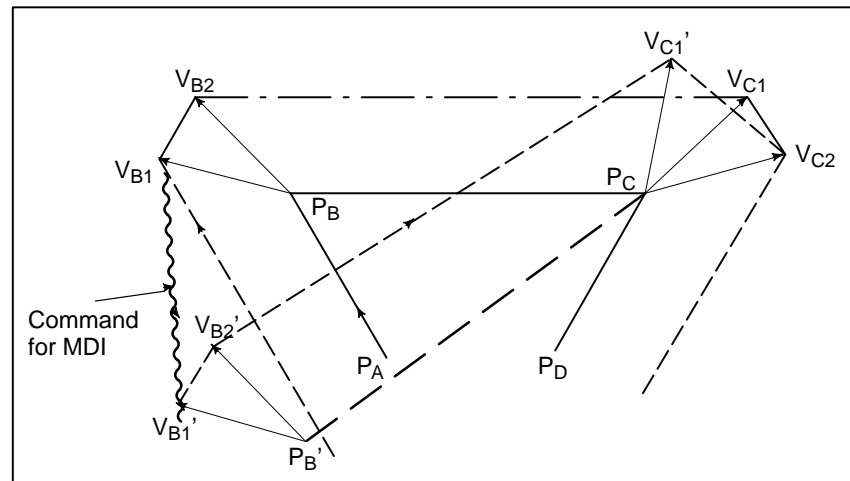
As the block with sequence No. N2 has the move command in the same direction as that of the block with sequence No. N6, the correct compensation is performed.

14.6.7 Input Command from MDI

Cutter compensation C is not performed for commands input from the MDI.

However, when automatic operation using the absolute commands is temporarily stopped by the single block function, MDI operation is performed, then automatic operation starts again, the tool path is as follows :

In this case, the vectors at the start position of the next block are translated and the other vectors are produced by the next two blocks. Therefore, from next block but one, cutter compensation C is accurately performed.



When position P_A , P_B , and P_C are programmed in an absolute command, tool is stopped by the single block function after executing the block from P_A to P_B and the tool is moved by MDI operation. Vectors V_{B1} and V_{B2} are translated to V_{B1}' and V_{B2}' and offset vectors are recalculated for the vectors V_{C1} and V_{C2} between block P_B - P_C and P_C - P_D .

However, since vector V_{B2} is not calculated again, compensation is accurately performed from position P_C .

14.6.8 G53,G28,G30,G30.1 and G29 Commands in Cutter Compensation C Mode

A function has been added which performs positioning by automatically canceling a cutter compensation vector when G53 is specified in cutter compensation C mode, then automatically restoring that cutter compensation vector with the execution of the next move command.

The cutter compensation vector restoration mode is of FS16 type when CCN (bit 2 of parameter No. 5003) is set to 0; it is of FS15 type when CCN is set to 1.

When G28, G30, or G30.1 is specified in cutter compensation C mode, automatic reference position return is performed by automatically canceling a cutter compensation vector, that cutter compensation vector automatically being restored with the execution of the next move command. In this case, the timing and format of cutter compensation vector cancellation/restoration, performed when CCN (bit 2 of parameter No. 5003) is set to 1, are changed to FS15 type.

When CCN (bit 2 of parameter No. 5003) is set to 0, the conventional specification remains applicable.

When G29 is specified in cutter compensation C mode, the cutter compensation vector is automatically canceled/restored. In this case, the timing and format of cutter compensation vector cancellation/restoration, performed when CCN (bit 2 of parameter No. 5003) is set to 1, are changed to FS15 type.

When CCN (bit 2 of parameter No. 5003) is set to 0, the conventional specification remains applicable.

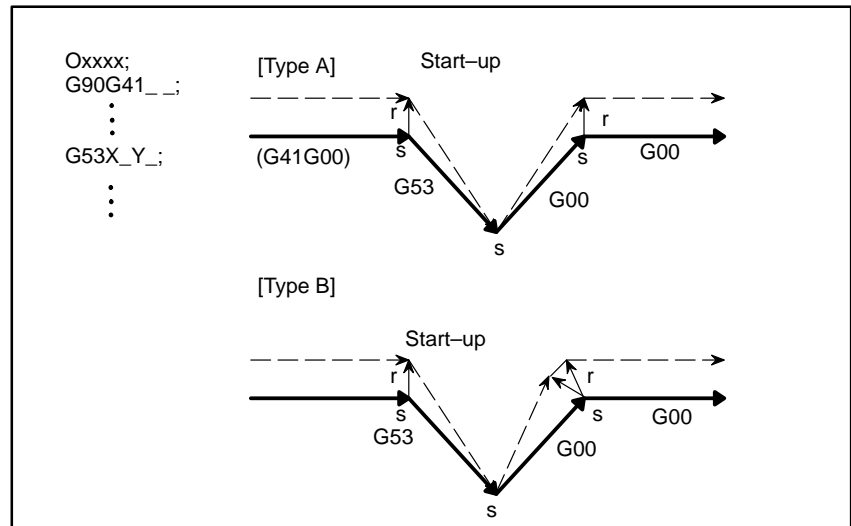
Explanations

- **G53 command in cutter compensation C mode**

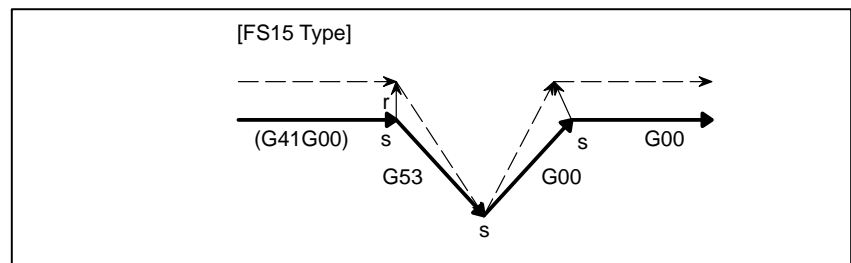
When G53 is specified in cutter compensation C mode, the previous block generates a vector that is perpendicular to the move direction and which has the same magnitude as the offset value. Then, the offset vector is canceled when movement to a specified position is performed in the machine coordinate system. In the next block, offset mode is automatically resumed.

Note that cutter compensation vector restoration is started when CCN (bit 2 of parameter No. 5003) is set to 0; when CCN is set to 1, an intersection vector is generated (FS15 type).

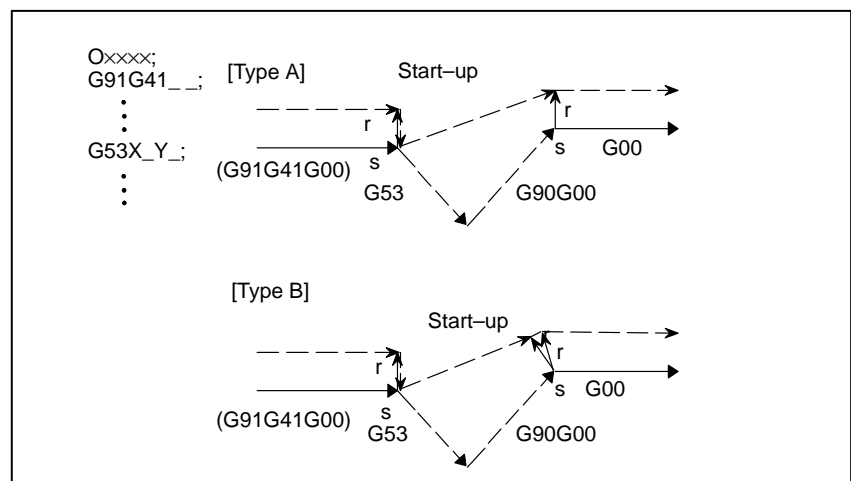
(1) G53 specified in offset mode
 When CCN (bit 2 of parameter No.5003)=0



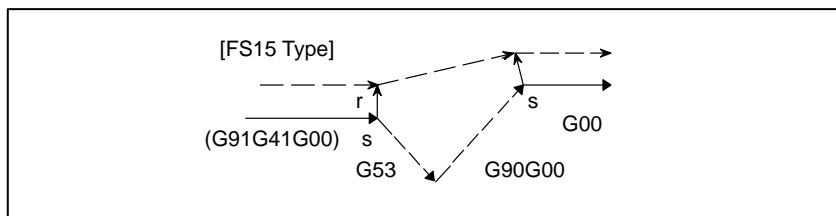
When CCN (bit 2 of parameter No.5003)=1



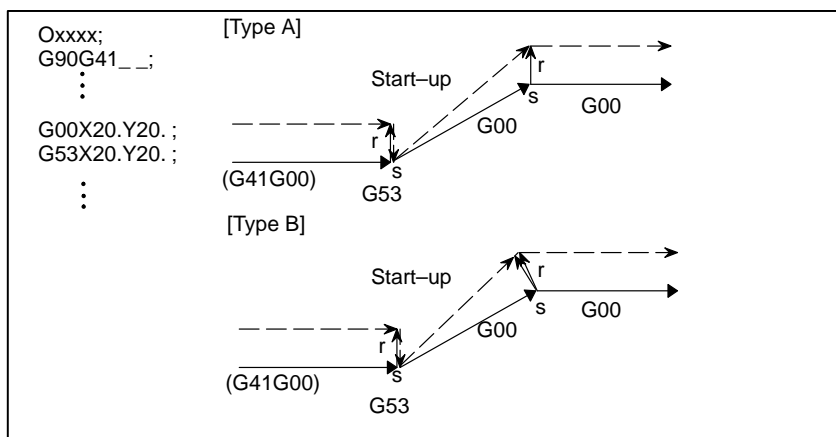
(2) Incremental G53 specified in offset mode
 When CCN (bit 2 of parameter No.5003)=0



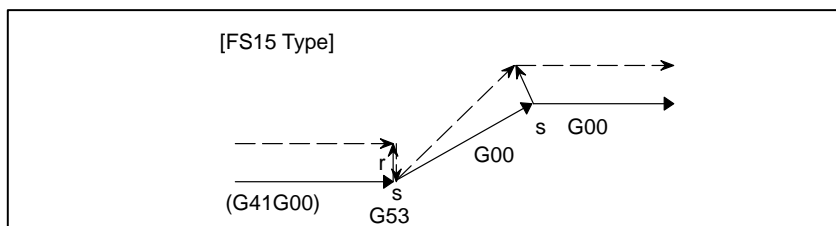
When CCN (bit2 of parameter No.5003)=1



(3) G53 specified in offset mode with no movement specified
When CCN (bit2 of parameter No.5003)=0



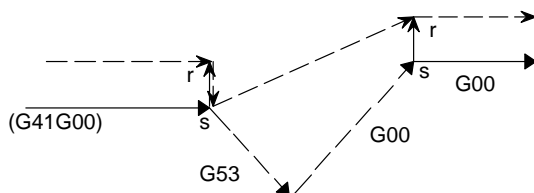
When CCN (bit2 of parameter No.5003)=1



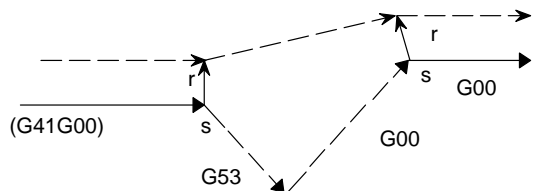
WARNING

1 When cutter compensation C mode is set and all-axis machine lock is applied, the G53 command does not perform positioning along the axes to which machine lock is applied. The vector, however, is preserved. When CCN (bit 2 of parameter No. 5003) is set to 0, the vector is canceled. (Note that even if the FS15 type is used, the vector is canceled when each-axis machine lock is applied.)

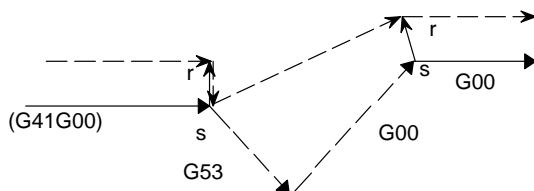
Example 1: When CCN (bit 2 of parameter No. 5003) = 0, type A is used, and all-axis machine lock is applied



Example 2: When CCN (bit 2 of parameter No. 5003) = 1 and all-axis machine lock is applied [FS15 type]

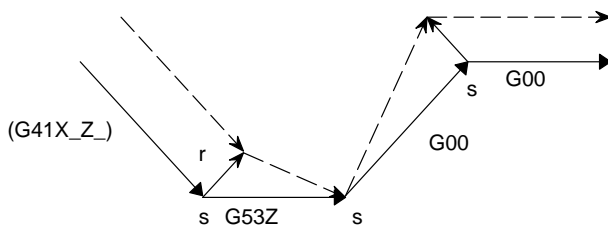


Example 3: When CCN (bit 2 of parameter No. 5003) = 1 and specified-axis machine lock is applied [FS15 type]



2 When G53 is specified for a compensation axis in cutter compensation mode, the vectors along the other axes are also canceled. (This also applies when CCN (bit 2 of parameter No.5003) is set to 1. When the FS15 type is used, only the vector along a specified axis is canceled. Note that the FS15 type cancellation differs from the actual FS15 specification in this point.)

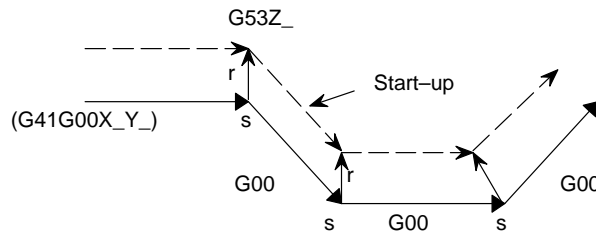
Example: When CCN (bit 2 of parameter No.5003)=1[FS 15 type]



NOTE

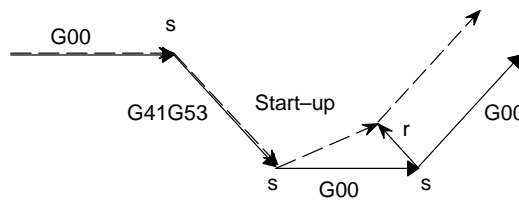
- 1 When a G53 command specifies an axis that is not in the cutter compensation C plane, a perpendicular vector is generated at the end point of the previous block, and the tool does not move. In the next block, offset mode is automatically resumed (in the same way as when two or more continuous blocks do not specify any move commands).

Example: When CCN (bit 2 of parameter No. 5003) = 0, and type A is used



- 2 When a G53 block is specified to become a start-up block, the next block actually becomes the start-up block. When CCN (bit 2 of parameter No. 5003) is set to 1, an intersection vector is generated.

Example: When CCN (bit 2 of parameter No. 5003) = 0 and type A is used



● **G28, G30, or G30.1 command in cutter compensation C mode**

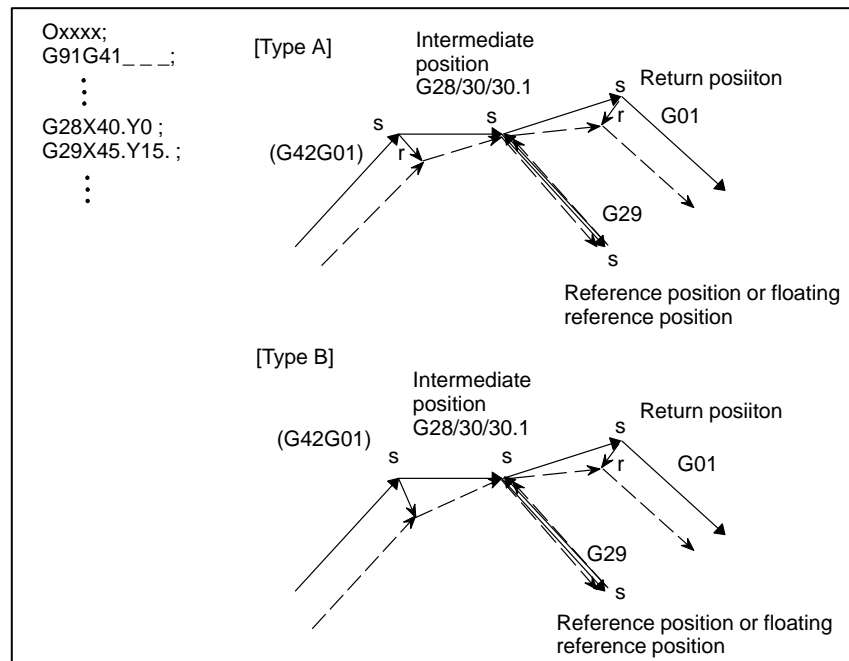
When G28, G30, or G30.1 is specified in cutter compensation C mode, an operation of FS15 type is performed if CCN (bit 2 of parameter No. 5003) is set to 1.

This means that an intersection vector is generated in the previous block, and a perpendicular vector is generated at an intermediate position. Offset vector cancellation is performed when movement is made from the intermediate position to the reference position. As part of restoration, an intersection vector is generated between a block and the next block.

(1) G28, G30, or G30.1, specified in offset mode (with movement to both an intermediate position and reference position performed)

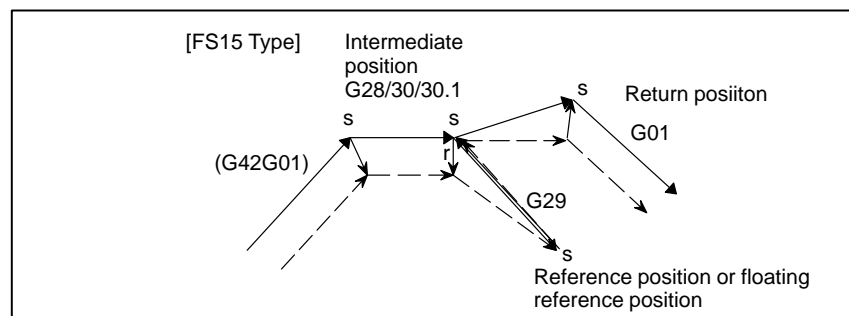
(a) For return by G29

When CCN (bit 2 of parameter No. 5003) = 0



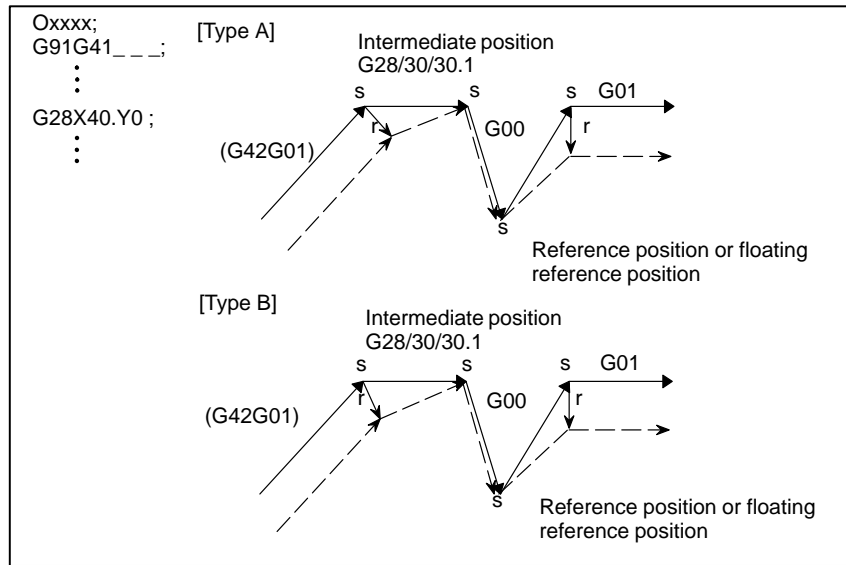
● **G29 command in cutter compensation C mode**

When CCN (bit 2 of parameter No. 5003) = 1

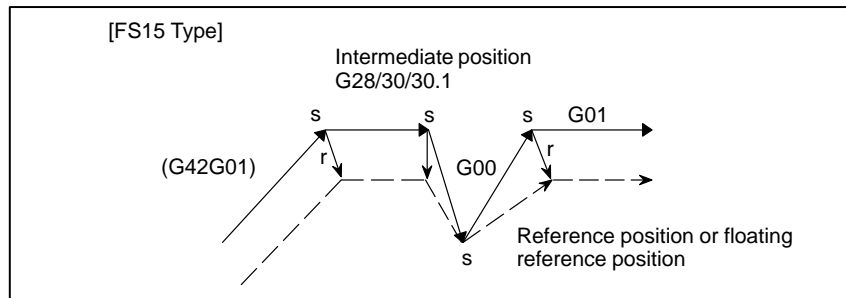


(b) For return by G00

When CCN (bit 2 of parameter No. 5503) = 0



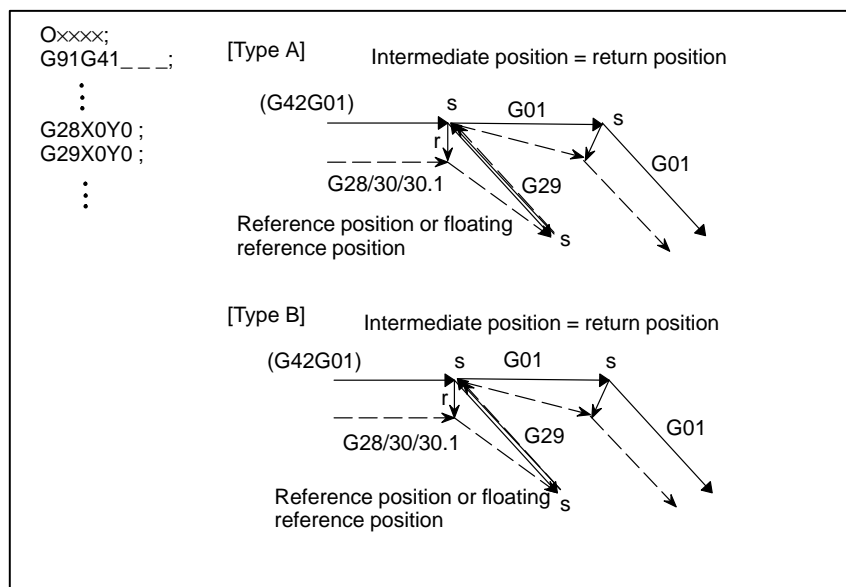
When CCN (bit 2 of parameter No. 5503) = 1



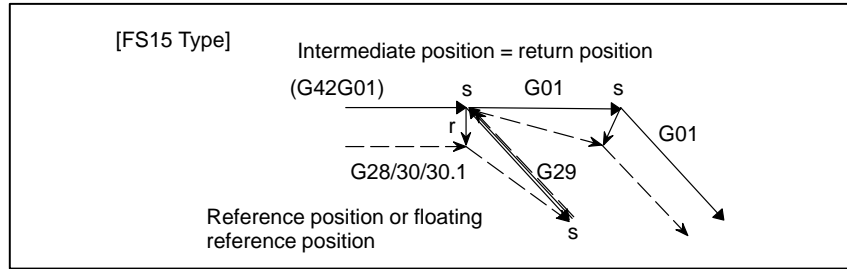
(2) G28, G30, or G30.1, specified in offset mode (with movement to an intermediate position not performed)

(a) For return by G29

When CCN (bit 2 of parameter No. 5503) = 0

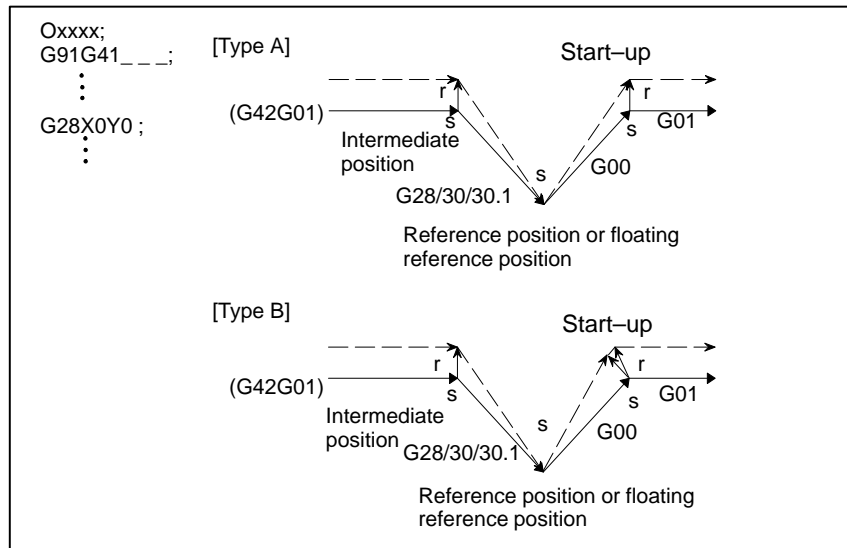


When CCN (bit 2 of parameter No. 5503) = 1

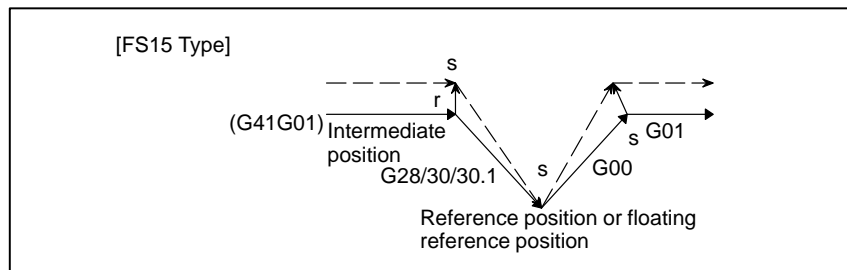


(b) For return by G00

When CCN (bit 2 of parameter No.5503)=0



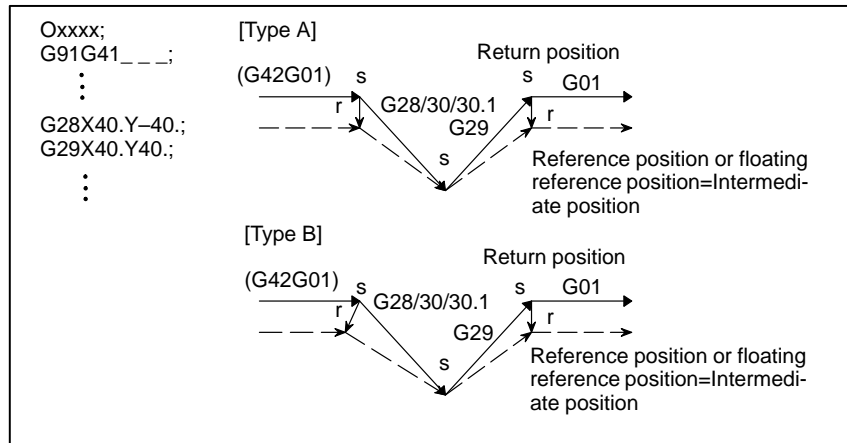
When CCN (bit 2 of parameter No.5503)=1



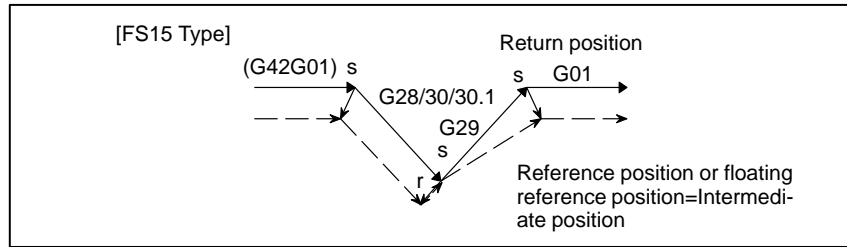
(3) G28, G30, or G30.1, specified in offset mode
(with movement to a reference position not performed)

(a) For return by G29

When CCN (bit 2 of parameter No.5503)=0

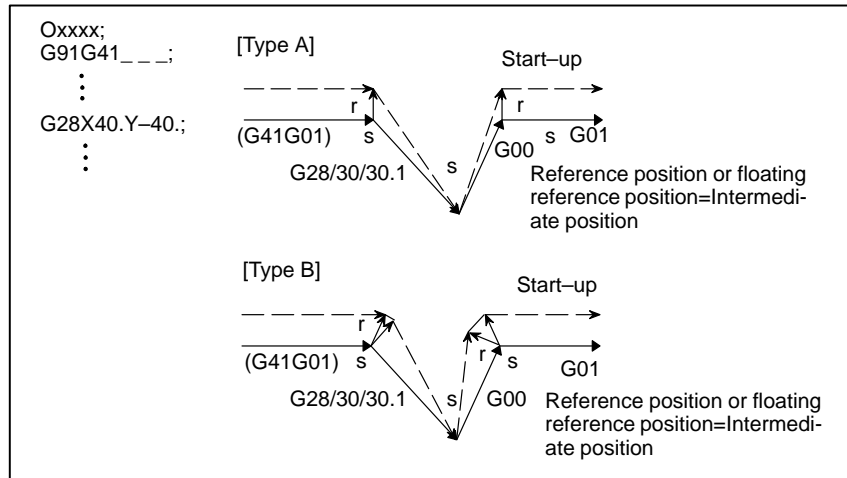


When CCN (bit 2 of parameter No.5503)=1

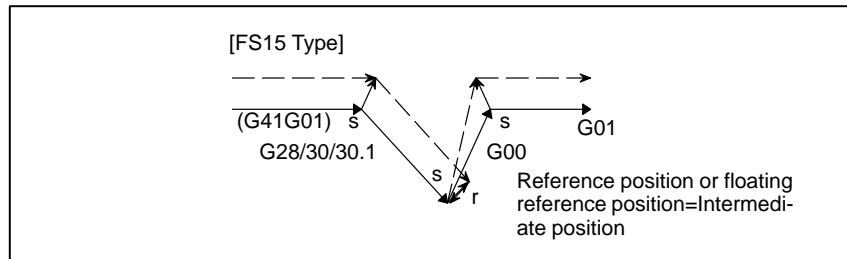


(b) For return by G00

When CCN (bit 2 of parameter No.5503)=0



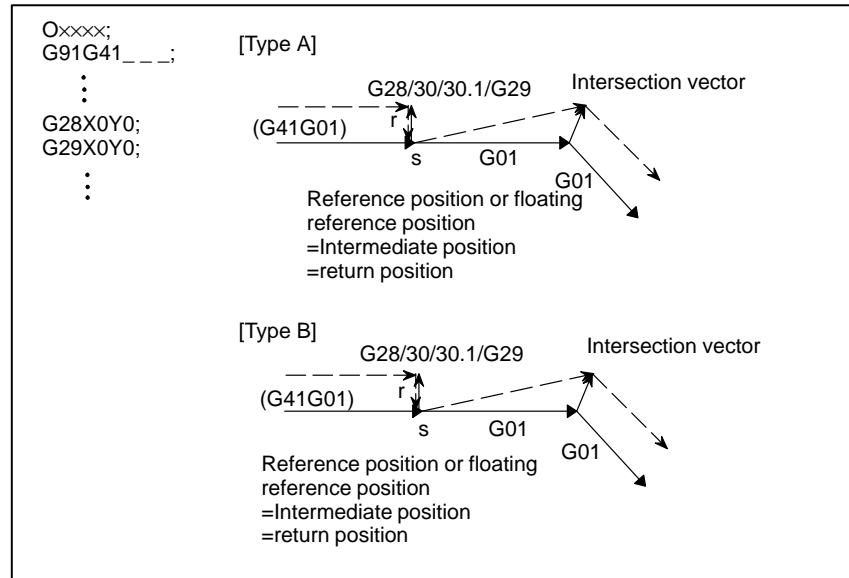
When CCN (bit 2 of parameter No.5503)=1



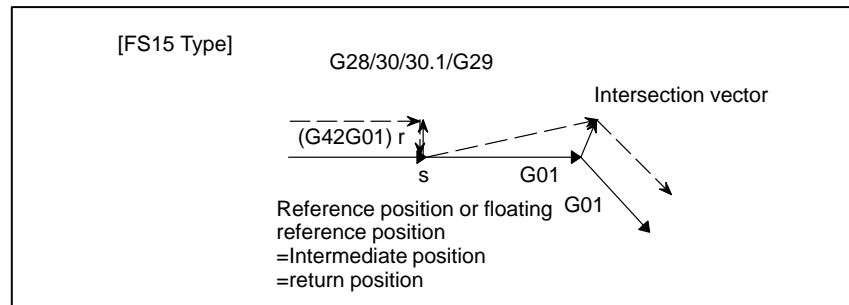
(4) G28, G30, or G30.1 specified in offset mode (with no movement performed)

(a) For return by G29

When CCN (bit 2 of parameter No.5503)=0

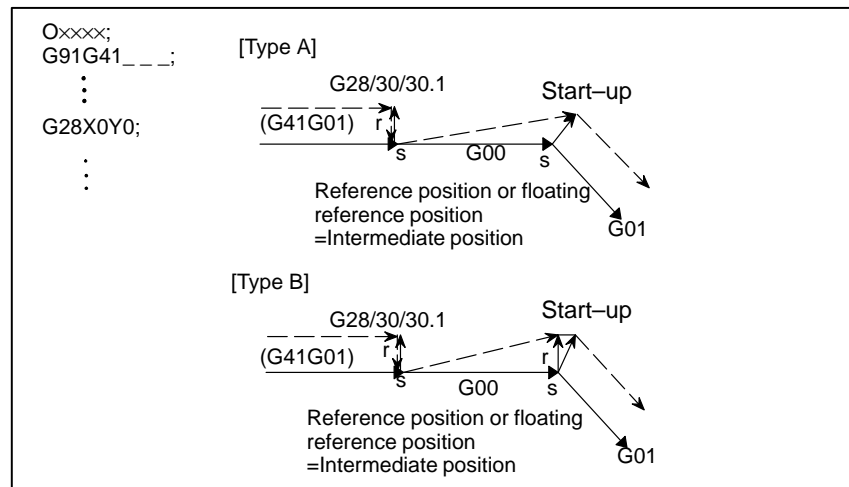


When CCN (bit 2 of parameter No.5503)=1

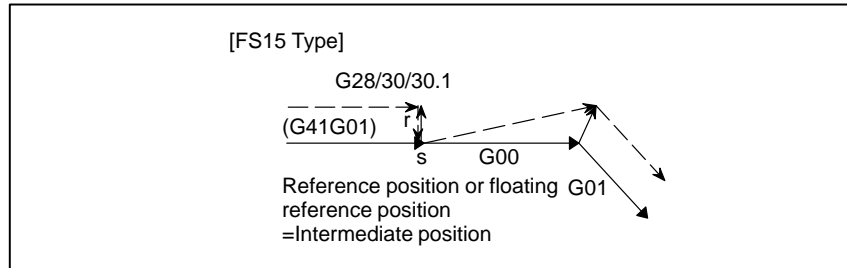


(b) For return by G00

When CCN (bit 2 of parameter No.5503)=0



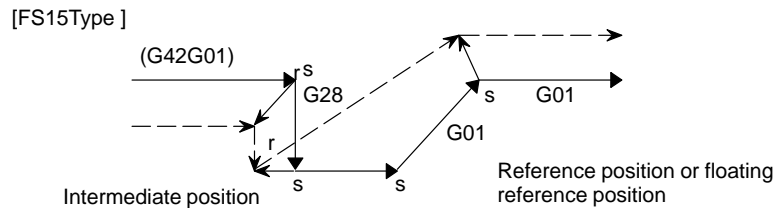
When CCN (bit 2 of parameter No.5503)=1



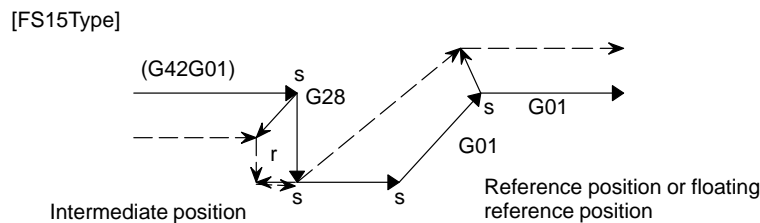
WARNING

1 When a G28, G30, or G30.1 command is specified during all-axis machine lock, a perpendicular offset vector is applied at the intermediate position, and movement to the reference position is not performed; the vector is preserved. Note, however, that even if the FS15 type is used, the vector is canceled only when each-axis machine lock is applied. (The FS15 type preserves the vector even when each-axis machine lock is applied.)

Example1: When CCN (bit 2 of parameter No.5003)=1 and all-axis machine lock is applied

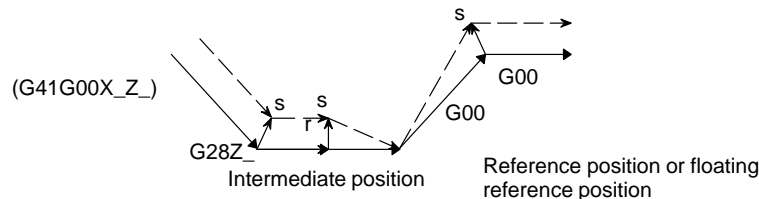


Example2: When CCN (bit 2 of parameter No.5003)=1 and each-axis machine lock is applied



2 When G28, G30, or G30.1 is specified for a compensation axis in cutter compensation mode, the vectors along the other axes are also canceled. (This also applies when CCN (bit 2 of parameter No. 5003) is set to 1. When the FS15 type is used, only the vector along a specified axis is canceled. Note that the FS15 type cancellation differs from the actual FS15 specification in this point.)

Example: When CCN (bit 2 of parameter No.5003)=1

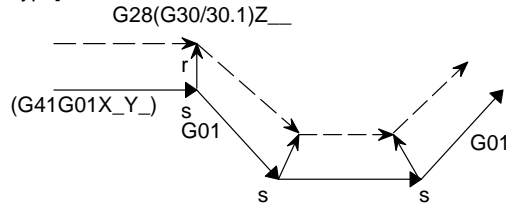


NOTE

1 When a G28, G30, or G30.1 command specifies an axis that is not in the cutter compensation C plane, a perpendicular vector is generated at the end point of the previous block, and the tool does not move. In the next block, offset mode is automatically resumed (in the same way as when two or more continuous blocks do not specify any move commands).

Example: When CCN (bit 2 of parameter No. 5003) = 1

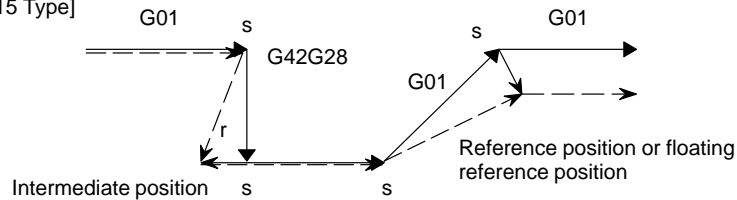
[FS15 Type]



2 When a G28, G30, or G30.1 block is specified such that the block becomes a start-up block, a vector perpendicular to the move direction is generated at an intermediate position, then subsequently canceled at the reference position. In the next block, an intersection vector is generated.

Example: When CCN (bit 2 of parameter No.5003)=1

[FS15 Type]



● **G29 command in cutter compensation C mode**

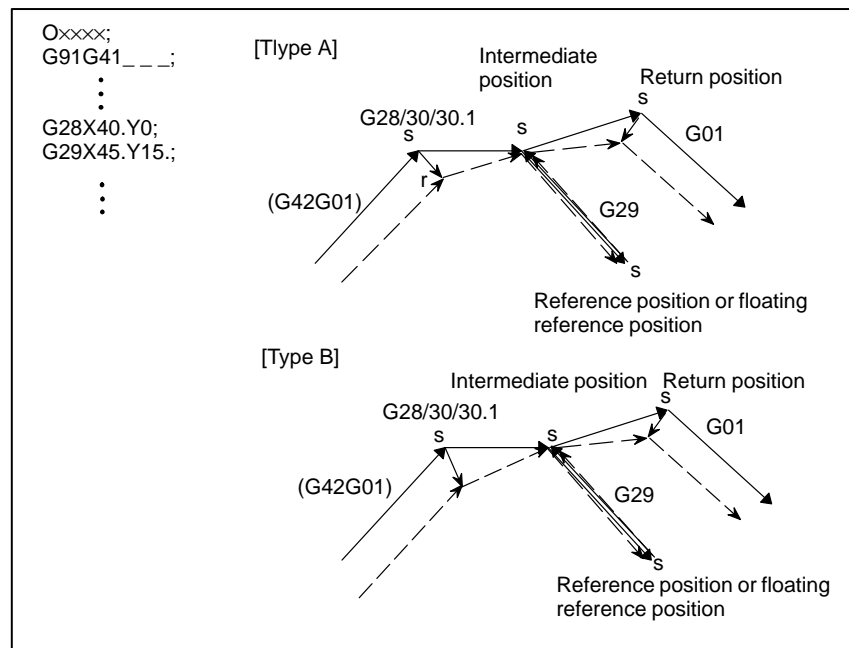
When G29 is specified in cutter compensation C mode, an operation of FS15 type is performed if CCN (bit 2 of parameter No. 5003) is set to 1.

This means that an intersection vector is generated in the previous block, and vector cancellation is performed when a movement to an intermediate position is performed. When movement from the intermediate position to the return position is performed, the vector is restored; an intersection vector is generated between the block and the next block.

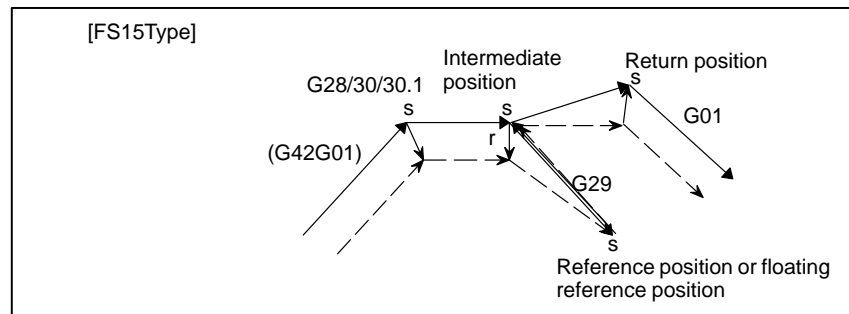
(1) G29 specified in offset mode (with movement to both an intermediate position and reference position performed)

(a) For specification made immediately after automatic reference position return

When CCN (bit 2 of parameter No.5003)=0

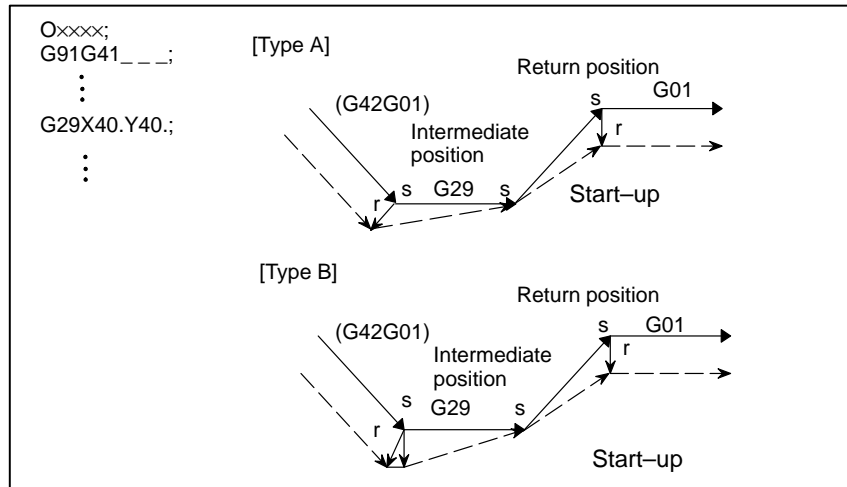


When CCN (bit 2 of parameter No.5003)=1

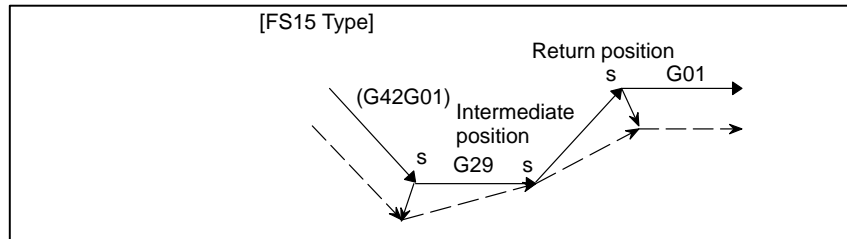


(b) For specification made other than immediately after automatic reference position return

When CCN (bit 2 of parameter No.5003)=0



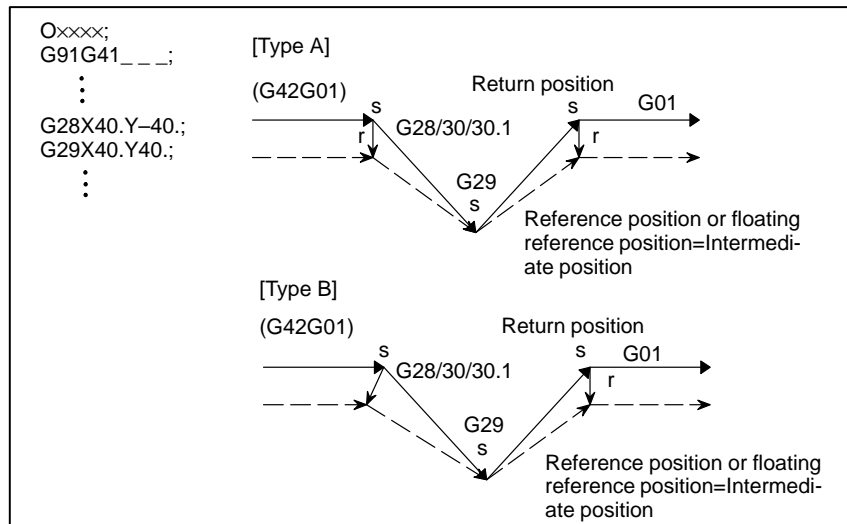
When CCN (bit 2 of parameter No.5003)=1



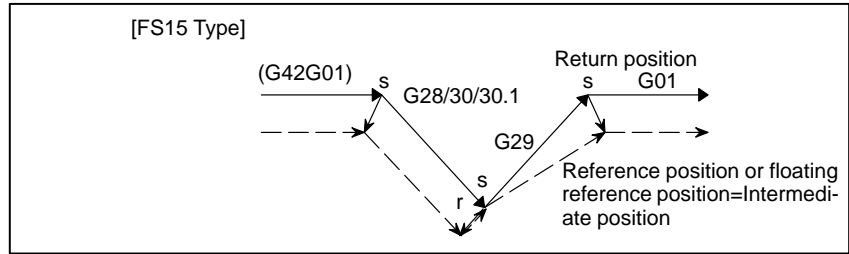
(2) G29 specified in offset mode (with movement to an intermediate position not performed)

(a) For specification made immediately after automatic reference position return

When CCN (bit 2 of parameter No.5003)=0

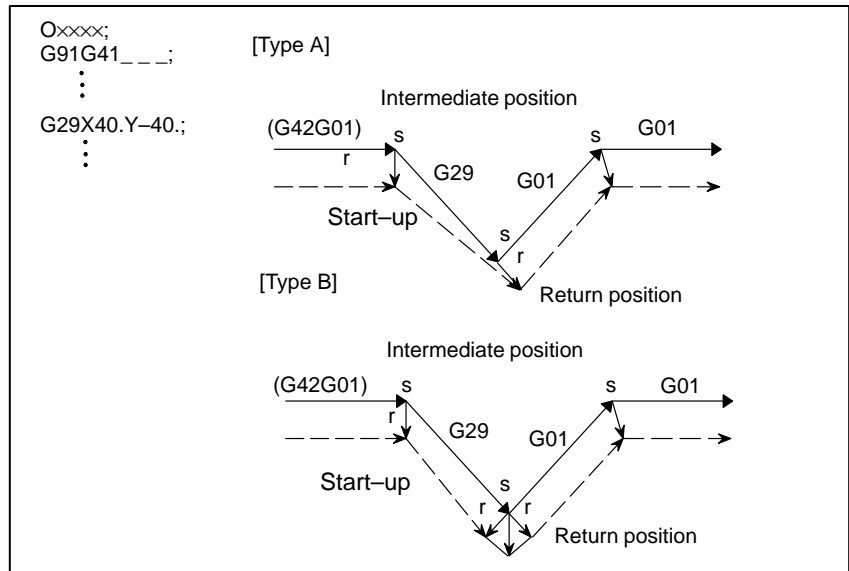


When CCN (bit 2 of parameter No.5003)=1

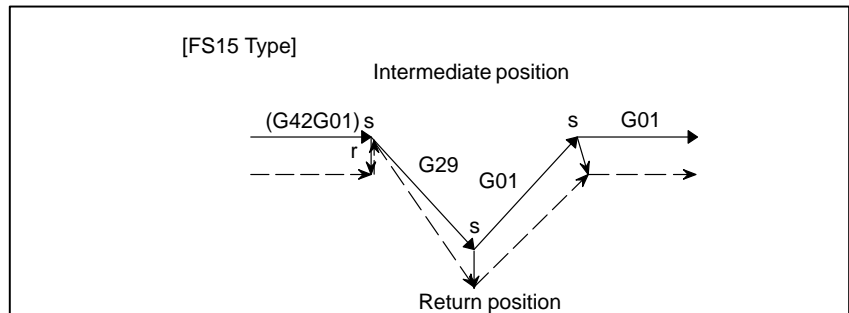


(b) For specification made other than immediately after automatic reference position return

When CCN (bit 2 of parameter No.5003)=0



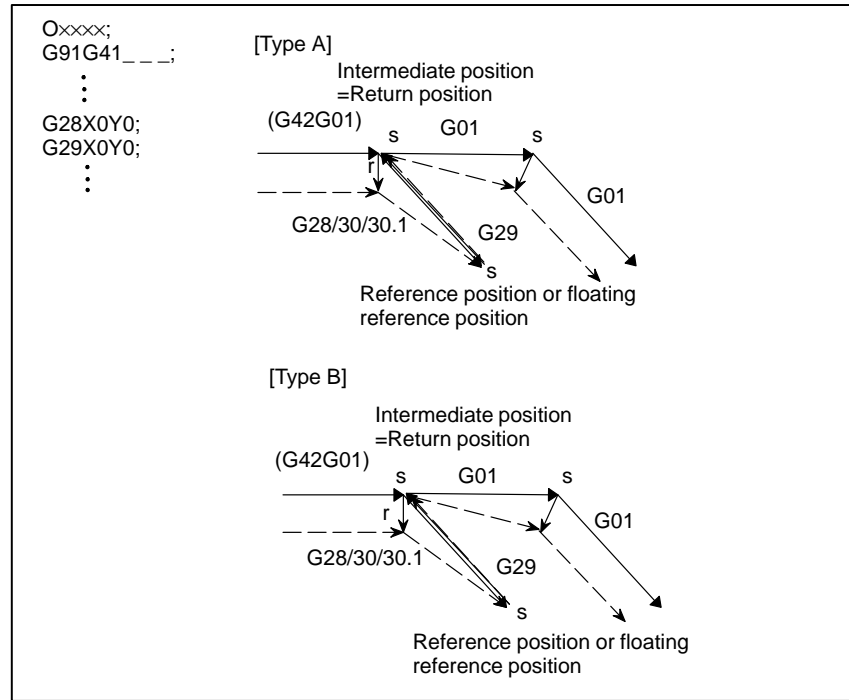
When CCN (bit 2 of parameter No.5003)=1



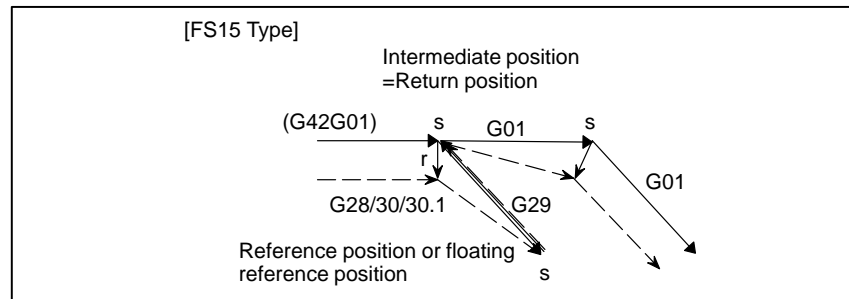
(3) G29 specified in offset mode (with movement to a reference position not performed)

(a) For specification made immediately after automatic reference position return

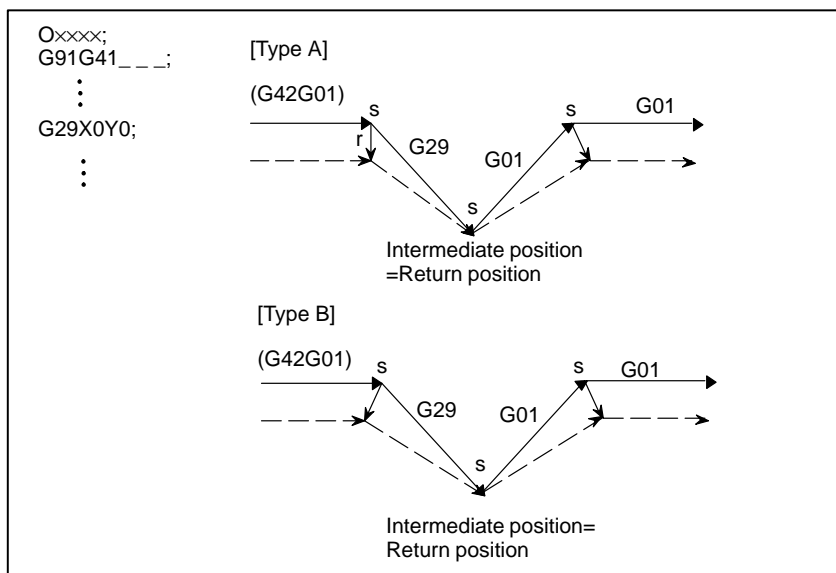
When CCN (bit 2 of parameter No.5003)=0



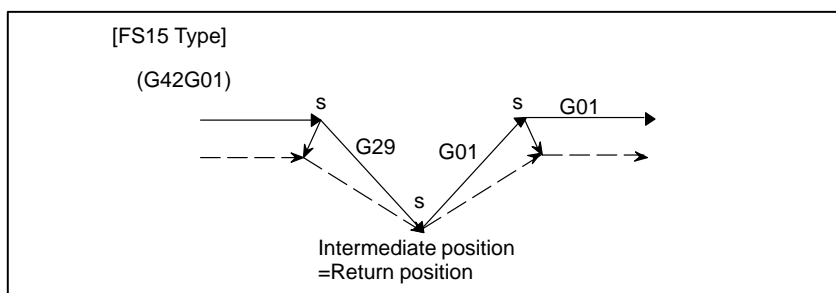
When CCN (bit 2 of parameter No.5003)=1



(b) For specification made other than immediately after automatic reference position return



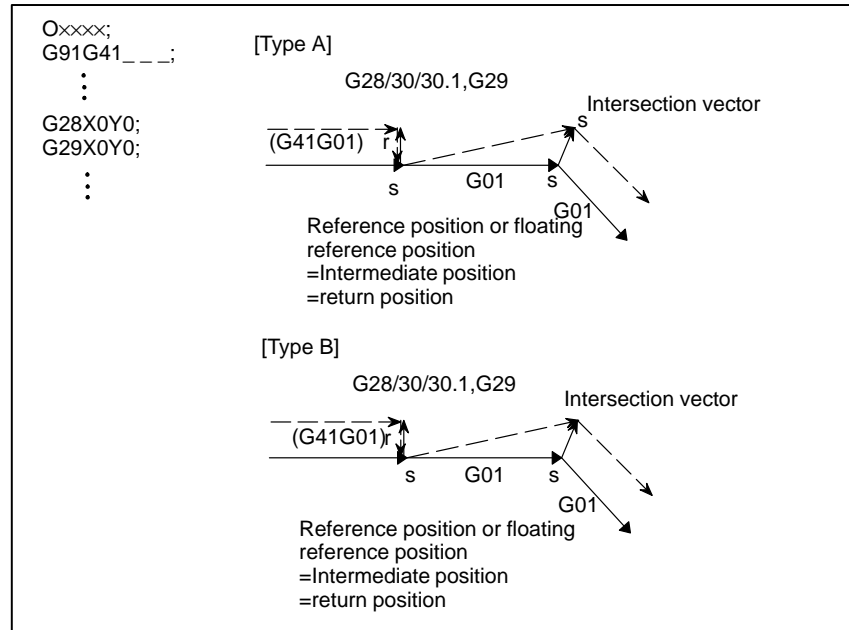
When CCN (bit 2 of parameter No.5003)=1



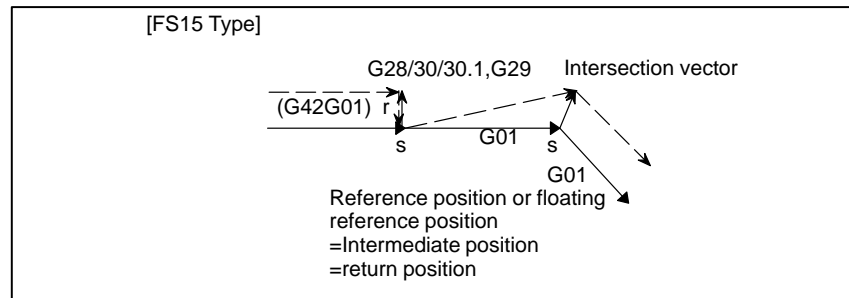
(4) G29 specified in offset mode (with movement to an intermediate position and reference position not performed)

(a) For specification made immediately after automatic reference position return

When CCN (bit 2 of parameter No.5003)=0

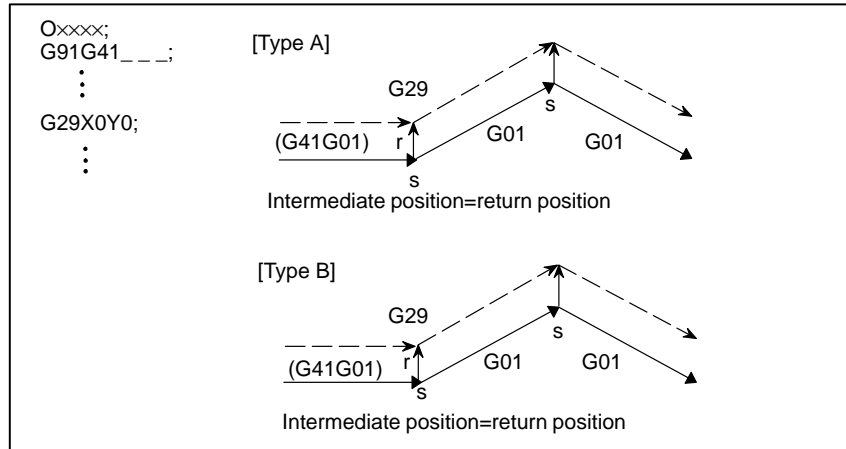


When CCN (bit 2 of parameter No.5003)=1

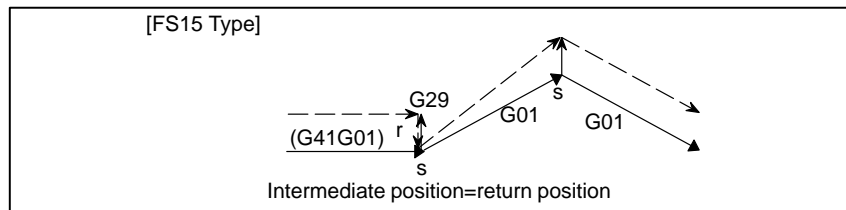


(b) For specification made other than immediately after automatic reference position return

When CCN (bit 2 of parameter No.5003)=0

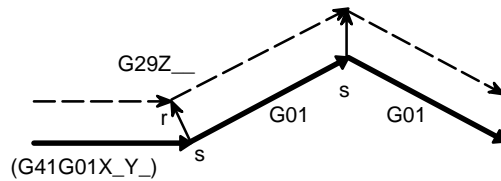


When CCN (bit 2 of parameter No.5003)=1



NOTE

When a G29 command is specified for an axis that is not in the cutter compensation C plane in cutter compensation C mode, a perpendicular vector is generated at the end point of the previous block, and the tool does not move. In the next block, an intersection vector is generated (in the same way as when two or more continuous blocks do not specify any move commands).



14.6.9 Corner Circular Interpolation (G39)

By specifying G39 in offset mode during cutter compensation C, corner circular interpolation can be performed. The radius of the corner circular interpolation equals the compensation value.

Format

<p>In offset mode</p> <p>G39 ;</p> <p>or</p> <p>G39 $\left\{ \begin{array}{l} \underline{I} \underline{J} \\ \underline{I} \underline{K} \\ \underline{J} \underline{K} \end{array} \right\} ;$</p>
--

Explanations

- **Corner circular interpolation**

When the command indicated above is specified, corner circular interpolation in which the radius equals compensation value can be performed. G41 or G42 preceding the command determines whether the arc is clockwise or counterclockwise. G39 is a one-shot G code.

- **G39 without I, J, or K**

When G39; is programmed, the arc at the corner is formed so that the vector at the end point of the arc is perpendicular to the start point of the next block.

- **G39 with I, J, and K**

When G39 is specified with I, J, and K, the arc at the corner is formed so that the vector at the end point of the arc is perpendicular to the vector defined by the I, J, and K values.

Limitations

- **Move command**

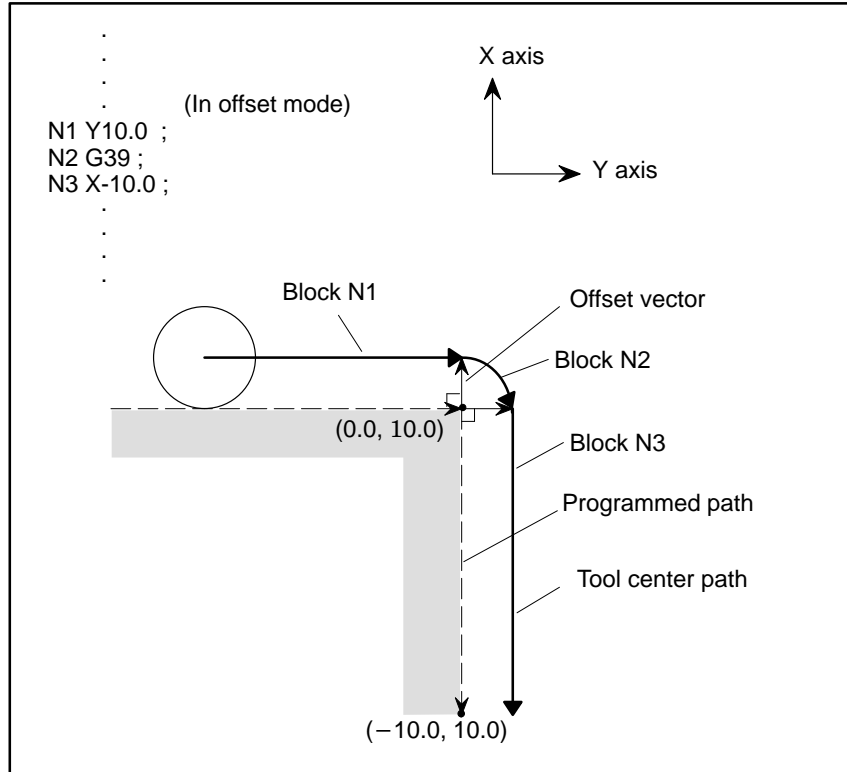
In a block containing G39, no move command can be specified.

- **Non-move command**

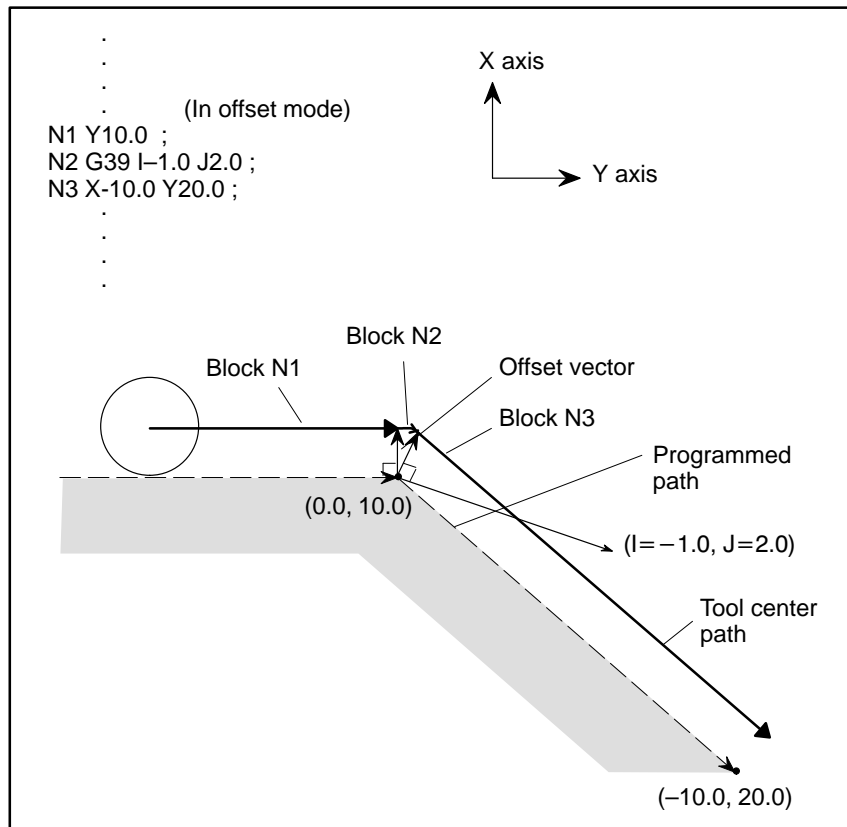
Two or more consecutive non-move blocks must not be specified after a block containing G39 without I, J, or K. (A single block specifying a travel distance of zero is assumed to be two or more consecutive non-move blocks.) If the non-move blocks are specified, the offset vector is temporarily lost. Then, offset mode is automatically restored.

Examples

- G39 without I, J, or K



- G39 with I, J, and K



14.7 THREE- DIMENSIONAL TOOL COMPENSATION (G40, G41)

In cutter compensation C, two-dimensional offsetting is performed for a selected plane. In three-dimensional tool compensation, the tool can be shifted three-dimensionally when a three-dimensional offset direction is programmed.

Format

- **Start up
(Starting three-
dimensional tool
compensation)**

When the following command is executed in the cutter compensation cancel mode, the three-dimensional tool compensation mode is set:

G41 Xp_ Yp_ Zp_ I_ J_ K_ D_ ;

Xp : X-axis or a parallel axis

Yp : Y-axis or a parallel axis

Zp : Z-axis or a parallel axis

I }

J }

K }

See "Explanation".

D : Code for specifying as the cutter compensation value (1-3 digits) (D code)

- **Canceling
three-dimensional tool
compensation**

When the following command is executed in the three-dimensional tool compensation mode, the cutter compensation cancel mode is set:

·When canceling the three-dimensional tool compensation mode and tool movement at the same time

G40 Xp_ Yp_ Zp_ ;

or

Xp_ Yp_ Zp_ D00 ;

·When only canceling the vector

G40;

or

D00;

- **Selecting offset space**

The three-dimensional space where three-dimensional tool compensation is to be executed is determined by the axis addresses specified in the startup block containing the G41 command. If Xp, Yp, or Zp is omitted, the corresponding axis, X-, Y-, or Z-axis (the basic three axis), is assumed.

(Example)

When the U-axis is parallel to the X-axis, the V-axis is parallel to the Y-axis, and the W-axis is parallel to the Z-axis

G41 X_ I_ J_ K_ D_ ; **XYZ space**

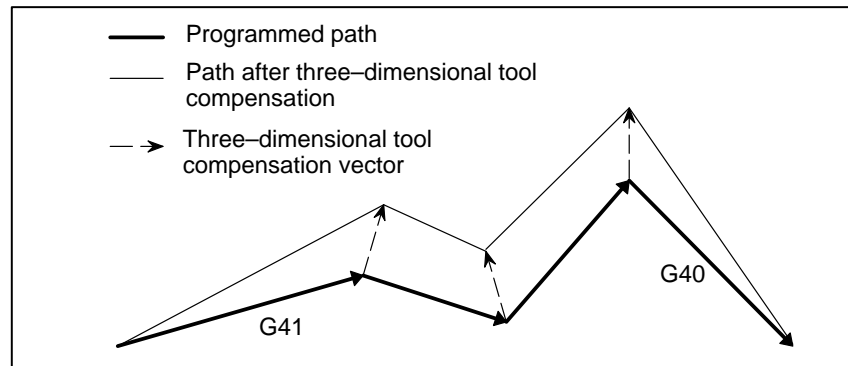
G41 U_ V_ Z_ I_ J_ K_ D_ ; **UVZ space**

G41 W_ I_ J_ K_ D_ ; **XYW space**

Explanations

- **Three-dimensional tool compensation vector**

In three-dimensional tool compensation mode, the following three-dimensional compensation vector is generated at the end of each block:



The three-dimensional tool compensation vector is obtained from the following expressions:

$$V_x = \frac{i \cdot r}{p} \quad (\text{Vector component along the } X_p\text{-axis})$$

$$V_y = \frac{j \cdot r}{p} \quad (\text{Vector component along the } Y_p\text{-axis})$$

$$V_z = \frac{k \cdot r}{p} \quad (\text{Vector component along the } Z_p\text{-axis})$$

In the above expressions, i , j , and k are the values specified in addresses I , J , and K in the block. r is the offset value corresponding to the specified offset number. p is the value obtained from the following expression:

$$p = \sqrt{i^2 + j^2 + k^2}$$

When the user wants to program the magnitude of a three-dimensional tool compensation vector as well as its direction, the value of p in the expressions of V_x , V_y , and V_z can be set as a constant in parameter (No. 5011.) If the parameter is set to 0, however, p is determined as follows:

$$p = \sqrt{i^2 + j^2 + k^2}$$

- **Relationship between three-dimensional tool compensation and other compensation functions**

Tool length offset	The specified path is shifted by three-dimensional tool compensation and the subsequent path is shifted by tool length offset.
Tool offset	When tool offset is specified in the three-dimensional tool compensation mode, an alarm is issued (P/S alarm No. 042).
Cutter compensation C	When addresses I , J , and K are all specified at startup, three-dimensional tool compensation mode is set. When not all of the addresses are specified, cutter compensation C mode is set. Therefore, cutter compensation C cannot be specified in three-dimensional tool compensation mode and three-dimensional tool compensation cannot be specified in cutter compensation C mode.

- **Specifying I, J, and K**

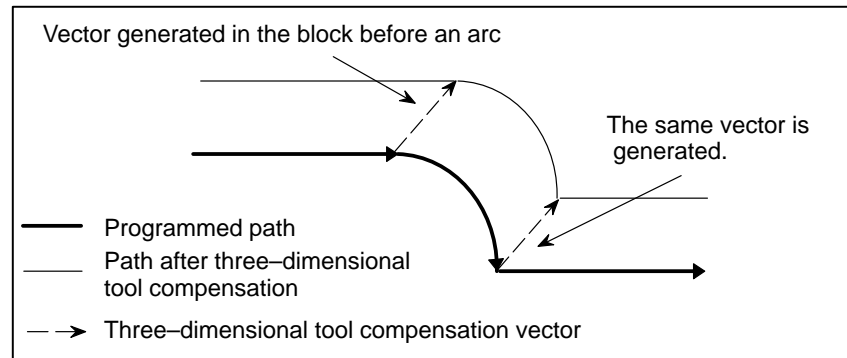
Addresses I, J, and K must all be specified to start three-dimensional tool compensation. When even one of the three addresses is omitted, two-dimensional cutter compensation C is activated. When a block specified in three-dimensional tool compensation mode contains none of addresses I, J, and K, the same vector as the vector generated in the previous block is generated at the end of the block.

- **G42**

Generally, G41 is specified to start three-dimensional tool compensation. Instead of G41, G42 can be specified for startup. With G42, three-dimensional tool compensation is performed in the opposite direction.

- **Offset vector in interpolation**

When circular interpolation, helical interpolation (both specified with G02, G03), or involute interpolation (G02.2, G03.2) is specified, the vector generated in the previous block is maintained.



- **Reference position return check (G27)**

Before specifying reference position return check (G27), cancel three-dimensional tool compensation. In the compensation mode, G27 brings the tool to a position shifted by the offset value. If the position the tool reached is not the reference position, the reference position return LED does not go on (the P/S alarm No.092 alarm is issued).

- **Return to a reference position (G28, G30, G30.1)**

When return to the reference position (G28), to the second, third, or fourth reference position (G30), or to the floating reference position (G30.1) is specified, the vector is cleared at a middle point.

- **Alarm issued at startup**

If one of the following conditions is present at the startup of three-dimensional tool compensation, an alarm is issued:

- Two or more axes are specified in the same direction. (P/S alarm No.047)
- Although Xp, Yp, or Zp is omitted, the basic three axes are not set. (P/S alarm No.048)

- **Alarm during three-dimensional tool compensation**

If one of the following G codes is specified in the three-dimensional tool compensation mode, an alarm is issued:

- G05 High-speed cycle machining (P/S alarm178)
- G31 Skip function (P/S alarm 036)
- G51 Scaling (P/S alarm141)

- **Commands that clear the vector**

When one of the following G codes is specified in three-dimensional tool compensation mode, the vector is cleared:

- G73 Peck drilling cycle
- G74 Reverse tapping cycle
- G76 Fine boring
- G80 Canned cycle cancel
- G81 Drill cycle, spot boring
- G82 Drill cycle, counterboring
- G83 Peck drilling cycle
- G84 Tapping cycle
- G85 Boring cycle
- G86 Boring cycle
- G87 Back boring cycle
- G88 Boring cycle
- G89 Boring cycle
- G53 Machine coordinate system selection

- **Commands that generate the same vector as the vector in the previous block**

When one of the following G codes is specified in three-dimensional tool compensation mode, the same vector as the vector generated in the previous block is generated at the end point of the next movement:

- G02 Circular or helical interpolation (CW)
- G03 Circular or helical interpolation (CCW)
- G02.2 Involute interpolation (CW)
- G03.2 Involute interpolation (CCW)
- G04 Dwell
- G10 Data setting
- G22 Stored stroke check function enabled

14.8 TOOL COMPENSA- TION VALUES, NUMBER OF COMPENSATION VALUES, AND ENTERING VALUES FROM THE PROGRAM (G10)

Tool compensation values include tool geometry compensation values and tool wear compensation (Fig. 14.8 (a)).

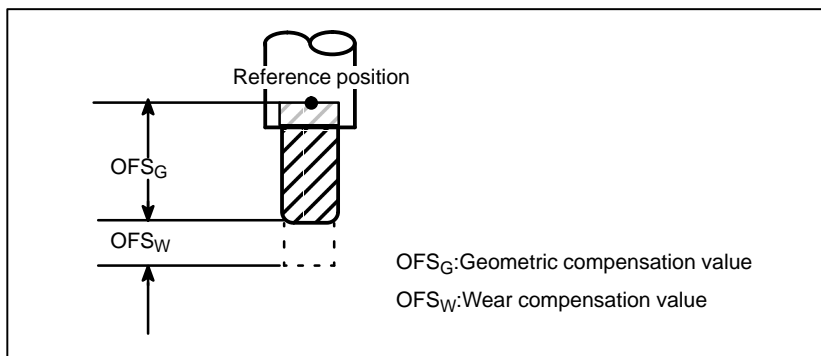


Fig14.8 (a) Geometric compensation and wear compensation

Tool compensation values can be entered into CNC memory from the CRT/MDI panel (see section III-11.4.1) or from a program. A tool compensation value is selected from the CNC memory when the corresponding code is specified after address H or D in a program. The value is used for tool length compensation, cutter compensation, or the tool offset.

Explanations

- Valid range of tool compensation values

Table 14.8(a) shows the valid input range of tool compensation values.

Table14.8 (a) The valid input range of tool compensation value

In-crement sys-tem	Geometric compensation value		Wear compensation value	
	Metric input	Inch input	Metric input	Inch input
IS-B	± 999.999 mm	± 99.9999inch	± 99.999 mm	± 9.9999 inch
IS-C	± 999.9999 mm	± 99.99999inch	± 99.9999 mm	± 9.99999 inch

- Number of tool compensation values and the addresses to be specified

The memory can hold 32, 64, 99, 200, 400, 499, or 999 tool compensation values (option).

Address D or H is used in the program. The address used depends on which of the following functions is used: tool length compensation(see II-14.1), tool offset (see II-14.3), cutter compensation B (see II- 14.4), or cutter compensation C (see II-14.6).

The range of the number that comes after the address (D or H) depends on the number of tool compensation values : 0 to 32, 0 to 64, 0 to 99, 0 to 200, 0 to 400, 0 to 499, or 0 to 999.

- **Tool compensation memory and the tool compensation value to be entered**

Tool compensation memory A, B, or C can be used.

The tool compensation memory determines the tool compensation values that are entered (set) (Table 14.8 (b)).

Table14.8 (b) Setting contents tool compensation memory and tool compensation value

Tool compensation value	Tool compensation memory A	Tool compensation memory B	Tool compensation memory C
Tool geometry compensation value for address D	Set tool geometry + tool wear compensation values for addresses D and H (values can be specified with either address).	Set tool geometry compensation values for addresses D and H (values can be specified with either address).	set
Tool geometry compensation value for address H			set
Tool wear compensation for value address D		Set tool wear compensation values for addresses D and H (values can be specified with either address).	set
Tool wear compensation value for address H			set

- **Format**

The programming format depends on which tool compensation memory is used.

- **Input of tool compensation value by programming**

Table14.8 (c) Setting range of Tool compensation memory and Tool compensation value

Variety of tool compensation memory		Format
A	Tool compensation value (geometry compensation value+wear compensation value)	G10L11P_R_;
B	Geometry compensation value	G10L10P_R_;
	Wear compensation value	G10L11P_R_;
C	Geometry compensation value for H code	G10L10P_R_;
	Geometry compensation value for D code	G10L12P_R_;
	Wear compensation value for H code	G10L11P_R_;
	Wear compensation value for D code	G10L13P_R_;

P : Number of tool compensation

R : Tool compensation value in the absolute command(G90) mode

Value to be added to the specified tool compensation value in the incremental command(G91) mode (the sum is also a tool compensation value.)

NOTE

To provide compatibility with the format of older CNC programs, the system allows L1 to be specified instead of L11.

14.9 SCALING (G50,G51)

A programmed figure can be magnified or reduced (scaling).
 The dimensions specified with X_, Y_, and Z_ can each be scaled up or down with the same or different rates of magnification.
 The magnification rate can be specified in the program.
 Unless specified in the program, the magnification rate specified in the parameter is applied.

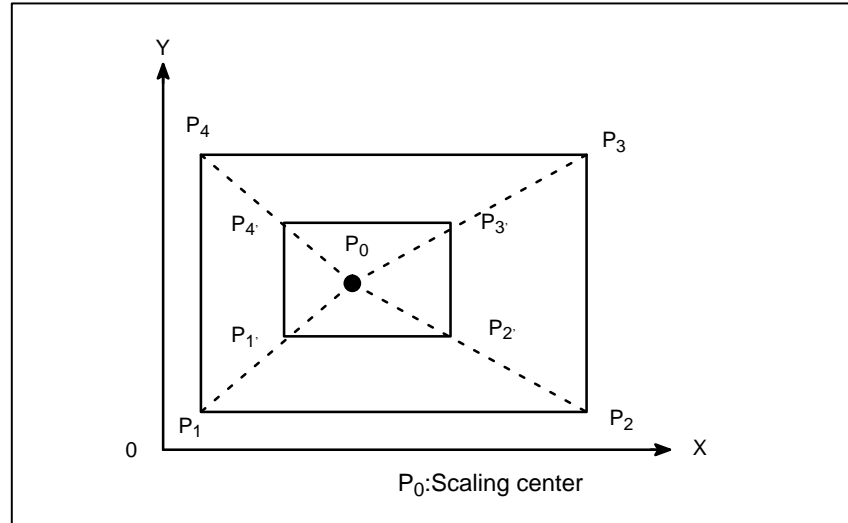


Fig.14.9 (a) Scaling(P₁ P₂ P₃ P₄→P₁'P₂'P₃'P₄')
 P₀:Scaling center

Format

SCALING UP OR DOWN ALONG ALL AXES AT THE SAME RATE OF MAGNIFICATION	
Format	Meaning of command
G51X_Y_Z_P_ ; Scaling start	X_Y_Z_ : Absolute command for center coordinate value of scaling P_ : Scaling magnification
⋮ } Scaling is effective. (Scaling mode)	
G50 ; Scaling cancel	

Scaling up or down along each axes at a different rate of magnification (mirror image)	
Format	Meaning of command
G51_X_Y_Z_I_J_K_;Scaling start	X_Y_Z_ Absolute command for center coordinate value of scaling I_J_K_ Scaling magnification for X axis Y axis and Z axis respectively
⋮ } Scaling is effective. (Scaling mode)	
G50 Scaling cancel	

WARNING
 Specify G51 in a separate block. After the figure is enlarged or reduced, specify G50 to cancel the scaling mode.

Explanations

- **Scaling up or down along all axes at the same rate of magnification**

Least input increment of scaling magnification is: 0.001 or 0.00001 It is depended on parameter SCR (No. 5400#7) which value is selected. If scaling P is not specified on the block of scaling (G51X_Y_Z_P_ ;), the scaling magnification set to parameter (No. 5411) is applicable. If X,Y,Z are omitted, the tool position where the G51 command was specified serves as the scaling center.

- **Scaling of each axis, programmable mirror image (negative magnification)**

Each axis can be scaled by different magnifications. Also when a negative magnification is specified, a mirror image is applied. First of all, set a parameter XSC (No. 5400#6) which validates each axis scaling (mirror image).

Then, set parameter SCLx (No. 5401#0) to enable scaling along each axis. Least input increment of scaling magnification of each axis (I, J, K) is 0.001 or 0.00001(set parameter SCR (No. 5400#7)).

Magnification is set to parameter 5421 within the range +0.00001 to +9.99999 or +0.001 to +999.999

If a negative value is set, mirror image is effected.

If magnification I, J or K is not commanded, a magnification value set to parameter (No. 5421) is effective. However, a value other than 0 must be set to the parameter.

NOTE

Decimal point programming can not be used to specify the rate of magnification (I, J, K).

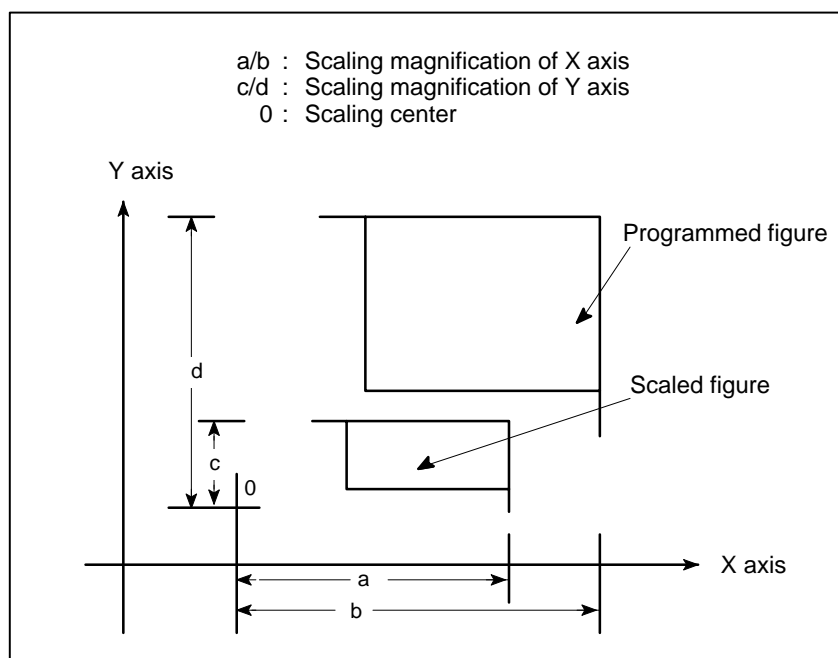


Fig14.9 (b) Scaling of each axis

- **Scaling of circular interpolation**

Even if different magnifications are applied to each axis in circular interpolation, the tool will not trace an ellipse.

When different magnifications are applied to axes and a circular interpolation is specified with radius R, it becomes as following figure 14.9 (c) (in the example shown below, a magnification of 2 is applied to the X-component and a magnification of 1 is applied to the Y-component.).

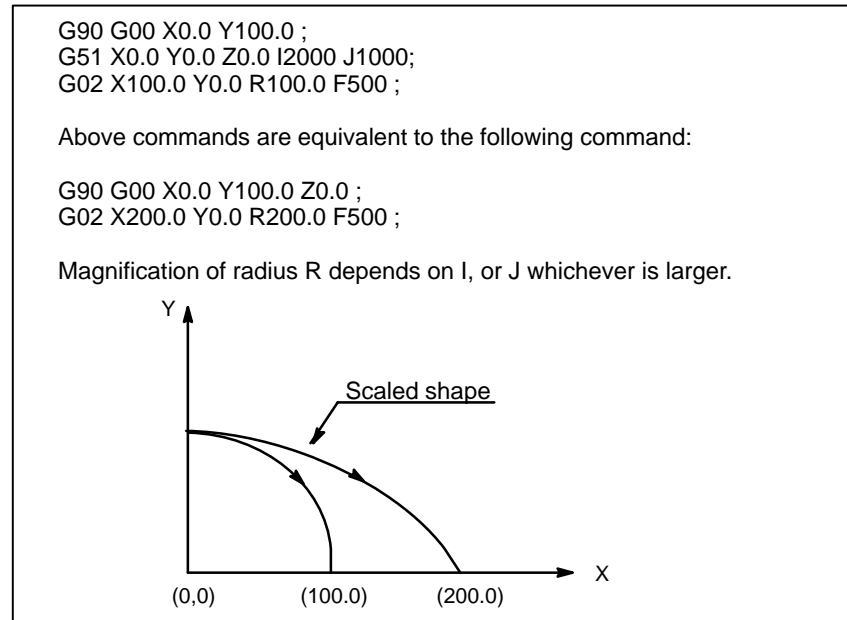


Fig14.9 (c) Scaling for circular interpolation1

When different magnifications are applied to axes and a circular interpolation is specified with I, J and K, it becomes as following figure 14.9 (d) (In the example shown below, a magnification of 2 is applied to the X-component and a magnification of 1 is applied to the Y-component.).

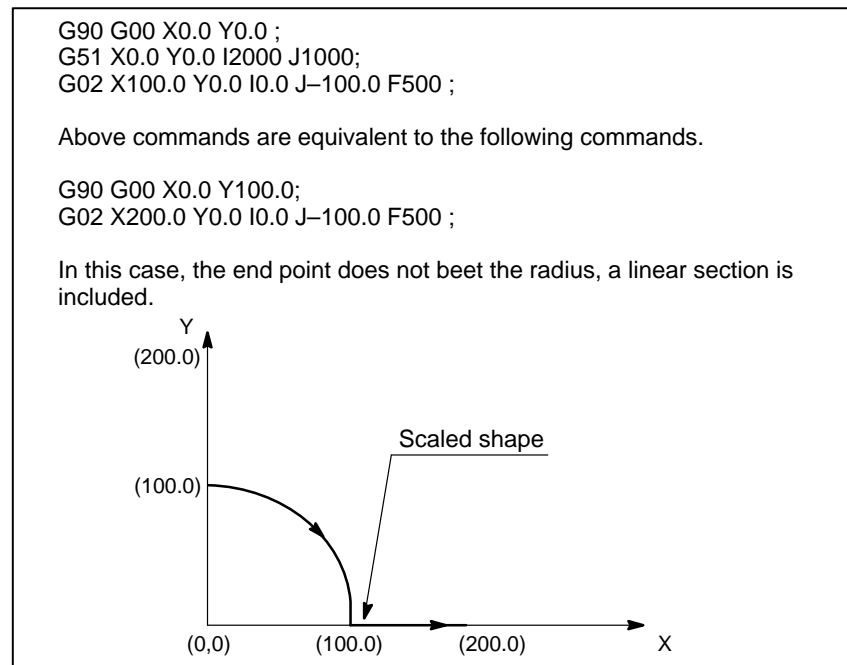


Fig14.9 (d) Scaling for circular interpolation 2

- **Tool compensation**

This scaling is not applicable to cutter compensation values, tool length offset values, and tool offset values (Fig. 14.9 (e)).

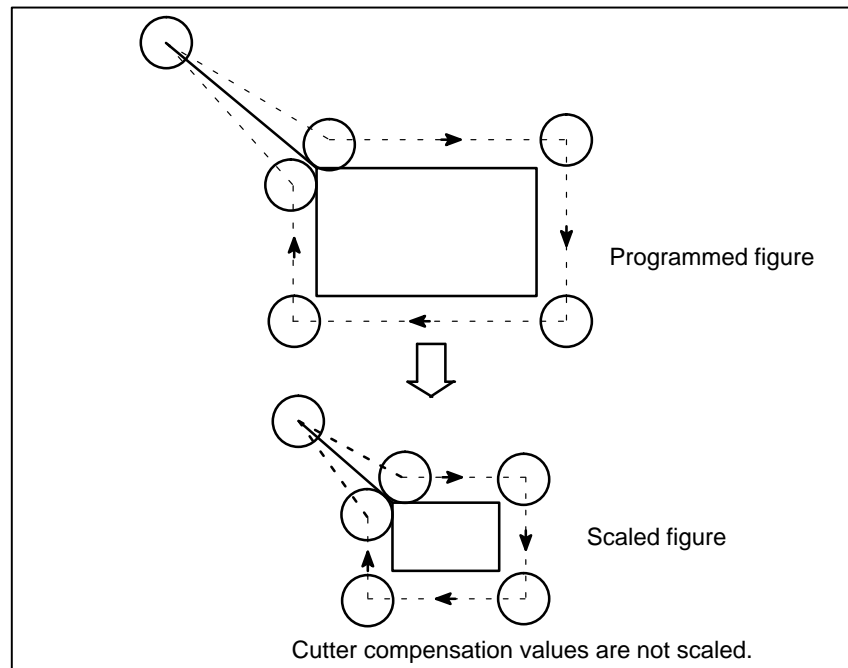


Fig14.9(e) Scaling during cutter compensation

- **Invalid scaling**

Scaling is not applicable to the Z-axis movement in case of the following canned cycle.

- Cut-in value Q and retraction value d of peck drilling cycle (G83, G73).
- Fine boring cycle (G76)
- Shift value Q of X and Y axes in back boring cycle (G87).

In manual operation, the travel distance cannot be increased or decreased using the scaling function.

- **Commands related to reference position return and coordinate system**

In scaling mode, G28, G30, or commands related to the coordinate system (G52 to G59) must not be specified. When any of these G codes is necessary, specify it after canceling scaling mode.

WARNING

- 1 If a parameter setting value is employed as a scaling magnification without specifying P, the setting value at G51 command time is employed as the scaling magnification, and a change of this value, if any, is not effective.
- 2 Before specifying the G code for reference position return (G27, G28, G29, G30) or coordinate system setting (G92), cancel the scaling mode.
- 3 If scaling results are rounded by counting fractions of 5 and over as a unit and disregarding the rest, the move amount may become zero. In this case, the block is regarded as a no movement block, and therefore, it may affect the tool movement by cutter compensation C. See the description of blocks that do not move the tool at II-14.6.3.

NOTE

- 1 The position display represents the coordinate value after scaling.
- 2 When a mirror image was applied to one axis of the specified plane, the following results:
 - (1) Circular command Direction of rotation is reversed.
 - (2) Cutter compensation C Offset direction is reversed.
 - (3) Coordinate system rotation Rotation angle is reversed.
 - (4) Cutter compensation B Offset direction is reversed. (Including G39)

Examples

Example of a mirror image program

Subprogram

```
O9000 ;
G00 G90 X60.0 Y60.0;
G01 X100.0 F100;
G01 Y100.0;
G01 X60.0 Y60.0;
M99;
```

Main program

```
N10 G00 G90;
N20 M98 P9000;
N30 G51 X50.0 Y50.0 I-1000 J1000;
N40 M98 P9000;
N50 G51 X50.0 Y50.0 I-1000 J-1000;
N60 M98 P9000;
N70 G51 X50.0 Y50.0 I1000 J-1000;
N80 M98 P9000;
N90 G50;
```

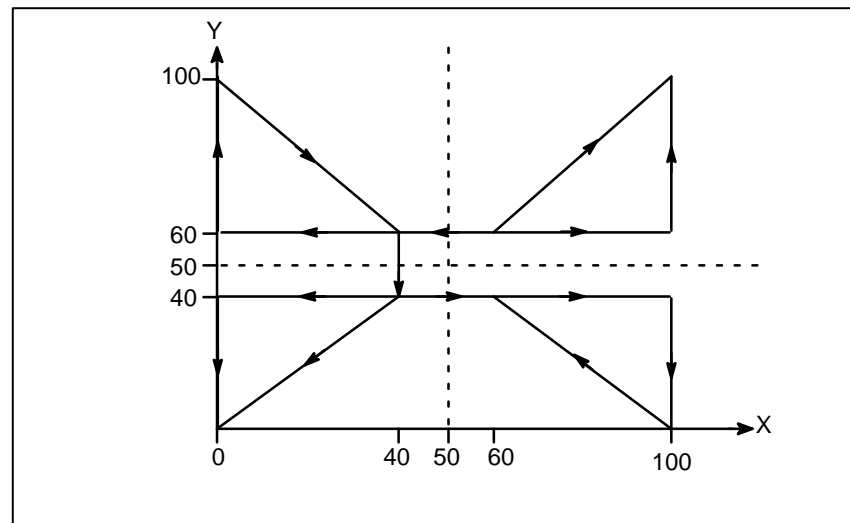


Fig14.9(f) Example of a mirror image program

14.10 COORDINATE SYSTEM ROTATION (G68, G69)

A programmed shape can be rotated. By using this function it becomes possible, for example, to modify a program using a rotation command when a workpiece has been placed with some angle rotated from the programmed position on the machine. Further, when there is a pattern comprising some identical shapes in the positions rotated from a shape, the time required for programming and the length of the program can be reduced by preparing a subprogram of the shape and calling it after rotation.

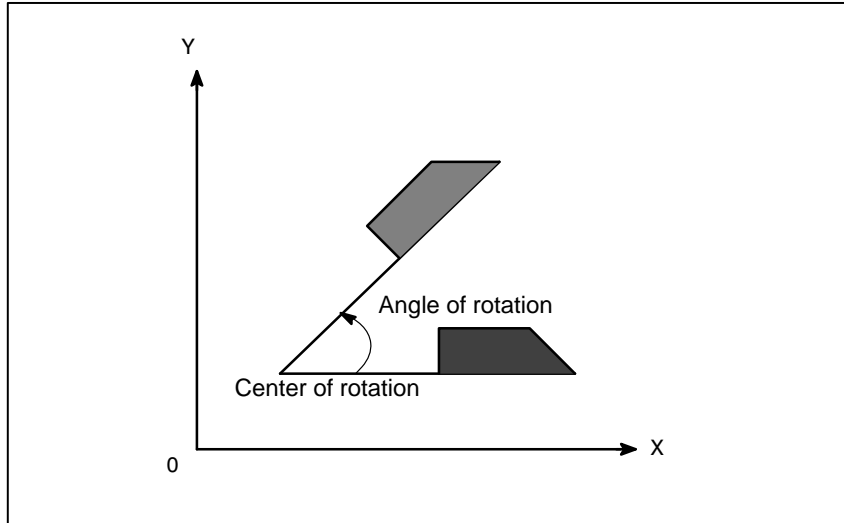


Fig14.10 (a) Coordinate system rotation

Format

Format	
$\left. \begin{matrix} \text{G17} \\ \text{G18} \\ \text{G19} \end{matrix} \right\} \text{G68 } \alpha_ \beta_ \text{R}_\text{ ; Start rotation of a coordinate system.}$ G69 ;	$\left. \begin{matrix} \text{Coordinate system rotation mode} \\ \text{(The coordinate system is rotated.)} \end{matrix} \right\}$ Coordinate system rotation cancel command
Meaning of command	
G17 (G18 or G19)	: Select the plane in which contains the figure to be rotated.
$\alpha_ \beta_$	Absolute command for two of the $x_ y_ z_ $ axes that correspond to the current plane selected by a command (G17, G18, or G19). The command specifies the coordinates of the center of rotation for the values specified subsequent to G68.
R_	Angular displacement with a positive value indicates counter clockwise rotation. Bit 0 of parameter 5400 selects whether the specified angular displacement is always considered an absolute value or is considered an absolute or incremental value depending on the specified G code (G90 or G91).
Least input increment:	0.001 deg
Valid data range	: -360,000 A360,000

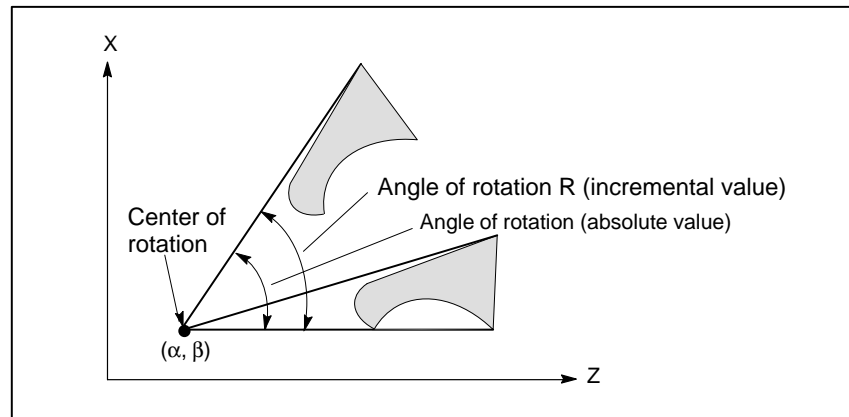


Fig14.10 (b) Coordinate system rotation

NOTE

When a decimal fraction is used to specify angular displacement ($R_{.}$), the 1's digit corresponds to degree units.

Explanations

- **G code for selecting a plane: G17,G18 or G19**

The G code for selecting a plane (G17,G18,or G19) can be specified before the block containing the G code for coordinate system rotation (G68). G17, G18 or G19 must not be designated in the mode of coordinate system rotation.

- **Incremental command in coordinate system rotation mode**

The center of rotation for an incremental command programmed after G68 but before an absolute command is the tool position when G68 was programmed (Fig. 14.10 (c)).

- **Center of rotation**

When α_{β} is not programmed, the tool position when G68 was programmed is assumed as the center of rotation.

- **Angular displacement**

When $R_{.}$ is not specified, the value specified in parameter 5410 is assumed as the angular displacement.

- **Coordinate system rotation cancel command**

The G code used to cancel coordinate system rotation (G69) may be specified in a block in which another command is specified.

- **Tool compensation**

Cutter compensation, tool length compensation, tool offset, and other compensation operations are executed after the coordinate system is rotated.

- **Relationship with three-dimensional coordinate conversion (G68, G69)**

Both coordinate system rotation and three-dimensional coordinate conversion use the same G codes: G68 and G69. The G code with I, J, and K is processed as a command for three-dimensional coordinate conversion. The G code without I, J, and K is processed as a command for two-dimensional coordinate system rotation.

Limitations

- **Commands related to reference position return and the coordinate system**
- **Incremental command**

In coordinate system rotation mode, G codes related to reference position return (G27, G28, G29, G30, etc.) and those for changing the coordinate system (G52 to G59, G92, etc.) must not be specified. If any of these G codes is necessary, specify it only after canceling coordinate system rotation mode.

The first move command after the coordinate system rotation cancel command (G69) must be specified with absolute values. If an incremental move command is specified, correct movement will not be performed.

Explanations

Absolute/Incremental position commands

```

N1 G92 X-5000 Y-5000 G69 G17 ;
N2 G68 X7000 Y3000 R60000 ;
N3 G90 G01 X0 Y0 F200 ;
  (G91X5000Y5000)
N4 G91 X10000 ;
N5 G02 Y10000 R10000 ;
N6 G03 X-10000 I-5000 J-5000 ;
N7 G01 Y-10000 ;
N8 G69 G90 X-5000 Y-5000 M02 ;

```

Tool path when the incremental command is designated in the N3 block (in parenthesis)

Originally programmed tool path

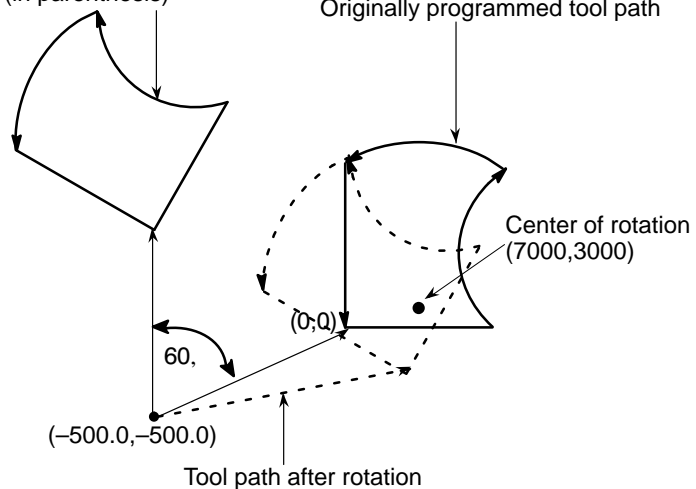


Fig14.10 (c) Absolute/incremental command during coordinate system rotation

Examples

- **Cutter compensation C and coordinate system rotation**

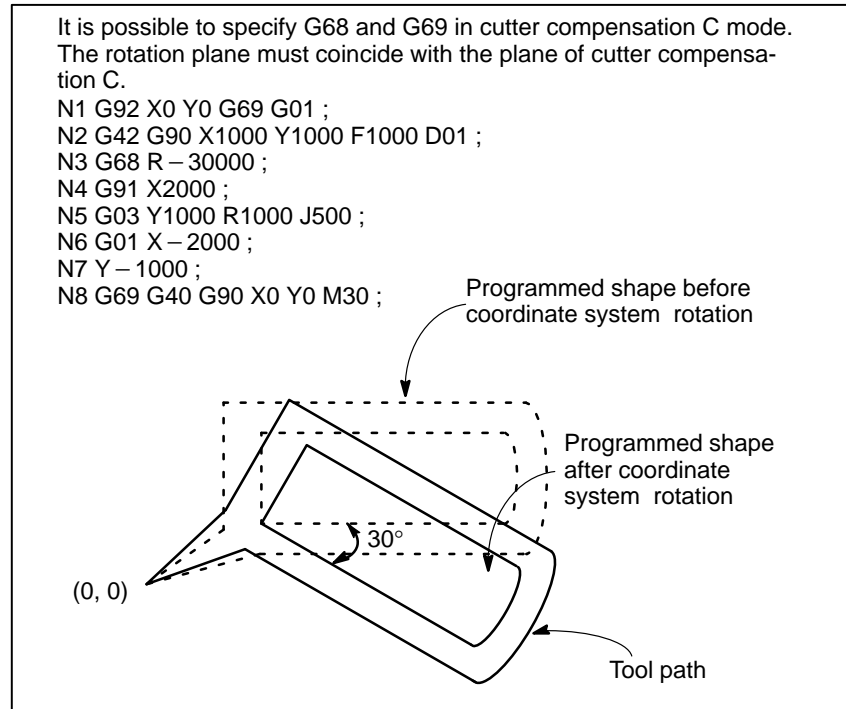


Fig14.10 (d) Cutter compensation C and coordinate system rotation

- **Scaling and coordinate system rotation**

If a coordinate system rotation command is executed in the scaling mode (G51 mode), the coordinate value (α, β) of the rotation center will also be scaled, but not the rotation angle (R). When a move command is issued, the scaling is applied first and then the coordinates are rotated.

A coordinate system rotation command (G68) should not be issued in cutter compensation C mode (G41, G42) on scaling mode (G51). The coordinate system rotation command should always be specified prior to setting the cutter compensation C mode.

1. When the system is not in cutter compensation mode C, specify the commands in the following order :

G51 ; scaling mode start

G68 ; coordinate system rotation mode start

⋮

G69 ; coordinate system rotation mode cancel

G50 ; scaling mode cancel

2. When the system is in cutter compensation model C, specify the commands in the following order (Fig.14.10(e)) :

(cutter compensation C cancel)

G51 ; scaling mode start

G68 ; coordinate system rotation start

:

G41 ;cutter compensation C mode start

:

G92 X0 Y0 ;

G51 X300.0 Y150.0 P500 ;

G68 X200.0 Y100.0 R45.0 ;

G01 X400.0 Y100.0 ;

Y100.0 ;

X-200.0 ;

Y-100.0 ;

X200.0 ;

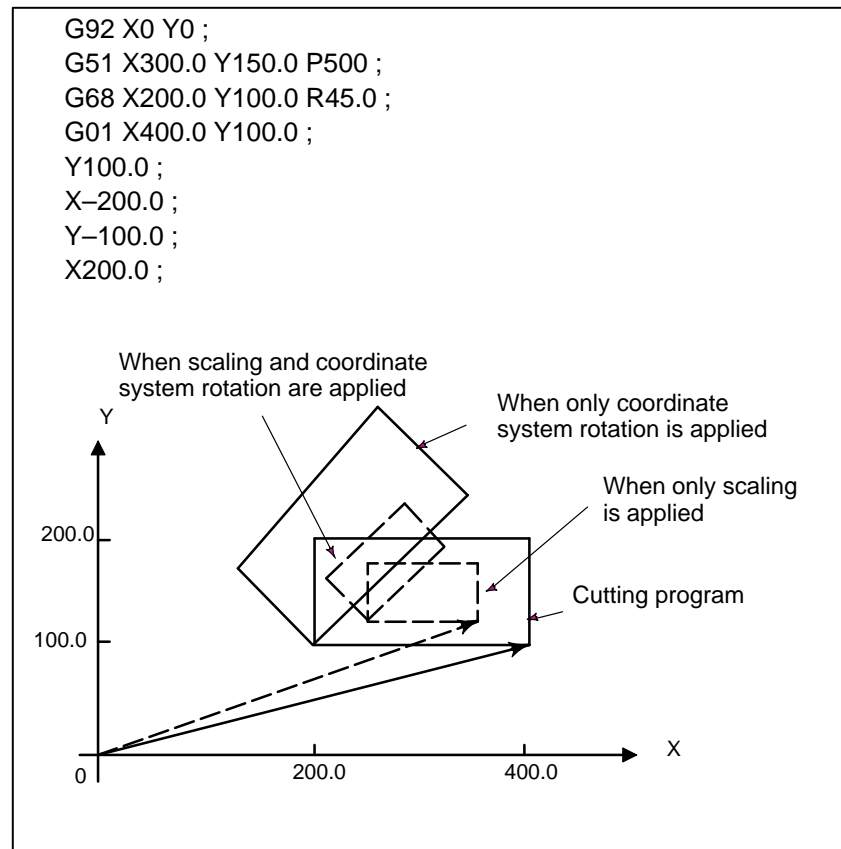


Fig14.10 (e) Scaling and coordinate system rotation in cutter compensation C mode

- **Repetitive commands for coordinate system rotation**

It is possible to store one program as a subprogram and recall subprogram by changing the angle.

Sample program for when the RIN bit (bit 0 of parameter 5400) is set to 1.

The specified angular displacement is treated as an absolute or incremental value depending on the specified G code (G90 or G91).

```
G92 X0 Y0 G69 G17;
G01 F200 H01 ;
M98 P2100 ;
M98 P072200 ;
G00 G90 X0 Y0 M30 ;
```

```
O 2200 G68 X0 Y0 G91 R45.0 ;
G90 M98 P2100 ;
M99 ;
```

```
O 2100 G90 G01 G42 X0 Y-10.0 ;
X4.142 ;
X7.071 Y-7.071 ;
G40 ;
M99 ;
```

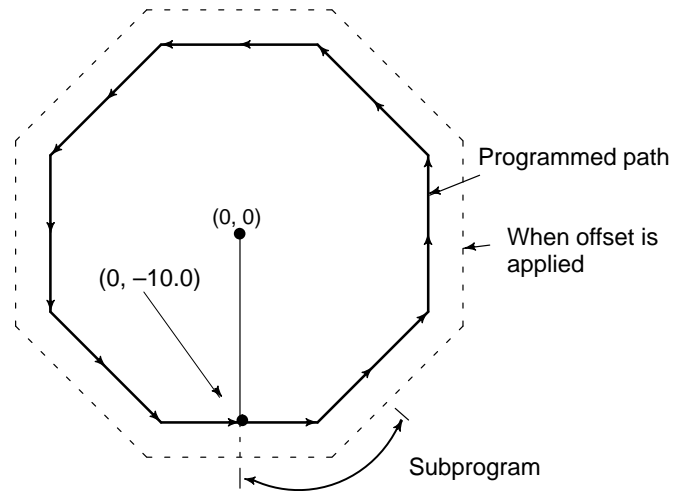


Fig14.10 (f) Coordinate system rotation command

14.11 NORMAL DIRECTION CONTROL (G40.1, G41.1, G42.1 OR G150, G151, G152)

When a tool with a rotation axis (C-axis) is moved in the XY plane during cutting, the normal direction control function can control the tool so that the C-axis is always perpendicular to the tool path (Fig. 14.11 (a)).

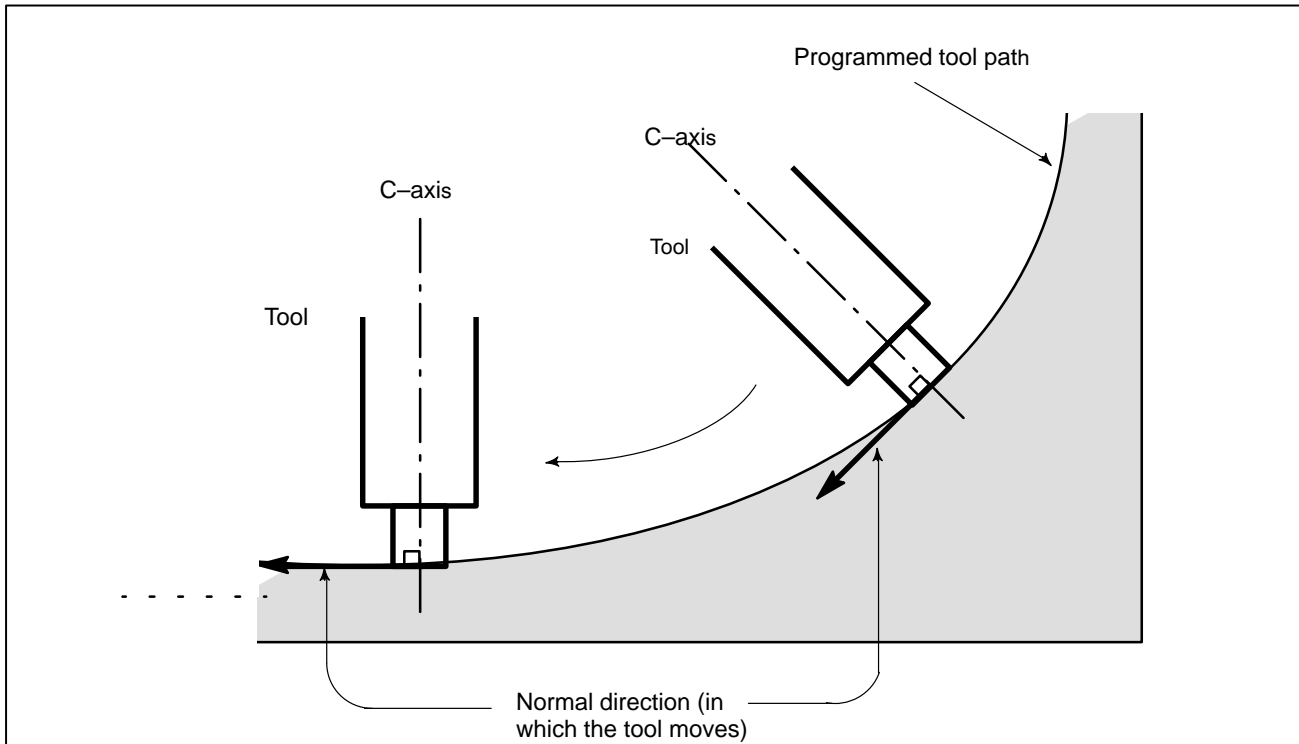


Fig14.11 (a) Sample Movement of the tool

Format

G code	Function	Explanation
G41.1 or G151	Normal direction control left	If the workpiece is to the right of the tool path looking toward the direction in which the tool advances, the normal direction control left (G41.1 or G151) function is specified.
G42.1 or G152	Normal direction control right	After G41.1 (or G151) or G42.1 (or G152) is specified, the normal direction control function is enabled (normal direction control mode).
G40.1 or G150	Normal direction control cancel	When G40.1 (or G150) is specified, the normal direction control mode is canceled.

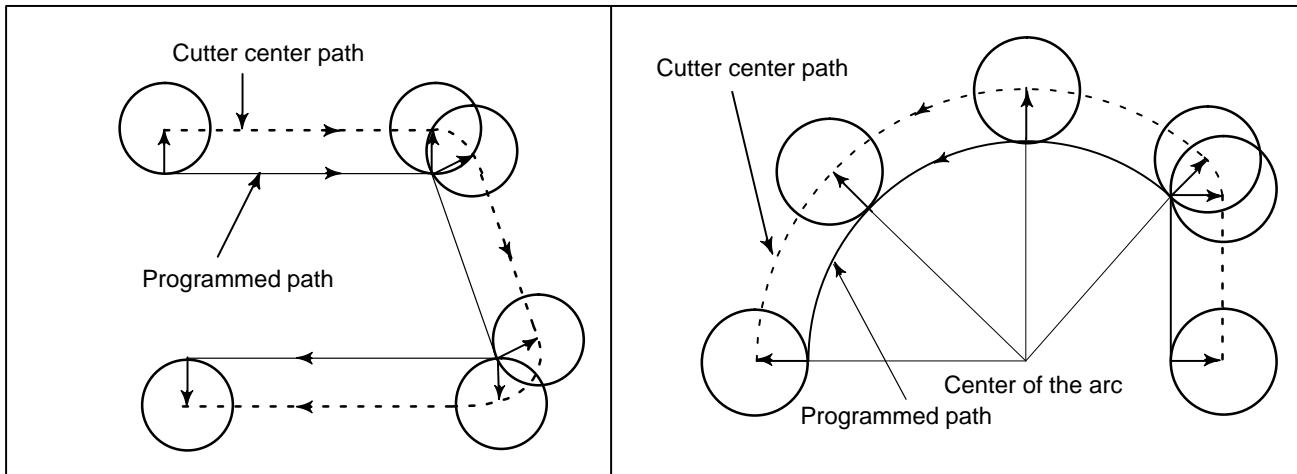


Fig14.11 (b) Normal direction control left (G41.1)

Fig14.11 (c) Normal direction control right (G42.1)

Explanations

• Angle of the C axis

When viewed from the center of rotation around the C-axis, the angular displacement about the C-axis is determined as shown in Fig. 14.11 (d). The positive side of the X-axis is assumed to be 0°, the positive side of the Y-axis is 90°, the negative side of the X-axis is 180°, and the negative side of the Y-axis is 270°.

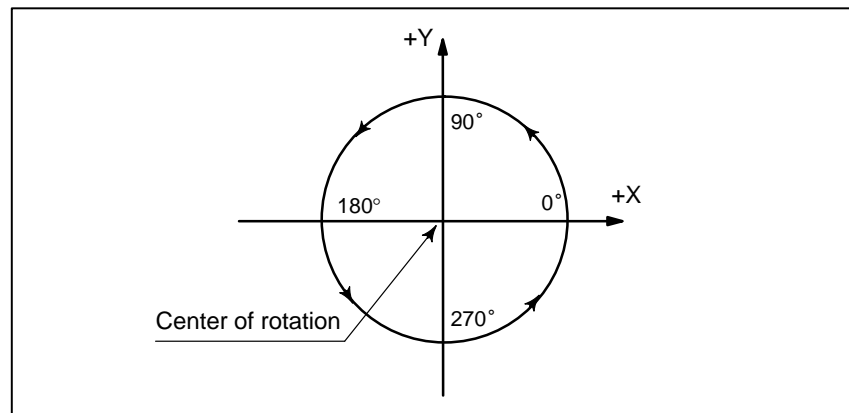


Fig14.11 (d) Angle of the C axis

• Normal direction control of the C axis

When the cancel mode is switched to the normal direction control mode, the C-axis becomes perpendicular to the tool path at the beginning of the block containing G41.1 or G42.1.

In the interface between blocks in the normal direction control mode, a command to move the tool is automatically inserted so that the C-axis becomes perpendicular to the tool path at the beginning of each block. The tool is first oriented so that the C-axis becomes perpendicular to the tool path specified by the move command, then it is moved along the X- and Y axes.

In the cutter compensation mode, the tool is oriented so that the C-axis becomes perpendicular to the tool path created after compensation.

In single-block operation, the tool is not stopped between a command for rotation of the tool and a command for movement along the X- and Y-axes. A single-block stop always occurs after the tool is moved along the X- and Y-axes.

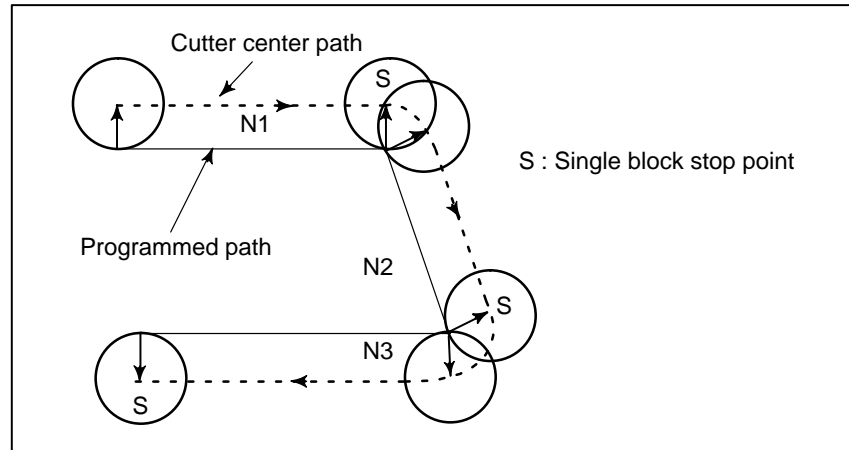


Fig14.11 (e) Point at which a Single-Block Stop Occurs in the Normal Direction Control Mode

Before circular interpolation is started, the C-axis is rotated so that the C-axis becomes normal to the arc at the start point. During circular interpolation, the tool is controlled so that the C-axis is always perpendicular to the tool path determined by circular interpolation.

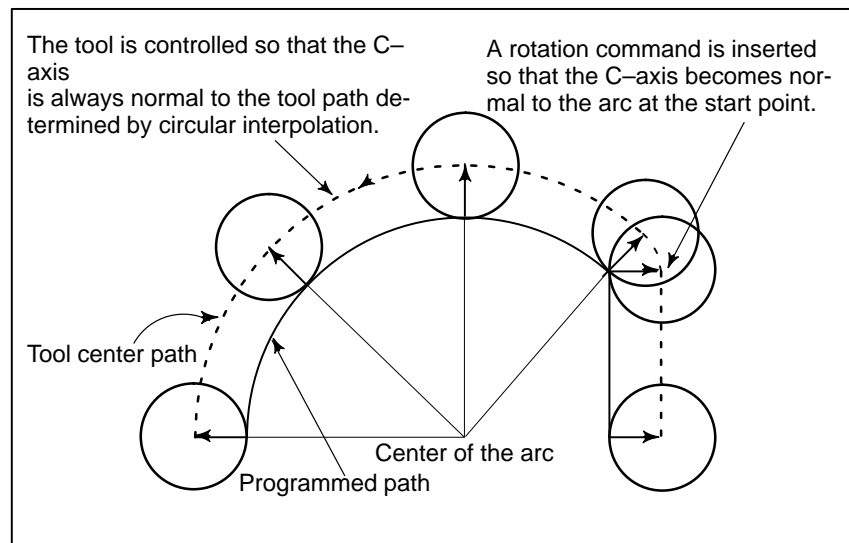


Fig14.11 (f) Normal direction control of the circular interpolation

NOTE

During normal direction control, the C axis always rotates through an angle less than 180 deg. I.e., it rotates in whichever direction provides the shorter route.

- **C axis feedrate**

Movement of the tool inserted at the beginning of each block is executed at the feedrate set in parameter 5481. If dry run mode is on at that time, the dry run feedrate is applied. If the tool is to be moved along the X- and Y-axes in rapid traverse (G00) mode, the rapid traverse feedrate is applied.

The feedrate of the C axis during circular interpolation is defined by the following formula.

$$F \times \frac{\text{Amount of movement of the C axis (deg)}}{\text{Length of arc (mm or inch)}} \text{ (deg/min)}$$

F : Feedrate (mm/min or inch/min) specified by the corresponding block of the arc

Amount of movement of the C axis : The difference in angles at the beginning and the end of the block.

NOTE

If the feedrate of the C axis exceeds the maximum cutting speed of the C axis specified to parameter No. 1422, the feedrate of each of the other axes is clamped to keep the feedrate of the C axis below the maximum cutting speed of the C axis.

- **Normal direction control axis**

A C-axis to which normal-direction control is applied can be assigned to any axis with parameter No. 5480.

- **Angle for which figure insertion is ignored**

When the rotation angle to be inserted, calculated by normal-direction control, is smaller than the value set with parameter No. 5482, the corresponding rotation block is not inserted for the axis to which normal-direction control is applied. This ignored rotation angle is added to the next rotation angle to be inserted, the total angle being subject to the same check at the next block.

If an angle of 360 degrees or more is specified, the corresponding rotation block is not inserted.

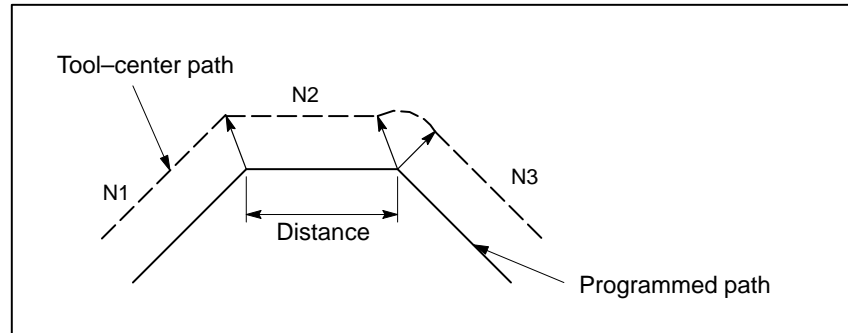
If an angle of 180 degrees or more is specified in a block other than that for circular interpolation with a C-axis rotation angle of 180 degrees or more, the corresponding rotation block is not inserted.

- **Movement for which arc insertion is ignored**

Specify the maximum distance for which machining is performed with the same normal direction as that of the preceding block.

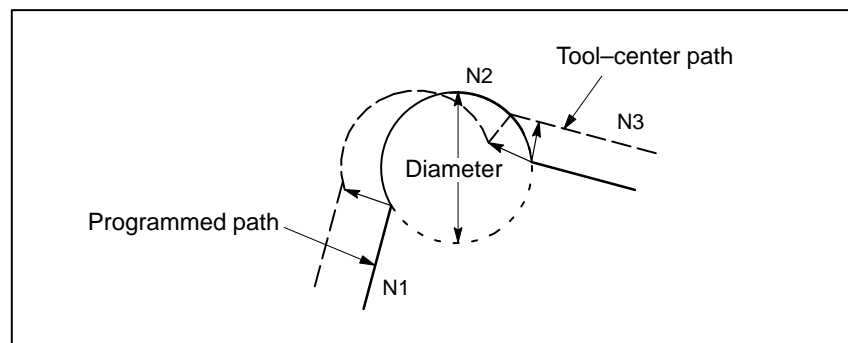
- **Linear movement**

When distance N2, shown below, is smaller than the set value, machining for block N2 is performed using the same direction as that for block N1.



- **Circular movement**

When the diameter of block N2, shown below, is smaller than the set value, machining for block N2 is performed using the same normal direction as that for block N1. The orientation of the axis to which normal-direction control is applied, relative to the normal direction of block N2, does not change as machining proceeds along the arc.



NOTE

- 1 Do not specify any command to the C axis during normal direction control. Any command specified at this time is ignored.
- 2 Before processing starts, it is necessary to correlate the workpiece coordinate of the C axis with the actual position of the C axis on the machine using the coordinate system setting (G92) or the like.
- 3 The helical cutting option is required to use this function. Helical cutting cannot be specified in the normal direction control mode.
- 4 Normal direction control cannot be performed by the G53 move command.
- 5 The C-axis must be a rotation axis.

14.12 PROGRAMMABLE MIRROR IMAGE (G50.1, G51.1)

A mirror image of a programmed command can be produced with respect to a programmed axis of symmetry (Fig. 14.12 (a)).

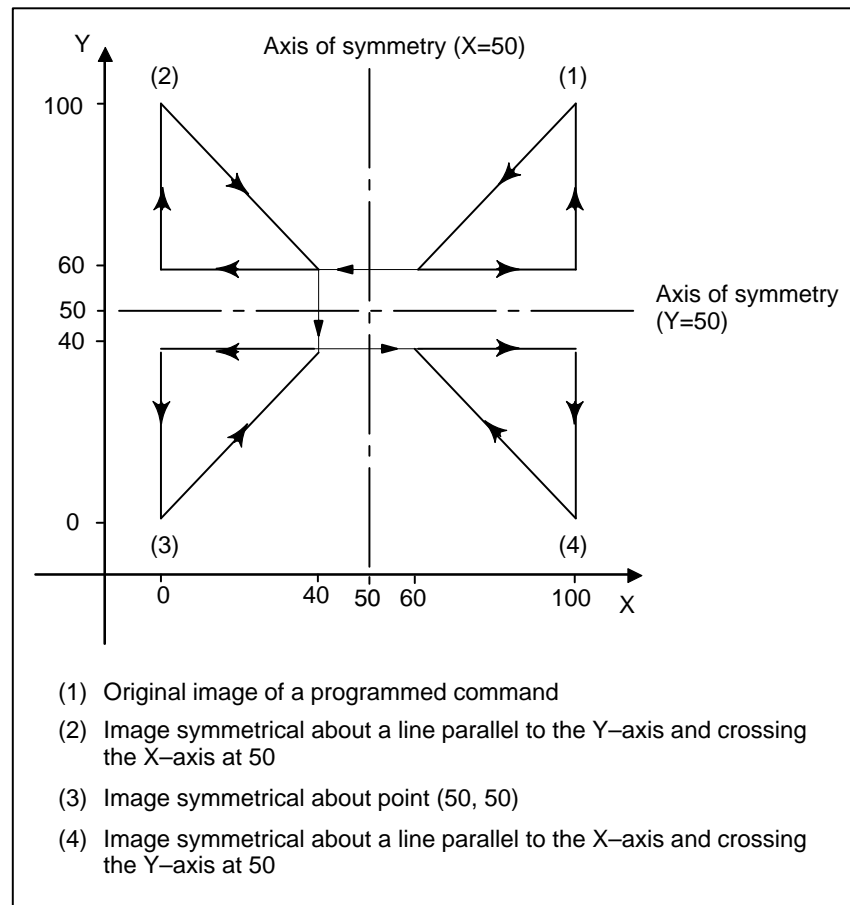


Fig14.12 (a) Programmable Mirror image

Format

G51.1 IP_ ; Setting a programmable image

.....
 }

 }

A mirror image of a command specified in these blocks is produced with respect to the axis of symmetry specified by G51.1IP _;.

G50.1 IP_ ; Canceling a programmable mirror image

IP_ : Point (position) and axis of symmetry for producing a mirror image when specified with G51.1.
 Axis of symmetry for producing a mirror image when specified with G50.1. Point of symmetry is not specified.

Explanations

- **Mirror image by setting**

If the programmable mirror image function is specified when the command for producing a mirror image is also selected by a CNC external switch or CNC setting (see III-4.7), the programmable mirror image function is executed first.

- **Mirror image on a single axis in a specified plane**

Applying a mirror image to one of the axes on a specified plane changes the following commands as follows :

Command	Explanation
Circular command	G02 and G03 are interchanged.
Cutter compensation	G41 and G42 are interchanged.
Coordinate rotation	CW and CCW (directions of rotation) are interchanged.

Limitations

- **Scaling/coordinate system rotation**

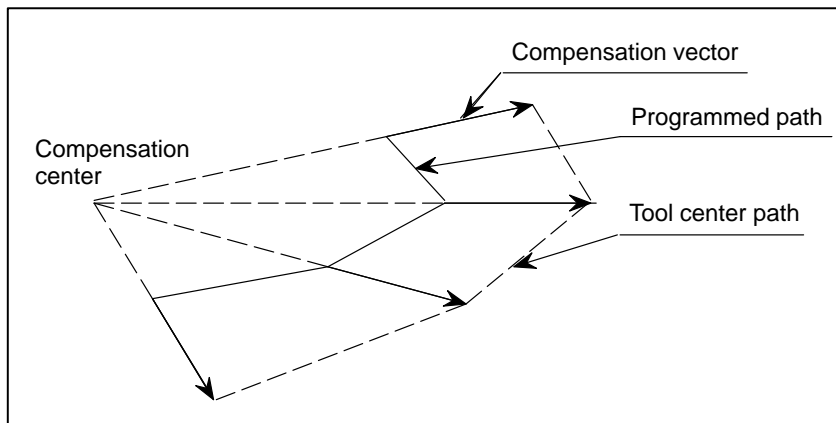
Processing proceeds from program mirror image to scaling and coordinate rotation in the stated order. The commands should be specified in this order, and, for cancellation, in the reverse order. Do not specify G50.1 or G51.1 during scaling or coordinate rotation mode.

- **Commands related to reference position return and coordinate system**

In programmable mirror image mode, G codes related to reference position return (G27, G28, G29, G30, etc.) and those for changing the coordinate system (G52 to G59, G92, etc.) must not be specified. If any of these G codes is necessary, specify it only after canceling the programmable mirror image mode.

14.13 GRINDING WHEEL WEAR COMPENSATION

The grinding wheel compensation function creates a compensation vector by extending the line between the specified compensation center and the specified end point, on the specified compensation plane.



Format

- **Selecting the compensation center**

G41 Pn (n=1, 2, 3);	
G41 P1;	Select the first compensation center
G41 P2;	Select the second compensation center
G41 P3;	Select the third compensation center
D_;	D code other than D0
D0;	
G40;	

- **Start-up**
- **Canceling compensation mode**
- **Holding the compensation vector**

Explanations

- **Setting and selecting the compensation center**

Three compensation centers can be specified by specifying their center coordinates with parameters No. 5081 to 5086. The G41Pn (n = 1, 2, or 3) command is used to specify which compensation center is to be used.

- G41 P1 ; Select the first compensation center.
- G41 P2 ; Select the second compensation center.
- G41 P3 ; Select the third compensation center.

When selecting the compensation center, specify P1, P2, or P3 at the same time with G41. If G41 has been specified without a P command or with a P command other than P1, P2, and P3, P/S alarm 5069 is issued.

When specifying the compensation center with parameters, use the workpiece coordinates.

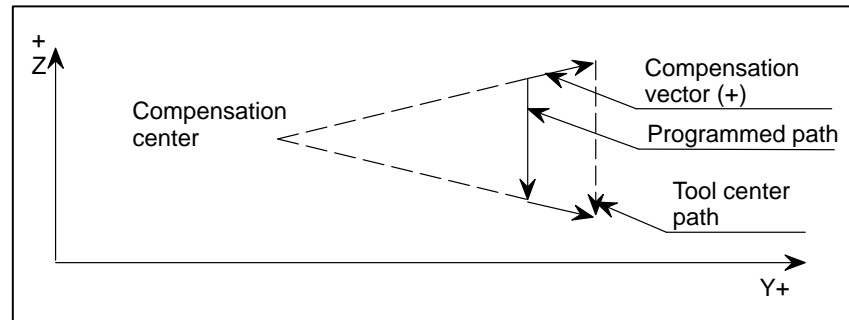
- **Start-up**

To enter compensation mode, specify the compensation center, then specify a D code other than D0. A compensation vector is created and the tool is accordingly moved, even if the block in which the D code has been specified does not contain a move command.

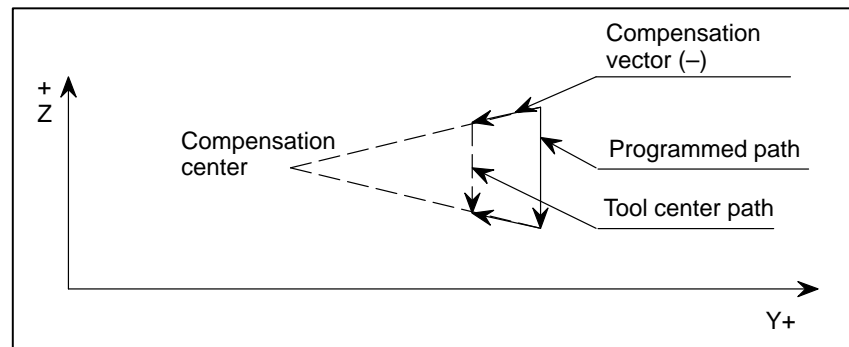
- **Compensation vector**

A compensation vector is created by extending the line between the compensation center and the specified end point. The length of the compensation vector equals to the offset value corresponding to the offset number specified with the D code.

When the offset value is positive, the compensation vector is added to the specified end point. When the offset value is negative, the compensation vector is subtracted from the specified end point.



Offset value (+)



Offset value (-)

- **Canceling compensation mode**
- **Holding the compensation vector**

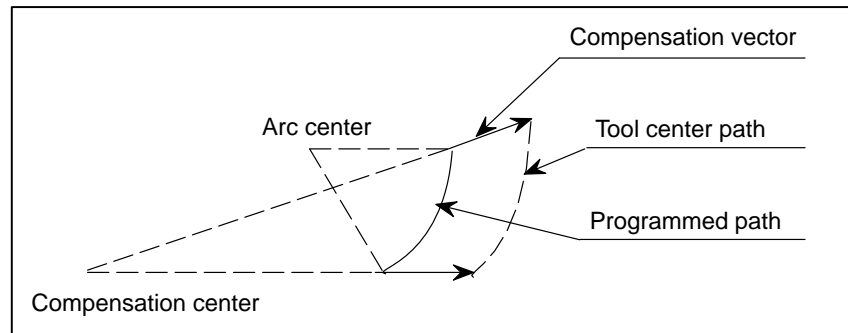
Specifying D0 cancels compensation mode, thus disabling the creation of a compensation vector.

Specifying G40 selects a mode for holding the current compensation vector. In this mode, the specified end point is shifted by the same vector length until a different compensation mode is specified.

Specifying D0 in compensation vector hold mode clears the compensation vector and cancels compensation mode.

- **Circular and helical interpolation**

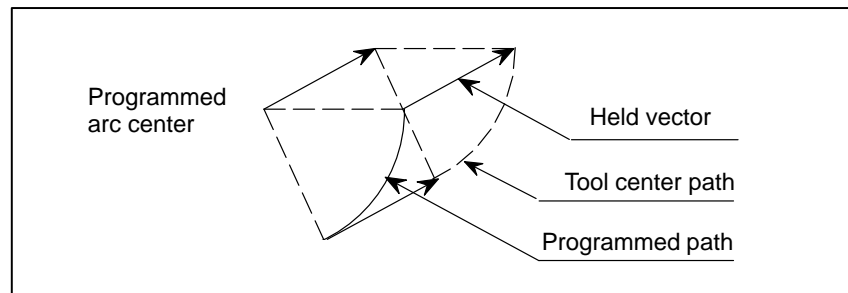
Grinding wheel wear compensation can also be applied to circular interpolation and helical interpolation. If the radius at the start point differs from that at the end point, the figure does not become an arc; it becomes a helix.



The compensated values are still subject to arc radius error limit (parameter No. 3410) check.

- **Circular interpolation in G40 mode**

Specifying an arc command in G40 mode causes the arc center to be shifted by the vector length, thus causing the figure to become an arc, not a helix.



- **Exponential interpolation**

Grinding wheel wear compensation can also be applied to exponential interpolation. Exponential interpolation is performed for the compensated positions.

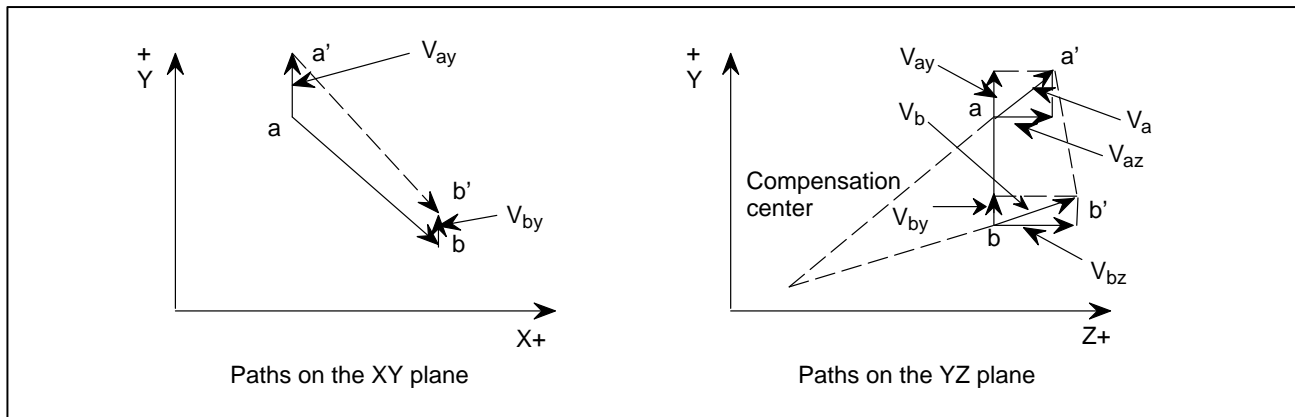
- **Compensation plane and plane selection using G17/G18/G19**

A compensation vector is created only on the plane (compensation plane) corresponding to the axes specified with parameters No. 5071 and 5072 (compensation axes).

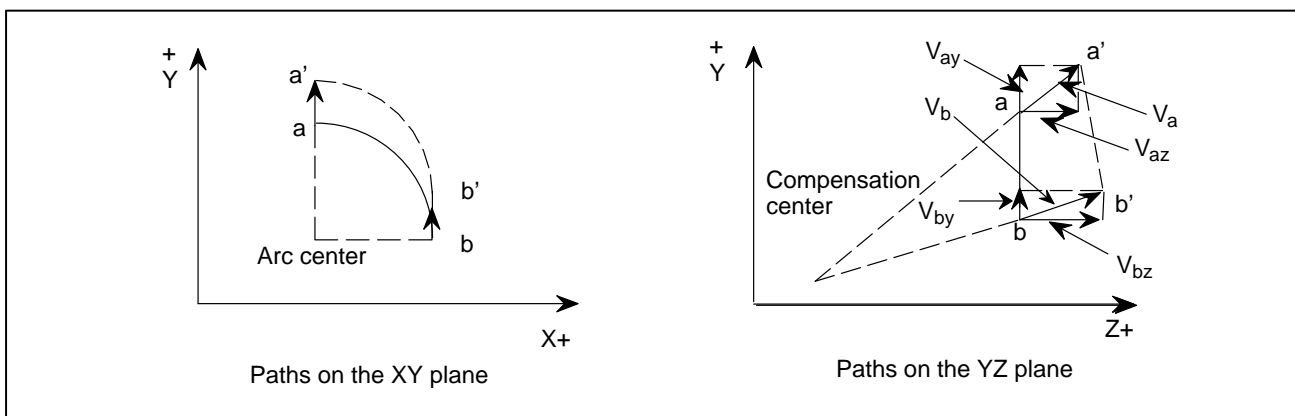
In compensation mode (including compensation vector hold mode), a compensation vector is always created on the compensation plane specified with parameters (No. 5071 and 5072), regardless of the plane selected with the G17, G18, or G19 command. For example, compensation can be performed using the YZ plane as the compensation plane while circular interpolation is performed on the XY plane (G17).

If a move command has been specified for either compensation axis, in compensation mode, the compensation vector component of the other axis may be changed during compensation vector creation, thus causing the tool to also move along that axis.

(Example 1) When the compensation axes are the Y- and Z-axes and linear interpolation is performed for the X- and Y-axes
 Programmed path: $a \rightarrow b$, compensated path: $a' \rightarrow b'$



(Example 2) When the compensation axes are the Y- and Z-axes and circular interpolation is performed for the X- and Y-axes
 Programmed path: $a \rightarrow b$, compensated path: $a' \rightarrow b'$



- **Compensation cancel mode**

Compensation cancel mode is selected immediately after power-on or reset.

- **Changing the coordinate system**

Before attempting to change the coordinate system, cancel compensation mode.

- **Reference position return (G28, G30)**

Before attempting to return to the reference point (G28 or G30), cancel compensation mode.

Limitations

- **Changing the compensation axes**

The compensation axes can be changed only in compensation cancel mode.

- **Relationship with other offset functions**

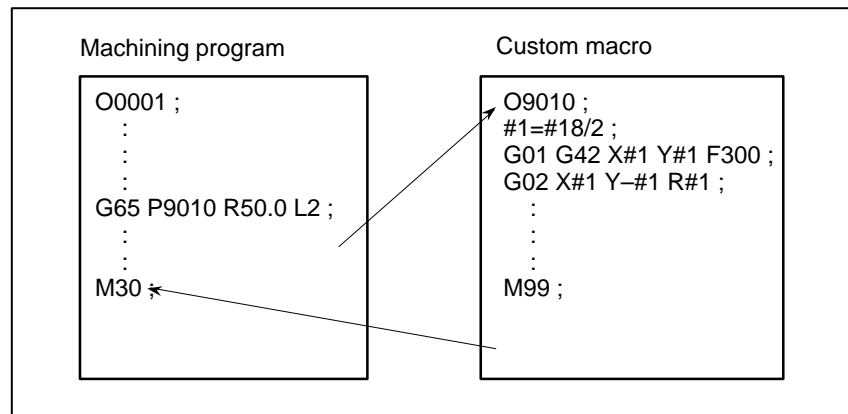
Cutter compensation and three-dimensional tool compensation cannot be used when grinding wheel wear compensation is enabled on the system. The tool length offset and tool position offset functions can be used with grinding wheel wear compensation.

- **Relationship with the coordinate change function**

The coordinates of the compensation center are not subject to programmable mirror image, scaling, or coordinate rotation.

15 CUSTOM MACRO

Although subprograms are useful for repeating the same operation, the custom macro function also allows use of variables, arithmetic and logic operations, and conditional branches for easy development of general programs such as pocketing and user-defined canned cycles. A machining program can call a custom macro with a simple command, just like a subprogram.



15.1 VARIABLES

An ordinary machining program specifies a G code and the travel distance directly with a numeric value; examples are G100 and X100.0.

With a custom macro, numeric values can be specified directly or using a variable number. When a variable number is used, the variable value can be changed by a program or using operations on the MDI panel.

```
#1=#2+100 ;
G01 X#1 F300 ;
```

Explanation

- **Variable representation**

When specifying a variable, specify a number sign (#) followed by a variable number. General-purpose programming languages allow a name to be assigned to a variable, but this capability is not available for custom macros.

Example: #1

An expression can be used to specify a variable number. In such a case, the expression must be enclosed in brackets.

Example: #[#1+#2-12]

- **Types of variables**

Variables are classified into four types by variable number.

Table 15.1 Types of variables

Variable number	Type of variable	Function
#0	Always null	This variable is always null. No value can be assigned to this variable.
#1 – #33	Local variables	Local variables can only be used within a macro to hold data such as the results of operations. When the power is turned off, local variables are initialized to null. When a macro is called, arguments are assigned to local variables.
#100 – #149 (#199) #500 – #531 (#999)	Common variables	Common variables can be shared among different macro programs. When the power is turned off, variables #100 to #149 are initialized to null. Variables #500 to #531 hold data even when the power is turned off. As an option, common variables #150 to #199 and #532 to #999 are also available. However, when these values are using.
#1000 –	System variables	System variables are used to read and write a variety of NC data items such as the current position and tool compensation values.

NOTE

Common variables #150 to #199 and #532 to #999 are optional.

- **Range of variable values**

Local and common variables can have value 0 or a value in the following ranges :

-10^{47} to -10^{-29}
 10^{-29} to 10^{47}

If the result of calculation turns out to be invalid, an P/S alarm No. 111 is issued.
- **Omission of the decimal point**

When a variable value is defined in a program, the decimal point can be omitted.

Example:
 When #1=123; is defined, the actual value of variable #1 is 123.000.
- **Referencing variables**

To reference the value of a variable in a program, specify a word address followed by the variable number. When an expression is used to specify a variable, enclose the expression in brackets.

Example: G01X[#1+#2]F#3;

A referenced variable value is automatically rounded according to the least input increment of the address.

Example:
 When G00X#1; is executed on a 1/1000–mm CNC with 12.3456 assigned to variable #1, the actual command is interpreted as G00X12.346;.

To reverse the sign of a referenced variable value, prefix a minus sign (–) to #.

Example: G00X–#1;

When an undefined variable is referenced, the variable is ignored up to an address word.

Example:
 When the value of variable #1 is 0, and the value of variable #2 is null, execution of G00X#1Y#2; results in G00X0;.
- **Common custom macro variables for tow paths (two–path control)**

For two–path control, macro variables are provided for each path. Some common variables, however, can be used for both paths, by setting parameters No. 6036 and 6037 accordingly.
- **Undefined variable**

When the value of a variable is not defined, such a variable is referred to as a “null” variable. Variable #0 is always a null variable. It cannot be written to, but it can be read.

(a) Quotation
 When an undefined variable is quoted, the address itself is also ignored.

[Example] When #1 is 0 and #2 is null, the result of executing G00 X#1 Y#2; will be the same as when G00 X0; is executed.

(b) Operation

< vacant > is the same as 0 except when replaced by < vacant >

When #1 = < vacant >	When #1 = 0
#2 = #1 ↓ #2 = < vacant >	#2 = #1 ↓ #2 = 0
#2 = #1*5 ↓ #2 = 0	#2 = #1*5 ↓ #2 = 0
#2 = #1+#1 ↓ #2 = 0	#2 = #1 + #1 ↓ #2 = 0

(c) Conditional expressions

< vacant > differs from 0 only for EQ and NE.

When #1 = < vacant >	When #1 = 0
#1 EQ #0 ↓ Established	#1 EQ #0 ↓ Not established
#1 NE 0 ↓ Established	#1 NE 0 ↓ Not established
#1 GE #0 ↓ Established	#1 GE #0 ↓ Established
#1 GT 0 ↓ Not established	#1 GT 0 ↓ Not established

```

VARIABLE                                O1234 N12345
NO.      DATA      NO.      DATA
100      123.456    108
101      0.000      109
102
103
104
105
106
107
115

ACTUAL POSITION (RELATIVE)
X      0.000      Y      0.000
Z      0.000      B      0.000

MEM **** * * * * *      18:42:15
[ MACRO ] [ MENU ] [ OPR ] [ ] [ (OPRT) ]
    
```

- When the value of a variable is blank, the variable is null.
- The mark ***** indicates an overflow (when the absolute value of a variable is greater than 99999999) or an underflow (when the absolute value of a variable is less than 0.0000001).

Limitations

Program numbers, sequence numbers, and optional block skip numbers cannot be referenced using variables.

Example:

Variables cannot be used in the following ways:

O#1;

/#2G00X100.0;

N#3Y200.0;

15.2 SYSTEM VARIABLES

System variables can be used to read and write internal NC data such as tool compensation values and current position data. Note, however, that some system variables can only be read. System variables are essential for automation and general-purpose program development.

Explanations

- **Interface signals**

Signals can be exchanged between the programmable machine controller (PMC) and custom macros.

Table 15.2(a) System variables for interface signals

Variable number	Function
#1000–#1015 #1032	A 16-bit signal can be sent from the PMC to a custom macro. Variables #1000 to #1015 are used to read a signal bit by bit. Variable #1032 is used to read all 16 bits of a signal at one time.
#1100–#1115 #1132	A 16-bit signal can be sent from a custom macro to the PMC. Variables #1100 to #1115 are used to write a signal bit by bit. Variable #1132 is used to write all 16 bits of a signal at one time.
#1133	Variable #1133 is used to write all 32 bits of a signal at one time from a custom macro to the PMC. Note, that values from –99999999 to +99999999 can be used for #1133.

For detailed information, refer to the connection manual (B-63003EN-1).

- **Tool compensation values**

Tool compensation values can be read and written using system variables. Usable variable numbers depend on the number of compensation pairs, whether a distinction is made between geometric compensation and wear compensation, and whether a distinction is made between tool length compensation and cutter compensation. When the number of compensation pairs is not greater than 200, variables #2001 to #2400 can also be used.

Table 15.2(b) System variables for tool compensation memory A

Compensation number	System variable
1	#10001 (#2001)
:	:
200	#10200 (#2200)
:	:
999	#10999

Table 15.2(c) System variables for tool compensation memory B

Compensation number	Geometry compensation	Wear compensation
1	#11001 (#2201)	#10001 (#2001)
:	:	:
200	#11200 (#2400)	#10200 (#2200)
:	:	:
999	#11999	#10999

Table 15.2(d) System variables for tool compensation memory C

Compensation number	Tool length compensation (H)		Cutter compensation (D)	
	Geometric compensation	Wear compensation	Geometric compensation	Wear compensation
1	#11001(#2201)	#10001(#2001)	#13001	#12001
:	:	:	:	:
200	#11201(#2400)	#10201(#2200)	:	:
:	:	:	:	:
999	#11999	#10999	#13999	#12999

- Macro alarms

Table 15.2(e) System variable for macro alarms

Variable number	Function
#3000	When a value from 0 to 200 is assigned to variable #3000, the CNC stops with an alarm. After an expression, an alarm message not longer than 26 characters can be described. The CRT screen displays alarm numbers by adding 3000 to the value in variable #3000 along with an alarm message.

Example:

```
#3000=1(TOOL NOT FOUND);
```

→ The alarm screen displays "3001 TOOL NOT FOUND."

- Time information

Time information can be read and written.

Table 15.2(f) System variables for time information

Variable number	Function
#3001	This variable functions as a timer that counts in 1-millisecond increments at all times. When the power is turned on, the value of this variable is reset to 0. When 2147483648 milliseconds is reached, the value of this timer returns to 0.
#3002	This variable functions as a timer that counts in 1-hour increments when the cycle start lamp is on. This timer preserves its value even when the power is turned off. When 9544.371767 hours is reached, the value of this timer returns to 0.
#3011	This variable can be used to read the current date (year/month/day). Year/month/day information is converted to an apparent decimal number. For example, September 28, 1994 is represented as 19940928.
#3012	This variable can be used to read the current time (hours/minutes/seconds). Hours/minutes/seconds information is converted to an apparent decimal number. For example, 34 minutes and 56 seconds after 3 p.m. is represented as 153456.

- **Automatic operation control**

The control state of automatic operation can be changed.

Table 15.2(g) System variable (#3003) for automatic operation control

#3003	Single block	Completion of an auxiliary function
0	Enabled	To be awaited
1	Disabled	To be awaited
2	Enabled	Not to be awaited
3	Disabled	Not to be awaited

- When the power is turned on, the value of this variable is 0.
- When single block stop is disabled, single block stop operation is not performed even if the single block switch is set to ON.
- When a wait for the completion of auxiliary functions (M, S, and T functions) is not specified, program execution proceeds to the next block before completion of auxiliary functions. Also, distribution completion signal DEN is not output.

Table 15.2(h) System variable (#3004) for automatic operation control

#3004	Feed hold	Feedrate Override	Exact stop
0	Enabled	Enabled	Enabled
1	Disabled	Enabled	Enabled
2	Enabled	Disabled	Enabled
3	Disabled	Disabled	Enabled
4	Enabled	Enabled	Disabled
5	Disabled	Enabled	Disabled
6	Enabled	Disabled	Disabled
7	Disabled	Disabled	Disabled

- When the power is turned on, the value of this variable is 0.
- When feed hold is disabled:
 - (1) When the feed hold button is held down, the machine stops in the single block stop mode. However, single block stop operation is not performed when the single block mode is disabled with variable #3003.
 - (2) When the feed hold button is pressed then released, the feed hold lamp comes on, but the machine does not stop; program execution continues and the machine stops at the first block where feed hold is enabled.
- When feedrate override is disabled, an override of 100% is always applied regardless of the setting of the feedrate override switch on the machine operator's panel.

- When exact stop check is disabled, no exact stop check (position check) is made even in blocks including those which do not perform cutting.

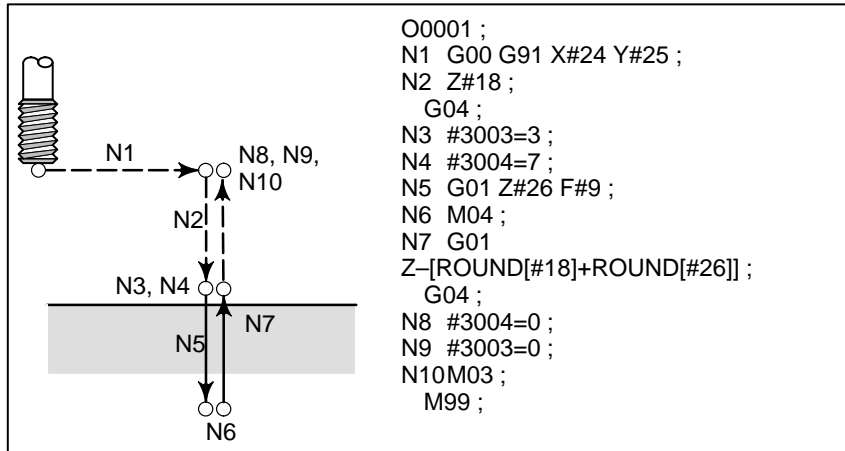


Fig. 15.2(a) Example of using variable #3004 in a tapping cycle

• **Settings**

Settings can be read and written. Binary values are converted to decimals.

#3005							
Setting	#15	#14	#13	#12	#11	#10	#9
							FCV
Setting	#7	#6	#5	#4	#3	#2	#1
			SEQ			INI	ISO
							TVC

#9 (FCV) : Whether to use the FS15 tape format conversion capability
 #5 (SEQ) : Whether to automatically insert sequence numbers
 #2 (INI) : Millimeter input or inch input
 #1 (ISO) : Whether to use EIA or ISO as the output code
 #0 (TVC) : Whether to make a TV check

• **Mirror image**

The mirror-image status for each axis set using an external switch or setting operation can be read through the output signal (mirror-image check signal). The mirror-image status present at that time can be checked. (See III-4.7)

The value obtained in binary is converted into decimal notation.

#3007							
Setting	#7	#6	#5	#4	#3	#2	#1
	8th axis	7th axis	6th axis	5th axis	4th axis	3th axis	2th axis
							1th axis

For each bit, $\left[\begin{array}{l} 0 \text{ (mirror-image function is disabled)} \\ \text{or} \\ 1 \text{ (mirror-image function is enabled)} \end{array} \right]$ is indicated.

Example : If #3007 is 3, the mirror-image function is enabled for the first and second axes.

- When the mirror-image function is set for a certain axis by both the mirror-image signal and setting, the signal value and setting value are ORed and then output.

- When mirror-image signals for axes other than the controlled axes are turned on, they are still read into system variable #3007.
- System variable #3007 is a write-protected system variable. If an attempt is made to write data in the variable, P/S 116 alarm “WRITE PROTECTED VARIABLE” is issued.

• Number of machined parts

The number (target number) of parts required and the number (completion number) of machined parts can be read and written.

Table 15.2(i) System variables for the number of parts required and the number of machined parts

Variable number	Function
#3901	Number of machined parts (completion number)
#3902	Number of required parts (target number)

NOTE

Do not substitute a negative value.

• Modal information

Modal information specified in blocks up to the immediately preceding block can be read.

Table 15.2(j) System variables for modal information

Variable number	Function
#4001	G00, G01, G02, G03, G33 (Group 01)
#4002	G17, G18, G19 (Group 02)
#4003	G90, G91 (Group 03)
#4004	(Group 04)
#4005	G94, G95 (Group 05)
#4006	G20, G21 (Group 06)
#4007	G40, G41, G42 (Group 07)
#4008	G43, G44, G49 (Group 08)
#4009	G73, G74, G76, G80–G89 (Group 09)
#4010	G98, G99 (Group 10)
#4011	G50, G51 (Group 11)
#4012	G65, G66, G67 (Group 12)
#4013	G96, G97 (Group 13)
#4014	G54–G59 (Group 14)
#4015	G61–G64 (Group 15)
#4016	G68, G69 (Group 16)
:	:
#4022	(Group 22)
#4102	B code
#4107	D code
#4109	F code
#4111	H code
#4113	M code
#4114	Sequence number
#4115	Program number
#4119	S code
#4120	T code
#4130	P code (number of the currently selected additional workpiece coordinate system)

Example:

When #1=#4001; is executed, the resulting value in #1 is 0, 1, 2, 3, or 33.

If the specified system variable for reading modal information corresponds to a G code group which cannot be used, a P/S alarm is issued.

- **Current position**

Position information cannot be written but can be read.

Table 15.2(k) System variables for position information

Variable number	Position information	Coordinate system	Tool compensation value	Read operation during movement
#5001–#5008	Block end point	Workpiece coordinate system	Not included	Enabled
#5021–#5028	Current position	Machine coordinate system	Included	Disabled
#5041–#5048	Current position	Workpiece coordinate system		
#5061–#5068	Skip signal position			
#5081–#5088	Tool length offset value			Disabled
#5101–#5108	Deviated servo position			

- The first digit (from 1 to 8) represents an axis number.
- The tool length offset value currently used for execution rather than the immediately preceding tool offset value is held in variables #5081 to 5088.
- The tool position where the skip signal is turned on in a G31 (skip function) block is held in variables #5061 to #5068. When the skip signal is not turned on in a G31 block, the end point of the specified block is held in these variables.
- When read during movement is "disabled," this means that expected values cannot be read due to the buffering (pre-read) function.

- **Workpiece coordinate system compensation values (workpiece zero point offset values)**

Workpiece zero point offset values can be read and written.

Table 15.2(I) System variables for workpiece zero point offset values

Variable number	Function
#5201 : #5208	First-axis external workpiece zero point offset value : Eighth-axis external workpiece zero point offset value
#5221 : #5228	First-axis G54 workpiece zero point offset value : Eighth-axis G54 workpiece zero point offset value
#5241 : #5248	First-axis G55 workpiece zero point offset value : Eighth-axis G55 workpiece zero point offset value
#5261 : #5268	First-axis G56 workpiece zero point offset value : Eighth-axis G56 workpiece zero point offset value
#5281 : #5288	First-axis G57 workpiece zero point offset value : Eighth-axis G57 workpiece zero point offset value
#5301 : #5308	First-axis G58 workpiece zero point offset value : Eighth-axis G58 workpiece zero point offset value
#5321 : #5328	First-axis G59 workpiece zero point offset value : Eighth-axis G59 workpiece zero point offset value
#7001 : #7008	First-axis workpiece zero point offset value (G54.1 P1) : Eighth-axis workpiece zero point offset value
#7021 : #7028	First-axis workpiece zero point offset value (G54.1 P2) : Eighth-axis workpiece zero point offset value
: :	: :
#7941 : #7948	First-axis workpiece zero point offset value (G54.1 P48) : Eighth-axis workpiece zero point offset value
#14001 : #14008	First-axis workpiece zero point offset value (G54.1 P1) : Eighth-axis workpiece zero point offset value
#14021 : #14028	First-axis workpiece zero point offset value (G54.1 P2) : Eighth-axis workpiece zero point offset value
: :	: :
#19980 : #19988	First-axis workpiece zero point offset value (G54.1 P300) : Eighth-axis workpiece zero point offset value

The following variables can also be used:

Axis	Function	Variable number	
First axis	External workpiece zero point offset	#2500	#5201
	G54 workpiece zero point offset	#2501	#5221
	G55 workpiece zero point offset	#2502	#5241
	G56 workpiece zero point offset	#2503	#5261
	G57 workpiece zero point offset	#2504	#5281
	G58 workpiece zero point offset	#2505	#5301
	G59 workpiece zero point offset	#2506	#5321
Second axis	External workpiece zero point offset	#2600	#5202
	G54 workpiece zero point offset	#2601	#5222
	G55 workpiece zero point offset	#2602	#5242
	G56 workpiece zero point offset	#2603	#5262
	G57 workpiece zero point offset	#2604	#5282
	G58 workpiece zero point offset	#2605	#5302
	G59 workpiece zero point offset	#2606	#5322
Third axis	External workpiece zero point offset	#2700	#5203
	G54 workpiece zero point offset	#2701	#5223
	G55 workpiece zero point offset	#2702	#5243
	G56 workpiece zero point offset	#2703	#5263
	G57 workpiece zero point offset	#2704	#5283
	G58 workpiece zero point offset	#2705	#5303
	G59 workpiece zero point offset	#2706	#5323
Fourth axis	External workpiece zero point offset	#2800	#5204
	G54 workpiece zero point offset	#2801	#5224
	G55 workpiece zero point offset	#2802	#5244
	G56 workpiece zero point offset	#2803	#5264
	G57 workpiece zero point offset	#2804	#5284
	G58 workpiece zero point offset	#2805	#5304
	G59 workpiece zero point offset	#2806	#5324

NOTE

To use variables #2500 to #2806 and #5201 to #5328, optional variables for the workpiece coordinate systems are necessary.

Optional variables for 48 additional workpiece coordinate systems are #7001 to #7948 (G54.1 P1 to G54.1 P48).

Optional variables for 300 additional workpiece coordinate systems are #14001 to #19988 (G54.1 P1 to G54.1 P300).

With these variables, #7001 to #7948 can also be used.

15.3 ARITHMETIC AND LOGIC OPERATION

The operations listed in Table 15.3(a) can be performed on variables. The expression to the right of the operator can contain constants and/or variables combined by a function or operator. Variables #j and #K in an expression can be replaced with a constant. Variables on the left can also be replaced with an expression.

Table 15.3(a) Arithmetic and logic operation

Function	Format	Remarks
Definition	#i=#j	
Sum Difference Product Quotient	#i=#j+#k; #i=#j-#k; #i=#j*#k; #i=#j/#k;	
Sine Arcsine Tangent Arctangent	#i=SIN[#j]; #i=COS[#j]; #i=TAN[#j]; #i=ATAN[#j]/[#k];	An angle is specified in degrees. 90 degrees and 30 minutes is represented as 90.5 degrees.
Square root Absolute value Rounding off Rounding down Rounding up Natural logarithm Exponential function	#i=SQRT[#j]; #i=ABS[#j]; #i=ROUND[#j]; #i=FIX[#j]; #i=FUP[#j]; #i=LN[#j]; #i=EXP[#j];	
OR XOR AND	#i=#j OR #k; #i=#j XOR #k; #i=#j AND #k;	A logical operation is performed on binary numbers bit by bit.
Conversion from BCD to BIN Conversion from BIN to BCD	#i=BIN[#j]; #i=BCD[#j];	Used for signal exchange to and from the PMC

Explanations

- **Angle units**

The units of angles used with the SIN, COS, ASIN, ACOS, TAN, and ATAN functions are degrees. For example, 90 degrees and 30 minutes is represented as 90.5 degrees.

- **ARCSIN #i = ASIN[#j];**

- The solution ranges are as indicated below:
When the NAT bit (bit 0 of parameter 6004) is set to 0: 270° to 90°
When the NAT bit (bit 0 of parameter 6004) is set to 1: -90° to 90°-

- When #j is beyond the range of -1 to 1, P/S alarm No. 111 is issued.
- A constant can be used instead of the #j variable.

- **ARCCOS #i = ACOS[#j];**

- The solution ranges from 180° to 0°.
- When #j is beyond the range of -1 to 1, P/S alarm No. 111 is issued.
- A constant can be used instead of the #j variable.

- **ARCTAN #i = ATAN[#j]/[#k];**

- Specify the lengths of two sides, separated by a slash (/).
- The solution ranges are as follows:

When the NAT bit (bit 0 of parameter 6004) is set to 0: 0° to 360°

[Example] When #1 = ATAN[-1]/[-1]; is specified, #1 is 225.0.

When the NAT bit (bit 0 of parameter 6004) is set to 1: -180° to 180°

[Example] When #1 = ATAN[-1]/[-1]; is specified, #1 is -135.0.0.

- A constant can be used instead of the #j variable.

- **Natural logarithm #i = LN[#j];**

- Note that the relative error may become 10^{-8} or greater.
- When the antilogarithm (#j) is zero or smaller, P/S alarm No. 111 is issued.
- A constant can be used instead of the #j variable.

- **Exponential function #i = EXP[#j];**

- Note that the relative error may become 10^{-8} or greater.
- When the result of the operation exceeds 3.65×10^{47} (j is about 110), an overflow occurs and P/S alarm No. 111 is issued.
- A constant can be used instead of the #j variable.

- **ROUND function**

- When the ROUND function is included in an arithmetic or logic operation command, IF statement, or WHILE statement, the ROUND function rounds off at the first decimal place.

Example:

When #1=ROUND[#2]; is executed where #2 holds 1.2345, the value of variable #1 is 1.0.

- When the ROUND function is used in NC statement addresses, the ROUND function rounds off the specified value according to the least input increment of the address.

Example:

Creation of a drilling program that cuts according to the values of variables #1 and #2, then returns to the original position

Suppose that the increment system is 1/1000 mm, variable #1 holds 1.2345, and variable #2 holds 2.3456. Then,

G00 G91 X-#1; Moves 1.235 mm.

G01 X-#2 F300; Moves 2.346 mm.

G00 X[#1+#2]; Since $1.2345 + 2.3456 = 3.5801$, the travel distance is 3.580, which does not return the tool to the original position.

This difference comes from whether addition is performed before or after rounding off. G00X-[ROUND[#1]+ROUND[#2]] must be specified to return the tool to the original position.

- **Rounding up and down to an integer**

With CNC, when the absolute value of the integer produced by an operation on a number is greater than the absolute value of the original number, such an operation is referred to as rounding up to an integer. Conversely, when the absolute value of the integer produced by an operation on a number is less than the absolute value of the original number, such an operation is referred to as rounding down to an integer. Be particularly careful when handling negative numbers.

Example:

Suppose that #1=1.2 and #2=-1.2.

When #3=FUP[#1] is executed, 2.0 is assigned to #3.

When #3=FIX[#1] is executed, 1.0 is assigned to #3.

When #3=FUP[#2] is executed, -2.0 is assigned to #3.

When #3=FIX[#2] is executed, -1.0 is assigned to #3.

- **Abbreviations of arithmetic and logic operation commands**

When a function is specified in a program, the first two characters of the function name can be used to specify the function (See III-9.7).

Example:

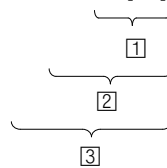
ROUND → RO

FIX → FI

- **Priority of operations**

- ① Functions
- ② Operations such as multiplication and division (*, /, AND)
- ③ Operations such as addition and subtraction (+, -, OR, XOR)

Example) #1=#2+#3*SIN[#4];

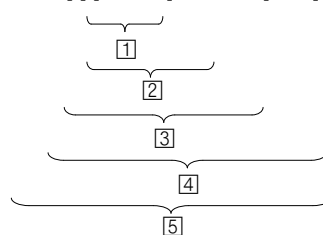


①, ② and ③ indicate the order of operations.

- **Bracket nesting**

Brackets are used to change the order of operations. Brackets can be used to a depth of five levels including the brackets used to enclose a function. When a depth of five levels is exceeded, P/S alarm No. 118 occurs.

Example) #1=SIN [[[#2+#3] *#4 +#5] *#6] ;



① to ⑤ indicate the order of operations.

Limitations

- **Brackets**

Brackets ([,]) are used to enclose an expression. Note that parentheses are used for comments.

- **Operation error**

Errors may occur when operations are performed.

Table 15.3(b) Errors involved in operations

Operation	Average error	Maximum error	Type of error
$a = b * c$	1.55×10^{-10}	4.66×10^{-10}	Relative error(*1) $\left \frac{\varepsilon}{a} \right $
$a = b / c$	4.66×10^{-10}	1.88×10^{-9}	
$a = \sqrt{b}$	1.24×10^{-9}	3.73×10^{-9}	
$a = b + c$ $a = b - c$	2.33×10^{-10}	5.32×10^{-10}	Min $\left \frac{\varepsilon}{b} \right $, $\left \frac{\varepsilon}{c} \right $ (*2)
$a = \text{SIN} [b]$ $a = \text{COS} [b]$	5.0×10^{-9}	1.0×10^{-8}	Absolute error(*3) $\left \varepsilon \right $ degrees
$a = \text{ATAN} [b] / [c]$ (*4)	1.8×10^{-6}	3.6×10^{-6}	

NOTE

- 1 The relative error depends on the result of the operation.
- 2 Smaller of the two types of errors is used.
- 3 The absolute error is constant, regardless of the result of the operation.
- 4 Function TAN performs SIN/COS.

- The precision of variable values is about 8 decimal digits. When very large numbers are handled in an addition or subtraction, the expected results may not be obtained.

Example:

When an attempt is made to assign the following values to variables #1 and #2:

#1=9876543210123.456

#2=987654327777.777

the values of the variables become:

#1=9876543200000.000

#2=9876543300000.000

In this case, when #3=#2-#1; is calculated, #3=100000.000 results. (The actual result of this calculation is slightly different because it is performed in binary.)

- Also be aware of errors that can result from conditional expressions using EQ, NE, GE, GT, LE, and LT.

Example:

IF[#1 EQ #2] is effected by errors in both #1 and #2, possibly resulting in an incorrect decision.

Therefore, instead find the difference between the two variables with IF[ABS[#1-#2]LT0.001].

Then, assume that the values of the two variables are equal when the difference does not exceed an allowable limit (0.001 in this case).

- Also, be careful when rounding down a value.

Example:

When #2=#1*1000; is calculated where #1=0.002;, the resulting value of variable #2 is not exactly 2 but 1.99999997.

Here, when #3=FIX[#2]; is specified, the resulting value of variable #1 is not 2.0 but 1.0. In this case, round down the value after correcting the error so that the result is greater than the expected number, or round it off as follows:

```
#3=FIX[#2+0.001]
```

```
#3=ROUND[#2]
```

- **Divisor**

When a divisor of zero is specified in a division or TAN[90], P/S alarm No. 112 occurs.

15.4 MACRO STATEMENTS AND NC STATEMENTS

The following blocks are referred to as macro statements:

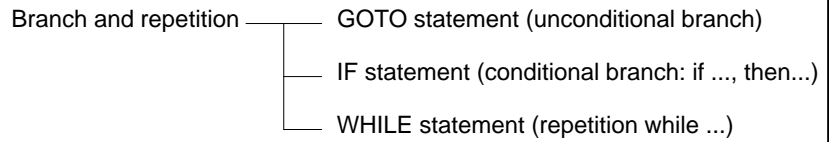
- **Blocks containing an arithmetic or logic operation (=)**
- **Blocks containing a control statement (such as GOTO, DO, END)**
- **Blocks containing a macro call command (such as macro calls by G65, G66, G67, or other G codes, or by M codes)** Any block other than a macro statement is referred to as an NC statement.

Explanations

- **Differences from NC statements**
 - Even when single block mode is on, the machine does not stop. Note, however, that the machine stops in the single block mode when bit 5 of parameter SBM No. 6000 is 1.
 - Macro blocks are not regarded as blocks that involve no movement in the cutter compensation mode (seeII-15.7).
- **NC statements that have the same property as macro statements**
 - NC statements that include a subprogram call command (such as subprogram calls by M98 or other M codes, or by T codes) and not include other command addresses except an O,N or L address have the same property as macro statements.
 - The blocks not include other command addresses except an O,N,P or L address have the same property as macro statements.

15.5 BRANCH AND REPETITION

In a program, the flow of control can be changed using the GOTO statement and IF statement. Three types of branch and repetition operations are used:



15.5.1 Unconditional Branch (GOTO Statement)

A branch to sequence number n occurs. When a sequence number outside of the range 1 to 99999 is specified, P/S alarm No. 128 occurs. A sequence number can also be specified using an expression.

<code>GOTO n ;</code> n: Sequence number (1 to 99999)

Example:

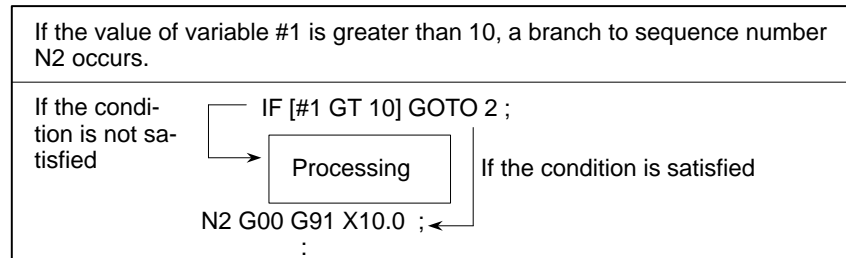
```
GOTO1;  
GOTO#10;
```

15.5.2 Conditional Branch (IF Statement)

Specify a conditional expression after IF.

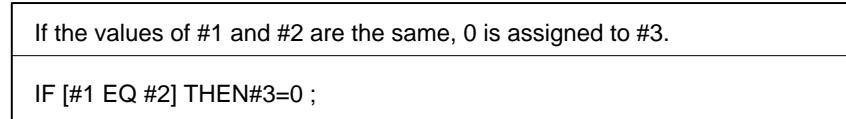
IF[<conditional expression>]GOTO n

If the specified conditional expression is satisfied, a branch to sequence number n occurs. If the specified condition is not satisfied, the next block is executed.



IF[<conditional expression>]THEN

If the specified conditional expression is satisfied, a predetermined macro statement is executed. Only a single macro statement is executed.



Explanations

- **Conditional expression**
- **Operators**

A conditional expression must include an operator inserted between two variables or between a variable and constant, and must be enclosed in brackets ([,]). An expression can be used instead of a variable.

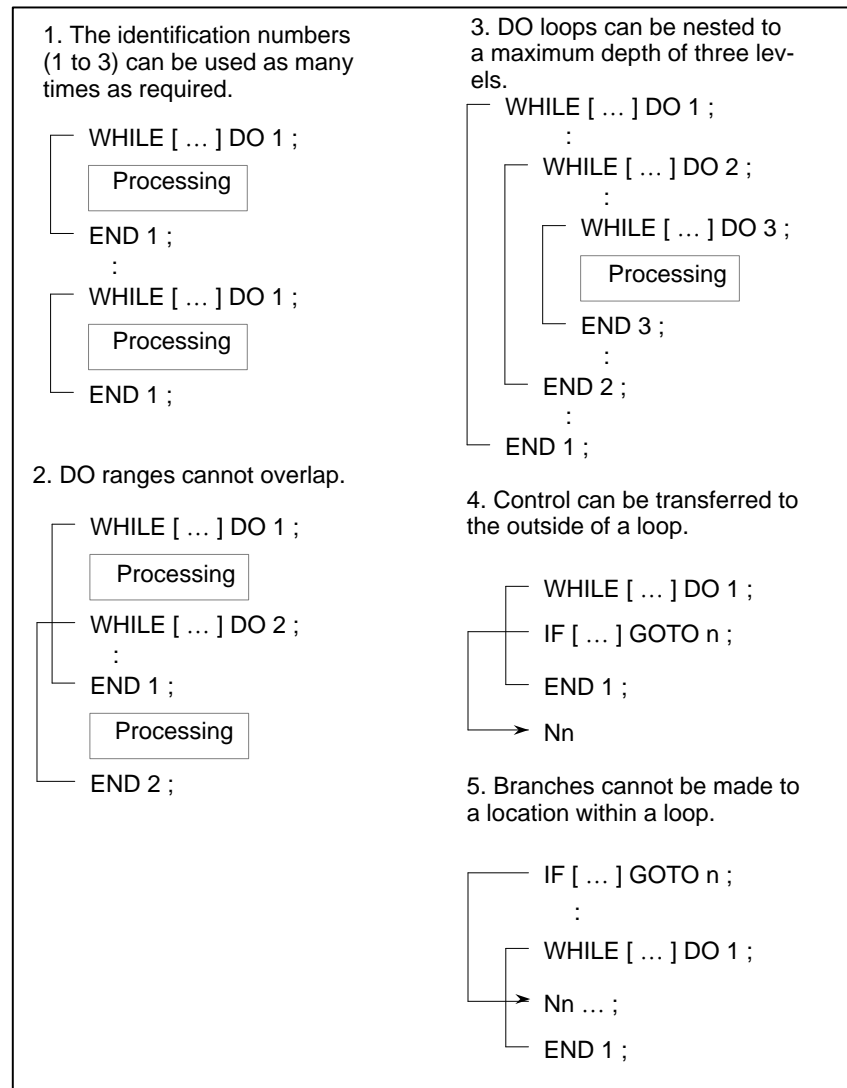
Operators each consist of two letters and are used to compare two values to determine whether they are equal or one value is smaller or greater than the other value. Note that the inequality sign cannot be used.

Table 15.5.2 Operators

Operator	Meaning
EQ	Equal to(=)
NE	Not equal to(≠)
GT	Greater than(>)
GE	Greater than or equal to(≥)
LT	Less than(<)
LE	Less than or equal to(≤)

• Nesting

The identification numbers (1 to 3) in a DO-END loop can be used as many times as desired. Note, however, when a program includes crossing repetition loops (overlapped DO ranges), P/S alarm No. 124 occurs.



Limitations

• Infinite loops

When DO m is specified without specifying the WHILE statement, an infinite loop ranging from DO to END is produced.

• Processing time

When a branch to the sequence number specified in a GOTO statement occurs, the sequence number is searched for. For this reason, processing in the reverse direction takes a longer time than processing in the forward direction. Using the WHILE statement for repetition reduces processing time.

• Undefined variable

In a conditional expression that uses EQ or NE, a <vacant> and zero have different effects. In other types of conditional expressions, a <vacant> is regarded as zero.

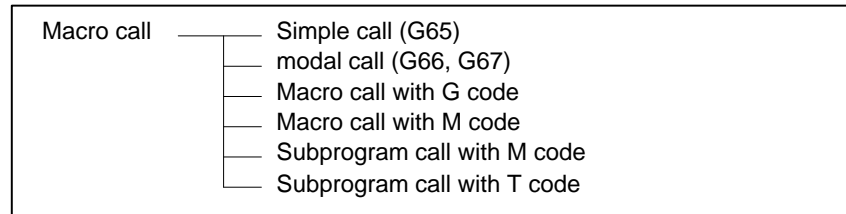
Sample program

The sample program below finds the total of numbers 1 to 10.

```
O0001;  
#1=0;  
#2=1;  
WHILE[#2 LE 10]DO 1;  
#1=#1+#2;  
#2=#2+1;  
END 1;  
M30;
```

15.6 MACRO CALL

A macro program can be called using the following methods:



Limitations

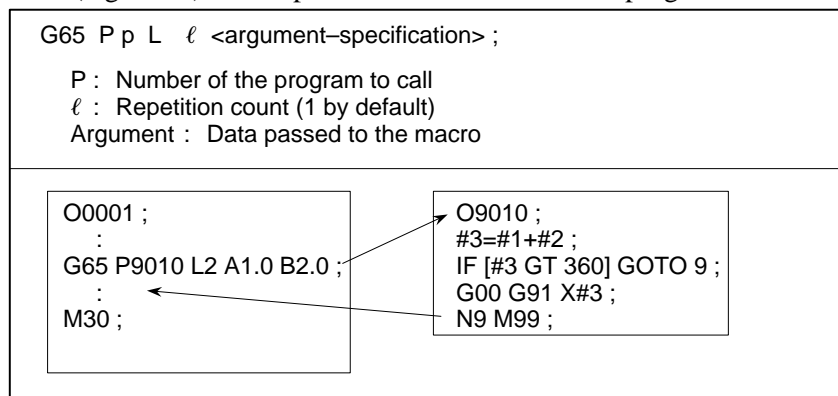
- **Differences between macro calls and subprogram calls**

Macro call (G65) differs from subprogram call (M98) as described below.

- With G65, an argument (data passed to a macro) can be specified. M98 does not have this capability.
- When an M98 block contains another NC command (for example, G01 X100.0 M98Pp), the subprogram is called after the command is executed. On the other hand, G65 unconditionally calls a macro.
- When an M98 block contains another NC command (for example, G01 X100.0 M98Pp), the machine stops in the single block mode. On the other hand, G65 does not stop the machine.
- With G65, the level of local variables changes. With M98, the level of local variables does not change.

15.6.1 Simple Call (G65)

When G65 is specified, the custom macro specified at address P is called. Data (argument) can be passed to the custom macro program.



Explanations

• Call

- After G65, specify at address P the program number of the custom macro to call.
- When a number of repetitions is required, specify a number from 1 to 9999 after address L. When L is omitted, 1 is assumed.
- By using argument specification, values are assigned to corresponding local variables.

• Argument specification

Two types of argument specification are available. Argument specification I uses letters other than G, L, O, N, and P once each. Argument specification II uses A, B, and C once each and also uses I, J, and K up to ten times. The type of argument specification is determined automatically according to the letters used.

Argument specification I

Address	Variable number
A	#1
B	#2
C	#3
D	#7
E	#8
F	#9
H	#11

Address	Variable number
I	#4
J	#5
K	#6
M	#13
Q	#17
R	#18
S	#19

Address	Variable number
T	#20
U	#21
V	#22
W	#23
X	#24
Y	#25
Z	#26

- Addresses G, L, N, O, and P cannot be used in arguments.
- Addresses that need not be specified can be omitted. Local variables corresponding to an omitted address are set to null.

Argument specification II

Argument specification II uses A, B, and C once each and uses I, J, and K up to ten times. Argument specification II is used to pass values such as three-dimensional coordinates as arguments.

Address	Variable number	Address	Variable number	Address	Variable number
A	#1	K ₃	#12	J ₇	#23
B	#2	I ₄	#13	K ₇	#24
C	#3	J ₄	#14	I ₈	#25
I ₁	#4	K ₄	#15	J ₈	#26
J ₁	#5	I ₅	#16	K ₈	#27
K ₁	#6	J ₅	#17	I ₉	#28
I ₂	#7	K ₅	#18	J ₉	#29
J ₂	#8	I ₆	#19	K ₉	#30
K ₂	#9	J ₆	#20	I ₁₀	#31
I ₃	#10	K ₆	#21	J ₁₀	#32
J ₃	#11	I ₇	#22	K ₁₀	#33

- Subscripts of I, J, and K for indicating the order of argument specification are not written in the actual program.

Limitations

- **Format**

G65 must be specified before any argument.

- **Mixture of argument specifications I and II**

The CNC internally identifies argument specification I and argument specification II. If a mixture of argument specification I and argument specification II is specified, the type of argument specification specified later takes precedence.

- **Position of the decimal point**

The units used for argument data passed without a decimal point correspond to the least input increment of each address. The value of an argument passed without a decimal point may vary according to the system configuration of the machine. It is good practice to use decimal points in macro call arguments to maintain program compatibility.

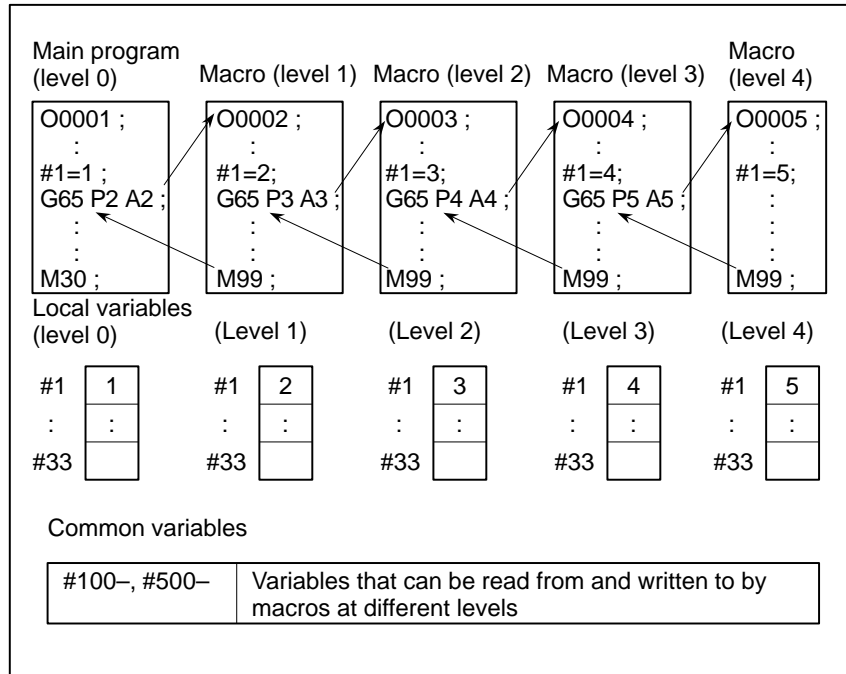
- **Call nesting**

Calls can be nested to a depth of four levels including simple calls (G65) and modal calls (G66). This does not include subprogram calls (M98).

- **Local variable levels**

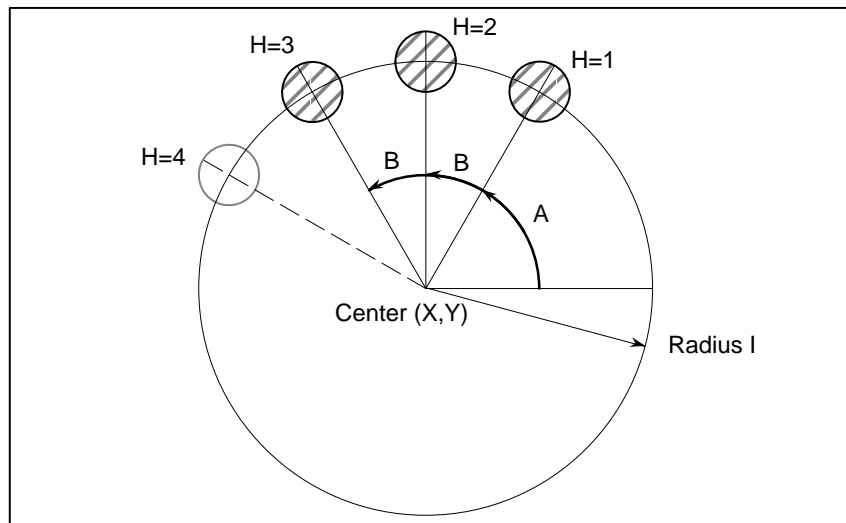
- Local variables from level 0 to 4 are provided for nesting.
- The level of the main program is 0.
- Each time a macro is called (with G65 or G66), the local variable level is incremented by one. The values of the local variables at the previous level are saved in the CNC.

- When M99 is executed in a macro program, control returns to the calling program. At that time, the local variable level is decremented by one; the values of the local variables saved when the macro was called are restored.



Sample program (bolt hole circle)

A macro is created which drills H holes at intervals of B degrees after a start angle of A degrees along the periphery of a circle with radius I. The center of the circle is (X,Y). Commands can be specified in either the absolute or incremental mode. To drill in the clockwise direction, specify a negative value for B.



- **Calling format**

G65 P9100 X x Y y Z z R r F f I i A a B b H h ;

X: X coordinate of the center of the circle
(absolute or incremental specification)(#24)
 Y: Y coordinate of the center of the circle
(absolute or incremental specification)(#25)
 Z: Hole depth (#26)
 R: Coordinates of an approach point (#18)
 F: Cutting feedrate (#9)
 I : Radius of the circle (#4)
 A: Drilling start angle (#1)
 B: Incremental angle (clockwise when a negative value is specified)
(#2)
 H: Number of holes (#11)

- **Program calling a macro program**

```
O0002;
G90 G92 X0 Y0 Z100.0;
G65 P9100 X100.0 Y50.0 R30.0 Z-50.0 F500 I100.0 A0 B45.0 H5;
M30;
```

- **Macro program (called program)**

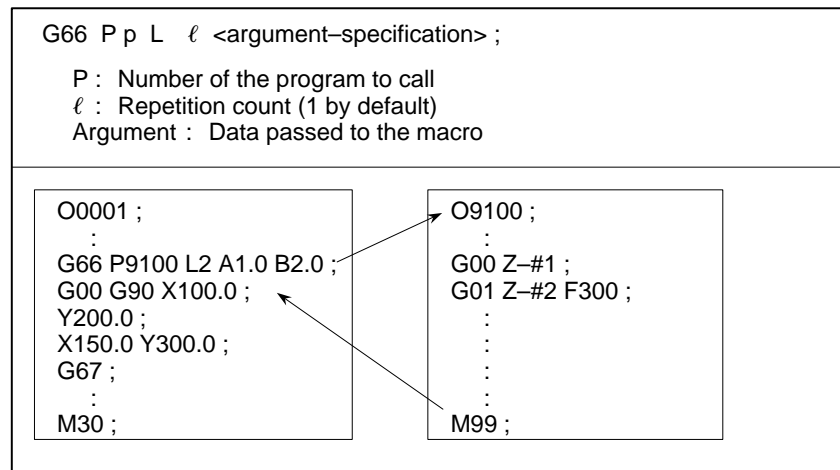
```
O9100;
#3=#4003; Stores G code of group 3.
G81 Z#26 R#18 F#9 K0; (Note) . Drilling cycle.
Note: L0 can also be used.
IF[#3 EQ 90]GOTO 1; Branches to N1 in the G90 mode.
#24=#5001+#24; Calculates the X coordinate of the center.
#25=#5002+#25; Calculates the Y coordinate of the center.
N1 WHILE[#11 GT 0]DO 1;
. . Until the number of remaining holes reaches 0
#5=#24+#4*COS[#1]; Calculates a drilling position on the X-axis.
#6=#25+#4*SIN[#1]; Calculates a drilling position on the Y-axis.
G90 X#5 Y#6; Performs drilling after moving to the target position.
#1=#1+#2; Updates the angle.
#11=#11-1; Decrements the number of holes.
END 1;
G#3 G80; Returns the G code to the original state.
M99;
```

Meaning of variables:

#3: Stores the G code of group 3.
#5: X coordinate of the next hole to drill
#6: Y coordinate of the next hole to drill

15.6.2 Modal Call (G66)

Once G66 is issued to specify a modal call a macro is called after a block specifying movement along axes is executed. This continues until G67 is issued to cancel a modal call.



Explanations

- **Call**
 - After G66, specify at address P a program number subject to a modal call.
 - When a number of repetitions is required, a number from 1 to 9999 can be specified at address L.
 - As with a simple call (G65), data passed to a macro program is specified in arguments.
- **Cancellation**

When a G67 code is specified, modal macro calls are no longer performed in subsequent blocks.
- **Call nesting**

Calls can be nested to a depth of four levels including simple calls (G65) and modal calls (G66). This does not include subprogram calls (M98).
- **Modal call nesting**

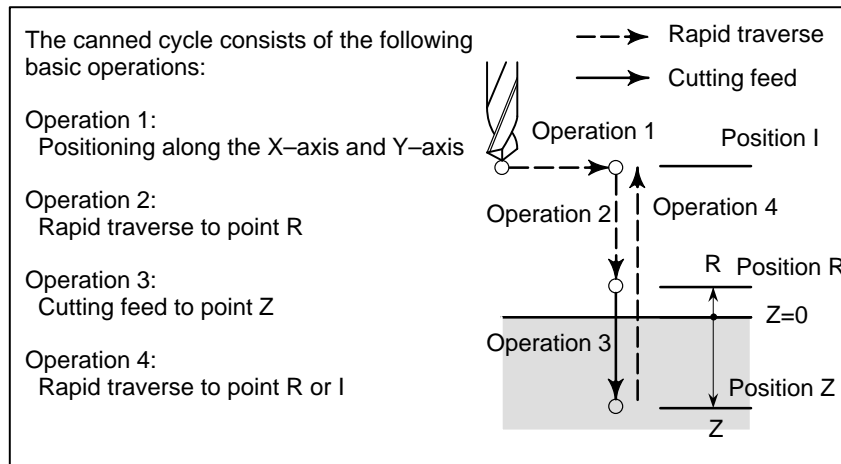
Modal calls can be nested by specifying another G66 code during a modal call.

Limitations

- In a G66 block, no macros can be called.
- G66 needs to be specified before any arguments.
- No macros can be called in a block which contains a code such as a miscellaneous function that does not involve movement along an axis.
- Local variables (arguments) can only be set in G66 blocks. Note that local variables are not set each time a modal call is performed.

Sample program

The same operation as the drilling canned cycle G81 is created using a custom macro and the machining program makes a modal macro call. For program simplicity, all drilling data is specified using absolute values.



• Calling format

```
G65 P9110 Xx Yy Zz Rr Ff Ll;
```

X: X coordinate of the hole (absolute specification only) (#24)
 Y: Y coordinate of the hole (absolute specification only) (#25)
 Z: Coordinates of position Z (absolute specification only) (#26)
 R: Coordinates of position R (absolute specification only) (#18)
 F: Cutting feedrate (#9)
 L: Repetition count

• Program that calls a macro program

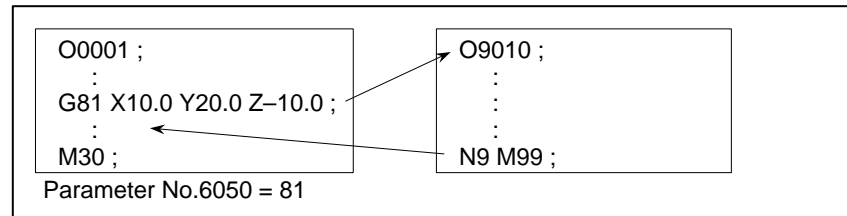
```
O0001;  
G28 G91 X0 Y0 Z0;  
G92 X0 Y0 Z50.0;  
G00 G90 X100.0 Y50.0;  
G66 P9110 Z-20.0 R5.0 F500;  
G90 X20.0 Y20.0;  
X50.0;  
Y50.0;  
X70.0 Y80.0;  
G67;  
M30;
```

• Macro program (program called)

```
O9110;  
#1=#4001; Stores G00/G01.  
#3=#4003; Stores G90/G91.  
#4=#4109; Stores the cutting feedrate.  
#5=#5003; Stores the Z coordinate at the start of drilling.  
G00 G90 Z#18; Positioning at position R  
G01 Z#26 F#9; Cutting feed to position Z  
IF[#4010 EQ 98]GOTO 1; Return to position I  
G00 Z#18; Positioning at position R  
GOTO 2;  
N1 G00 Z#5; Positioning at position I  
N2 G#1 G#3 F#4; Restores modal information.  
M99;
```

15.6.3 Macro Call Using G Code

By setting a G code number used to call a macro program in a parameter, the macro program can be called in the same way as for a simple call (G65).



Explanations

By setting a G code number from 1 to 9999 used to call a custom macro program (O9010 to O9019) in the corresponding parameter (N0.6050 to No.6059), the macro program can be called in the same way as with G65. For example, when a parameter is set so that macro program O9010 can be called with G81, a user-specific cycle created using a custom macro can be called without modifying the machining program.

- **Correspondence between parameter numbers and program numbers**

Program number	Parameter number
O9010	6050
O9011	6051
O9012	6052
O9013	6053
O9014	6054
O9015	6055
O9016	6056
O9017	6057
O9018	6058
O9019	6059

- **Repetition**
- **Argument specification**

As with a simple call, a number of repetitions from 1 to 9999 can be specified at address L.

As with a simple call, two types of argument specification are available: Argument specification I and argument specification II. The type of argument specification is determined automatically according to the addresses used.

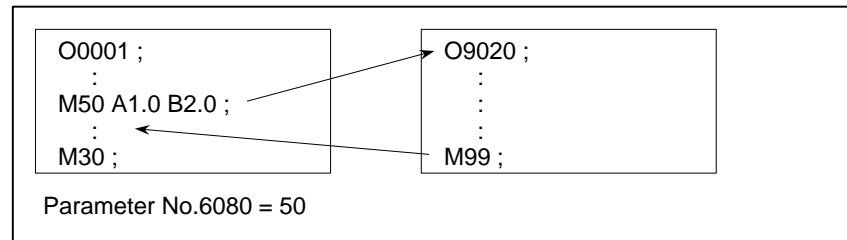
Limitations

- **Nesting of calls using G codes**

In a program called with a G code, no macros can be called using a G code. A G code in such a program is treated as an ordinary G code. In a program called as a subprogram with an M or T code, no macros can be called using a G code. A G code in such a program is also treated as an ordinary G code.

15.6.4 Macro Call Using an M Code

By setting an M code number used to call a macro program in a parameter, the macro program can be called in the same way as with a simple call (G65).



Explanations

By setting an M code number from 1 to 99999999 used to call a custom macro program (9020 to 9029) in the corresponding parameter (No.6080 to No.6089), the macro program can be called in the same way as with G65.

- **Correspondence between parameter numbers and program numbers**

Program number	Parameter number
O9020	6080
O9021	6081
O9022	6082
O9023	6083
O9024	6084
O9025	6085
O9026	6086
O9027	6087
O9028	6088
O9029	6089

- **Repetition**
- **Argument specification**

As with a simple call, a number of repetitions from 1 to 9999 can be specified at address L.

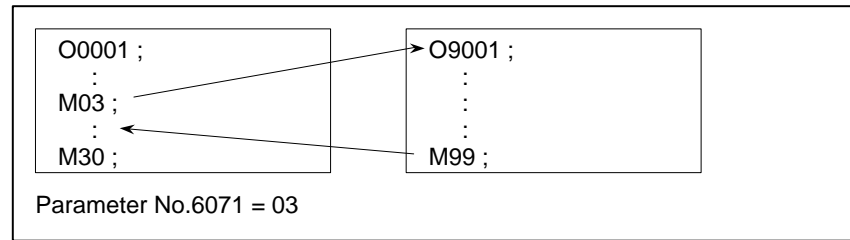
As with a simple call, two types of argument specification are available: Argument specification I and argument specification II. The type of argument specification is determined automatically according to the addresses used.

Limitations

- An M code used to call a macro program must be specified at the start of a block.
- In a macro called with a G code or in a program called as a subprogram with an M or T code, no macros can be called using an M code. An M code in such a macro or program is treated as an ordinary M code.

15.6.5 Subprogram Call Using an M Code

By setting an M code number used to call a subprogram (macro program) in a parameter, the macro program can be called in the same way as with a subprogram call (M98).



Explanations

By setting an M code number from 1 to 99999999 used to call a subprogram in a parameter (No.6071 to No. 6079), the corresponding custom macro program (O9001 to O9009) can be called in the same way as with M98.

- **Correspondence between parameter numbers and program numbers**

Program number	Parameter number
O9001	6071
O9002	6072
O9003	6073
O9004	6074
O9005	6075
O9006	6076
O9007	6077
O9008	6078
O9009	6079

- **Repetition**

As with a simple call, a number of repetitions from 1 to 9999 can be specified at address L.

- **Argument specification**

Argument specification is not allowed.

- **M code**

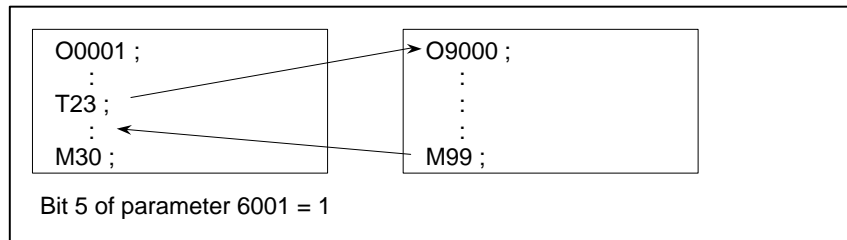
An M code in a macro program that has been called is treated as an ordinary M code.

Limitations

In a macro called with a G code or in a program called with an M or T code, no subprograms can be called using an M code. An M code in such a macro or program is treated as an ordinary M code.

15.6.6 Subprogram Calls Using a T Code

By enabling subprograms (macro program) to be called with a T code in a parameter, a macro program can be called each time the T code is specified in the machining program.



Explanations

- **Call**

By setting bit 5 of parameter TCS No.6001 to 1, the macro program O9000 can be called when a T code is specified in the machining program. A T code specified in a machining program is assigned to common variable #149.

Limitations

In a macro called with a G code or in a program called with an M or T code, no subprograms can be called using a T code. A T code in such a macro or program is treated as an ordinary T code.

15.6.7 Sample Program

Conditions

By using the subprogram call function that uses M codes, the cumulative usage time of each tool is measured.

- The cumulative usage time of each of tools T01 to T05 is measured. No measurement is made for tools with numbers greater than T05.
- The following variables are used to store the tool numbers and measured times:

#501	Cumulative usage time of tool number 1
#502	Cumulative usage time of tool number 2
#503	Cumulative usage time of tool number 3
#504	Cumulative usage time of tool number 4
#505	Cumulative usage time of tool number 5

- Usage time starts being counted when the M03 command is specified and stops when M05 is specified. System variable #3002 is used to measure the time during which the cycle start lamp is on. The time during which the machine is stopped by feed hold and single block stop operation is not counted, but the time used to change tools and pallets is included.

Operation check

- **Parameter setting**

Set 3 in parameter No.6071, and set 05 in parameter No.6072.

- **Variable value setting**

Set 0 in variables #501 to #505.

- **Program that calls a macro program**

```

O0001;
T01 M06;
M03;
⋮
M05; Changes #501.
T02 M06;
M03;
⋮
M05; Changes #502.
T03 M06;
M03;
⋮
M05; Changes #503.
T04 M06;
M03;
⋮
M05; Changes #504.
T05 M06;
M03;
⋮
M05; Changes #505.
M30;

```

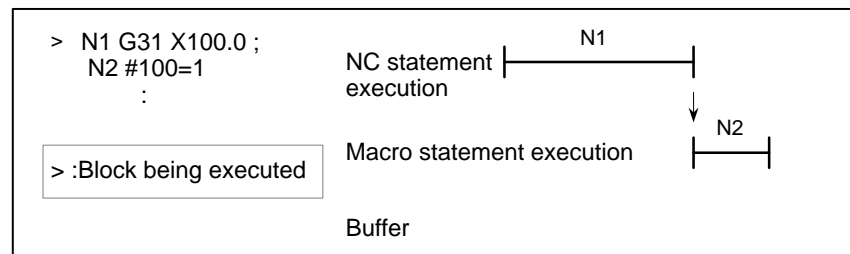
**Macro program
(program called)****O9001(M03);** Macro to start counting**M01;****IF[#4120 EQ 0]GOTO 9;** No tool specified**IF[#4120 GT 5]GOTO 9;** Out-of-range tool number**#3002=0;** Clears the timer.**N9 M03;** Rotates the spindle in the forward direction.**M99;****O9002(M05);** Macro to end counting**M01;****IF[#4120 EQ 0]GOTO 9;** No tool specified**IF[#4120 GT 5]GOTO 9;** Out-of-range tool number**#[500+#4120]=#3002+#[500+#4120];** Calculates cumulative time.**N9 M05;** Stops the spindle.**M99;**

15.7 PROCESSING MACRO STATEMENTS

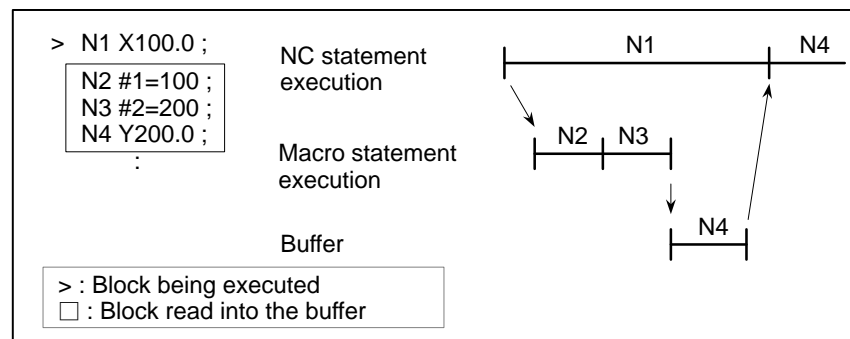
For smooth machining, the CNC prereads the NC statement to be performed next. This operation is referred to as buffering. In cutter compensation mode (G41, G42), the NC prereads NC statements two or three blocks ahead to find intersections. Macro statements for arithmetic expressions and conditional branches are processed as soon as they are read into the buffer. Blocks containing M00, M01, M02, or M30, blocks containing M codes for which buffering is suppressed by setting parameters No.3411 to No.3420, and blocks containing G31 are not preread.

Explanations

- When the next block is not buffered (M codes that are not buffered, G31, etc.)

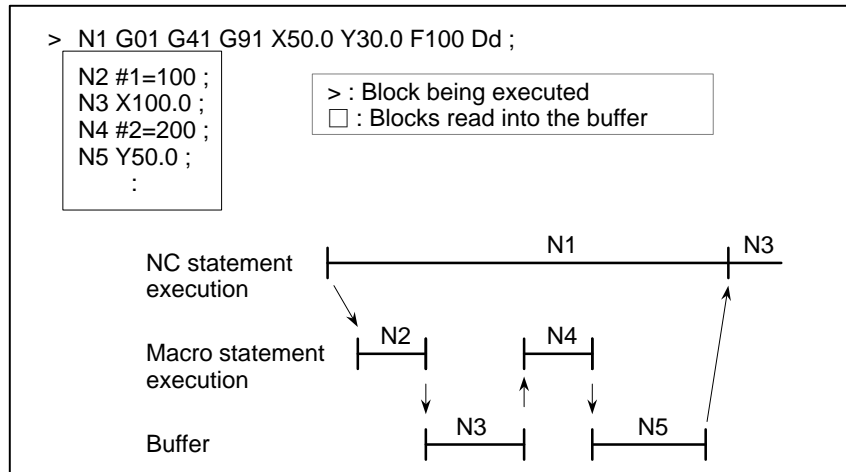


- Buffering the next block in other than cutter compensation mode (G41, G42) (normally prereading one block)



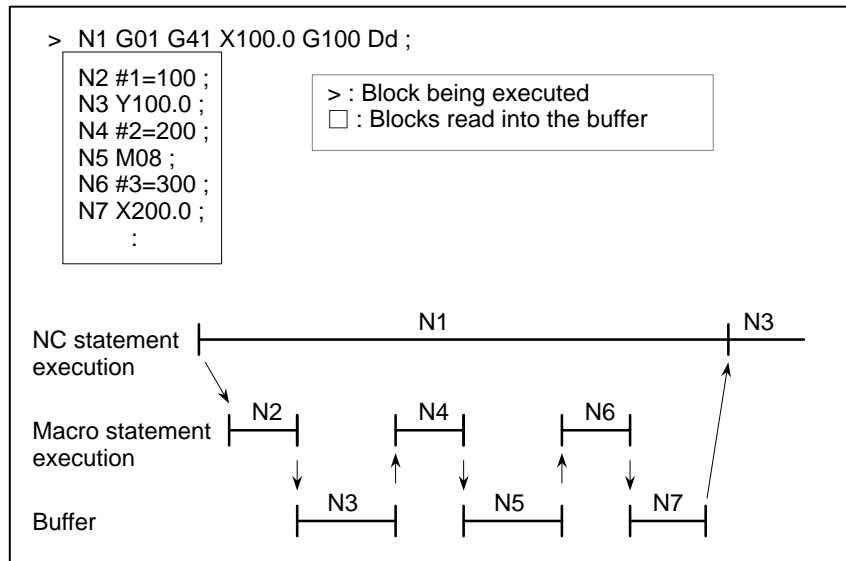
When N1 is being executed, the next NC statement (N4) is read into the buffer. The macro statements (N2, N3) between N1 and N4 are processed during execution of N1.

● **Buffering the next block in cutter compensation mode (G41, G42)**



When N1 is being executed, the NC statements in the next two blocks (up to N5) are read into the buffer. The macro statements (N2, N4) between N1 and N5 are processed during execution of N1.

● **When the next block involves no movement in cutter compensation C (G41, G42) mode**



When the NC1 block is being executed, the NC statements in the next two blocks (up to N5) are read into the buffer. Since N5 is a block that involves no movement, an intersection cannot be calculated. In this case, the NC statements in the next three blocks (up to N7) are read. The macro statements (N2, N4, and N6) between N1 and N7 are processed during execution of N1.

15.8 REGISTERING CUSTOM MACRO PROGRAMS

Custom macro programs are similar to subprograms. They can be registered and edited in the same way as subprograms. The storage capacity is determined by the total length of tape used to store both custom macros and subprograms.

15.9 LIMITATIONS



- **MDI operation**

The macro call command can be specified in MDI mode. During automatic operation, however, it is impossible to switch to the MDI mode for a macro program call.
- **Sequence number search**

A custom macro program cannot be searched for a sequence number.
- **Single block**

Even while a macro program is being executed, blocks can be stopped in the single block mode.
A block containing a macro call command (G65, G66, or G67) does not stop even when the single block mode is on. Blocks containing arithmetic operation commands and control commands can be stopped in single block mode by setting SBM (bit 5 of parameter 6000) to 1.
Single block stop operation is used for testing custom macro programs. Note that when a single block stop occurs at a macro statement in cutter compensation C mode, the statement is assumed to be a block that does not involve movement, and proper compensation cannot be performed in some cases. (Strictly speaking, the block is regarded as specifying a movement with a travel distance 0.)
- **Optional block skip**

A / appearing in the middle of an <expression> (enclosed in brackets [] on the right-hand side of an arithmetic expression) is regarded as a division operator; it is not regarded as the specifier for an optional block skip code.
- **Operation in EDIT mode**

By setting NE8 (bit 0 of parameter 3202) and NE9 (bit 4 of parameter 3202) to 1, deletion and editing are disabled for custom macro programs and subprograms with program numbers 8000 to 8999 and 9000 to 9999. This prevents registered custom macro programs and subprograms from being destroyed by accident. When the entire memory is cleared (by pressing the  and  keys at the same time to turn on the power), the contents of memory such as custom macro programs are deleted.
- **Reset**

With a reset operation, local variables and common variables #100 to #149 are cleared to null values. They can be prevented from clearing by setting, CLV and CCV (bits 7 and 6 of parameter 6001). System variables #1000 to #1133 are not cleared.
A reset operation clears any called states of custom macro programs and subprograms, and any DO states, and returns control to the main program.
- **Display of the PROGRAM RESTART**

As with M98, the M and T codes used for subprogram calls are not displayed.
- **Feed hold**

When a feed hold is enabled during execution of a macro statement, the machine stops after execution of the macro statement. The machine also stops when a reset or alarm occurs.
- **Constant values that can be used in <expression>**

+0.0000001 to +999999999
-999999999 to -0.0000001
The number of significant digits is 8 (decimal). If this range is exceeded, P/S alarm No. 003 occurs.

15.10 EXTERNAL OUTPUT COMMANDS

In addition to the standard custom macro commands, the following macro commands are available. They are referred to as external output commands.

- **BPRNT**
- **DPRNT**
- **POPEN**
- **PCLOS**

These commands are provided to output variable values and characters through the reader/punch interface.

Explanations

Specify these commands in the following order:

Open command: **POPEN**

Before specifying a sequence of data output commands, specify this command to establish a connection to an external input/output device.

Data output command: **BPRNT or DPRNT**

Specify necessary data output.

Close command: **PCLOS**

When all data output commands have completed, specify PCLOS to release a connection to an external input/output device.

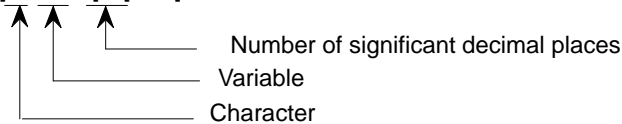
- **Open command POPEN**

POPEN

POPEN establishes a connection to an external input/output device. It must be specified before a sequence of data output commands. The CNC outputs a DC2 control code.

- **Data output command BPRNT**

BPRNT [a #b [c] ...]



The BPRNT command outputs characters and variable values in binary.

(i) Specified characters are converted to the codes according to the setting data (ISO) that is output at that time.

Specifiable characters are as follows:

- **Letters (A to Z)**
- **Numbers**
- **Special characters (*, /, +, -, etc.)**

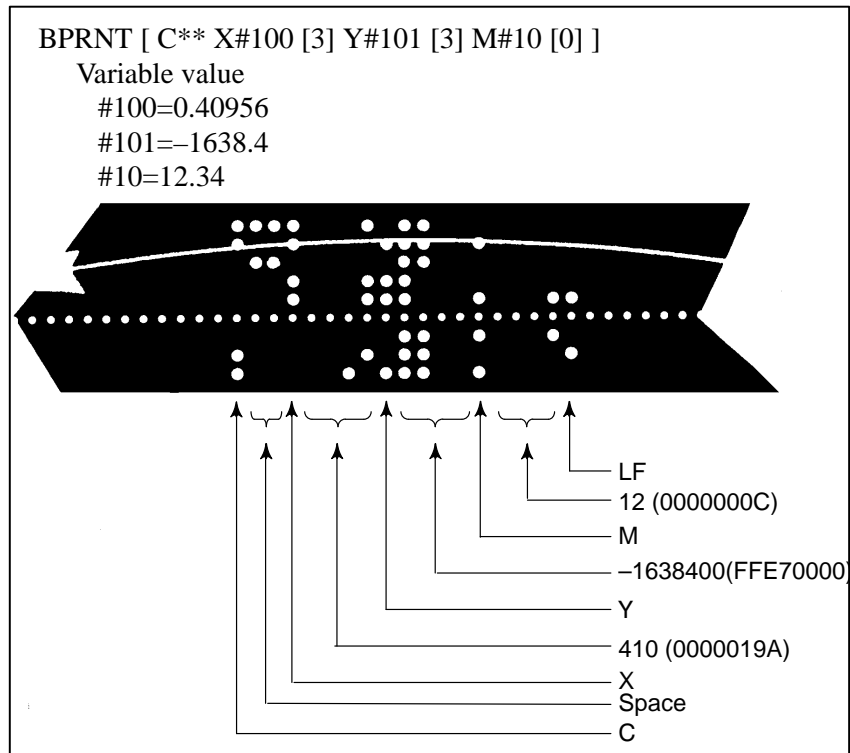
An asterisk (*) is output by a space code.

(ii) All variables are stored with a decimal point. Specify a variable followed by the number of significant decimal places enclosed in brackets. A variable value is treated as 2-word (32-bit) data, including the decimal digits. It is output as binary data starting from the highest byte.

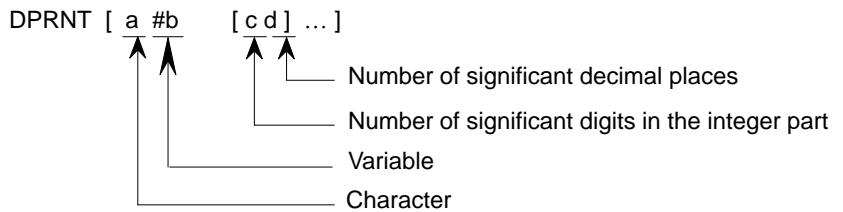
(iii) When specified data has been output, an EOB code is output according to the setting code (ISO).

(iv) Null variables are regarded as 0.

Example)



• Data output command
DPRNT



The DPRNT command outputs characters and each digit in the value of a variable according to the code set in the settings (ISO).

(i) For an explanation of the DPRNT command, see Items (i), (iii), and (iv) for the BPRNT command.

(ii) When outputting a variable, specify # followed by the variable number, then specify the number of digits in the integer part and the number of decimal places enclosed in brackets.

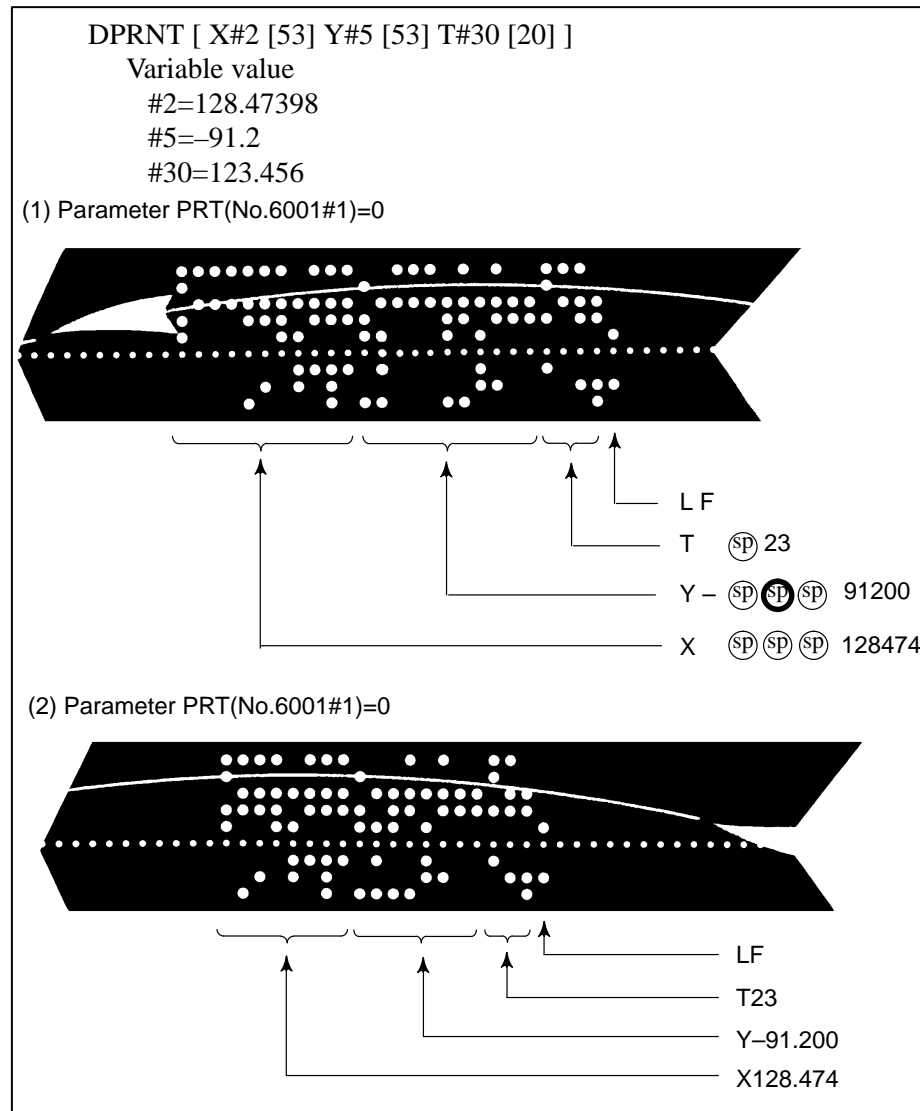
One code is output for each of the specified number of digits, starting with the highest digit. For each digit, a code is output according to the settings (ISO). The decimal point is also output using a code set in the settings (ISO).

Each variable must be a numeric value consisting of up to eight digits. When high-order digits are zeros, these zeros are not output if PRT (bit 1 of parameter 6001) is 1. If parameter PRT is 0, a space code is output each time a zero is encountered.

When the number of decimal places is not zero, digits in the decimal part are always output. If the number of decimal places is zero, no decimal point is output.

When PRT (bit 1 of parameter 6001) is 0, a space code is output to indicate a positive number instead of +; if parameter PRT is 1, no code is output.

Example)



- Close command PCLOS

PCLOS ;

The PCLOS command releases a connection to an external input/output device. Specify this command when all data output commands have terminated. DC4 control code is output from the CNC.

- Required setting

Specify the channel use for setting data (I/O channel). According to the specification of this data, set data items (such as the baud rate) for the reader/punch interface.

I/O channel 0 : Parameters (No.101, No.102 and No.103)

I/O channel 1 : Parameters (No.111, No.112 and No.113)

I/O channel 2 : Parameters (No.112, No.122 and No.123)

Never specify the output device FANUC Cassette or Floppy for punching. When specifying a DPRNT command to output data, specify whether leading zeros are output as spaces (by setting PRT (bit 1 of parameter 6001) to 1 or 0).

To indicate the end of a line of data in ISO code, specify whether to use only an LF (CRO, of bit 4 of parameter 6001 is 0) or an LF and CR (CRO of bit 4 of parameter 6001 is 1).

NOTE

- 1 It is not necessary to always specify the open command (POPEN), data output command (BPRNT, DPRNT), and close command (PCLOS) together. Once an open command is specified at the beginning of a program, it does not need to be specified again except after a close command was specified.
- 2 Be sure to specify open commands and close commands in pairs. Specify the close command at the end of the program. However, do not specify a close command if no open command has been specified.
- 3 When a reset operation is performed while commands are being output by a data output command, output is stopped and subsequent data is erased. Therefore, when a reset operation is performed by a code such as M30 at the end of a program that performs data output, specify a close command at the end of the program so that processing such as M30 is not performed until all data is output.
- 4 Abbreviated macro words enclosed in brackets [] remains unchanged. However, note that when the characters in brackets are divided and input several times, the second and subsequent abbreviations are converted and input.
- 5 O can be specified in brackets []. Note that when the characters in brackets [] are divided and input several times, O is omitted in the second and subsequent inputs.

15.11 INTERRUPTION TYPE CUSTOM MACRO

When a program is being executed, another program can be called by inputting an interrupt signal (UINT) from the machine. This function is referred to as an interruption type custom macro function. Program an interrupt command in the following format:

Format

M96 P○○○○○ ;	Enables custom macro interrupt
M97 ;	Disables custom macro interrupt

Explanations

Use of the interruption type custom macro function allows the user to call a program during execution of an arbitrary block of another program. This allows programs to be operated to match situations which vary from time to time.

- (1) When a tool abnormality is detected, processing to handle the abnormality is started by an external signal.
- (2) A sequence of machining operations is interrupted by another machining operation without the cancellation of the current operation.
- (3) At regular intervals, information on current machining is read.

Listed above are examples like adaptive control applications of the interruption type custom macro function.

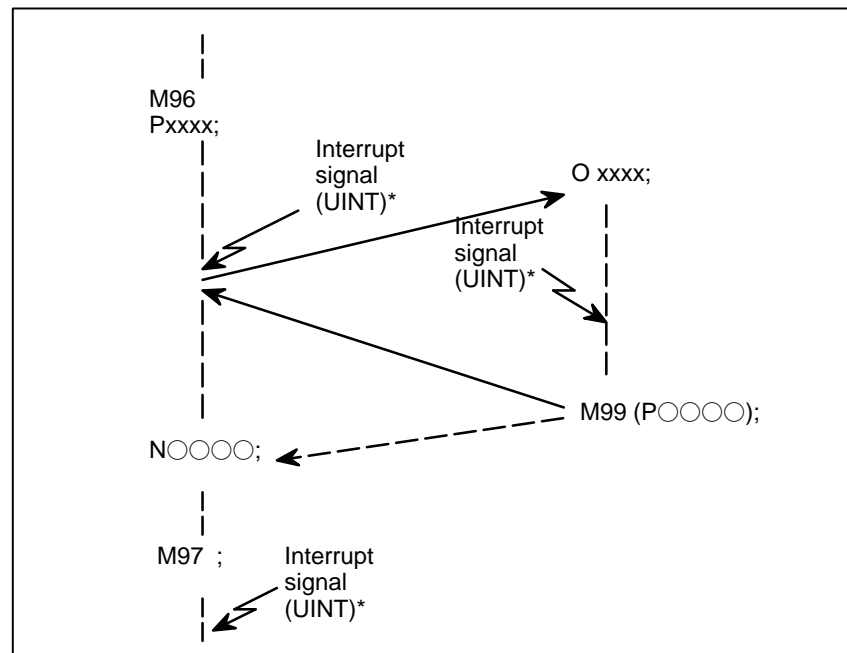


Fig 15.11 Interruption type custom macro function

When `M96Pxxxx` is specified in a program, subsequent program operation can be interrupted by an interrupt signal (UINT) input to execute the program specified by `Pxxxx`.

When the interrupt signal (UINT, marked by * in Fig. 15.11 is input during execution of the interrupt program or after `M97` is specified, it is ignored.

15.11.1 Specification Method

Explanations

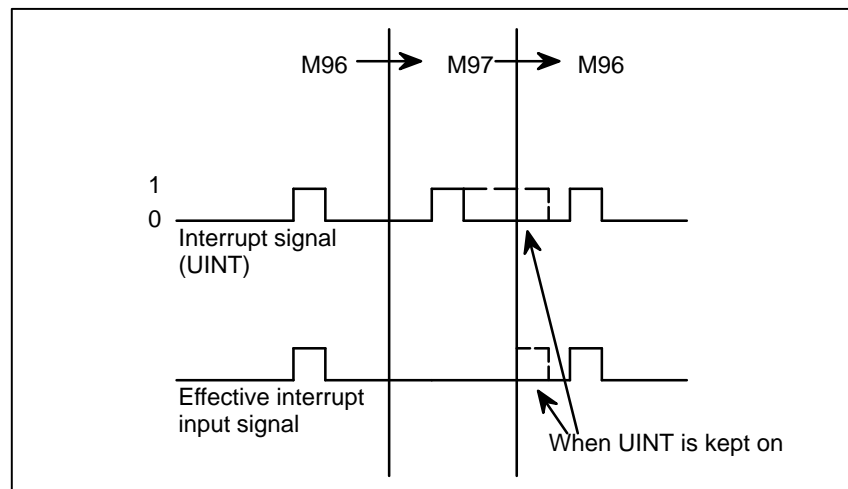
- **Interrupt conditions**

A custom macro interrupt is available only during program execution. It is enabled under the following conditions

- **When memory operation or MDI operation is selected**
- **When STL (start lamp) is on**
- **When a custom macro interrupt is not currently being processed**

- **Specification**

Generally, the custom macro interrupt function is used by specifying M96 to enable the interrupt signal (UINT) and M97 to disable the signal. Once M96 is specified, a custom macro interrupt can be initiated by the input of the interrupt signal (UINT) until M97 is specified or the NC is reset. After M97 is specified or the NC is reset, no custom macro interrupts are initiated even when the interrupt signal (UINT) is input. The interrupt signal (UINT) is ignored until another M96 command is specified.



The interrupt signal (UINT) becomes valid after M96 is specified. Even when the signal is input in M97 mode, it is ignored. When the signal input in M97 mode is kept on until M96 is specified, a custom macro interrupt is initiated as soon as M96 is specified (only when the status-triggered scheme is employed); when the edge-triggered scheme is employed, the custom macro interrupt is not initiated even when M96 is specified.

NOTE

For the status-triggered and edge-triggered schemes, see Item "Custom macro interrupt signal (UINT)" of II- 15.11.2.

15.11.2

Details of Functions

Explanations

- **Subprogram-type interrupt and macro-type interrupt**

There are two types of custom macro interrupts: Subprogram-type interrupts and macro-type interrupts. The interrupt type used is selected by MSB (bit 5 of parameter 6003).

(a) Subprogram-type interrupt

An interrupt program is called as a subprogram. This means that the levels of local variables remain unchanged before and after the interrupt. This interrupt is not included in the nesting level of subprogram calls.

(b) Macro-type interrupt

An interrupt program is called as a custom macro. This means that the levels of local variables change before and after the interrupt. The interrupt is not included in the nesting level of custom macro calls. When a subprogram call or a custom macro call is performed within the interrupt program, this call is included in the nesting level of subprogram calls or custom macro calls. Arguments cannot be passed from the current program even when the custom macro interrupt is a macro-type interrupt.

- **M codes for custom macro interrupt control**

In general, custom macro interrupts are controlled by M96 and M97. However, these M codes, may already being used for other purposes (such as an M function or macro M code call) by some machine tool builders. For this reason, MPR (bit 4 of parameter 6003) is provided to set M codes for custom macro interrupt control.

When specifying this parameter to use the custom macro interrupt control M codes set by parameters, set parameters 6033 and 6034 as follows:

Set the M code to enable custom macro interrupts in parameter 6033, and set the M code to disable custom macro interrupts in parameter 6034.

When specifying that parameter-set M codes are not used, M96 and M97 are used as the custom macro control M codes regardless of the settings of parameters 6033 and 6034.

The M codes used for custom macro interrupt control are processed internally (they are not output to external units). However, in terms of program compatibility, it is undesirable to use M codes other than M96 and M97 to control custom macro interrupts.

- **Custom macro interrupts and NC statements**

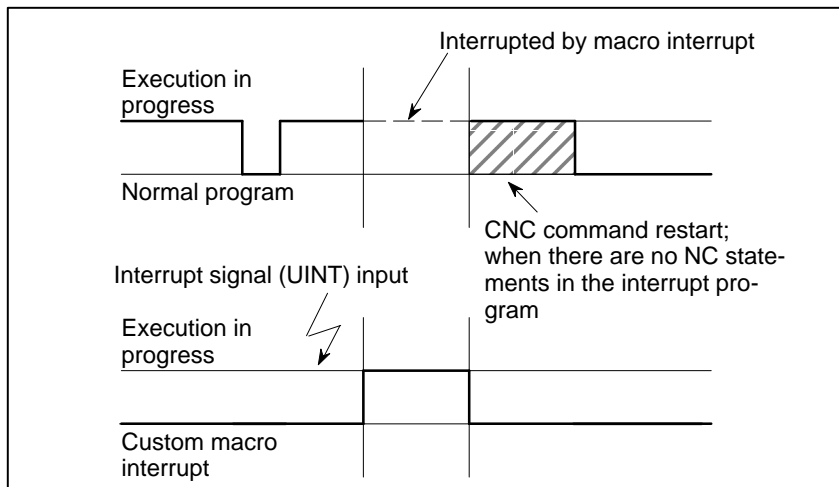
When performing a custom macro interrupt, the user may want to interrupt the NC statement being executed, or the user may not want to perform the interrupt until the execution of the current block is completed. MIN (bit 2 of parameter 6003) is used to select whether to perform interrupts even in the middle of a block or to wait until the end of the block.

**Type I
(when an interrupt is performed even in the middle of a block)**

(i) When the interrupt signal (UINT) is input, any movement or dwell being performed is stopped immediately and the interrupt program is executed.

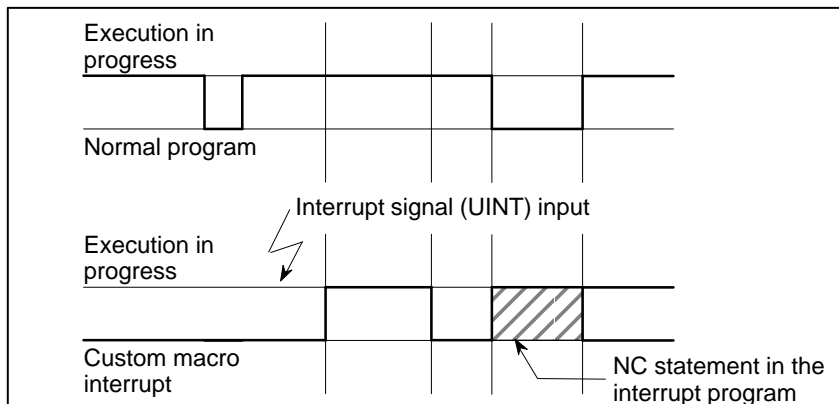
(ii) If there are NC statements in the interrupt program, the command in the interrupted block is lost and the NC statement in the interrupt program is executed. When control is returned to the interrupted program, the program is restarted from the next block after the interrupted block.

- (iii) If there are no NC statements in the interrupt program, control is returned to the interrupted program by M99, then the program is restarted from the command in the interrupted block.



**Type II
(when an interrupt is performed at the end of the block)**

- (i) If the block being executed is not a block that consists of several cycle operations such as a drilling canned cycle and automatic reference position return (G28), an interrupt is performed as follows:
When an interrupt signal (UINT) is input, macro statements in the interrupt program are executed immediately unless an NC statement is encountered in the interrupt program. NC statements are not executed until the current block is completed.
- (ii) If the block being executed consists of several cycle operations, an interrupt is performed as follows:
When the last movement in the cycle operations is started, macro statements in the interrupt program are executed unless an NC statement is encountered. NC statements are executed after all cycle operations are completed.



- **Conditions for enabling and disabling the custom macro interrupt signal**

The interrupt signal becomes valid after execution starts of a block that contains M96 for enabling custom macro interrupts. The signal becomes invalid when execution starts of a block that contains M97.

While an interrupt program is being executed, the interrupt signal becomes invalid. The signal become valid when the execution of the block that immediately follows the interrupted block in the main program is started after control returns from the interrupt program. In type I, if the interrupt program consists of only macro statements, the interrupt signal becomes valid when execution of the interrupted block is started after control returns from the interrupt program.

- **Custom macro interrupt during execution of a block that involves cycle operation**

- For type I**

Even when cycle operation is in progress, movement is interrupted, and the interrupt program is executed. If the interrupt program contains no NC statements, the cycle operation is restarted after control is returned to the interrupted program. If there are NC statements, the remaining operations in the interrupted cycle are discarded, and the next block is executed.

- For type II**

When the last movement of the cycle operation is started, macro statements in the interrupt program are executed unless an NC statement is encountered. NC statements are executed after cycle operation is completed.

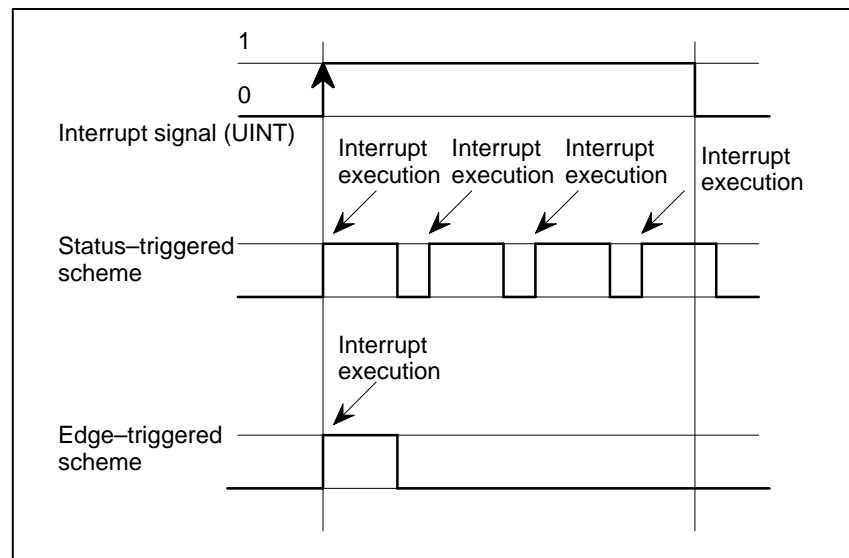
- **Custom macro interrupt signal (UINT)**

There are two schemes for custom macro interrupt signal (UINT) input: The status-triggered scheme and edge-triggered scheme. When the status-triggered scheme is used, the signal is valid when it is on. When the edge-triggered scheme is used, the signal becomes valid on the rising edge when it switches from off to on status.

One of the two schemes is selected with TSE (bit 3 of parameter 6003). When the status-triggered scheme is selected by this parameter, a custom macro interrupt is generated if the interrupt signal (UINT) is on at the time the signal becomes valid. By keeping the interrupt signal (UINT) on, the interrupt program can be executed repeatedly.

When the edge-triggered scheme is selected, the interrupt signal (UINT) becomes valid only on its rising edge. Therefore, the interrupt program is executed only momentarily (in cases when the program consists of only macro statements). When the status-triggered scheme is inappropriate, or when a custom macro interrupt is to be performed just once for the entire program (in this case, the interrupt signal may be kept on), the edge-triggered scheme is useful.

Except for the specific applications mentioned above, use of either scheme results in the same effects. The time from signal input until a custom macro interrupt is executed does not vary between the two schemes.



In the above example, an interrupt is executed four times when the status-triggered scheme is used; when the edge-triggered scheme is used, the interrupt is executed just once.

NOTE

When an M99 block consists only of address O, N, P, L, or M, this block is regarded as belonging to the previous block in the program. Therefore, a single-block stop does not occur for this block. In terms of programming, the following ① and ② are basically the same. (The difference is whether G○○ is executed before M99 is recognized.)

① G○○ X○○○ ;
M99 ;

② G○○ X○○○ M99 ;

- **Custom macro interrupt and modal information**

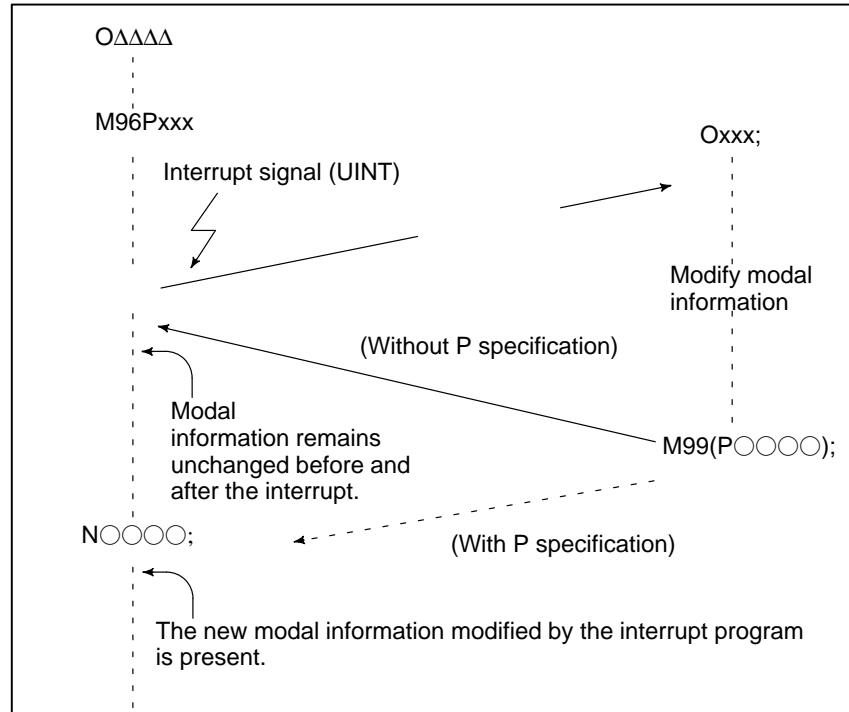
A custom macro interrupt is different from a normal program call. It is initiated by an interrupt signal (UINT) during program execution. In general, any modifications of modal information made by the interrupt program should not affect the interrupted program.

For this reason, even when modal information is modified by the interrupt program, the modal information before the interrupt is restored when control is returned to the interrupted program by M99.

When control is returned from the interrupt program to the interrupted program by M99 Pxxxx, modal information can again be controlled by the program. In this case, the new continuous information modified by the interrupt program is passed to the interrupted program. Restoration of the old modal information present before the interrupt is not desirable. This is because after control is returned, some programs may operate differently depending on the modal information present before the interrupt. In this case, the following measures are applicable:

- (1) The interrupt program provides modal information to be used after control is returned to the interrupted program.

(2) After control is returned to the interrupted program, modal information is specified again as necessary.



Modal information when control is returned by M99

Modal information when control is returned by M99 P○○○○

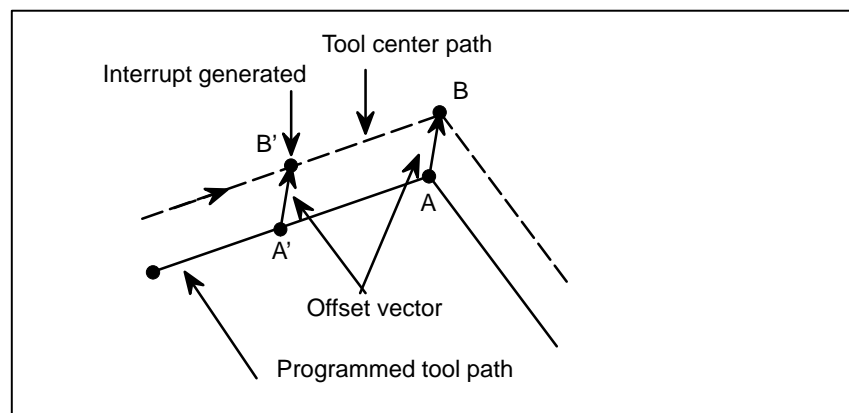
• **System variables (position information values) for the interrupt program**

The modal information present before the interrupt becomes valid. The new modal information modified by the interrupt program is made invalid.

The new modal information modified by the interrupt program remains valid even after control is returned. The old modal information which was valid in the interrupted block can be read using custom macro system variables #4001 to #4120.

Note that when modal information is modified by the interrupt program, system variables #4001 to #4120 are not changed.

- The coordinates of point A can be read using system variables #5001 and up until the first NC statement is encountered.
- The coordinates of point A' can be read after an NC statement with no move specifications appears.
- The machine coordinates and workpiece coordinates of point B' can be read using system variables #5021 and up and #5041 and up.



- **Custom macro interrupt and custom macro modal call**

When the interrupt signal (UINT) is input and an interrupt program is called, the custom macro modal call is canceled (G67). However, when G66 is specified in the interrupt program, the custom macro modal call becomes valid. When control is returned from the interrupt program by M99, the modal call is restored to the state it was in before the interrupt was generated. When control is returned by M99Pxxxx;, the modal call in the interrupt program remains valid.

- **Custom macro interrupt and program restart**

When the interrupt signal (UINT) is input while a return operation is being performed in the dry run mode after the search operation for program restart, the interrupt program is called after restart operation terminates for all axes. This means that interrupt type II is used regardless of the parameter setting.

16 PATTERN DATA INPUT FUNCTION

This function enables users to perform programming simply by extracting numeric data (pattern data) from a drawing and specifying the numerical values from the MDI panel.

This eliminates the need for programming using an existing NC language.

With the aid of this function, a machine tool builder can prepare the program of a hole machining cycle (such as a boring cycle or tapping cycle) using the custom macro function, and can store it into the program memory.

This cycle is assigned pattern names, such as BOR1, TAP3, and DRL2.

An operator can select a pattern from the menu of pattern names displayed on the screen.

Data (pattern data) which is to be specified by the operator should be created in advance with variables in a drilling cycle.

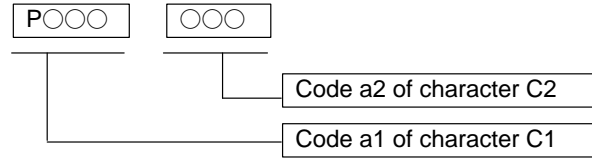
The operator can identify these variables using names such as DEPTH, RETURN RELIEF, FEED, MATERIAL or other pattern data names. The operator assigns values (pattern data) to these names.

● **Macro commands
specifying the menu
title**

Menu title : C₁ C₂ C₃ C₄ C₅ C₆ C₇ C₈ C₉ C₁₀ C₁₁ C₁₂
C₁, C₂, ..., C₁₂: Characters in the menu title (12 characters)

Macro instruction
G65 H90 P_p Q_q R_r I_i J_j K_k:
H90: Specifies the menu title

p : Assume a₁ and a₂ to be the codes of characters C₁ and C₂. Then,



q : Assume a₃ and a₄ to be the codes of characters C₃ and C₄. Then,
 $q = a_3 \cdot 10^3 + a_4$

r : Assume a₅ and a₆ to be the codes of characters C₅ and C₆. Then,
 $r = a_5 \cdot 10^3 + a_6$

i : Assume a₇ and a₈ to be the codes of characters C₇ and C₈. Then,
 $i = a_7 \cdot 10^3 + a_8$

j : Assume a₉ and a₁₀ to be the codes of characters C₉ and C₁₀. Then,
 $j = a_9 \cdot 10^3 + a_{10}$

k : Assume a₁₁ and a₁₂ to be the codes of characters C₁₁ and C₁₂. Then,
 $k = a_{11} \cdot 10^3 + a_{12}$

Example) If the title of the menu is "HOLE PATTERN" then the macro instruction is as follows:

G65 H90 P072079 Q076069 R032080
 HO LE □ P
I065084 J084069 K082078;
 AT TE RN

For codes corresponding to these characters, refer to the table in II-16.3.

- **Macro instruction describing the pattern name**

Pattern name: $C_1 C_2 C_3 C_4 C_5 C_6 C_7 C_8 C_9 C_{10}$

C_1, C_2, \dots, C_{10} : Characters in the pattern name (10 characters)

Macro instruction

G65 H91 P_n Q_q R_r I_i J_j K_k ;

H91: Specifies the menu title

n : Specifies the menu No. of the pattern name

n=1 to 10

q : Assume a_1 and a_2 to be the codes of characters C_1 and C_2 . Then,

$$q = a_1 \times 10^3 + a_2$$

r : Assume a_3 and a_4 to be the codes of characters C_3 and C_4 . Then,

$$r = a_3 \times 10^3 + a_4$$

i : Assume a_5 and a_6 to be the codes of characters C_5 and C_6 . Then,

$$i = a_5 \times 10^3 + a_6$$

j : Assume a_7 and a_8 to be the codes of characters C_7 and C_8 . Then,

$$j = a_7 \times 10^3 + a_8$$

k : Assume a_9 and a_{10} to be the codes of characters C_9 and C_{10} . Then,

$$k = a_9 \times 10^3 + a_{10}$$

Example) If the pattern name of menu No. 1 is "BOLT HOLE" then the macro instruction is as follows.

G65 H91 P1 Q066079 R076084 I032072 J079076 K069032 ;
 BO LT ┌ H OL E┐

- **Pattern No. selection**

To select a pattern from the pattern menu screen, enter the corresponding pattern No. The following is an example.



The selected pattern No. is assigned to system variable #5900. The custom macro of the selected pattern can be started by starting a fixed program (external program No. search) with an external signal then referring to the system variable #5900 in the program.

NOTE

If each characters of P, Q, R, I, J, and K are not specified in a macro instruction, two spaces are assigned to each omitted character.

Example

Custom macros for the menu title and hole pattern names.

```

MENU : HOLE PATTERN                O0000 N00000
  1.  TAPPING
  2.  DRILLING
  3.  BORING
  4.  POCKET
  5.  BOLT HOLE
  6.  LINE ANGLE
  7.  GRID
  8.  PECK
  9.  TEST PATRN
 10.  BACK

> _
MDI **** * 16:05:59
[ MACRO ] [ MENU ] [ OPR ] [ ] [ (OPRT) ]
    
```

```

O9500 ;
N1G65 H90 P072 079 Q076 069 R032 080 I 065 084 J 084 069 K082 078 ; HOLE PATTERN
N2G65 H91 P1 Q066 079 R076 084 I 032 072 J 079 076 K069 032 ; 1.BOLT HOLE
N3G65 H91 P2 Q071 082 R073 068 ; 2.GRID
N4G65 H91 P3 Q076 073 R078 069 I 032 065 J 078071 K076069 ; 3.LINE ANGLE
N5G65 H91 P4 Q084 065 R080 080 I 073 078 J 071 032 ; 4.TAPPING
N6G65 H91 P5 Q068 082 R073 076 I 076 073 J 078 071 ; 5.DRILLING
N7G65 H91 P6 Q066079 R082073 I 078 071 ; 6.BORING
N8G65 H91 P7 Q080 079 R067 075 I 069 084 ; 7.POCKET
N9G65 H91 P8 Q080069 R067075 ; 8.PECK
N10G65 H91 P9 Q084 069 R083 084 I032 080 J065 084 K082 078 ; 9.TEST PATRN
N11G65 H91 P10 Q066 065 R067 0750 ; 10.BACK
N12M99 ;
    
```

16.2 PATTERN DATA DISPLAY

When a pattern menu is selected, the necessary pattern data is displayed.

```

VAR. : BOLT HOLE                00001 N00000
NO.  NAME DATA  COMMENT
500 TOOL
501 STANDARD X 0.000 *BOLT HOLE
502 STANDARD Y 0.000 CIRCLE*
503 RADIUS 0.000 SET PATTERN
504 S. ANGL 0.000 DATA TO VAR.
505 HOLES NO0.000 NO.500-505.
506 0.000
507 0.000

ACTUAL POSITION (RELATIVE)
X 0.000 Y 0.000
Z 0.000
> _
MDI **** * 16:05:59
[ MACRO ] [ MENU ] [ OPR ] [ ] [(OPRT)]

```

BOLT HOLE : This is the pattern data title. A character string consisting of up to 12 characters can be set.

TOOL : This is the variable name. A character string consisting of up to 10 characters can be set.

BOLT HOLE CIRCLE :
This is a comment statement. A character string can be displayed consisting of up to 8 lines, 12 characters per line.

(It is permissible to use katakana in a character string or line.)

The machine tool builder should program the character strings of pattern data title, pattern name, and variable name using the custom macro, and load them into the program memory as a subprogram whose No. is 9500 plus the pattern No. (O9501 to O9510).

**Macro instruction
specifying the pattern
data title
(the menu title)**

Menu title : C₁ C₂ C₃ C₄ C₅ C₆ C₇ C₈ C₉C₁₀C₁₁C₁₂
 C₁, C₂, ..., C₁₂: Characters in the menu title (12 characters)
 Macro instruction
 G65 H92 P_n Q_q R_r I_i J_j K_k;
 H92 : Specifies the pattern name
 p : Assume a₁ and a₂ to be the codes of characters C₁ and C₂. Then,

$$p = a_1 \times 10^3 + a_2$$
 See 17.3 for character codes.
 q : Assume a₃ and a₄ to be the codes of characters C₃ and C₄. Then,

$$q = a_3 \times 10^3 + a_4$$

 r : Assume a₅ and a₆ to be the codes of characters C₅ and C₆. Then,

$$r = a_5 \times 10^3 + a_6$$

 i : Assume a₇ and a₈ to be the codes of characters C₇ and C₈. Then,

$$i = a_7 \times 10^3 + a_8$$

 j : Assume a₉ and a₁₀ to be the codes of characters C₉ and C₁₀. Then,

$$j = a_9 \times 10^3 + a_{10}$$

 k : Assume a₁₁ and a₁₂ to be the codes of characters C₁₁ and C₁₂. Then,

$$k = a_{11} \times 10^3 + a_{12}$$

 Example) Assume that the pattern data title is "BOLT HOLE." The macro instruction is given as follows:

```
G65 H92 P066079 Q076084 R032072 I079076 J069032;
          BO      LT      □ H      OL      E
```

**● Macro instruction
specifying the variable
name**

Variable name : C₁ C₂ C₃ C₄ C₅ C₆ C₇ C₈ C₉C₁₀
 C₁, C₂, ..., C₁₀: Characters in the variable name (10 characters)
 Macro instruction
 G65 H93 P_n Q_q R_r I_i J_j K_k;
 H93 : Specifies the variable name
 n : Specifies the menu No. of the variable name
 n=1 to 10
 q : Assume a₁ and a₂ to be the codes of characters C₁ and C₂. Then,

$$q = a_1 \times 10^3 + a_2$$

 r : Assume a₃ and a₄ to be the codes of characters C₃ and C₄. Then,

$$r = a_3 \times 10^3 + a_4$$

 i : Assume a₅ and a₆ to be the codes of characters C₅ and C₆. Then,

$$i = a_5 \times 10^3 + a_6$$

 j : Assume a₇ and a₈ to be the codes of characters C₇ and C₈. Then,

$$j = a_7 \times 10^3 + a_8$$

 k : Assume a₉ and a₁₀ to be the codes of characters C₉ and C₁₀. Then,

$$k = a_9 \times 10^3 + a_{10}$$

 Example) Assume that the variable name of the variable No. 503 is "RADIUS." The macro instruction is given as follows:

```
G65 H93 P503 Q082065 R068073 I085083 ;
RADI US
```

NOTE

Variable names can be assigned to 32 common variables #500 to #531, which are not cleared when the power is turned off.

- **Macro instruction to describe a comment**

One comment line: $C_1 C_2 C_3 C_4 C_5 C_6 C_7 C_8 C_9 C_{10} C_{11} C_{12}$

C_1, C_2, \dots, C_{12} : Character string in one comment line (12 characters)

Macro instruction

G65 H94 P_n Q_q R_r I_i J_j K_k ;

H94 : Specifies the comment

p : Assume a_1 and a_2 to be the codes of characters C_1 and C_2 . Then,

$$p = a_1 \times 10^3 + a_2$$

See 17.7 for character codes.

q : Assume a_3 and a_4 to be the codes of characters C_3 and C_4 . Then,

$$q = a_3 \times 10^3 + a_4$$

r : Assume a_5 and a_6 to be the codes of characters C_5 and C_6 . Then,

$$r = a_5 \times 10^3 + a_6$$

i : Assume a_7 and a_8 to be the codes of characters C_7 and C_8 . Then,

$$i = a_7 \times 10^3 + a_8$$

j : Assume a_9 and a_{10} to be the codes of characters C_9 and C_{10} . Then,

$$j = a_9 \times 10^3 + a_{10}$$

k : Assume a_{11} and a_{12} to be the codes of characters C_{11} and C_{12} . Then,

$$k = a_{11} \times 10^3 + a_{12}$$

A comment can be displayed in up to eight lines. The comment consists of the first line to the eighth line in the programmed sequence of G65 H94 for each line.

Example) Assume that the comment is "BOLT HOLE." The macro instruction is given as follows:

```
G65 H94 P042066 Q079076 R084032 I072079 J076069;
          *B      OL      T  HO      LE
```

Examples

Macro instruction to describe a parameter title , the variable name, and a comment.

```

VAR. : BOLT HOLE                O0001 N00000
NO.  NAME DATA  COMMENT
500 TOOL
501 STANDARD X 0.000 *BOLT HOLE
502 STANDARD Y 0.000 CIRCLE*
503 RADIUS 0.000 SET PATTERN
504 S. ANGL 0.000 DATA TO VAR.
505 HOLES NO0.000 NO.500-505.
506 0.000
507 0.000

ACTUAL POSITION (RELATIVE)
X 0.000 Y 0.000
Z 0.000
> _
MDI **** ** 16:05:59
[ MACRO ] [ MENU ] [ OPR ] [ ] [(OPRT)]
    
```

```

O9501 ;
N1G65 H92 P066 079 Q076 084 R032 072 I 079 076 J069 032 ; VAR : BOLT HOLE
N2G65 H93 P500 Q084 079 R079076 ; #500 TOOL
N3G65 H93 P501 Q075 073 R074 085 I078 032 J088 032 ; #501 KIJUN X
N4G65 H93 P502 Q075 073 R074 085 I 078 032 J089 032 ; #502 KIJUN Y
N5G65 H93 P503 Q082 065 R068 073 I 085 083 ; #503 RADIUS
N6G65 H93 P504 Q083 046 R032 065 I 078 071 J 076 032 ; #504 S.ANGL
N7G65 H93 P505 Q072 079 R076 069 I 083 032 J078 079 K046 032 ; #505 HOLES NO
N8G65 H94 ; Comment
N9G65 H94 P042 066 Q079 076 R084 032 I072 079 J076 069 ; *BOLT HOLE
N10G65 H94 R032 067 I073 082 J067 076 K069 042 ; CIRCLE*
N11G65 H94 P083 069 Q084 032 080 065 I084 084 J069 082 K078 032 ; SET PATTERN
N12G65 H94 P068 065 Q084 065 R032 084 I079 032 J086 065 K082046 ;DATA NO VAR.
N13G65 H94 P078 079 Q046 053 R048 048 I045 053 J048 053 K046 032;No.500-505
N14M99 ;
    
```

16.3 CHARACTERS AND CODES TO BE USED FOR THE PATTERN DATA INPUT FUNCTION

Table.16.3(a) Characters and codes to be used for the pattern data input function

Character	Code	Comment	Character	Code	Comment
A	065		6	054	
B	066		7	055	
C	067		8	056	
D	068		9	057	
E	069			032	Space
F	070		!	033	Exclamation mark
G	071		"	034	Quotation mark
H	072		#	035	Hash sign
I	073		\$	036	Dollar sign
J	074		%	037	Percent
K	075		&	038	Ampersand
L	076		'	039	Apostrophe
M	077		(040	Left parenthesis
N	078)	041	Right parenthesis
O	079		*	042	Asterisk
P	080		+	043	Plus sign
Q	081		,	044	Comma
R	082		-	045	Minus sign
S	083		.	046	Period
T	084		/	047	Slash
U	085		:	058	Colon
V	086		;	059	Semicolon
W	087		<	060	Left angle bracket
X	088		=	061	Equal sign
Y	089		>	062	Right angle bracket
Z	090		?	063	Question mark
0	048		@	064	HA™mark
1	049		[091	Left square bracket
2	050		^	092	
3	051		¥	093	Yen sign
4	052]	094	Right square bracket
5	053		_	095	Underscore

NOTE

Right and left parentheses cannot be used.

Table 16.3 (b)Numbers of subprograms employed in the pattern data input function

Subprogram No.	Function
O9500	Specifies character strings displayed on the pattern data menu.
O9501	Specifies a character string of the pattern data corresponding to pattern No.1
O9502	Specifies a character string of the pattern data corresponding to pattern No.2
O9503	Specifies a character string of the pattern data corresponding to pattern No.3
O9504	Specifies a character string of the pattern data corresponding to pattern No.4
O9505	Specifies a character string of the pattern data corresponding to pattern No.5
O9506	Specifies a character string of the pattern data corresponding to pattern No.6
O9507	Specifies a character string of the pattern data corresponding to pattern No.7
O9508	Specifies a character string of the pattern data corresponding to pattern No.8
O9509	Specifies a character string of the pattern data corresponding to pattern No.9
O9510	Specifies a character string of the pattern data corresponding to pattern No.10

Table. 16.3 (c)Macro instructions used in the pattern data input function

G code	H code	Function
G65	H90	Specifies the menu title.
G65	H91	Specifies the pattern name.
G65	H92	Specifies the pattern data title.
G65	G93	Specifies the variable name.
G65	H94	Specifies the comment.

Table. 16.3 (d)System variables employed in the pattern data input function

System variable	Function
#5900	Pattern No. selected by user.

17 PROGRAMMABLE PARAMETER ENTRY (G10)

General

The values of parameters can be entered in a lprogram. This function is used for setting pitch error compensation data when attachments are changed or the maximum cutting feedrate or cutting time constants are changed to meet changing machining conditions.

Format

Format
G10L50 ; Parameter entry mode setting N_R_ ; For parameters other than the axis type N_P_R_ ; For axis type parameters : : : G11 ; Parameter entry mode cancel
Meaning of command
N_ : Parameter No. (4digids) or compensation position No. for pitch errors compensation +10,000 (5digid) R_ : Parameter setting value (Leading zeros can be omitted.) P_ : Axis No. 1 to 8 (Used for entering axis type parameters)

Explanations

- **Parameter setting value (R_)**
- **Axis No.(P_)**

Do not use a decimal point in a value set in a parameter (R_).
a decimal point cannot be used in a custom macro variable for R_ either.

Specify an axis number (P_) from 1 to 8 (up to eight axes) for an axis type parameter. The control axes are numbered in the order in which they are displayed on theCNC display.

For example, specify P2 for the control axis which is displayed second.

WARNING

- 1 Do not fail to perform reference point return manually after changing the pitch error compensation data or backlash compensation data. Without this, the machine position can deviate from the correct position.
- 2 The canned-cycle mode must be cancelled before entering of parameters. When not cancelled, the drilling motion may be activated.

NOTE

Other NC statements cannot be specified while in parameter input mode.

Examples

1. Set bit 2 (SBP) of bit type parameter No. 3404

G10L50 ;	Parameter entry mode
N3404 R 00000100 ;	SBP setting
G11 ;	cancel parameter entry mode

2. Change the values for the Z-axis (3rd axis) and A-axis (4th axis) in axis type parameter No. 1322 (the coordinates of stored stroke limit 2 in the positive direction for each axis).

G10L50 ;	Parameter entry mode
N1322P3R4500 ;	Modify Z axis
N1322P4R12000 ;	Modify A axis
G11 ;	cancel parameter entry mode

18 MEMORY OPERATION USING FS15 TAPE FORMAT

General

Memory operation of the program registered by FS15 tape format is possible with setting of the setting parameter (No. 0001#1).

Explanations

Data formats for cutter compensation, subprogram calling, and canned cycles are different between the Series 16/18 and Series 15. The Series 15 data formats can be processed for memory operation. Other data formats must comply with the Series 16/18. When a value out of the specified range for the Series 16/18 is registered, an alarm occurs. Functions not available in the Series 16/18 cannot be registered or used for memory operation.

- **Address for the cutter compensation offset number**

Offset numbers are specified by address D in the Series 15. When an offset number is specified by address D, the modal value specified by address H is replaced with the offset number specified by address D.

- **Subprogram call**

If a subprogram number of more than four digits is specified, the four low-order digits are regarded as the subprogram number. If no repeat count is specified, 1 is assumed.

Table18(a) Subprogram call data format

CNC	Data format
Series 15	M98 P ○○○○○○ L ○○○○ ; P : Subprogram number L : Repetition count
Series 16/18	M98 P ○○○○ □□□□ ; Repetition count Subprogram number

- **Address for the canned cycle repetition count**

The Series 15 and Series 16/18 use different addresses for the repeat count for canned cycles as listed in Table 19 (b).

Table18(b) Address for times of repetition of canned cycle

CNC	Address
Series 15	L
Series 16/18	K

19 HIGH SPEED CUTTING FUNCTIONS



19.1 HIGH-SPEED CYCLE CUTTING

General

This function can convert the machining profile to a data group that can be distributed as pulses at high-speed by the macro compiler and macro executor. The function can also call and execute the data group as a machining cycle using the CNC command (G05 command).

Format

G05 P10○○○ L○○○ ;

P10○○○ is number of the machining cycle to be called first:
P10001 to P10999
L○○○ is repetition count of the machining cycle
(L1 applies when this parameter is omitted.) :
L1 to L999

Call and execute the data for the high speed cutting cycle specified by the macro compiler and macro executor using the above command.

Cycle data can be prepared for up to 999 cycles. Select the machining cycle by address P. More than one cycle can be called and executed in series using the cycle connection data in the header.

Specify the repetition count of the called machining cycle by address L. The repetition count in the header can be specified for each cycle.

The connection of cycles and their repetition count are explained below with an example.

Example) Assume the following:

Cycle 1 Cycle connection data 2 Repetition count 1

Cycle 2 Cycle connection data 3 Repetition count 3

Cycle 3 Cycle connection data 0 Repetition count 1

G05 P10001 L2 ;

The following cycles are executed in sequence:

Cycles 1, 2, 2, 2, 3, 1, 2, 2, 2, and 3

NOTE

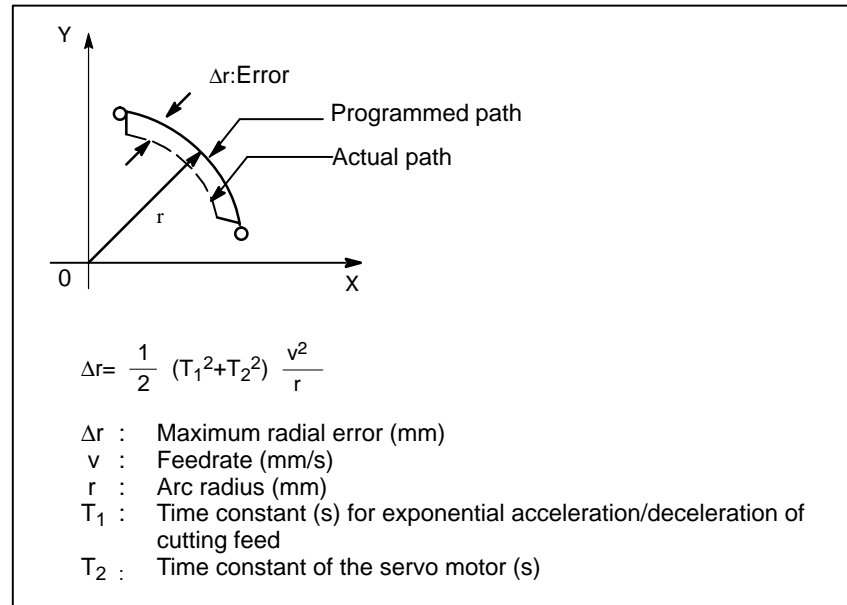
- 1 An alarm is issued if the function is executed in the G41/G42 mode.
- 2 Single block stop, dry run/feedrate override, automatic acceleration/deceleration and handle interruption are disabled during high-speed cycle machining.

Alarms

Alarm number	Descriptions
115	<p>The contents of the header are invalid. This alarm is issued in the following cases.</p> <ol style="list-style-type: none">1. The header corresponding to the number of the specified call machining cycle was not found.2. A cycle connection data value is not in the valid range (0 to 999).3. The number of data items in the header is not in the valid range (1 to 32767).4. The first variable No. for storing data in the executable format is not in the valid range (#20000 to #85535).5. The last variable No. for storing data in the executable format exceeds the limit (#85535).6. The first variable No. for start data in the executable format overlaps with a variable No. used in the header.
178	High-speed cycle machining was specified in the G41/G42 mode.
179	The number of control axes specified in parameter 7510 exceeds the maximum number.

19.2 FEEDRATE CLAMPING BY ARC RADIUS

When an arc is cut at a high speed in circular interpolation, a radial error exists between the actual tool path and the programmed arc. An approximation of this error can be obtained from the following expression:



When actual machining is performed, radius r of the arc to be machined and permissible error Δr are given. Then, maximum allowable feedrate v (mm/min) is determined from the above expression.

The function for clamping the feedrate by the arc radius automatically clamps the feedrate of arc cutting to the value set in a parameter. This function is effective when the specified feedrate may cause the radial error for an arc with a programmed radius to exceed the permissible degree of error.

For details, refer to the relevant manual published by the machine tool builder.

19.3 LOOK-AHEAD CONTROL (G08)

This function is designed for high-speed precise machining. With this function, the delay due to acceleration/deceleration and the delay in the servo system which increase as the feedrate becomes higher can be suppressed.

The tool can then follow specified values accurately and errors in the machining profile can be reduced.

This function becomes effective when look-ahead control mode is entered.

For details, refer to the relevant manual published by the machine tool builder.

Format

G08 P_

P1 : Turn on look-ahead control mode.

P0 : Turn off look-ahead control mode.

Explanations

- **Available functions**

In look-ahead control mode, the following functions are available:

(1) Linear acceleration/deceleration before interpolation

(2) Automatic corner deceleration function

For details on the above functions, see the descriptions of the functions.

Each function, specific parameters are provided.

- **Reset**

Look-ahead control mode is canceled by reset.

Limitations

- **G08 command**

Specify G08 code only in a block.

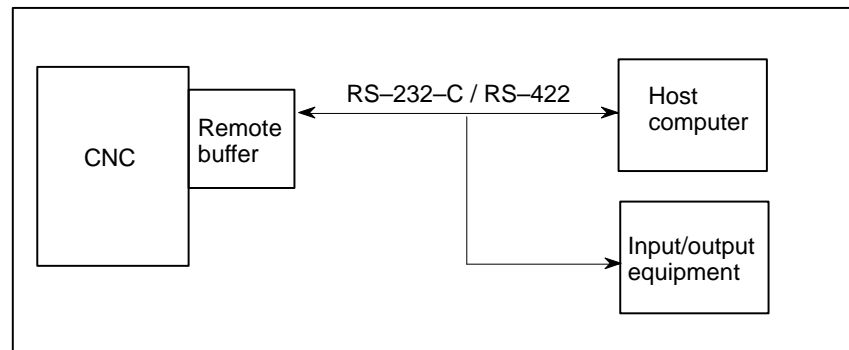
- **Functions that cannot be specified**

In the look-ahead control mode, the functions listed below cannot be specified. To specify these functions, cancel the look-ahead control mode, specify the desired function, then set look-ahead control mode again.

- Rigid tapping function
- Cs contour axis control function
- Feed per rotation
- Feed at address F with one digit
- C-axis normal direction control function
- Polar coordinate interpolation function
- Cylindrical interpolation function
- Involute interpolation function
- Exponential interpolation
- Three-dimensional coordinate conversion
- Retrace function
- Normal direction control
- Polar coordinate command
- Index table indexing
- Tool withdrawal and return
- Threading and synchronous feed
- High-speed cycle machining
- Handle interrupt
- Program restart
- Simplified synchronization control
- Feed stop
- High-speed skip function
- Constant surface speed control
- Interrupt type custom macro
- Small-diameter peck drilling cycle
- High-speed remote buffer A/B
- Automatic tool length measurement
- Skip cutting
- G28 (low-speed reference position return)

19.4 HIGH-SPEED REMOTE BUFFER

A remote buffer can continuously supply a large amount of data to the CNC at high speeds when connected to the host computer or input/output equipment via a serial interface.

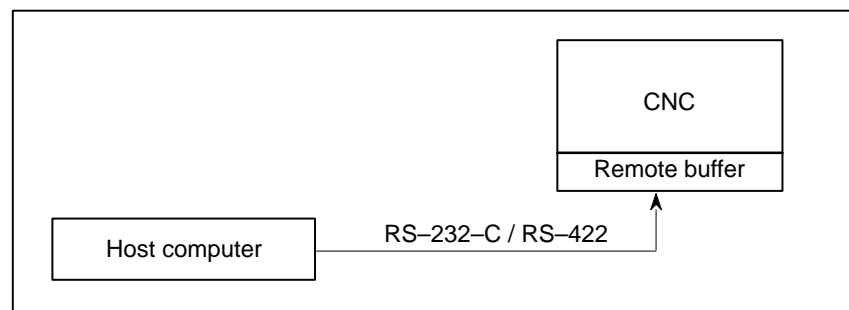


When the remote buffer is connected online to the host computer, fast and reliable DNC operation is possible.

The remote buffer function includes high-speed remote buffer A and high-speed remote buffer B for high-speed machining. High-speed remote buffer A uses binary data. High-speed remote buffer B uses NC language. For details on remote buffer specifications, refer to the “Remote Buffer Supplement” (B-61802E-1).

19.4.1 High-speed remote buffer A (G05)

Specify G05 only in a block using normal NC command format. Then specify move data in the special format explained below. When zero is specified as the travel distance along all axes, normal NC command format can be used again for subsequent command specification.



Format

VBinary input operation enabled : G05;
VBinary input operation disabled: The travel distance along all axes are set to zero.

VData format for binary input operation

In the data format for binary input operation, the travel distance along each axis (2 bytes) per unit time is specified. The travel distances along all axes are placed sequentially from the first axis, then a check byte is added. (The data length for one block is [2 x N + 1] bytes). All data must be specified in binary.

Explanations

- **Selecting the unit time**
- **Travel distance data**

The unit time (in ms) can be selected by setting bits 4, 5, and 6 of parameter IT0,IT1,IT2 No. 7501.

The following unit is used for specifying the travel distance along each axis. (A negative travel distance is indicated in 2's complement.)

Increment system	IS-B	IS-C	Unit
Millimeter machine	0.001	0.0001	mm
Inch machine	0.0001	0.00001	inch

The data format of the travel distance is as follows. The bits marked * are used to specify a travel distance per unit time.

15	14	13	12	11	10	9	8	7	6	5	4	3	2	1	0
*	*	*	*	*	*	*	0	*	*	*	*	*	*	*	0

Example: When the travel distance is 700 μm per unit time
(millimeter machine with increment system IS-B)

15	14	13	12	11	10	9	8	7	6	5	4	3	2	1	0
0	0	0	0	1	0	1	0	0	1	1	1	1	0	0	0

- **Check Byte**

All bytes of the block except for the check byte ([2*N] bytes) are summed up, and any bits above 8th bit are discarded.

- **Transfer speed**

The CNC reads (2 x N + 1)-byte data (where N is the number of axes) for every unit time that is set in the parameter. To allow the CNC to continue machining without interruption, the following minimum baud rate is required for data transfer between the host and remote buffer:

$$(2 \times N + 1) \times \frac{11}{T} \times 1000 \text{ baud (T : Unit time)}$$

- **Cutter compensation**

If G05 is specified in cutter compensation mode, the P/S 178 alarm is issued.

- **Feed hold and interlock**

Feed hold and interlock are effective.

- **Mirror image**

The mirror image function (programmable mirror image and setting mirror image) cannot be turned on or off in the G05 mode.

- **Acceleration / deceleration type**

In binary input operation mode, when tool movement starts and stops in cutting feed mode, exponential acceleration/deceleration is performed (the acceleration/deceleration time constant set in parameter No. 1622 is used).

Limitations

- **Modal command**

In binary input operation mode, only linear interpolation as specified in the defined data format is executed (equivalent to the incremental command for linear interpolation).

- **Invalid functions**

The single block, feedrate override, and maximum cutting feedrate clamp functions have no effect. The program restart, block restart, and high-speed machining functions cannot be used. In addition, miscellaneous functions cannot be executed in binary operation.

- **Memory registration**

No data can be stored in memory.

19.4.2 High-speed remote buffer B (G05)

High-speed remote buffer A uses binary data. On the other hand, high-speed remote buffer B can directly use NC language coded with equipment such as an automatic programming unit to perform high-speed machining.

Format

```
G05P01 ; Start high-speed machining
G05P00 ; End high-speed machining
```

```
Example : O1234 ;
          ⋮
          G05P01 ; ← Start high-speed machining
          X_ Y_ Z_ ;
          ⋮
          G05P00 ; ← End high-speed machining
          ⋮
          M02 ;
```

Explanations

- Specified data

The following data can be specified during high-speed machining:

Address	Data
X	Travel distance along the X-axis
Y	Travel distance along the Y-axis
Z	Travel distance along the Z-axis
F	Cutting feedrate

Data other than the above cannot be specified.

- Number of controlled axes

Be sure to set 3 in parameter No. 7510 as the number of controlled axes.

Limitations

- Incremental command

Move commands can be specified only in incremental mode.

- Functions that cannot be specified

Cutter compensation B and C cannot be specified. The feedrate cannot be overridden.

- Feedrate clamp

The maximum cutting feedrate clamp function is disabled.

- Binary data format

The format of high-speed remote buffer A can also be used for high-speed remote buffer B. This format, however, cannot be used together with NC language within the same program.

19.5 HIGH-PRECISION CONTOUR CONTROL

Some machining errors are due to the CNC. Such errors include machining errors caused by acceleration/deceleration after interpolation. To eliminate these errors, the following functions are performed at high speed by a RISC processor. These functions are called high-precision contour control functions.

- (1) Function for multiple-block look-ahead acceleration/deceleration before interpolation. This function eliminates machining errors due to acceleration/deceleration.
- (2) Automatic speed control function which enables smooth acceleration/deceleration by considering changes in the figure and speed and allowable acceleration for the machine. This is performed by reading multiple blocks in advance.

For details on high-precision contour control using RISC, refer to the relevant manual published by the machine tool builder.

Format

G05P10000 ;	Start HPCC mode
G05P0 ;	End HPCC mode

Explanations

- **HPCC mode**

The mode used to perform high-precision contour control using RISC is called HPCC mode.

To start the HPCC mode in a certain block, specify G05P10000 before that block. To end the HPCC mode, specify G05P0 at the point at which to end the mode.

- **Data that can be specified**

The following data can be specified in HPCC mode:

G00 : Positioning (Note)
 G01 : Linear interpolation
 G02 : Circular interpolation (CW)
 G03 : Circular interpolation (CCW)
 G17 : Plane selection (XpYp plane)
 where, Xp is the X-axis or a parallel axis;
 G18 : Plane selection (ZpXp plane)
 where, Yp is the Y-axis or a parallel axis;
 G19 : Plane selection (YpZp plane)
 where, Zp is the Z-axis or a parallel axis.
 G38 : Cutter compensation C with vector held
 G40 : Cutter compensation cancel
 G41 : Cutter compensation, left
 G42 : Cutter compensation, right
 G90 : Absolute command
 G91 : Incremental command
 Dxxx : Specifying a D code
 Fxxxx : Specifying an F code
 Nxxxx : Specifying a sequence number
 G05P10000 : Setting the HPCC mode
 G05P0 : Canceling the HPCC mode

I, J, K, R : I, J, K, and R specified for circular interpolation
 Data for movement along axis : Data for moving the tool along the axis set in parameter No. 1020 (any axis selected from X, Y, Z, U, V, W, A, B, and C)

() : Control-in and control-out commands
 (comment specification)

/n : Optional block skip command (n is a number.)

Mxxxx : Auxiliary function (Note)

Sxxxx : Auxiliary function (Note)

Txxxx : Auxiliary function (Note)

Bxxxx : Auxiliary function (Note)

M98, M198, etc. : Subprogram call

NOTE

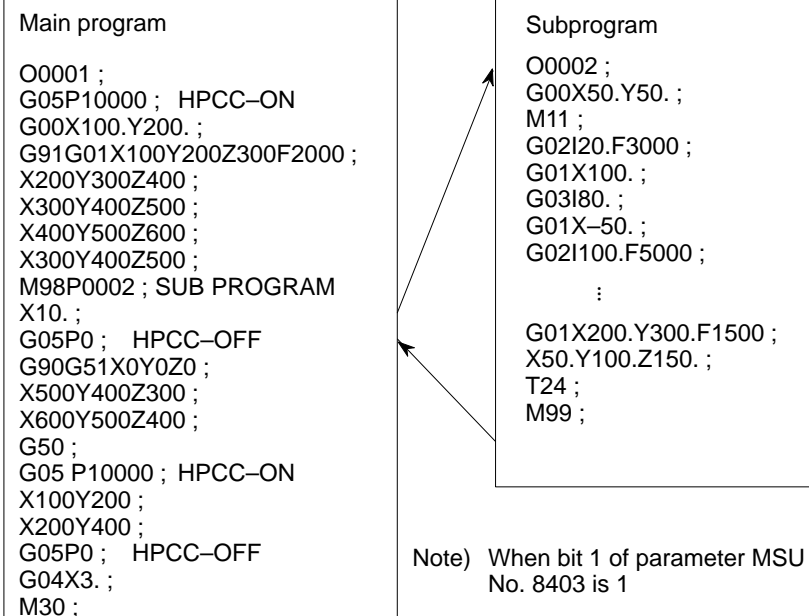
- 1 G00, auxiliary functions, subprogram call (M98, M198), and macro call M and T codes can be specified in the HPCC mode only when bit 1 of parameter MSU No. 8403 is 1. If these codes are specified when MSU is not 1, an alarm is issued.
- 2 To specify the following functions in HPCC mode, the following parameters are required. Specifying any of the following functions without setting the corresponding parameter causes an alarm.

Helical interpolation	: Parameter G02 (No.8485*)
Involute interpolation	: Parameter INV (No. 8485)
Scaling, coordinate rotation	: Parameter G51 (No. 8485)
Canned cycle, rigid tapping	: Parameter G81 (No.8485)

- **When unspecifiable data is specified**

In the HPCC mode, specifying unspecifiable data causes an alarm. To specify a program containing unspecifiable data, specify G05P0 to exit from the HPCC mode before specifying the program.

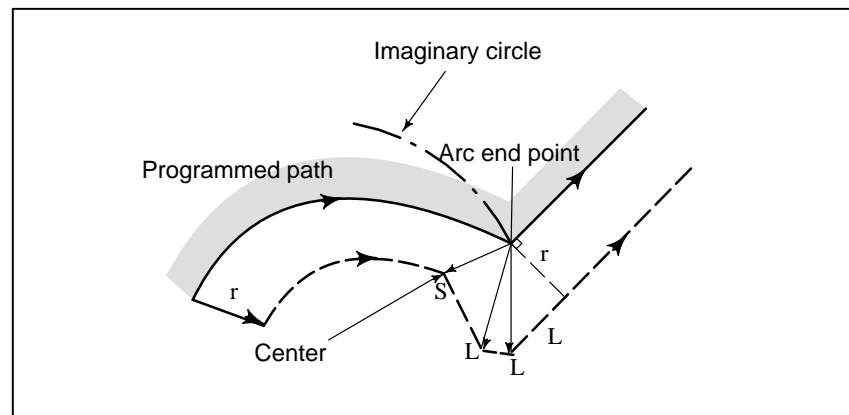
< Sample program >



• Cutter compensation C

When the cutter compensation C option is provided, cutter compensation C is enabled even in HPCC mode. Operation in the offset mode is the same as when HPCC mode is not set, except in the following cases:

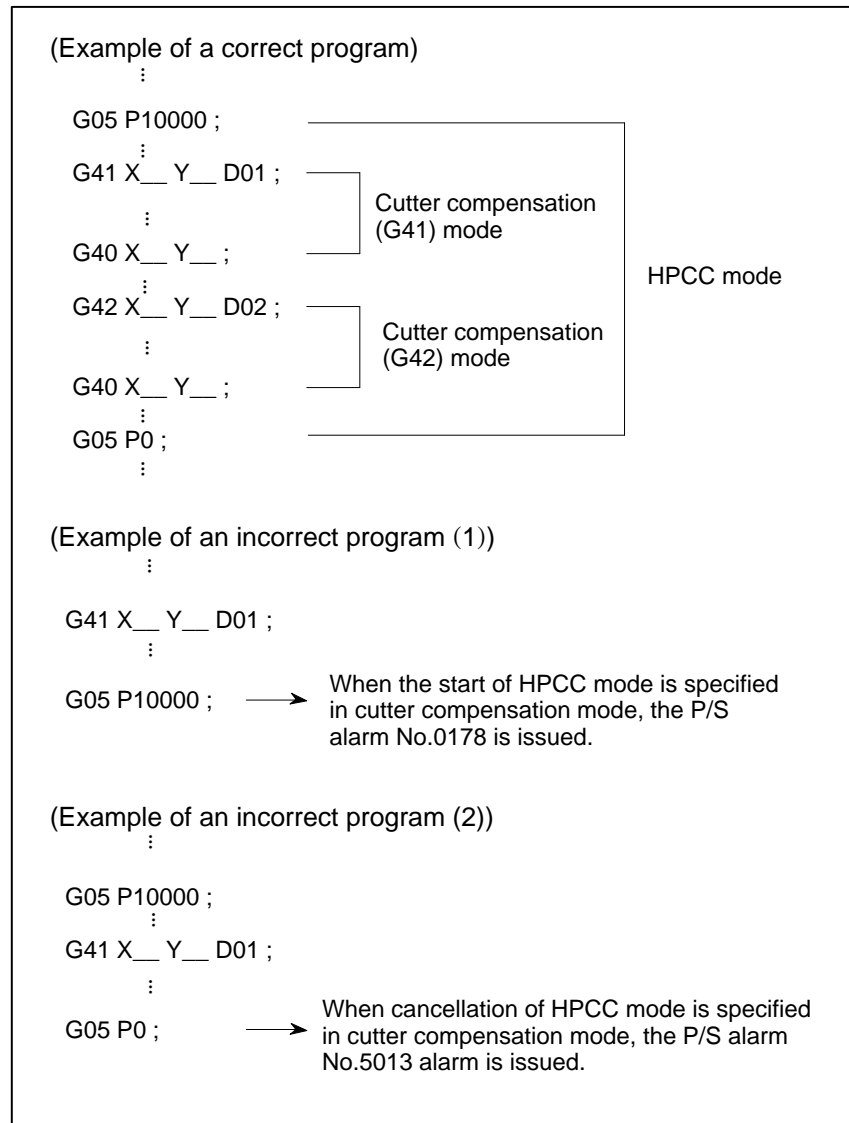
- When the end point for an arc does not lie on the arc
In the HPCC mode, when the end point for an arc does not lie on the arc, the start point and end point are connected with a smooth curve; no arc leading line is created. In this case, the system assumes an imaginary circle to perform cutter compensation C. The center of the imaginary circle is the same as the center of the arc, but the imaginary circle passes through the end point. Under the assumption that cutter compensation has been performed with respect to the imaginary circle, the system creates a vector and performs compensation.



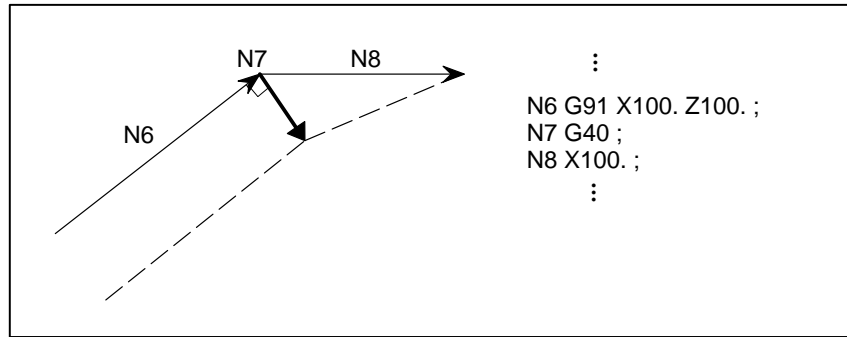
- When the offset mode is canceled temporarily
In the HPCC mode, automatic reference position return (G28) and automatic return from the reference position (G29) cannot be specified. Therefore, commands that must cancel the offset mode temporarily cannot be specified.

When using cutter compensation C in the HPCC mode, note the following points:

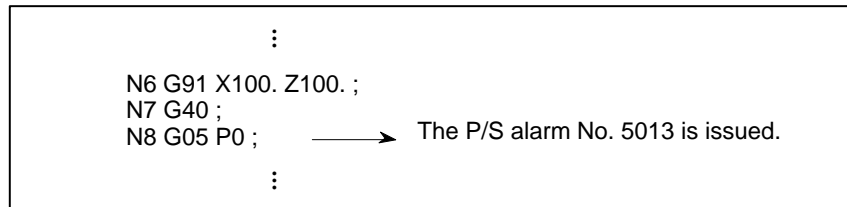
- (1) When G05 P10000 and G05 P0, and G41/G42 and G40 are to be specified together, G41/G42 to G40 must be nested between G05 P10000 and G05 P0. This means that HPCC mode cannot be started or canceled in cutter compensation (G41/G42) mode. If such a specification is made, the P/S alarm No.0178 or P/S alarm No.5013 P/S alarm is issued.



- (2) When a block containing no movement operation is specified together with the cutter compensation cancel code (G40), a vector with a length equal to the offset value is created in a direction perpendicular to the movement direction of the previous block. Cutter compensation mode is canceled while this vector still remains. This vector is canceled when the next move command is executed.



If cutter compensation mode is canceled while a vector still remains and HPCC mode is canceled before a move command is specified, the P/S alarm No.5013 is issued.



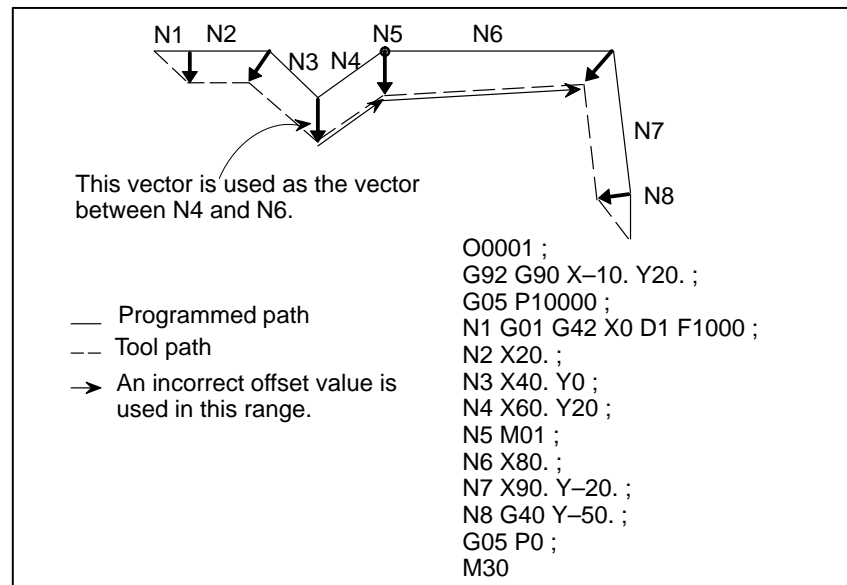
- (3) When an offset value is changed during cutter compensation C in HPCC mode, the new offset value is not used until a block specifying a D code appears.

● Positioning and auxiliary functions

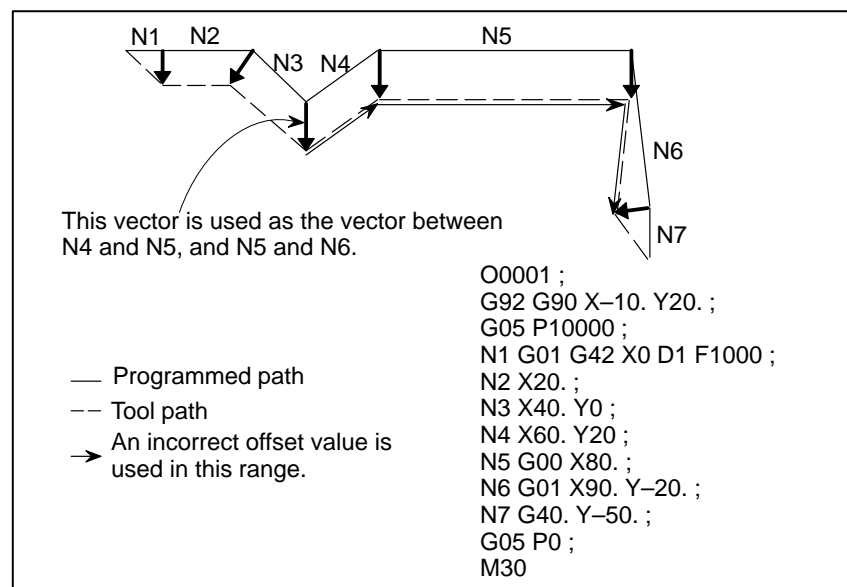
When bit 1 of parameter MSU No. 8403 is set to 1, G00, M, S, T, and B codes can be specified even in HPCC mode. When specifying these codes in HPCC mode, note the following:

(1) When a G00, M, S, T, or B code is specified in cutter compensation mode, the offset vector created in the previous block is maintained.

(Example 1) When the following program is executed for machining with offset value D1 set to 10 mm, the start point of N6 is determined by the vector created between N3 and N4:



(Example 2) When the following program is executed for machining with offset value D1 set to 10 mm, the start point of N5 is determined by the vector created between N3 and N4. If the simplified G00 execution function is enabled (by setting bit 7 of parameter SG0 No. 8403 to 1), a correct vector can be obtained at the intersection of N4 and N5.



(2) When G00 is specified with bit 7 of parameter SG0 No. 8403 set to 1, the following points should be noted:

· Since the G00 command is replaced by the G01 command, the tool moves at the feedrate set in parameter No. 8481 even when data is specified for two axes.

Example) If the following is specified when parameter No. 8481 is set to 1000 mm/min, F1000 is used instead of F1414
G00 X100. Y100. ;

- Since the G00 command is replaced by the G01 command, rapid traverse override is disabled and cutting feed override is enabled.
- For acceleration/deceleration after interpolation, the time constant used for cutting feed acceleration/deceleration after interpolation is selected.
- Linear and bell-shaped acceleration/deceleration before interpolation in HPCC mode is enabled.
- No position check is performed.
- Linear interpolation type positioning is performed.

• Status display

When G05P10000 is specified, “HPCC” starts blinking at the right-bottom of the screen. While “HPCC” is blinking, the system performs automatic operation in HPCC mode.

Display example for when the system is in HPCC mode
(Program screen)

```

PROGRAM(MEMORY)                                O1234 N00010
G05 P10000 ; -----> Executed block
N10 X10. Y10. Z10. ; -----> Block being executed
N20 X10. Y10. Z10. ;
/ N30 X10. Y10. Z10. ;
/2 N40 X10. Y10. Z10. ;
N50 X10. Y10. Z10. ;
N60 X10. Y10. Z10. ;
N70 (FANUC Series 16) ;
N80 X10. Y10. Z10. ;
N90 X10. Y10. Z10. ;
N100 X10. Y10. Z10. ;
N110 X10. Y10. Z10. ;
G05 P0 ;
MEM STRT MTN ***                                01 : 23 : 45    HPCC
( PRGRM ) (      ) (      ) ( NEXT ) ( OPRT )

```

Limitations

- **Modes that can be specified**

Before G05P10000 can be specified, the following modal values must be set. If they are not set, the P/S alarm No. 5012 is issued.

G code	Meaning
G13.1	Cancels polar coordinate interpolation.
G15	Cancels a polar coordinate command.
G40	Cancels cutter compensation (M system).
G40.1	Cancels normal direction control (for the M system only).
G50	Cancels scaling.
G50.1	Cancels the programmable mirror image function.
G64	Cutting mode
G69	Cancels coordinate conversion.
G80	Cancels canned cycles.
G94	Feed per minute
G97	Cancels constant surface speed control.
M97	Cancels interrupt type macros.

- **Single block**

The G05P10000 block cannot be executed in the single block mode.

- **Second feedrate override and optional block skip**

The second feedrate override and optional block skip functions cannot be used in HPCC mode unless these options are provided.

- **Invalid command**

Externally-requested deceleration, feed at address F with one digit, and automatic corner override commands are ignored.

- **MDI operation**

Switching to the MDI mode cannot be performed in HPCC mode. In addition, MDI operation is not possible.

- **Interlock**

Interlock (for each axis and in each direction) is disabled in HPCC mode.

- **Mirror image and machine lock**

In HPCC mode, never change the external mirror image signal (DI signal), parameter-set mirror image, and each-axis machine lock.

- **Calculator-type input**

In HPCC mode, calculator type input (when bit 0 of parameter DPI No. 3401 is 1) is ignored.

- **Program reset**

A program containing G05P10000; cannot be restarted.

- **Custom macro**

No custom macros can be specified in HPCC mode.

19.6 SIMPLE HIGH-PRECISION CONTOUR CONTROL (G05.1)

By taking full advantage of high-precision contour control using a RISC processor, this function enables high-speed high-precision machining without the need for special hardware.

The function enables look-ahead linear acceleration/deceleration before interpolation of up to 15 blocks. This results in smooth acceleration/deceleration over many blocks, as well as high-speed machining.

Format

G05.1 Q_ ;

Q1 : Start simple high-precision contour control mode

Q0 : End simple high-precision contour control mode

A block for specifying G05.1 must not contain any other command. Simple high-precision contour control mode can also be canceled by a reset.

Explanations

- **Look-ahead control**

To enable this function, the simple high-precision contour control function is necessary. When the simple high-precision contour control function is selected, the look-ahead control command (G08 P1) can be programmed.

- **Dry run**

When the dry run signal is inverted from 0 to 1 or from 1 to 0 during movement along an axis, the speed of the movement is increased or decreased to the desired speed without first being reduced to zero.

- **Deceleration stop**

When a no-movement block or a one-shot G code such as G04 is encountered in simple high-precision contour control mode, the movement is decelerated and halted in the preceding block.

- **Specifications**

Axis control

Item	Description
Controlled axes	3 to 8
Simultaneously controlled axes	Up to 6
Axis name	Basic three axes: Always X, Y, and Z Other axes: U, V, W, A, B, or C
Least input increment	0.001mm, 0.001 deg, 0.0001 inch
Input increment 1/10	0.0001mm, 0.0001 deg, 0.00001 inch

Interpolation functions

- Can be programmed
 × Cannot be programmed

Name	Description
Positioning (G00)	○ (Positioning of linear interpolation type)
Single direction positioning (G60)	×
Exact stop (G09)	○
Exact stop mode (G61)	○
Tapping mode (G63)	×
Automatic corner override (G62)	×
Linear interpolation (G01)	○
Circular interpolation (G02,G03)	○ (Multiple quadrants allowed)
Helical interpolation (G02,G03)	○ (Circular interpolation) + (Up to four axes for linear interpolation) When the helical interpolation function is selected, up to two axes for linear interpolation can be specified. When the helical interpolation B function is selected, up to four axes for linear interpolation can be specified. A desired feedrate must be specified by also taking movement along the helical axis into consideration.
Spiral interpolation/conical interpolation (G02,G03)	○
Involute interpolation (G02.2,G03.2)	×
Exponential interpolation (G02.3,G03.3)	×
Dwell (G04)	○ (For a specified number of seconds or revolutions) To specify a number of revolutions for the dwell, the thread cutting/synchronous feed function must be selected.
Polar coordinate interpolation (G12.1,G13.1)	×
Cylindrical interpolation (G07.1)	×
Thread cutting/synchronous feed (G33)	×
Skip function (G31)	○ *
High-speed skip function (G31)	○ *
Multistage skip function (G31 Px)	○ *
Reference position return (G28)	○ * When the zero point is not established, P/S alarm No. 90 is issued.
Reference position return check (G27)	○ *
2nd, 3rd, and 4th reference position return (G30)	○ *
Floating reference position return (G30.1)	○ *
Canned cycle (G73 A G89)	○ *
Rigid tapping	×

Name	Description
Return to initial point in canned cycle (G98) /Return to R point in canned cycle (G99)	○ *
Normal direction control (G41.1,G42.1)	×
Continuous dressing	×
In-feed control	×
Index table indexing G161)	×
High-speed cycle machining	×
Absolute command (G90)/ Incremental command (G91)	○

Feed functions

- Can be programmed
× Cannot be programmed

Name	Description
Rapid traverse rate	Up to 240m/min (0.001mm) Up to 100m/min (0.0001mm)
Rapid traverse rate override	F0, 25, 50, 100 %
Rapid traverse rate override in units of 1%	0% to 100%
Feed per minute (G94)	○
Feed per rotation (G95)	×
Rapid traverse bell-shaped acceleration/deceleration	×
Cutting feed linear acceleration/deceleration before interpolation	○ (look-ahead control of up to 15 blocks)
Feedrate override	0% to 254%
Second feedrate override	×
Feed by F command with one digit	×
Inverse time feed (G93)	×
External deceleration	○

Tool compensation functions

- Can be programmed
× Cannot be programmed

Name	Description
Cutter compensation C (G40,G41,G42)	○
Tool length compensation (G43,G44,G49)	○

Program input

- Can be programmed
 × Cannot be programmed

Name	Description
Plane selection (G17,G18,G19)	○
Local coordinate system (G52)	○ *
Workpiece coordinate system (G54–G59) (G54.1Pxx)	○ *
Workpiece coordinate system (G92)	○
Workpiece coordinate system preset (G92.1)	○ *
Interruption-type custom macro	×

Others

- Can be programmed
 × Cannot be programmed

Name	Description
Cycle start/Feed hold	○
Dry run	○
Single block	○
Interlock	○
Machine lock	○ When an axis machine lock signal (MLK1 to MLK8) is set on or off, acceleration/deceleration is not performed on the axis held under the machine lock.
Control-in/control-out command ()	○
Optional block skip command (/n: n is a number)	○
Miscellaneous function (Mxxxx)	○ Only the function code signal and function strobe signal are output.
Spindle function (Sxxxx)	○
Tool function (Txxxx)	○ Only the function code signal and function strobe signal are output.
Second auxiliary function (Bxxxx)	○ Only the function code signal and function strobe signal are output.
Simple synchronous control	○ Synchronous control cannot be enabled or disabled.
Program restart	×
Retrace function	×
Tool life management	×
Macro executor (execution macro)	×

Name	Description
MDI operation	× When G05.1 Q1 is specified in MDI mode, P/S alarm No. 5113 is issued. The operation mode cannot be switched to MDI mode in simple high-precision contour control mode.
Manual intervention	× Upon restart after manual intervention, the position at which manual intervention occurred must be restored. If the position is not restored, P/S alarm No. 5114 is issued.

Those functions marked with an asterisk (*) do not perform look-ahead control of multiple blocks.

Limitations

- **Conditions for entering simple high-precision contour control mode**

Before G05.1 Q1, the following modal codes must be specified. If this condition is not satisfied, P/S alarm No. 5111 will be issued.

G code	Description
G00	Positioning
G01	Linear interpolation
G02	Circular interpolation (CW)
G03	Circular interpolation (CCW)
G13.1	Polar coordinate interpolation cancel mode
G15	Polar coordinate command cancel
G25	Spindle speed fluctuation detection off
G40	Cutter compensation cancel
G40.1	Normal direction control cancel mode
G49	Tool length compensation cancel
G50	Scaling cancel
G50.1	Programmable mirror image cancel
G64	Cutting mode
G67	Macro modal call cancel
G69	Coordinate rotation cancel
G80	Canned cycle cancel
G94	Feed per minute
G97	Constant surface speed control cancel
G160	In-feed control function cancel

- **Manual handle interruption**

Manual handle interruption is disabled while the mode is being switched to simple high-precision contour control mode.

19.7 DISTRIBUTION PROCESSING TERMINATION MONITORING FUNCTION FOR THE HIGH-SPEED MACHINING COMMAND (G05)

During high-speed machining, the distribution processing status is monitored. When distribution processing terminates, P/S alarm No. 000 and P/S alarm No. 179 are issued upon completion of the high-speed machining command (according to the setting of ITPDL (bit 7 of parameter No. 7501)).

These P/S alarms can be canceled only by turning off the CNC power.

Explanations

- High-speed machining command
- Distribution processing termination

High-speed machining using the high-speed remote buffer A function, high-speed remote buffer B function, and high-speed cycle function based on the G05 command

Failure to perform normal distribution processing because distribution processing required for high-speed machining exceeded the CNC processing capacity, or because distribution data sent from the host was delayed for some reason while the high-speed remote buffer A or G function was being used

Alarm

Alarm No.	Message	Contents
000	PLEASE TURN OFF POWER	During high-speed machining, distribution processing was terminated. Related parameters: Remote buffer transfer baud rate (parameter No. 133)
179	PARAM. (PRM No. 7510) SETTING ERROR	Number of controlled axes in high-speed machining (parameter No. 7150) High-speed axis selection during high-speed machining (bit 0 of parameter No. 7510)

19.8 HIGH-SPEED LINEAR INTERPOLATION (G05)

Format

The high-speed linear interpolation function processes a move command related to a controlled axis not by ordinary linear interpolation but by high-speed linear interpolation. The function enables the high-speed execution of an NC program including a series of minute amounts of travel.

```
G05 P2 ; Start high-speed linear interpolation
G05 P0 ; End high-speed linear interpolation

A block for specifying G05 must not contain any other command.
```

Explanations

- High-speed linear interpolation mode

The high-speed linear interpolation start command G05 P2; places the system in high-speed linear interpolation mode, in which high-speed linear interpolation is executed. The high-speed linear interpolation end command G05 P0; places the system in the standard NC program operation mode.

At power-up or in the NC reset state, the system enters the standard NC program operation mode.

- Commands in high-speed linear interpolation mode

The commands that can be programmed in high-speed linear interpolation mode are:

X/Y/Z/C-axis incremental travel distance command, cutting feedrate command, and high-speed linear interpolation end command.

In high-speed linear interpolation mode, an address other than those listed in the following table is ignored.

Address	Description
X—.—	X-axis incremental travel distance
Y—.—	Y-axis incremental travel distance
Z—.—	Z-axis incremental travel distance
C—.—	C-axis incremental travel distance
G05 P0 ;	High-speed linear interpolation end command

- X/Y/Z/C-axis incremental traveling distance

A travel distance specified in high-speed linear interpolation mode is regarded as being an incremental travel distance, regardless of the G90/G91 mode setting.

- Cutting feedrate

Specify a cutting feedrate in high-speed linear interpolation mode. If no cutting feedrate is specified, the modal F value is assumed.

	Maximum feedrate	Interpolation period: 8 msec	Interpolation period: 4 msec
(IS-B, metric input)	122,848	mm/min	245,696 mm/min
(IS-B, inch input)	12,284.8	inch/min	24,569.6 inch/min
(IS-C, metric input)	12,284	mm/min	24,569 mm/min
(IS-C, inch input)	1,228.48	inch/min	2,456.96 inch/min

(Maximum feedrate) =

$$122,848 \times \frac{8}{(\text{interpolation period})} \text{ (IS-B, metric input)}$$

Minimum feedrate	Interpolation period: 8 msec	Interpolation period: 4 msec
(IS-B, metric input)	4 mm/min	8 mm/min
(IS-B, inch input)	0.38 inch/min	0.76 inch/min
(IS-C, metric input)	4 mm/min	8 mm/min
(IS-C, inch input)	0.38 inch/min	0.76 inch/min

$$(\text{Minimum feedrate}) = 4 \times \frac{8}{(\text{interpolation period})} \quad (\text{IS-B, metric input})$$

- **Interpolation period**

In high-speed linear interpolation mode, the NC interpolation period can be changed. As the interpolation period decreases, the machining speed and precision increase.

IT2, IT1, and IT0 bits (bits 6, 5, and 4 of parameter 7501)

IT2	IT1	IT0	Interpolation period
0	0	0	8 msec in high-speed linear interpolation mode
0	1	0	4 msec in high-speed linear interpolation mode
0	0	1	2 msec in high-speed linear interpolation mode
0	1	1	1 msec in high-speed linear interpolation mode
1	1	1	0.5 msec in high-speed linear interpolation mode

Limitations

- **Controlled axes**

Up to four axes can be controlled. The names of the controlled axes are X, Y, Z, and C. Any other axis name is ignored. Set X, Y, Z, then C in axis name setting parameter 1020.

- **Enabled interpolation**

Only the linear interpolation function can be executed. Circular interpolation and other interpolation functions cannot be executed.

- **Absolute command**

Movement cannot be specified by absolute values. A specified travel distance is always considered as an incremental travel distance, regardless of the G90/G91 mode setting.

- **Feed per rotation**

The feed per rotation command cannot be specified. Feed per minute is always assumed, regardless of the G94/G95 mode setting.

- **Cutter compensation**

High-speed linear interpolation commands cannot be specified in cutter compensation mode (G41/G42). If the high-speed linear interpolation start command is specified in cutter compensation mode, P/S alarm No. 178 is issued.

- **Modes related to the coordinate system**

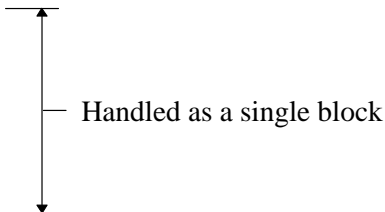
The high-speed interpolation commands cannot be specified in polar coordinate interpolation mode (G12.1), scaling mode (G51), or coordinate system rotation mode.

- **Single-block operation** Single-block operation is disabled in high-speed linear interpolation mode.

```

:
G05 P2 ;
X10 Z20 F1000 ;
:
:
:
Y30 ;
G05 P0 ;
:

```



- **Feed hold** Feed hold is disabled in high-speed linear interpolation mode.

- **Cutting feed override** The cutting feed override function is enabled. Because of the intermediate buffer between high-speed linear interpolation processing and axis move command processing, the override is applied only after the elapse of a slight delay after the override signal is switched.

- **Maximum cutting feedrate for each axis** The maximum cutting feedrate for each axis (parameter 1430) is invalid in high-speed linear interpolation mode. The maximum cutting feedrate for all axes (parameter 1422) becomes valid.

- **Custom macro/optional block skip** No macro variables or macro statements can be used in high-speed linear interpolation mode. If their use is attempted, P/S alarm No. 009 is issued. When an optional block skip symbol / is specified, P/S alarm No. 009 is issued as well.

- **Comment** No comment can be specified.

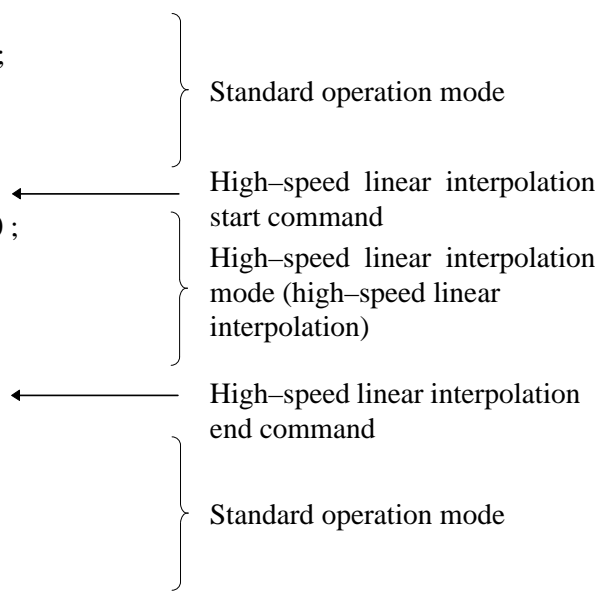
- **G codes** If a G code other than G05 P0 is specified in high-speed linear interpolation mode, P/S alarm No. 010 is issued.

Example

<Sample program>

```

NC program
O0001 ;
G00 X0 Y0 Z0 ;
:
:
:
G05 P2 ;
X10 Y20 F1000 ;
X5 Y6 Z7 ;
:
:
:
G05 P0 ;
G00 DDD ;
:
:
:
M02 ;
%
```



20

AXIS CONTROL FUNCTIONS



20.1 SIMPLE SYNCHRONOUS CONTROL

It is possible to change the operating mode for two or more specified axes to either synchronous operation or normal operation by an input signal from the machine.

Synchronous control can be performed for up to four pairs of axes with the Series 16, or up to three pairs with the Series 18, according to the parameter setting (parameter No. 8311).

The following operating modes are applicable to machines having two tables driven independently by separate control axes. The following example is of a machine with two tables driven independently by the Y axis and V axis. If the axis names and axis sets that are actually being used differ from those in the example, substitute the actual names for those below.

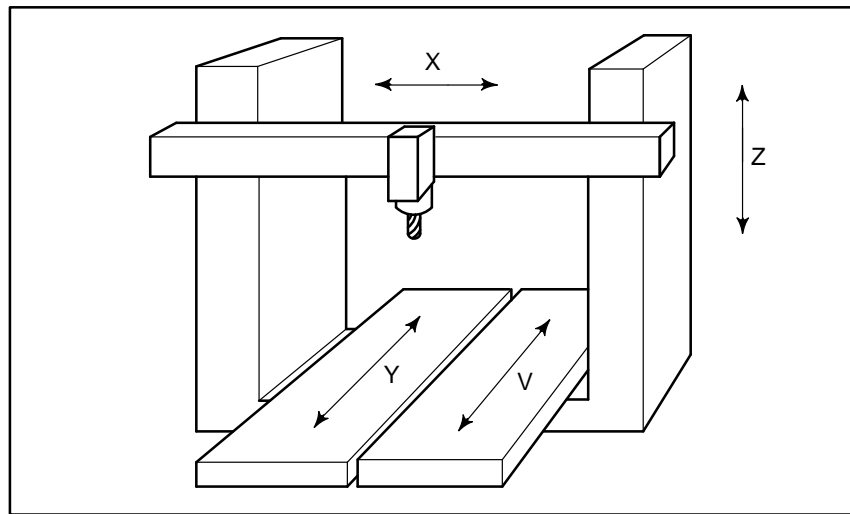


Fig. 20(a) Example of axis configuration of the machine operated by simple synchronous control

Explanations

- Synchronous operation

This mode is used for, for example, machining large workpieces that extend over two tables.

While operating one axis with a move command, it is possible to synchronously move the other axis. In the synchronous mode, the axis to which the move command applies is called the master axis, and the axis that moves synchronously with the master axis is called the slave axis. In this example, it is assumed that Y axis is the master axis and V axis is the slave axis. Here, the Y axis and the V axis move synchronously in accordance with program command Yyyy issued to the Y axis (master axis).

Synchronous operation here means that the move command for the master axis is issued simultaneously to both the servo motor for the master axis and that for the slave axis. In synchronous operation, the servo motor for the slave axis is not compensated for the deviation which is always detected between the two servo motors.

Deviation alarms are also not detected. Synchronous operation is possible during automatic operation, jog feed, manual handle feed using the manual pulse generator, and incremental feed, but is not possible during manual reference position return.

- **Normal operation**

This operating mode is used for machining different workpieces on each table. The operation is the same as in ordinary CNC control, where the movement of the master axis and slave axis is controlled by the independent axis address (Y and V). It is possible to issue the move commands to both the master axis and slave axis in the same block.

 - (1) The Y axis moves normally according to program command Yyyyy issued to the master axis.
 - (2) The V axis moves normally according to program command Vvvvv issued to the slave axis.
 - (3) The Y axis and the V axis move simultaneously according to program command YyyyyVvvvv.

Both automatic and manual operations are the same as in ordinary CNC control.

- **Switching between synchronous operation and normal operation**

For how to switch between the synchronous operation and normal operation modes, refer to the relevant manual published by the machine tool builder.

- **Automatic reference position return**

When the automatic reference position return command (G28) and the 2nd/3rd/4th reference position return command (G30) are issued during synchronous operation, the V axis follows the same movement as the Y axis returns to the reference position. If the V axis is positioned at the reference position after the return movement is complete, the reference position return complete signal of the V axis goes on when that of the Y axis goes on.

As a rule, commands G28 and G30 must be issued in the normal operating mode.

- **Automatic reference position return check**

When the automatic reference position return check command (G27) is issued during synchronous operation, the V axis and Y axis move in tandem. If both the Y axis and the V axis have reached their respective reference positions after the movement is complete, the reference position return complete signals go on. If either axis is not at the reference position, an alarm is issued. As a rule, command G27 must be issued in the normal operating mode.

- **Specifying the slave axis**

When a move command is issued to the slave axis during synchronous operation, a P/S alarm (No. 213) is issued.

- **Master axis and slave axis**

The axis to be used as the master axis is set in parameter No. 8311. The slave axis is selected by an external signal.

- **Displaying actual speed for master axis only**

Setting bit 7 (SMF) of parameter No. 3105 to 1 suppresses display of the actual speed of the slave axes.

Limitations

- **Setting a coordinate system**

In synchronous axis control, commands that require no axis motion, such as the workpiece coordinate system setup command (G92) and the local coordinate system setup command (G52), are set to the Y axis by program command Yyyyy issued to the master axis.
- **Externally-requested deceleration, interlock, and machine lock**

For signals such as external deceleration, interlock, and machine lock, only the signals issued to the master axis are valid in the synchronous operating mode. Signals issued to other axes are ignored.
- **Pitch error compensation**

Both the pitch error and backlash are compensated independently for the master axis and the slave axis.
- **Manual absolute**

Turn on the manual absolute switch during synchronous operation. If it is off, the slave axis may not move correctly.
- **Synchronization error check using positional deviation**

The difference between the master axis and slave axis in servo positional deviation is always monitored. If the difference exceeds the parameter-set limit, an P/S alarm (No. 213) is issued.
- **Synchronization error check using machine coordinates**

The difference between the master axis and slave axis in machine coordinates is always monitored. If the difference exceeds the parameter-set limit, an P/S alarm (No. 407) is issued.
- **Synchronization**

When the power is turned on, compensation pulses are output for the slave axis to match the machine position of the master axis with the machine position of the slave axis. (This is enabled only when the absolute position detection function is used.)
- **Compensation for out-of-synchronism**

Compensation for out-of-synchronism (where the difference between the master and slave axes in servo positional deviation is always monitored and the servo motor for the slave axis is compensated to reduce the difference) is not performed.
- **Manual reference position return**

When the machine is manually returned to the reference position during synchronous operation, both the master axis and the slave axis move synchronously until the acceleration movement is complete. However, grid detection thereafter is carried out independently.

20.2 ROTARY AXIS ROLL-OVER

Explanations

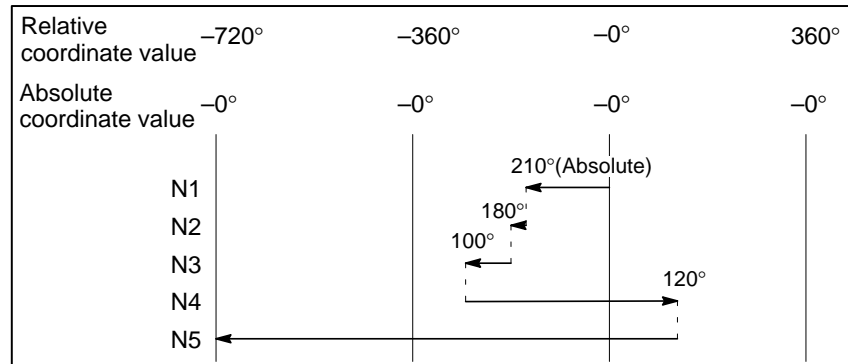
The roll-over function prevents coordinates for the rotation axis from overflowing. The roll-over function is enabled by setting bit 0 of parameter ROAx 1008 to 1.

For an incremental command, the tool moves the angle specified in the command. For an absolute command, the coordinates after the tool has moved are values set in parameter No. 1260, and rounded by the angle corresponding to one rotation. The tool moves in the direction in which the final coordinates are closest when bit 1 of parameter RABx No. 1008 is set to 0. Displayed values for relative coordinates are also rounded by the angle corresponding to one rotation when bit 2 of parameter RRLx No. 1008 is set to 1.

Examples

Assume that axis A is the rotating axis and that the amount of movement per rotation is 360.000 (parameter No. 1260 = 360000). When the following program is executed using the roll-over function of the rotating axis, the axis moves as shown below.

G90 A0 ;	Sequence number	Actual movement value	Absolute coordinate value after movement end
N1 G90 A-150.0 ;	N1	-150	210
N2 G90 A540.0 ;	N2	-30	180
N3 G90 A-620.0 ;	N3	-80	100
N4 G91 A380.0 ;	N4	+380	120
N5 G91 A-840.0 ;	N5	-840	0



NOTE

This function cannot be used together with the indexing function of the index table.

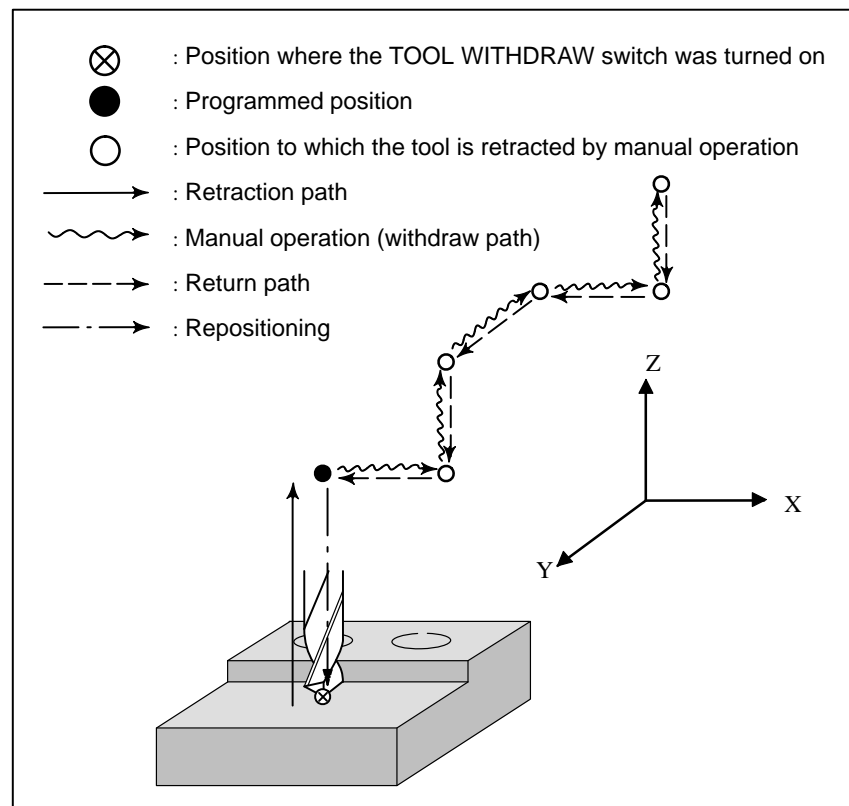
20.3 TOOL WITHDRAWAL AND RETURN (G10.6)

To replace the tool damaged during machining or to check the status of machining, the tool can be withdrawn from a workpiece. The tool can then be advanced again to restart machining efficiently.

The tool withdrawal and return operation consists of the following four steps:

- **Retract**
The tool is retracted to a predefined position using the TOOL WITHDRAW switch.
- **Withdrawal**
The tool is moved to the tool-change position manually.
- **Return**
The tool returns to the retract position.
- **Repositioning**
The tool returns to the interrupted position.

For the tool withdrawal and return operations, see III-4.10.



Format

Specify a retraction axis and distance in the following format:

Specify the amount of retraction, using G10.6.

G10.6 P₋ ;

P₋ : In incremental mode, retraction distance from the position where the retract signal is turned on
In the absolute mode, retraction distance to an absolute position
The specified amount of retraction is effective until G10.6 is next executed. To cancel the retraction, specify the following:

G10.6 ; (as a single block containing no other commands)

Explanations

● Retraction

When the TOOL WITHDRAW switch on the machine operator's panel is turned on during automatic operation or in the automatic operation stop or hold state, the tool is retracted the length of the programmed retraction distance. This operation is called retraction. The position at which retraction is completed is called the retraction position. Upon completion of retraction, the RETRACT POSITION LED on the machine operator's panel goes on.

When the TOOL WITHDRAW switch is turned on during execution of a block in automatic operation, execution of the block is interrupted immediately and the tool is retracted. After retraction is completed, the system enters the automatic operation hold state.

If the retraction distance and direction are not programmed, retraction is not performed. In this state, the tool can be withdrawn and returned.

When the TOOL WITHDRAW switch is turned on in the automatic operation stop or hold state, the tool is retracted, then the automatic operation stop or hold state is entered again.

When the TOOL WITHDRAW switch is turned on, the tool withdraw mode is set. When the tool withdraw mode is set, the TOOL BEING WITHDRAWN LED on the machine operator's panel goes on.

● Withdrawal

When the manual mode is set, the tool can be moved manually (Manual continuous feed or manual handle feed) to replace the tool or measure a machined workpiece. This operation is called a withdrawal. The tool withdrawal path is automatically memorized by the CNC.

● Return

When the mode is returned to automatic operation mode and the TOOL RETURN switch on the machine operator's panel is turned off, the CNC automatically moves the tool to the retraction position by tracing the manually-moved tool path backwards. This operation is called a return. Upon completion of a return to the retraction position, the RETRACTIONS POSITION LED comes on.

● Repositioning

When the cycle start button is pressed while the tool is in the retraction position, the tool moves to the position where the TOOL WITHDRAW switch was turned on. This operation is called repositioning. Upon completion of repositioning, the TOOL BEING WITHDRAWN LED is turned off, indicating that the tool withdrawal mode has terminated. Operation after completion of repositioning depends on the automatic operation state when the tool withdrawal mode is set.

- (1) When the tool withdrawal mode is set during automatic operation, operation is resumed after completion of repositioning.
- (2) When the tool withdrawal mode is set when automatic operation is held or stopped, the original automatic operation hold or stop state is set after completion of repositioning. When the cycle start button is pressed again, automatic operation is resumed.

Limitations

- **offset**

If the origin, presetting, or workpiece origin offset value (or External workpiece origin offset value) is changed after retraction is specified with G10.6 in absolute mode, the change is not reflected in the retraction position. After such changes are made, the retraction position must be respecified with G10.6.

When the tool is damaged, automatic operation can be interrupted with a tool withdrawal and return operation in order to replace the tool. Note that if the tool offset value is changed after tool replacement, the change is ignored when automatic operation is resumed from the start point or other point in the interrupted block.
- **Machine lock, mirror image, and scaling**

When withdrawing the tool manually in the tool withdrawal mode, never use the machine lock, mirror-image, or scaling function.
- **Thread cutting**

Tool withdrawal and return operation cannot be performed during thread cutting.
- **Drilling canned cycle**

Tool withdrawal and return operation cannot be performed during a drilling canned cycle.
- **Reset**

Upon reset, the retraction data specified in G10.6 is cleared. Retraction data needs to be specified again.
- **Retraction command**

The tool withdrawal and return function is enabled even when the retraction command is not specified. In this case, retraction and repositioning are not performed.

WARNING

The retraction axis and retraction distance specified in G10.6 need to be changed in an appropriate block according to the figure being machined. Be very careful when specifying the retraction distance; an incorrect retraction distance may damage the workpiece, machine, or tool.

20.4 TANDEM CONTROL

When enough torque for driving a large table cannot be produced by only one motor, two motors can be used for movement along a single axis. Positioning is performed by the main motor only. The submotor is used only to produce torque. With this tandem control function, the torque produced can be doubled.

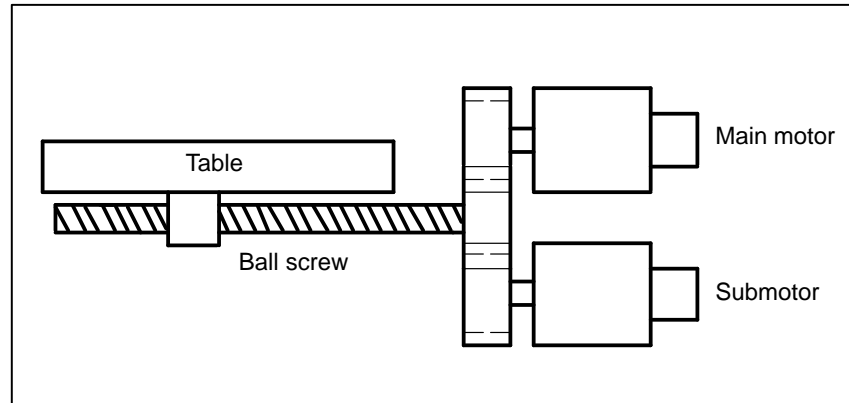
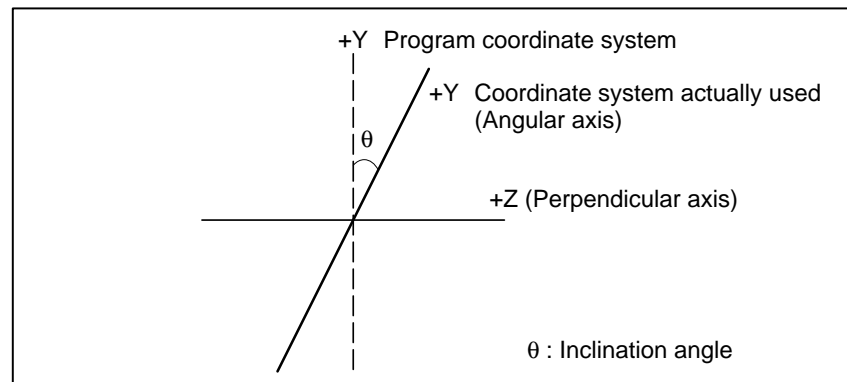


Fig. 20.4 (a) Example of operation

In general, the NC regards tandem control as being performed for one axis. However, for servo parameter management and servo alarm monitoring, tandem control is regarded as being performed for two axes. For details, refer to the relevant manual published by the machine tool builder.

20.5 ANGULAR AXIS CONTROL/ANGULAR AXIS CONTROL B

When the angular axis makes an angle other than 90° with the perpendicular axis, the angular axis control function controls the distance traveled along each axis according to the inclination angle. For the ordinary angular axis control function, the angular axis is always the Y-axis and the perpendicular axis is always the Z-axis. For angular axis control B, however, arbitrary axes can be specified as the angular and perpendicular axes, using parameters. A program, when created, assumes that the angular axis and perpendicular axis intersect at right angles. However, the actual distance traveled is controlled according to an inclination angle.



Explanations

When the angular axis is the Y-axis and the perpendicular axis is the Z-axis, the amount of travel along each axis is controlled according to the formulas shown below.

The distance traveled along the Y-axis is determined by the following formula:

$$Y_a = Y_p / \cos\theta$$

The distance traveled along the Z-axis is corrected by the inclination of the Y-axis, and is determined by the following formula:

$$Z_a = Z_p - Y_p * \tan\theta$$

The speed component along the Y-axis is determined by the following formula:

$$F_a = F_p / \cos\theta$$

Y_a, Z_a, F_a : Actual distance and speed

Y_p, Z_p, F_p : Programmed distance and speed

- **Method of use**

The angular and perpendicular axes for which angular axis control is to be applied must be specified beforehand, using parameters (No. 8211 and 8212).

Parameter AAC (No. 8200#0) enables or disables the inclined axis control function. If the function is enabled, the distance traveled along each axis is controlled according to an inclination angle parameter (No. 8210).

Parameter AZR (No. 8200#2) enables angular axis manual reference point return only with a distance along the angular axis.

- **Invalidity of normal axis**

By setting the normal axis/angular axis control invalid signal NOZAGC to 1, slanted axis control only for the angular axis can be available.

In this time the angular axis are converted to those along the slanted coordinate system without affecting commands to normal axis.

- **Absolute and relative position display**
- **Machine position display**

An absolute and a relative position are indicated in the programmed Cartesian coordinate system.

A machine position indication is provided in the machine coordinate system where an actual movement is taking place according to an inclination angle. However, when inch/metric conversion is performed, a position is indicated which incorporates inch/metric conversion applied to the results of inclination angle operation.

WARNING

- 1 After angular axis control parameter setting, be sure to perform manual reference position return operation.
- 2 If bit 2 (AZK) of parameter No. 8200 has been set to 0, such that manual reference position return along the angular axis also causes movement along the perpendicular axis, once manual reference position return has been performed along the angular axis, also perform manual reference position return along the perpendicular axis.
- 3 Once the tool has been moved along the angular axis when perpendicular/angular axis control disable signal NOZAGC has been set to 1, manual reference position return must be performed.
- 4 Before attempting to manually move the tool along the angular and perpendicular axes simultaneously, set perpendicular/angular axis control disable signal NOZAGC to 1.

NOTE

- 1 For angular axis control B, if the same axis number has been specified in both parameters No.8211 and 8212, or if a value outside the valid data range has been specified for either parameter, the angular and perpendicular axes become the following:
Angular axis: Second axis
Perpendicular axis: Third axis
- 2 If an inclination angle close to 0° or $\pm 90^\circ$ is set, an error can occur. (A range from $\pm 20^\circ$ to $\pm 90^\circ$ should be used.)
- 3 Before a perpendicular axis reference position return check (G27) can be made, angular axis reference position return operation must be completed.

20.6 CHOPPING FUNCTION (G80, G81.1)

When contour grinding is performed, the chopping function can be used to grind the side face of a workpiece. By means of this function, while the grinding axis (the axis with the grinding wheel) is being moved vertically, a contour program can be executed to instigate movement along other axes.

In addition, a servo delay compensation function is supported for chopping operations. When the grinding axis is moved vertically at high speed, a servo delay and acceleration/deceleration delay occur. These delays prevent the tool from actually reaching the specified position. The servo delay compensation function compensates for any displacement by increasing the feedrate. Thus, grinding can be performed almost up to the specified position.

There are two types of chopping functions: that specified by programming, and that activated by signal input. For details of the chopping function activated by signal input, refer to the manual provided by the machine tool builder.

Format

G81.1 Z__ Q__ R__ F__ ;

Z : Upper dead point
(For an axis other than the Z-axis, specify the axis address.)
Q : Distance between the upper dead point and lower dead point
(Specify the distance as an incremental value, relative to the upper dead point.)
R : Distance from the upper dead point to point R
(Specify the distance as an incremental value, relative to the upper dead point.)
F : Feedrate during chopping

G80; Cancels chopping

Explanations

- **Chopping activated by signal input**

Before chopping can be started, the chopping axis, reference position, upper dead point, lower dead point, and chopping feedrate must be set using the parameter screen (or the chopping screen).

For details, refer to the manual provided by the machine tool builder.

- **Chopping feedrate (feedrate of movement to point R)**

From the start of chopping to point R, the tool moves at the rapid traverse rate (specified by parameter No. 1420).

The override function can be used for either the normal rapid traverserate or chopping feedrate, one of which can be selected by setting CPRPD (bit 0 of parameter No. 8360).

When the chopping feedrate is overridden, settings between 110% and 150% are clamped to 100%.

- **Chopping feedrate (feedrate of movement from point R)**

Between point R, reached after the start of chopping, and the point where the chopping is canceled, the tool moves at the chopping feedrate (specified by parameter No. 8374).

The chopping feedrate is clamped to the maximum chopping feedrate (set with parameter No. 8375) if the specified feedrate is greater than the maximum chopping feedrate.

The feedrate can be overridden by 0% to 150% by applying the chopping feedrate override signal.

● Setting chopping data

Set the following chopping data:

- Chopping axis: Parameter No. 8370
- Reference point (point R): Parameter No. 8371
- Upper dead point: Parameter No. 8372
- Lower dead point: parameter No. 8373
- Chopping feedrate: Parameter No. 8374
- Maximum chopping feedrate: Parameter No. 8375

All data items other than the chopping axis and maximum chopping feedrate can be set on the chopping screen.

For details of how to set chopping data on the chopping screen, refer to III 11.4.13 Displaying and Setting Chopping Data.

● Chopping after the upper dead point or lower dead point has been changed

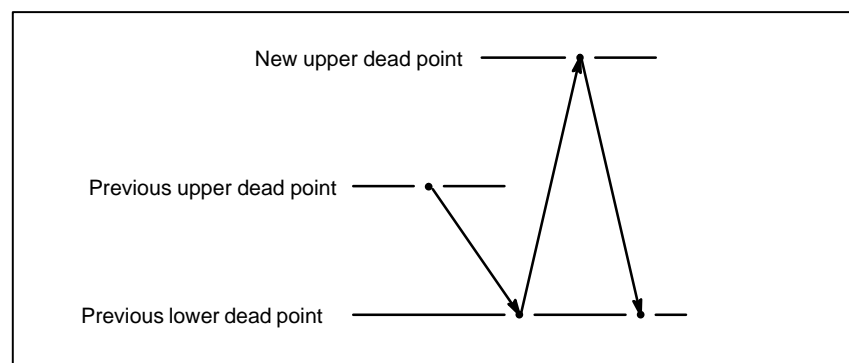
When the upper dead point or lower dead point is changed while chopping is being performed, the tool moves to the position specified by the old data. Then, chopping is continued using the new data.

While chopping is being performed, data can be changed only on the chopping screen. Changing the data on the parameter screen has no effect on the current chopping operation.

When movement according to the new data starts, the servo delay compensation function stops the servo delay compensation for the old data, and starts the servo delay compensation for the new data.

The following describes the operations performed after the data has been changed.

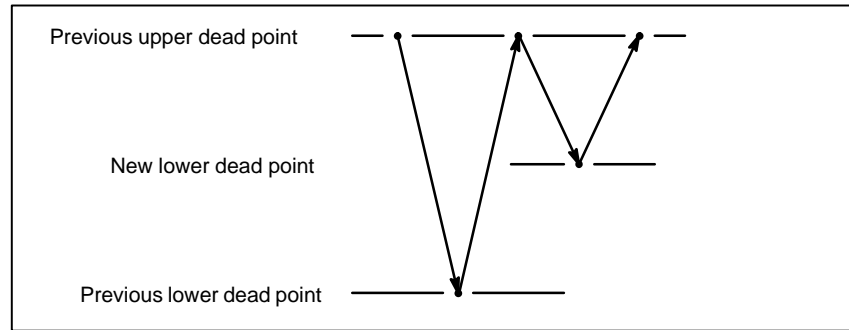
- (1) When the upper dead point is changed during movement from the upper dead point to the lower dead point



The tool first moves to the lower dead point, then to the new upper dead point.

Once movement to the lower dead point has been completed, the previous servo delay compensation is set to 0, and servo delay compensation is performed based on the new data.

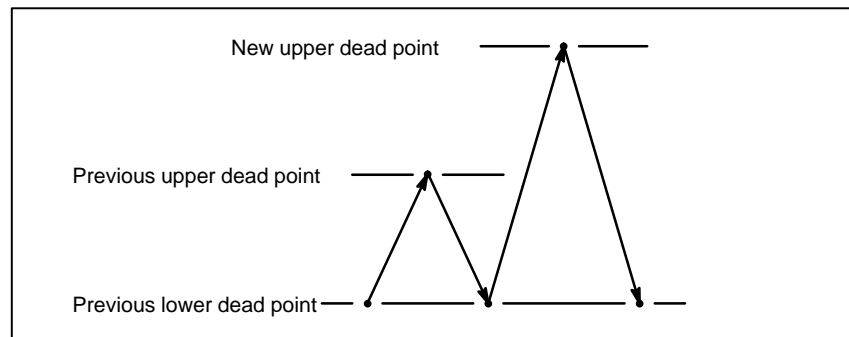
- (2) When the lower dead point is changed during movement from the upper dead point to the lower dead point



The tool first moves to the previous lower dead point, then to the upper dead point, and finally to the new lower dead point.

Once movement to the upper dead point has been completed, the previous servo delay compensation is set to 0, and servo delay compensation is performed based on the new data.

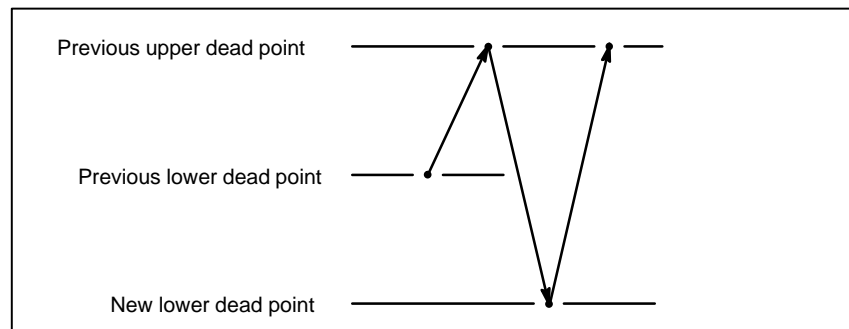
- (3) When the upper dead point is changed during movement from the lower dead point to the upper dead point



The tool first moves to the previous upper dead point, then to the lower dead point, and finally to the new upper dead point.

Once movement to the lower dead point has been completed, the previous servo delay compensation is set to 0, and servo delay compensation is performed based on the new data.

- (4) When the lower dead point is changed during movement from the lower dead point to the upper dead point



The tool first moves to the upper dead point, then to the new lower dead point.

Once movement to the upper dead point has been completed, the previous servo delay compensation is set to 0, and servo delay compensation is performed based on the new data.

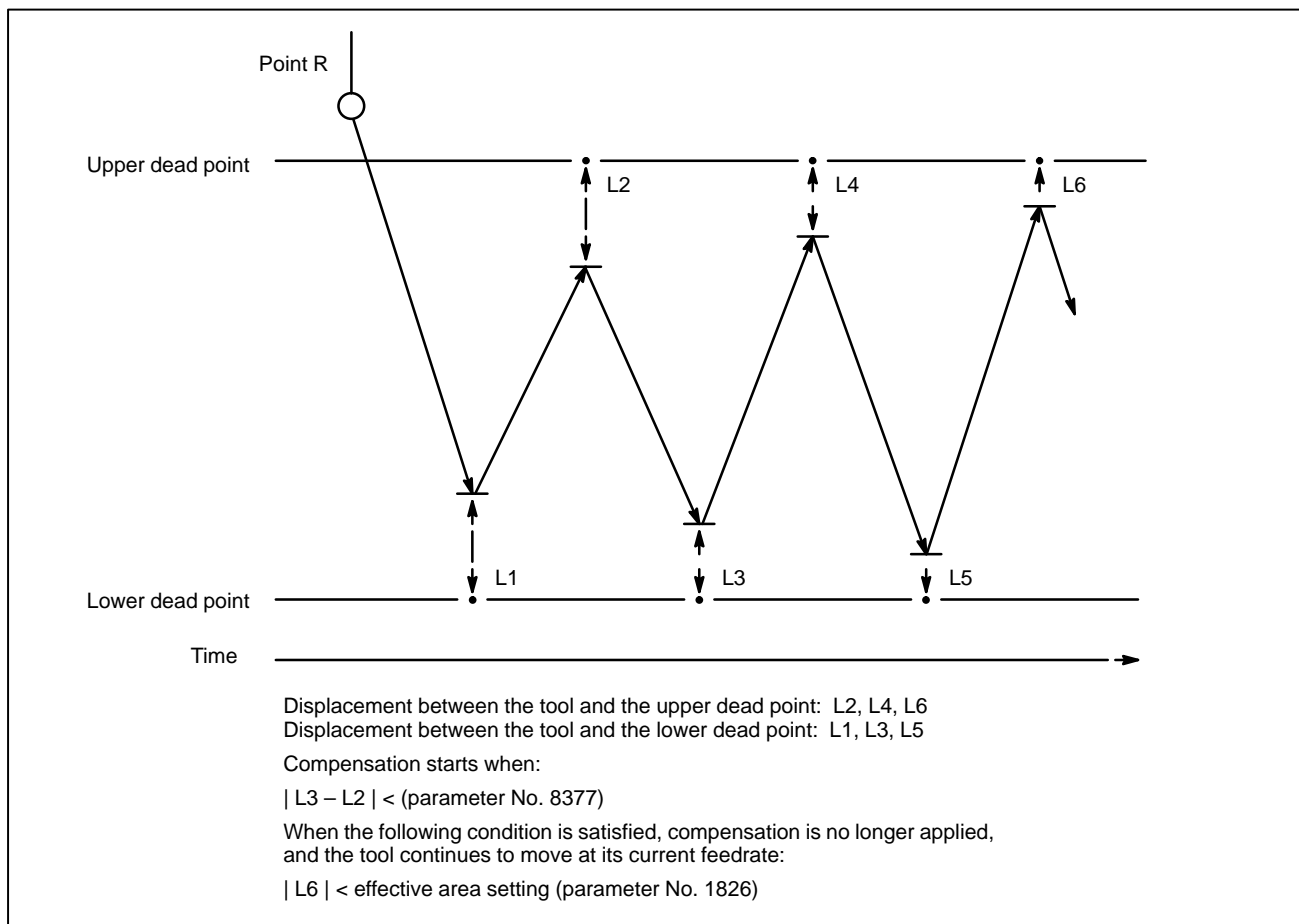
- **Servo delay compensation function**

When high-speed chopping is performed with the grinding axis, a servo delay and acceleration/deceleration delay occur. These delays prevent the tool from actually reaching the specified position. The control unit measures the difference between the specified position and the actual tool position, and automatically compensates for the displacement of the tool. To compensate for this displacement, an amount of travel equal to the distance between the upper and lower dead points, plus an appropriate compensation amount, is specified. When a chopping command is specified, the feedrate is determined so that the chopping count per unit time equals the specified count. When the difference between the displacement of the tool from the upper dead point and the displacement of the tool from the lower dead point becomes smaller than the setting of parameter No. 8377, after the start of chopping, the control unit performs compensation.

When compensation is applied, the chopping axis moves beyond the specified upper dead point and lower dead point, and the chopping feedrate increases gradually.

When the difference between the actual machine position and the specified position becomes smaller than the effective area setting (parameter No. 1826), the control unit no longer applies compensation, allowing the tool to continue moving at its current feedrate.

A coefficient for the compensation amount for the displacement generated by the servo delay incurred by chopping and the delay incurred during acceleration/deceleration can be specified in parameter No. 8376.



- **Mode switching during chopping**

If the mode is changed during chopping, chopping does not stop. In manual mode, the chopping axis cannot be moved manually. It can, however, be moved manually by means of the manual interrupt.

- **Reset during chopping**

When a reset is performed during chopping, the tool immediately moves to point R, after which chopping mode is canceled.

If an emergency stop or servo alarm occurs during chopping, mode is canceled, and the tool stops immediately.

- **Stopping chopping**

The following table lists the operations and commands that can be used to stop chopping, the positions at which chopping stops, and the operation performed after chopping stops:

Operation/command	Stop position	Operation after chopping stops
G80	Point R	Canceled
CHPST: "0"	The tool moves to the lower dead point, then to point R.	Canceled
*CHLD: "0"	Point R	Restart after *CHLD goes "1"
Reset	Point R	Canceled
Emergency stop	The tool stops immediately.	Canceled
Servo alarm	The tool stops immediately.	Canceled
P/S alarm	The tool moves to the lower dead point, then to point R.	Canceled
OT alarm	The tool moves from the upper or lower point to point R.	Canceled

- **Background editing**

When an alarm or battery alarm is issued during background editing, the tool does not stop at point R.

- **Single block signal**

Even when single block signal SBK is input during chopping, chopping continues.

Limitations

- **Workpiece coordinate system**

While chopping is being performed, do not change the workpiece coordinate system for the chopping axis.

- **PMC axis**

When the chopping axis is selected as the PMC axis, chopping is not started.

- **Mirror image**

While chopping is being performed, never attempt to apply the mirror image function about the chopping axis.

- **Move command during chopping**

If a move command is specified for the chopping axis while chopping is being performed, a P/S 5050 alarm is issued.

- **Look-ahead control**

This function does not support the look-ahead control function.

- **Program restart**

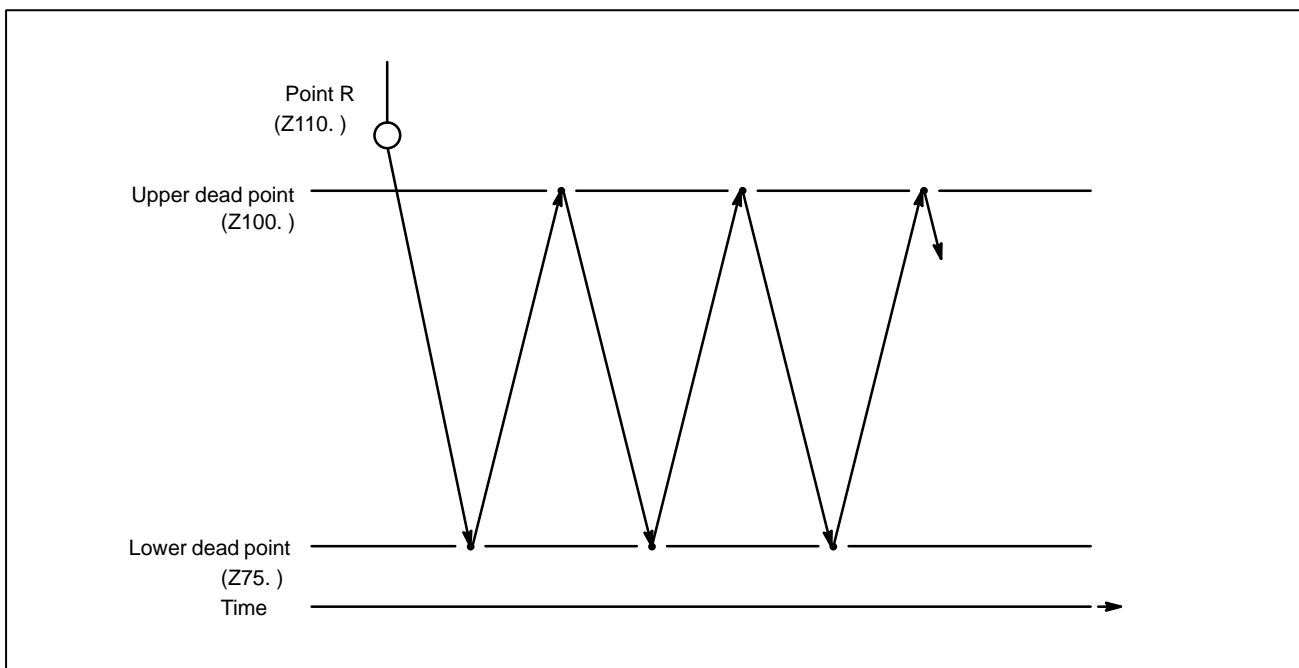
When a program contains G codes for starting chopping (G81.1) and stopping chopping (G80), an attempt to restart that program results in a P/S 5050 alarm being output.

When a program that does not include the chopping axis is restarted during chopping, the coordinates and amount of travel set for the chopping axis are not affected after the restart of the program.

Examples

G90 G81.1 Z100. Q-25. R10. F3000 ;

- Perform rapid traverse to position the tool to Z110. (point R).
- Then, perform reciprocating movement along the Z-axis between Z100. (upper dead point) and Z75. (lower dead point) at 3000 mm/min. Chopping override is enabled.



To cancel chopping, specify the following command:

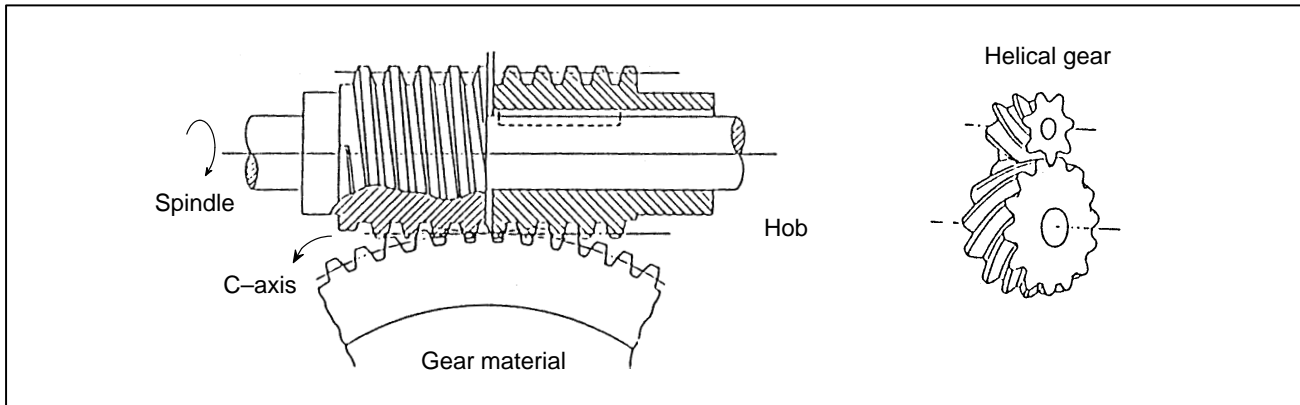
G80 ;

- The tool stops at point R.

20.7 HOBBING MACHINE FUNCTION (G80, G81)

Gears can be cut by turning the workpiece (C-axis) in sync with the rotation of the spindle (hob axis) connected to a hob.

Also, a helical gear can be cut by turning the workpiece (C-axis) in sync with the motion of the Z-axis (axial feed axis).



Format

G81 T_L_Q_P_;

- T** : Number of teeth (Specifiable range: 1 to 5000)
- L** : Number of hob threads (Specifiable range: 1 to 20 with a sign)
 - The sign of L specifies the direction of rotation of the C-axis.
 - If L is positive, the C-axis rotates in the positive direction (+).
 - If L is negative, the C-axis rotates in the negative direction (-).
- Q** : Module or diametral pitch
 - For metric input, specify a module.
 - (Unit: 0.00001 mm, Specifiable range: 0.01 to 25.0 mm)
 - For inch input, specify a diametral pitch.
 - (Unit: 0.00001 inch⁻¹, Specifiable range: 0.01 to 250.0 inch⁻¹)
- P** : Gear helix angle
 - (Unit: 0.0001 deg, Specifiable range: -90.0 to +90.0 deg)

P and Q must be specified when a helical gear is to be cut.

G80; Cancels synchronization between the hob axis and C-axis.

Explanations

- **Setting the C-axis**

The C-axis (workpiece) is usually the fourth axis. However, any axis can be set as the C-axis by setting the corresponding parameter appropriately (parameter No. 7710).

- **Maintaining the synchronization status**

The synchronization status is maintained provided:

- The interlock signal for the C-axis is turned on.
- The feed hold state exists.

- **Releasing the synchronization status**

Synchronization between the hob axis and C-axis can also be canceled when:

- The power is turned off.
- An emergency stop or servo alarm occurs.
- A reset (external reset signal, reset & rewind signal, or reset key on the MDI panel) is issued.

By setting bit 0 (HBR) of parameter No. 7700, the release of the synchronization status by a reset can be suppressed.

- **Helical gear compensation**

When a helical gear is to be cut, compensation for the C-axis is needed according to the amount of travel along the Z-axis (third axis) (axial feed) and gear helix angle.

Helical gear compensation is performed by adding compensation pulses, calculated using the formula below, to the C-axis which is synchronized with the hob axis:

$$\text{Compensation angle} = \frac{Z \times \sin(P)}{\pi \times T \times Q} \times 360 \text{ (For metric input)}$$

or

$$\text{Compensation angle} = \frac{Z \times Q \times \sin(P)}{\pi \times T} \times 360 \text{ (For inch input)}$$

where

Compensation angle : Signed absolute value (deg)

Z : Amount of travel along the Z-axis after the specification of G81 (mm or inches)

Total amount of travel along the Z-axis in both automatic and manual modes

P : Signed gear helix angle (deg)

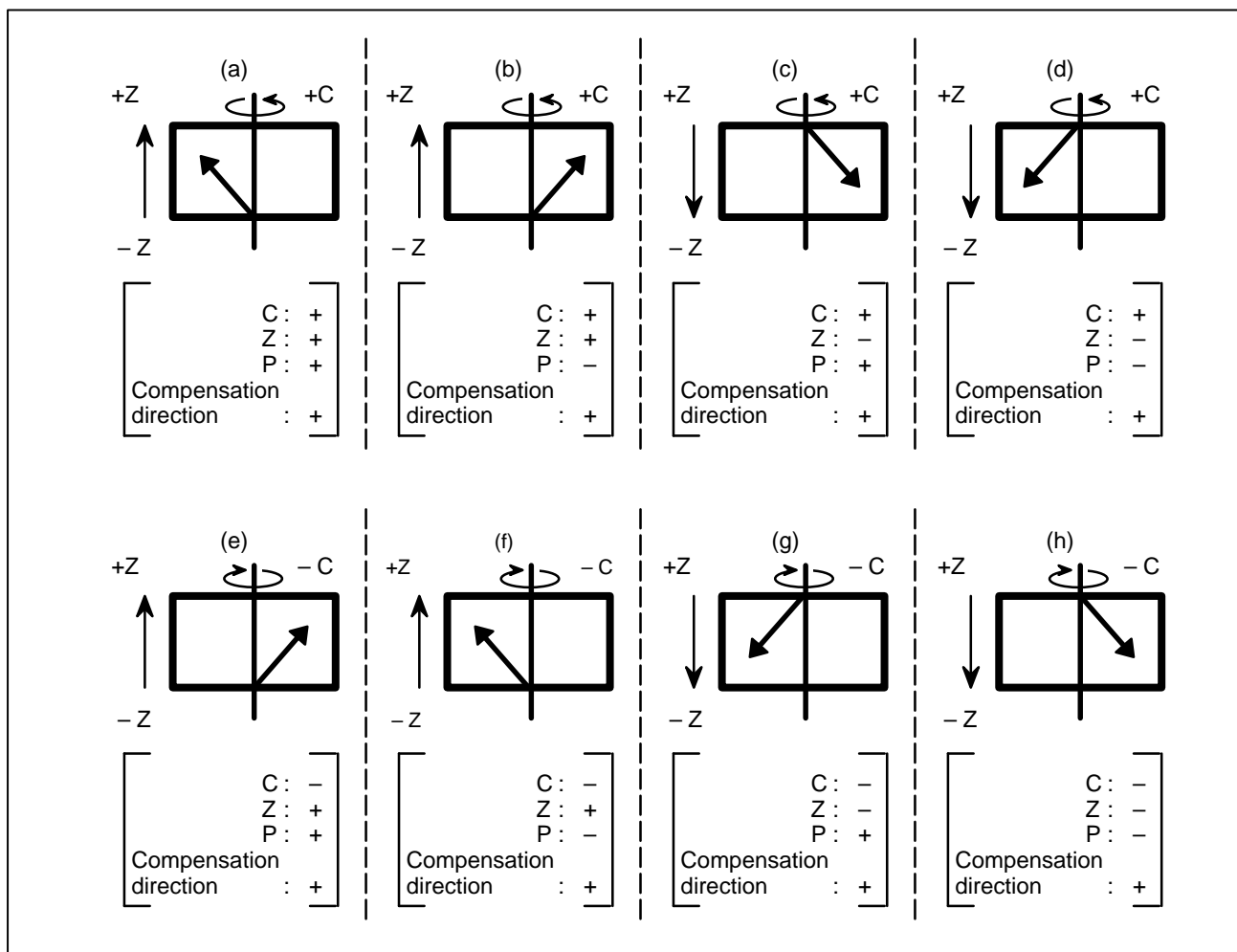
T : Number of teeth

Q : Module (mm) or diametral pitch (inch⁻¹)

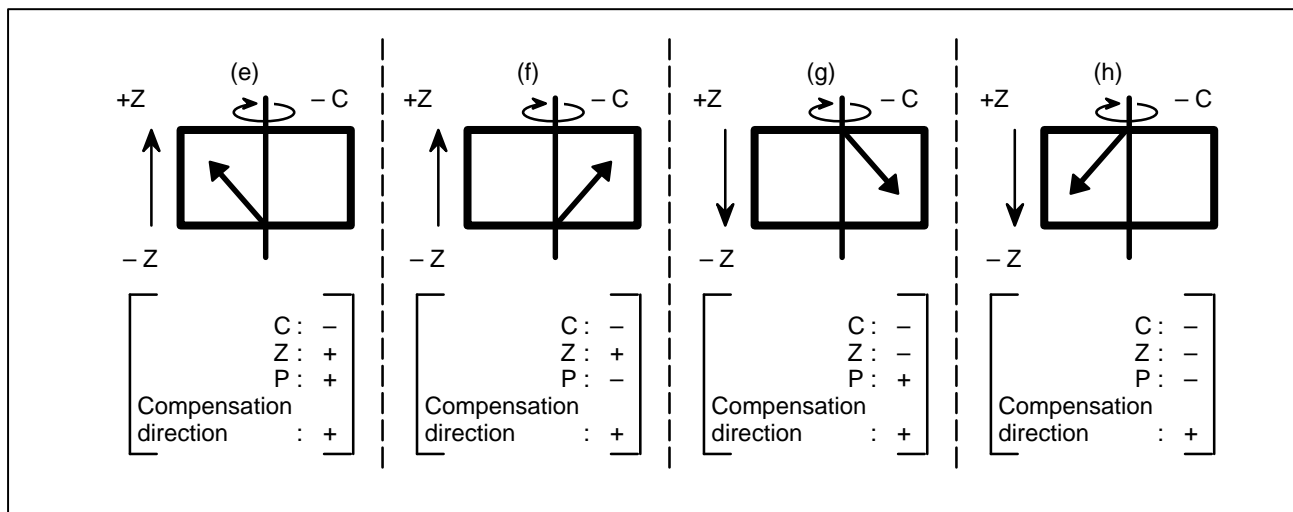
The values of P, T, and Q must be programmed.

• **Direction of helical gear compensation**

1 When bit 2 (HDR) of parameter No. 7700 = 1



2 When bit 2 (HDR) of parameter No. 7700 = 0 (Items (a) to (d) are the same as for 1.)



- **Setting the helical gear axial feed axis**

The Z-axis (axial feed axis) is usually the third axis. However, any axis can be set as the Z-axis by setting the corresponding parameter appropriately (parameter No. 7709).

- **C-axis servo delay compensation (G82, G83, G84)**

The servo delay is proportional to the speed of the hob axis. Therefore, in a cycle where rough machining and finish machining are performed at different hob axis speeds, compensation for the servo delay is required. The servo delay is calculated as follows:

$$E = \left\{ \left(\frac{F_c}{60} \right) \times \left(\frac{1}{K_s} + C * M + L \right) + \text{Sup} \right\} \times N$$

where

E	: C-axis servo delay compensation	... (deg)
F _c	: C-axis speed when G83 is specified	... (deg/min)
K _s	: Servo loop gain (LPGIN of parameter No. 1825)	... (sec ⁻¹)
C	: Delay incurred in the CNC	... (sec)
M	: Delay compensation magnification 1 in the CNC (SVCMP1 of parameter No. 7715)	
L	: Delay incurred by smoothing, as specified by parameter No. 7701	... (sec)
Sup	: Remaining pulse error caused by acceleration/deceleration	... (deg)
N	: C-axis servo delay compensation magnification 2 (SVCMP2 of parameter No. 7714)	

When the hob axis speed is changed, C-axis servo delay compensation is performed using the following two methods:

- Compensation is specified both before and after the speed is changed. Each time G83 is specified, compensation for the delay at that time is applied.
- Before the speed is changed, the servo delay is recorded. After the speed is changed, compensation for the difference between the recorded delay and that observed when the command is specified is performed.

The latter method, in which the compensation before speed change is recorded, can be used by setting bit 5 (DLY) of parameter No. 7701 to 1. This method, in comparison with that where the amount of compensation is not recorded, offers the advantage of processing being possible at higher speeds.

· **Method in which compensation for the delay when a command is specified is performed (G82, G83)**

G82: Cancels C-axis servo delay compensation.

G83: Executes C-axis servo delay compensation.

(Example)

G81 T__ L__ ; . . . Starts synchronization.

M03 S100 ; . . . Rotates the hob axis.

G04 P2000 ; . . . Dwell to assure constant hob axis rotation.

G01 G83 F__ ; . . . Performs C-axis delay compensation.

G01 X__ F__ ;

.

.

G82 ; . . . Cancels C-axis servo delay.

S200 ; . . . Changes the speed.

G04 P2000 ; . . . Dwell to assure constant hob axis rotation.

G01 G83 F__ ; . . . Performs C-axis delay compensation.

· **Method in which the delay before change is recorded (G82, G83, G84)**

G82: Cancels C-axis servo delay compensation.

G83: Performs compensation for the difference between the C-axis servo delay, observed when G83 is specified, and the delay recorded by G84.

G84: Records the C-axis servo delay observed when G84 is specified. (The recorded value remains as is until G81 is specified or another G84 is specified.)

(Example)

G81 T__ L__ ; . . . Starts synchronization.

M03 S100 ; . . . Rotates the hob axis.

G04 P2000 ; . . . Dwell to assure constant hob axis rotation.

G84 ; . . . Records the C-axis servo delay at the current speed.

G01 X__ F__ ;

.

.

.

S200 ; . . . Changes the speed.

G04 P2000 ; . . . Dwell to assure constant hob axis rotation

G01 G83 F__ ; . . . Performs C-axis servo delay compensation.

· **Notes**

- Specify the G83 block in G01 mode. Also, specify a feedrate using the F code.
- Once G83 has been specified, another G83 command cannot be specified until compensation is canceled by specifying G82, or C-axis synchronization is canceled.
- Specify G83 once a constant hob axis rotation speed has been achieved.

- **C-axis synchronous shift**
 - In C-axis servo delay compensation (G83), compensation is not applied to the integer part of the gear pitch. The compensation direction is opposite to that of the C-axis rotation.
 - C-axis handle interrupt

During synchronization between the hob axis and C-axis, manual handle interrupt can be performed for the C-axis. The C-axis is shifted by the amount of the handle interrupt.

For details of handle interrupts, refer to the relevant manual supplied by the machine tool builder.
 - Synchronous shift by programming

During synchronization between the hob axis and C-axis, the C-axis can be interrupted using G01. In this case, be careful not to exceed the maximum cutting speed.

Example: Hob shifting during synchronization
G01 Y__ C__ F__ ;
- **Manual setting of one-rotation signal**

When the rotation of the position coder is stopped, the position of the one-rotation signal is shifted in the CNC as if the one-rotation signal had been output with the position coder at the current position.

For details, refer to the relevant manual supplied by the machine tool builder.
- **Retract function**

In both automatic and manual operation mode, retract movement can be made over the distance specified by parameter No. 7741, along the axis set by bit 0 (RTRx) of parameter No. 7730.

For details, refer to the relevant manual supplied by the machine tool builder.

Limitations

- **Setting a rotation axis**

Set a rotation axis as the C-axis (workpiece axis). (Bit 0 (RoTx) of parameter No. 1006 = 1)
- **Gear ratio of the spindle and option coder**

The gear ratio of the spindle to the option coder must be 1. (Bits 0 and 1 of parameter No. 3706 = 0)

20.8 SIMPLE ELECTRIC GEAR BOX (G80, G81)

In the same way as with the hobbing machine function, to machine (grind/cut) a gear, the rotation of the workpiece axis connected to a servo motor is synchronized with the rotation of the tool axis (grinding wheel/hob) connected to the spindle motor. To synchronize the tool axis with the workpiece axis, an electric gear box (EGB) function is used for direct control using a digital servo system. With the EGB function, the workpiece axis can trace tool axis speed variations without causing an error, thus machining gears with great precision.

Some conditions must be satisfied for setting the workpiece axis and tool axis. For details, refer to the relevant manual provided by the machine tool builder.

Format

G81 T _ L _ Q _ P _ ;	Starts synchronization.
S _ M03 (or M04) ;	Starts tool axis rotation.
M05 ;	Stops tool axis rotation.
G80 ;	 Cancels synchronization.

T : Number of teeth (Specifiable range: 1 to 1000)

L : Number of hob threads
(Specifiable range: -21 to +21 with 0 excluded)

Q : Module or diametral pitch
Specify a module in the case of metric input.
(Unit: 0.00001 mm, Specifiable range: 0.01 to 25.0 mm)
Specify a diametral pitch in the case of inch input.
(Unit: 0.00001 inch⁻¹, Specifiable range: 0.01 to 25.0 inch⁻¹)

P : Gear helix angle
(Unit: 0.0001 deg, Specifiable range: -90.0 to 90.0 deg.)

* When specifying Q and P, the user can use a decimal point.

Explanations

• Synchronization control

1 Start of synchronization

When synchronization mode is set with G81, the synchronization switch of the EGB function is closed, and synchronization between the tool axis and workpiece axis starts. At this time, synchronization mode signal SYNMOD is turned on. During synchronization, the rotation of the tool axis and workpiece axis is controlled so that the relationship between T (number of teeth) and L (number of hob threads) can be maintained. Moreover, the synchronous relationship is maintained regardless of whether the operation is automatic or manual during synchronization.

G81 cannot be specified again during synchronization. Moreover, the specification of T, L, Q, and P cannot be modified during synchronization.

2 Start of tool axis rotation

When the rotation of the tool axis starts, the rotation of the workpiece starts so that the synchronous relationship specified in the G81 block can be maintained.

The rotation direction of the workpiece axis depends on the rotation direction of the tool axis. That is, when the rotation direction of the tool axis is positive, the rotation direction of the workpiece axis is also positive; when the rotation direction of the tool axis is negative, the rotation direction of the workpiece axis is also negative. However, by specifying a negative value for L, the rotation direction of the workpiece axis can be made opposite to the rotation direction of the tool axis.

During synchronization, the machine coordinates of the workpiece axis and EGB axis are updated as synchronous motion proceeds. On the other hand, a synchronous move command has no effect on the absolute and relative coordinates.

3 Termination of tool axis rotation

In synchronism with gradual stop of the tool axis, the workpiece axis is decelerated and stopped. By specifying the command below after the spindle stops, synchronization is canceled, and the EGB synchronization switch is opened. At this time, the synchronization mode signal (SYNMOD) is turned off.

4 Cancellation of synchronization

The position of the workpiece axis after travel during synchronization is reflected in the absolute coordinates when synchronization is canceled; from this point, absolute command programming is enabled for the workpiece axis. By setting bit 0 (HOBRST) of parameter No. 7700 to 0, synchronization can also be canceled upon reset.

* The synchronization mode is canceled by a servo alarm, PS000 alarm, or emergency stop.

• Helical gear compensation

When a helical gear is to be produced, the compensation of workpiece axis rotation is needed according to the travel distance on the Z-axis (axial feed).

Helical gear compensation is performed by adding compensation pulses calculated from the formula below to the workpiece axis:

$$\text{Compensation angle} = \frac{Z \times \sin(P)}{\pi \times T \times Q} \times 360 \text{ (For metric input)}$$

or

$$\text{Compensation angle} = \frac{Z \times Q \times \sin(P)}{\pi \times T} \times 360 \text{ (For inch input)}$$

where

Compensation angle: Signed absolute value (deg)

Z: Amount of travel on the Z-axis after the specification of G81 (mm or inch)

P: Signed gear helix angle (deg)

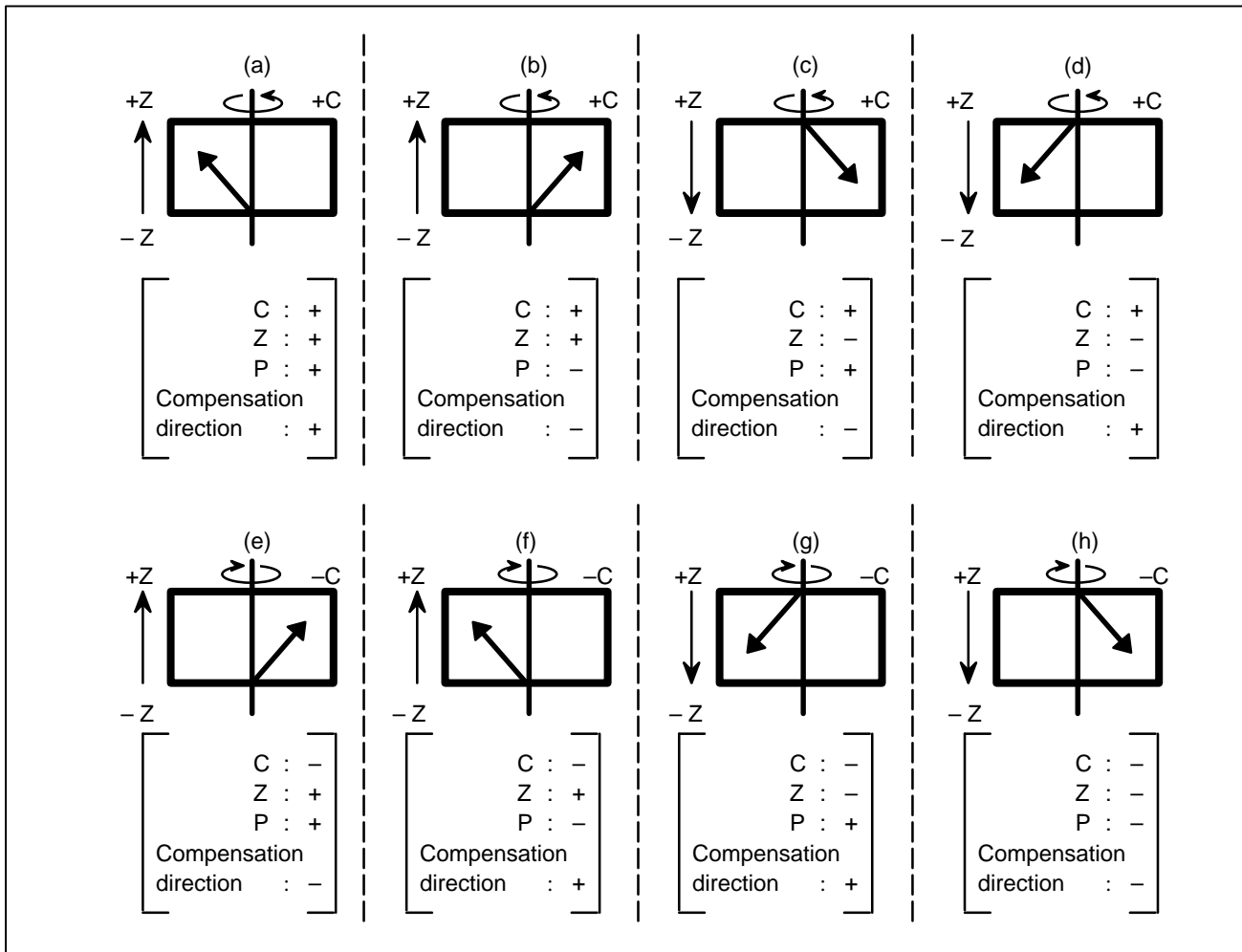
T: Number of teeth

Q: Module (mm) or diametral pitch (inch⁻¹)

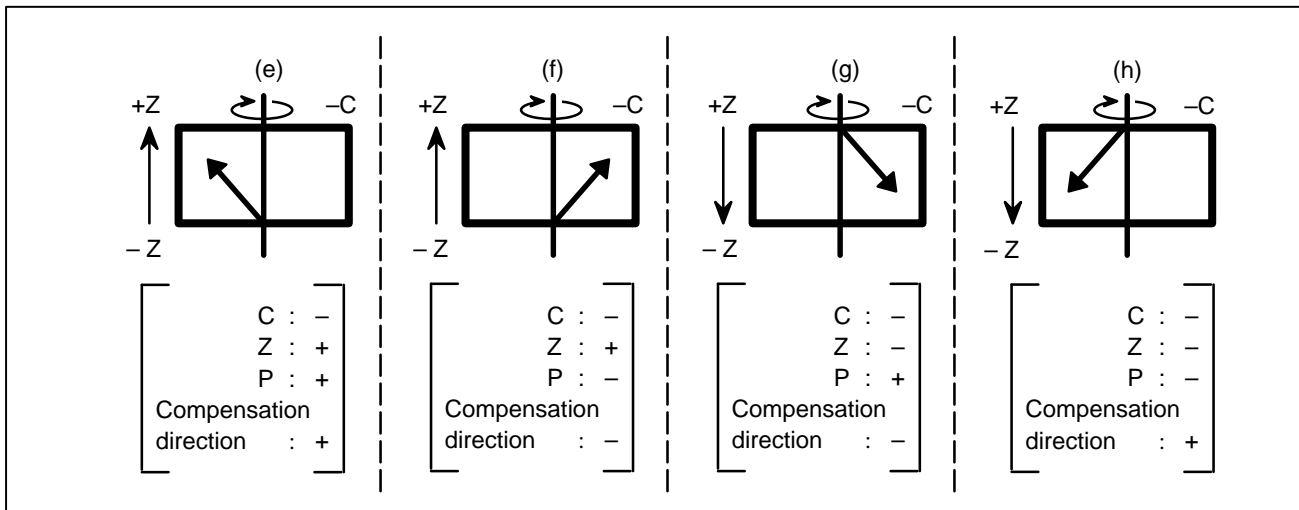
The values of P, T, and Q are to be programmed.

• **Direction of helical gear compensation**

1 When bit 2 (HDR) of parameter No. 7700 = 1



2 When bit 2 (HDR) of parameter No. 7700 = 0 (Items (a) to (d) are the same as for 1.)



- **Coordinates in helical compensation**
In helical compensation, the machine coordinates and absolute coordinates of the workpiece axis (4th axis) are updated by the amount of helical compensation.
- **Retraction**
By turning on the retract signal RTRCT (on a rising edge) in automatic operation mode or manual operation mode, a retract movement can be made over the distance specified in parameter No. 7741 on the axis set in bit 0 (RTRx) of parameter No. 7730. Upon completion of retract operation, the retract completion signal RTRCTF is output.
- **Feedrate at retraction**
For retract operation, the feedrate specified in parameter No. 7740 is used. During retract operation, the feedrate override capability is disabled.
- **Retraction during automatic operation**
When the retract signal is turned on in automatic operation, retract operation is performed, and automatic operation is stopped at the same time.
- **Synchronization coefficient**
A synchronization coefficient is internally represented using a fraction (K2/K1) to eliminate an error. The formula below is used for calculation. (α, β : Number of detector pulses per rotation of the tool axis, and number of detector pulses per rotation of the workpiece axis (parameter Nos. 7772 and 7773), respectively)

$$\text{Synchronization coefficient} = \frac{K2}{K1} = \frac{L}{T} \times \frac{\beta}{\alpha}$$

In the formula above, K2/K1 is obtained by reducing the right side to lowest terms, but K1 and K2 must satisfy the following restriction:

$$\begin{array}{rcccl} -2147483648 & \leq & K2 & \leq & -2147483647 \\ 1 & \leq & K1 & \leq & 65535 \end{array}$$

When this restriction is not satisfied, the PS181 alarm is issued when G81 is specified.

- **Manual handle interrupt**
During synchronization, a manual handle interrupt can be used for the workpiece axis and other servo axes.
- **Move command during synchronization**
During synchronization, a move command can be programmed for the workpiece axis and other servo axes. Note, however, that incremental command programming for cutting feed must be used to specify a workpiece axis move command.

Limitations

- **Feed hold during retraction**
For retract movement, the feed hold capability is disabled.
- **Retraction when alarm is issued**
This function does not include a retract function used when an alarm is issued.
- **Rapid traverse during synchronization**
In synchronization mode, a cutting feedrate can be specified for the workpiece axis (4th axis). Rapid traverse cannot be specified using G00.
- **Maximum speed**
The maximum speeds of the tool axis and workpiece axis depend on the detectors used.
- **G code command during synchronization**
During synchronization, G00, G28, G27, G29, G30, G53, G20, and G21 cannot be specified.
- **Drilling canned cycle**
When this function is used, the drilling canned cycle cannot be used.

Examples

O1000 ;	
N0010 M19 ;	Performs tool axis orientation.
N0020 G28 G91 C0 ;	Performs reference position return operation of the workpiece axis.
N0030 G81 T20 L1 ;	Starts synchronization between the tool axis and workpiece axis. (The workpiece axis rotates 18° when the tool axis makes one rotation.)
N0040 S300 M03 ;	Rotates the tool axis at 300 rpm.
N0050 G01 X____ F____ ;	Makes a movement on the X-axis (for cutting).
N0060 G01 Z____ F____ ;	Makes a movement on the Z-axis (for machining).
-----;	
-----;	
N0100 G01 X____ F____ ;	Makes a movement on the X-axis (for retraction).
N0110 M05 ;	Stops the tool axis.
N0120 G80 ;	Cancels synchronization between the tool axis and workpiece axis.
N0130 M30 ;	

20.9 RETREAT AND RETRY FUNCTIONS

The retreat and retry functions incorporate those functions that are needed to enable retreat and retry operations with a PMC and custom macros. Even if machining is interrupted by a reset or emergency stop, the tool can be returned from the interruption point (machining retreat function) to restart machining from the start block of the interrupted machining (machining retry function) easily.

The retreat and retry functions consist of the functions below.

- (1) Management of machining cycles by means of sequence numbers
 - Machining cycle management is performed using the following sequence numbers:
 - N7000 to N7998: Machining start point
 - N7999: Clearing of data to perform machining return or retry operation
(Until N7999 is specified, data is not cleared to perform machining return or restart operation.)
 - N8000 to N8999: Machining cycle start point
 - N9000 to N9999: Machining cycle end point
- (2) Saving of position information and modal information to custom macro variables at a machining start point and machining cycle start point
- (3) Rigid tapping return function
- (4) Restarting of machining at a machining start point or machining cycle start point

Format

Create a machining program in the format described below.

```

O0001 ;
(For an ordinary machining cycle)
N7000..... (1) ----- Machining start point
.....
N8000..... (2) ..: Machining cycle
N9000..... (3) ..:
N8010..... ..: Machining cycle
N9010..... ..:
.....
N7999..... (4) ----- Clears machining data
N7100
(For a drilling canned cycle)
N7010..... ----- Machining start point

N8010..... ----- Machining cycle
N8020..... ----- Machining cycle
.....
N7020..... ----- Machining start point
.....
M30
    
```


(1) After specifying positioning at a machining start point, specify a sequence number from 7000 to 7998 in a block where various preparatory functions (M, S, and T) for machining cycles are specified. The start point of a block where a sequence number from 7000 to 7998 is specified is regarded as a machining start point. The absolute coordinates of the point are stored together with the program number and sequence number in macro variables. The M code specified in the block is stored as a machining type M code in a macro variable.

(2) In a block for starting actual machining (machining cycle) such as cutting and drilling, specify a sequence number from 8000 to 8999. The start point of a block where a sequence number from 8000 to 8999 is specified is regarded as a machining cycle start point. The absolute coordinates of the point are stored together with the sequence number in macro variables. The S/F codes and G codes of group 5 (G94/G95) of the block are also stored in macro variables.

When a sequence number from 8000 to 8999 is specified, the macro variable used for the hole bottom reach flag (described later) is cleared.

When a drilling canned cycle is used, the position stored based on a sequence number from 8000 to 8999 is not the hole position but the position where the drilling canned cycle is specified.

(3) Specify a sequence number from 9000 to 9999 in a block for ending the machining cycle. When a sequence number from 9000 to 9999 is specified, the specification of a cycle end point is assumed; the macro variable used for the hole bottom reach flag is set.

The set flag is cleared when a sequence number from 8000 to 8999 is specified.

When a drilling canned cycle is used, the use of a sequence number from 9000 to 9999 cannot be specified. So, when the drilling canned cycle is completed, the macro variable used for the hole bottom reach flag is directly set.

(4) When the sequence number 7999 is specified, the data stored in the macro variables is cleared. This is to indicate the end of one machining operation, and to prevent the workpiece from being damaged even if a restart command is inadvertently specified to return the tool to the previously stored position.

A restart command is ignored even if specified when the data stored in the macro variables has been cleared.

Explanations

- **Retreat function**

Each machine tool builder is to create a retreat function program, which is started from the PMC by using a workpiece number search capability or program number search capability. For detailed information, refer to the relevant manual provided by each machine tool builder. A machining start point or machining cycle start point is stored in a macro variable, and therefore can be used as required. When retreat operation varies from one machining cycle to another, specify an M function for each machining cycle. An M function is stored as a machining type M code in a macro variable. So, retreat operation can be specified for each machining cycle by referencing each macro variable in the retreat program.

- **Retry function**

When the restart of machining is specified from the PMC, the retry function moves the execution pointer of the machining program to one of the following:

A. Last machining start point executed

B. Last cycle start point executed

(If machining operation such as cutting and drilling is interrupted, the pointer is moved to this point when the machining is not completed.)

C. Cycle start point following the last cycle start point executed

(If machining operation such as cutting and drilling is interrupted, the pointer is moved to this point when the machining is completed.)

Then, when the cycle start button is set to on, machining is restarted where the cursor is placed. This function is implemented using the program restart function. For information about restrictions, see the description of the restart of programs in the part for operations.

When a miscellaneous function for the restart of machining is to be specified after the execution pointer of the machining program is moved to a desired restart block with the retry function, display the restart screen, and specify required commands in the MDI mode.

When machining is to be restarted at the cycle start point following the last cycle start point executed, P/S alarm No. 5066 is issued if a machining start point is detected before the next cycle start point is found.

- **Rigid tapping return**

If rigid tapping operation is interrupted by a reset or emergency stop, a movement can be made on the tapping axis to the initial point or point R in synchronism with the spindle according to the rigid tapping command information in the machining program. For this purpose, execute the command below in the retreat program.

The rigid tapping command is a one-shot code.

G30 P99 M29 S_rpm ;

(Example)

Machining program

```
.....  
N7000 M29 S1000 ;  
N8000 G84 X20. Y20. R-10. Z-30. F500 ;  
N8010 X50. Y50. ;  
N8020 X100. Y100 . ;  
      G80 ;  
.....
```

Retreat program

```
.....  
IF    [#mmm NE 29 ] GOTO 1000 ;  
G30 P99 M29 S1000 ;  
G00 Z-10. ;  
G00 X#xxx Y#yyy Z#zzz ;  
GOTO 2000 ;  
.....
```

NOTE

- 1 Rigid tapping cannot be restarted from an intermediate hole. Be sure to restart rigid tapping at the rigid tapping start block (M29).
- 2 If a value other than 0 is specified in parameter No. 5210, specify the value in place of M29 in the program above.

● **Macro variables**

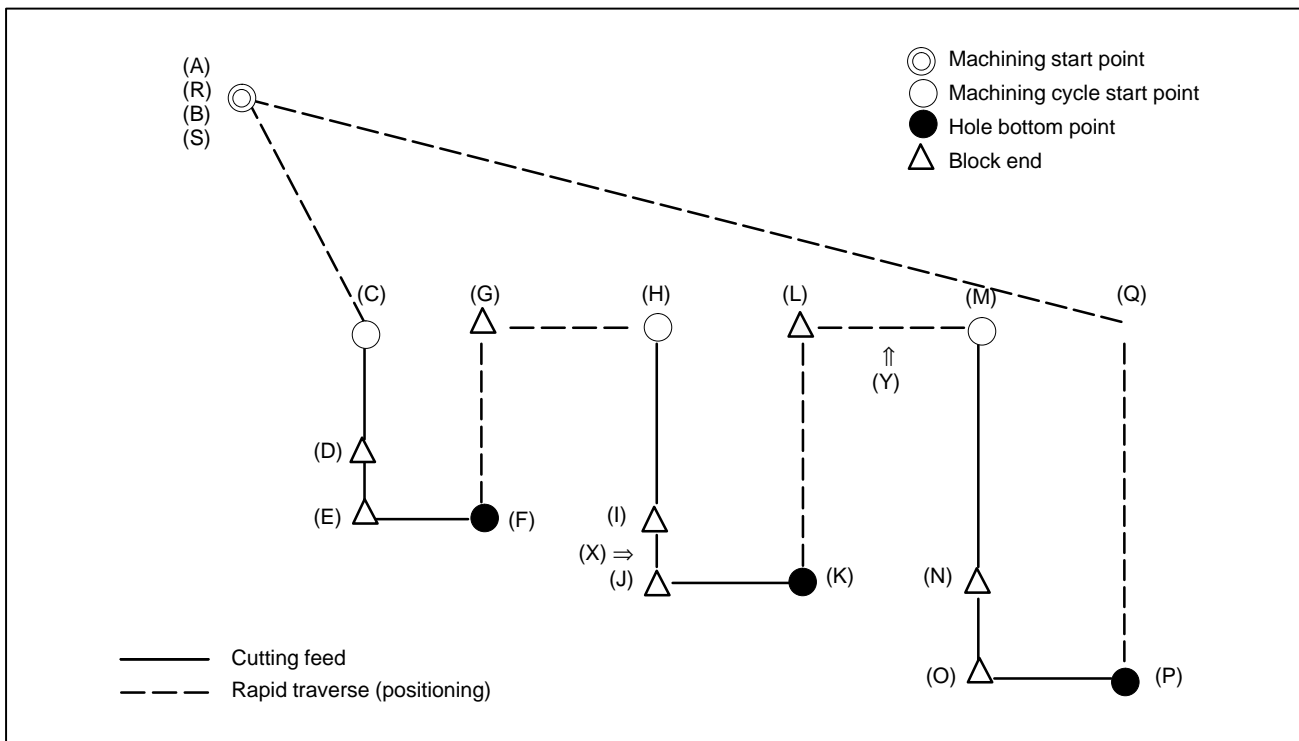
Information required for the machining return and restart functions is stored in macro variables. The start number of those variables is to be set in parameter No. 7351. Twenty-five successive variables starting with the variable specified in the parameter are used.

# ? 00		Running program number
01		Machining start point sequence number
02		Machining start point (for 8 axes)
	
	
09		
10		Machining type M code
11		Machining cycle start point sequence number
12		Machining cycle start point (for 8 axes)
	
	
19		
20		F code at machining cycle start point
21		S code at machining cycle start point
22		Machining cycle hole bottom reach flag
23		G codes of group 05
24		(Reserved)

Examples

```

O1000 ;
.....
G00 X100. Y100. Z100. ; (A)
N7010 M101 T10 S100 ; (B)
G00 X0. Y0. Z0. ; (C)
N8010 G01 Z- 20. F100 ; (D)
Z- 40. ; (E)
Y20. ; (F)
N9010 G00 Z0. ; (G)
X20. ; (H)
N8020 G01 Z- 40. F200 ; (I)
Z- 60. ; (J)
Y40. ; (K)
N9020 G00 Z0. ; (L)
X40. ; (M)
N8030 G01 Z- 80. F300 ; (N)
Z- 100. ; (O)
Y60. ; (P)
N9030 G00 Z0. ; (Q)
X100. Y100. Z100. ; (R)
N7020 M102 T11 S200 ; (S)
.....
(T)
    
```



21

TWO-PATH CONTROL FUNCTION



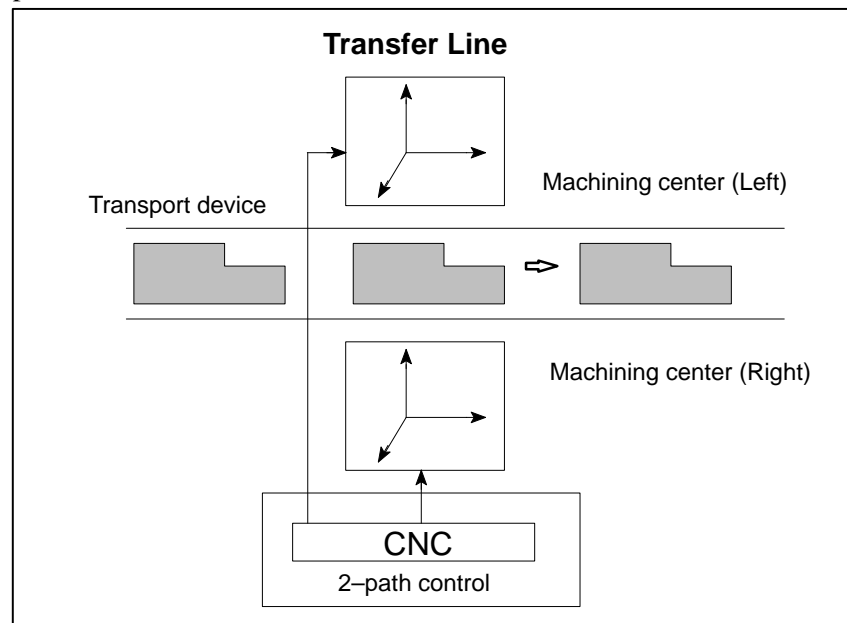
21.1 GENERAL

- **Controlling two path independently at the same time**

The two-path control function is designed for use on a machining center where two systems are operated independently to simultaneously perform cutting.

The operations of two path are programmed independently of each other, and each program is stored in program memory for each path. When automatic operation is to be performed, each path is activated after selecting a program for machining with path 1 and a program for machining with path 2 from the programs stored in program memory for each path. Then the programs selected for the paths are executed independently at the same time. When path 1 and path 2 need to wait for each other during machining, the waiting function is available (Section 21.2)

Just one MDI is provided for the two paths. Before operation and display on the MDI, the path selection signal is used to switch between the two paths.



WARNING

Simultaneous operation of the two paths or the operation of only a single tool post can be selected by pressing a key on the machine operator's panel. For details, refer to the manual supplied by the machine tool builder.

NOTE

- 1 An M code for waiting must always be specified in a single block.
- 2 If one path is waiting because of an M code for waiting specified, and a different M code for waiting is specified with the other path, an P/S alarm (No. 160) is raised, In this case, both paths stop operation.
- 3 PMC-CNC interface
Unlike other M codes, the M code for waiting is not output to the PMC.
- 4 Operation of a single path
If the operation of a single path is required, the M code for waiting need not be deleted. By using the NOWT signal to specify that waiting be ignored (G0063, #1), the M code for waiting in a machining program can be ignored. For details, refer to the manual supplied by the machine tool builder.

21.3 MEMORY COMMON TO PATH

A machine with two paths have different custom macro common variables and tool compensation memory areas for path 1 and 2. Paths 1 and 2 can share the custom macro common variables and tool compensation memory areas provided certain parameters are specified accordingly.

Explanations

- **Custom macro common variables**

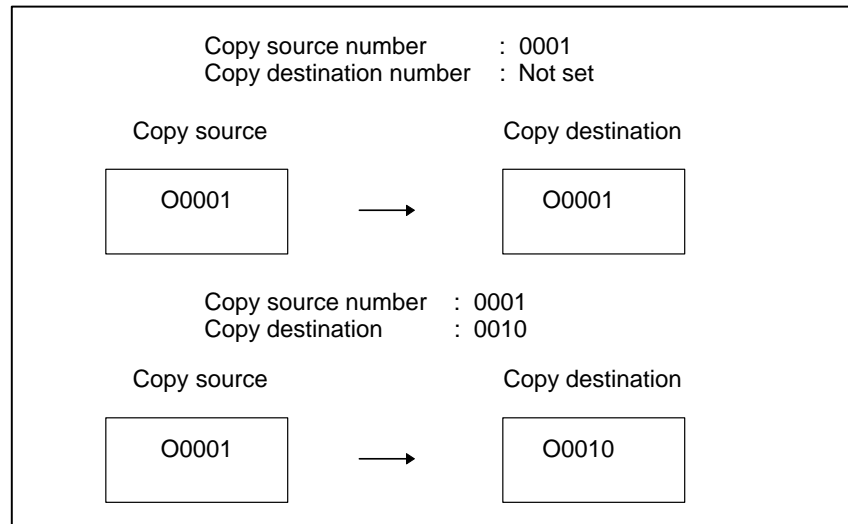
Paths 1 and 2 can share all or part of custom macro common variables #100 to #149 and #500 to #531, provided parameters 6036 and 6037 are specified accordingly. (The data for the shared variables can be written or read from either path.) See Section 15.1 of Part II.

21.4 COPYING A PROGRAM BETWEEN TWO PATHS

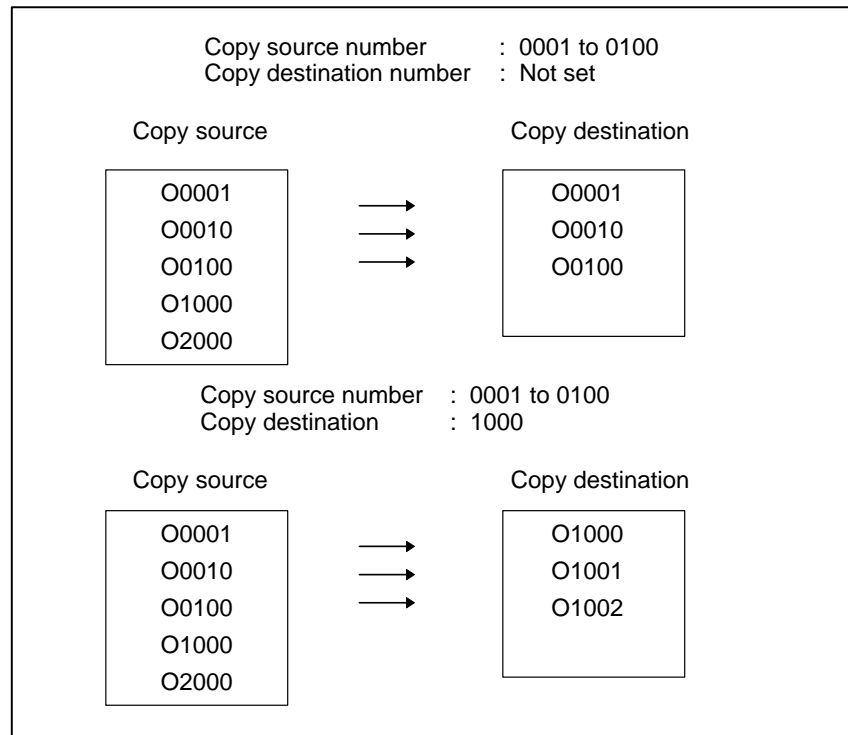
In a CNC supporting two-path control, specified machining programs can be copied between the two paths by setting bit 0 (PCP) of parameter No. 3206 to 1. A copy operation can be performed by specifying either a single program or a range. For information about operations, see Section 9.10 in Part III.

Explanations

- Single-program copy



- Specified-range copy



III. OPERATION

1

GENERAL



1.1 MANUAL OPERATION

Explanations

- **Manual reference position return**
(See Section III-3.1)

The CNC machine tool has a position used to determine the machine position.

This position is called the reference position, where the tool is replaced or the coordinate are set. Ordinarily, after the power is turned on, the tool is moved to the reference position.

Manual reference position return is to move the tool to the reference position using switches and pushbuttons located on the operator's panel.

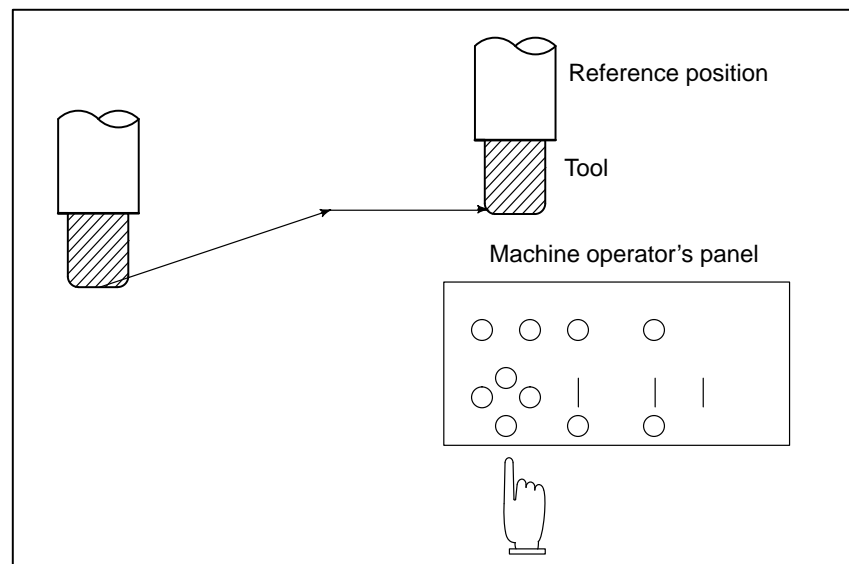


Fig.1.1 (a) Manual reference position return

The tool can be moved to the reference position also with program commands.

This operation is called automatic reference position return (See Section II-6).

- **The tool movement by manual operation**

Using machine operator's panel switches, pushbuttons, or the manual handle, the tool can be moved along each axis.

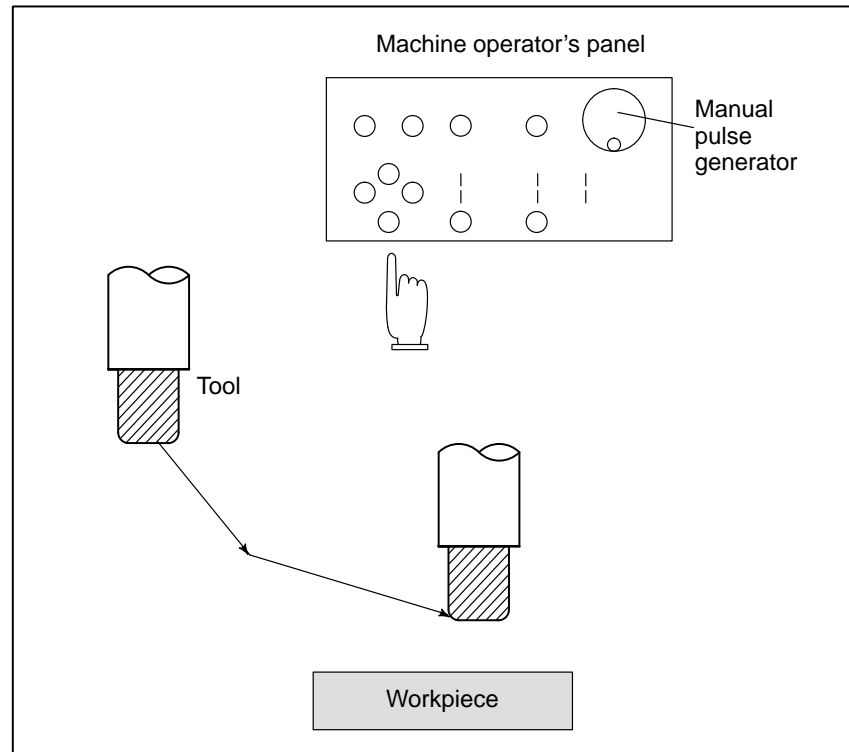


Fig.1.1 (b) The tool movement by manual operation

The tool can be moved in the following ways:

- (i) Jog feed (See Section III-3.2)
The tool moves continuously while a pushbutton remains pressed.
- (ii) Incremental feed (See Section III-3.3)
The tool moves by the predetermined distance each time a button is pressed.
- (iii) Manual handle feed (See Section III-3.4)
By rotating the manual handle, the tool moves by the distance corresponding to the degree of handle rotation.

1.2 TOOL MOVEMENT BY PROGRAMING – AUTOMATIC OPERATION

Automatic operation is to operate the machine according to the created program. It includes memory, MDI and DNC operations. (See Section III-4).

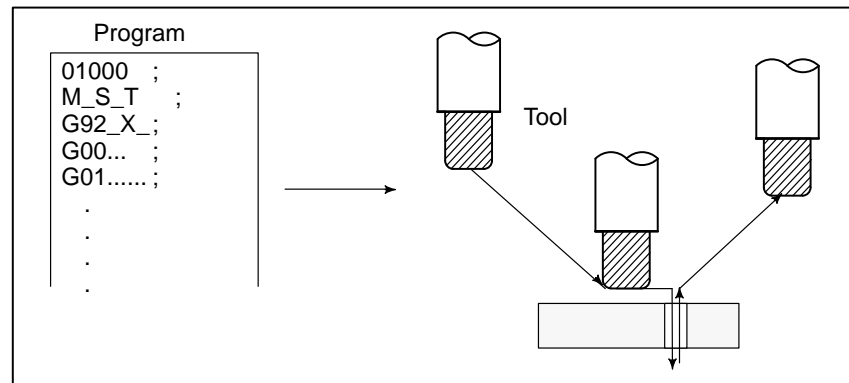


Fig.1.2 (a) Tool Movement by Programming

Explanations

- Memory operation

After the program is once registered in memory of CNC, the machine can be run according to the program instructions. This operation is called memory operation.

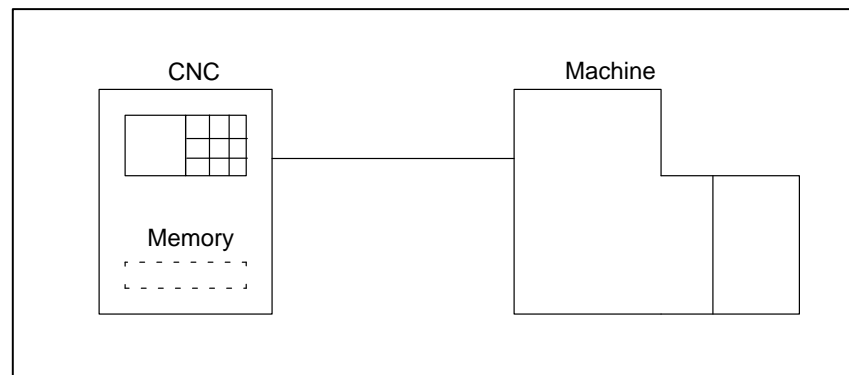


Fig.1.2 (b) Memory Operation

- MDI operation

After the program is entered, as an command group, from the MDI keyboard, the machine can be run according to the program. This operation is called MDI operation.

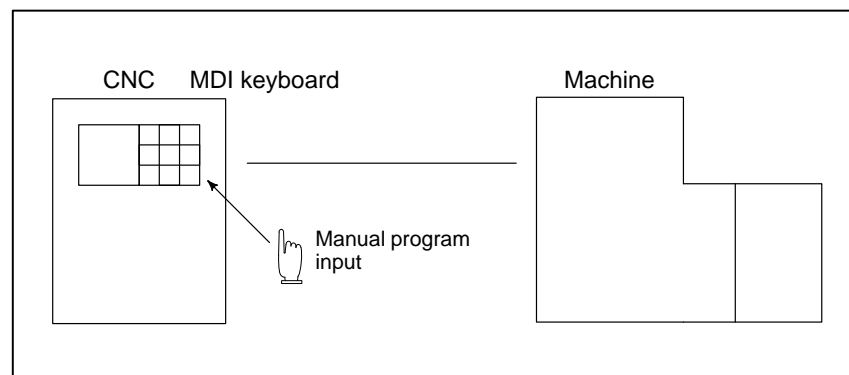


Fig.1.2 (c) MDI operation

- DNC operation

In this mode of operation, the program is not registered in the CNC memory. It is read from the external input/output devices instead. This is called DNC operation. This mode is useful when the program is too large to fit the CNC memory.

1.3 AUTOMATIC OPERATION

Explanations

- **Program selection**

Select the program used for the workpiece. Ordinarily, one program is prepared for one workpiece. If two or more programs are in memory, select the program to be used, by searching the program number (Section III-9.3).

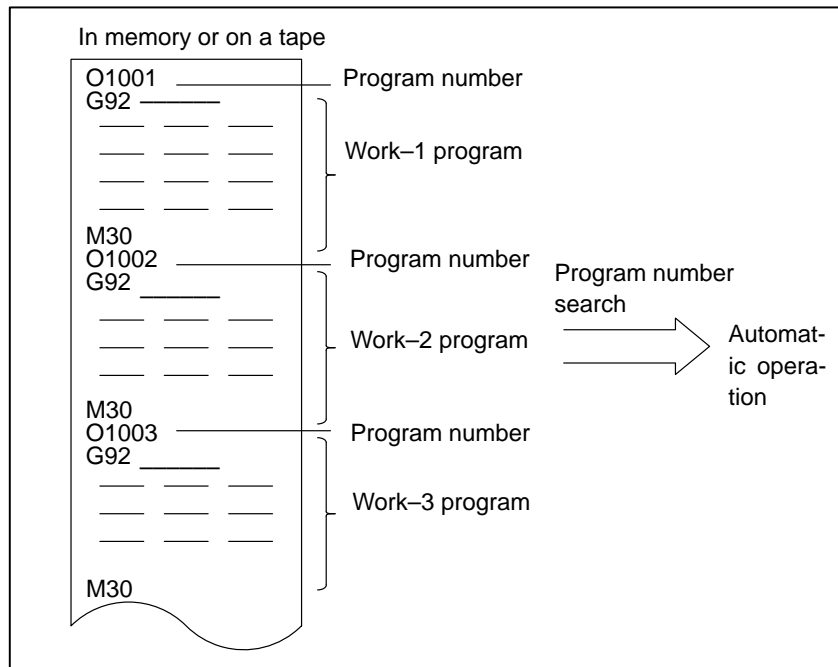


Fig.1.3 (a) Program Selection for Automatic Operation

- **Start and stop**
(See Section III-4)

Pressing the cycle start pushbutton causes automatic operation to start. By pressing the feed hold or reset pushbutton, automatic operation pauses or stops. By specifying the program stop or program termination command in the program, the running will stop during automatic operation. When one process machining is completed, automatic operation stops.

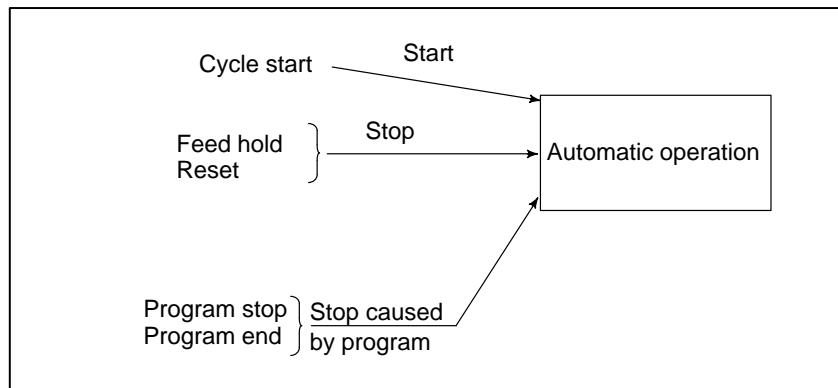


Fig.1.3 (b) Start and Stop for Automatic Operation

- **Handle interruption**
(See Section III-4.8)

While automatic operation is being executed, tool movement can overlap automatic operation by rotating the manual handle.

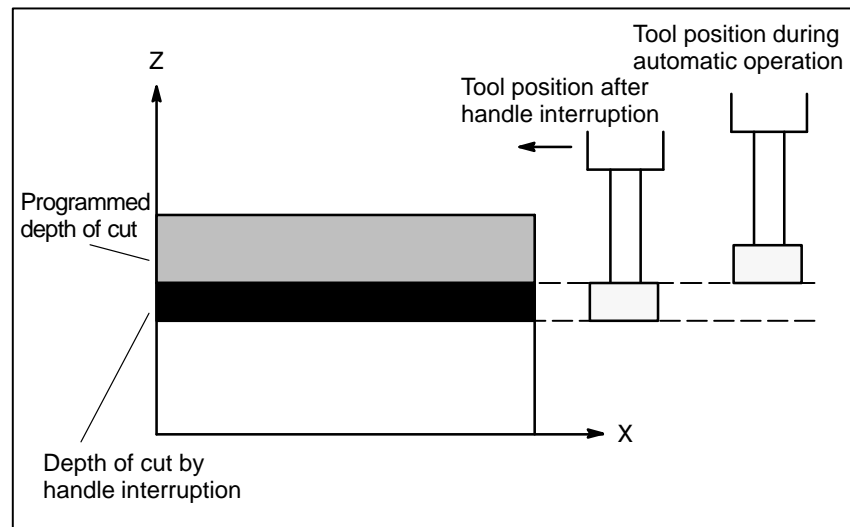


Fig.1.3 (c) Handle Interruption for Automatic Operation

1.4 TESTING A PROGRAM

Before machining is started, the automatic running check can be executed. It checks whether the created program can operate the machine as desired. This check can be accomplished by running the machine actually or viewing the position display change (without running the machine) (See Section III-5).

1.4.1 Check by Running the Machine

Explanations

- **Dry run (See Section III-5.4)**

Remove the workpiece, check only movement of the tool. Select the tool movement rate using the dial on the operator's panel.

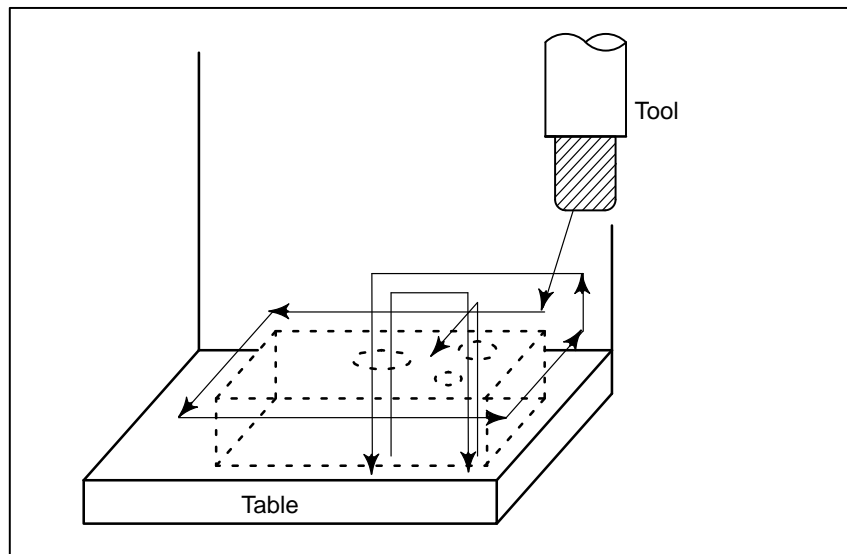


Fig.1.4 (a) Dry run

- **Feedrate override (See Section III-5.2)**

Check the program by changing the feedrate specified in the program.

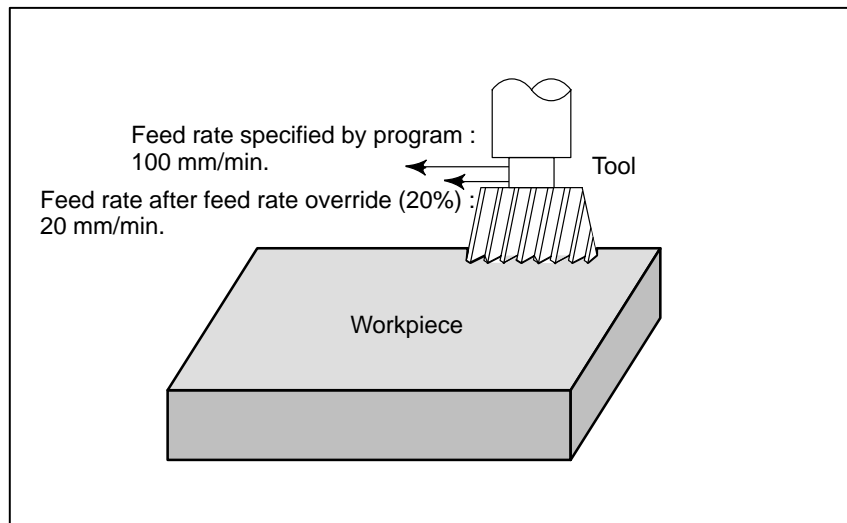


Fig1.4 (b) Feedrate Override

- **Single block**
(See Section III-5.5)

When the cycle start pushbutton is pressed, the tool executes one operation then stops. By pressing the cycle start again, the tool executes the next operation then stops. The program is checked in this manner.

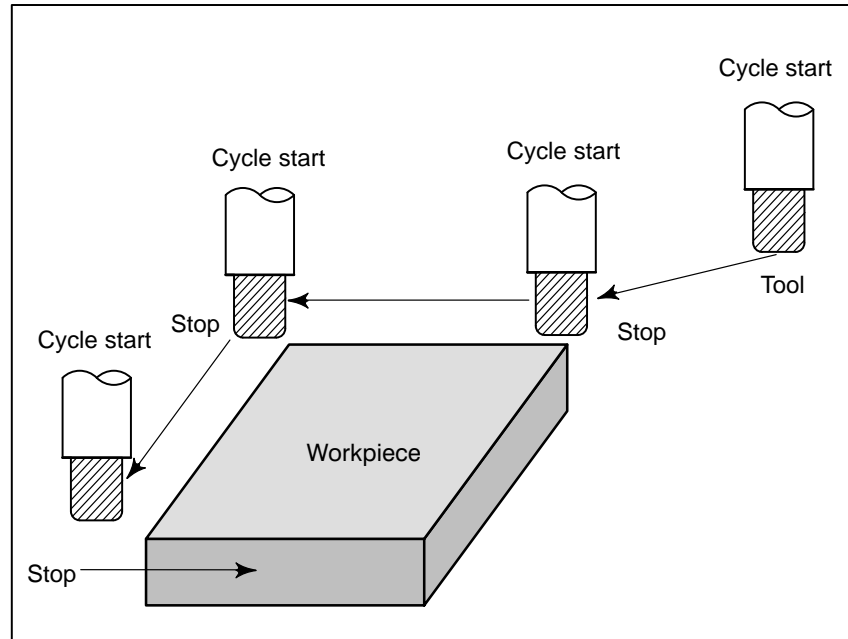


Fig.1.4 (c) Single Block

1.4.2 How to View the Position Display Change without Running the Machine

Explanations

- **Machine lock**
(See Sections III-5.1)

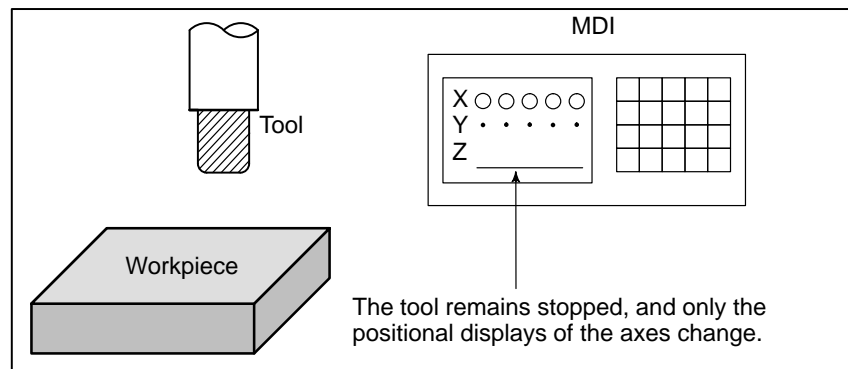


Fig1.4 (d) Machine Lock

- **Auxiliary function lock**
(See Section III-5.1)

When automatic running is placed into the auxiliary function lock mode during the machine lock mode, all auxiliary functions (spindle rotation, tool replacement, coolant on/off, etc.) are disabled.

1.5 EDITING A PART PROGRAM

After a created program is once registered in memory, it can be corrected or modified from the MDI panel (See Section III-9). This operation can be executed using the part program storage/edit function.

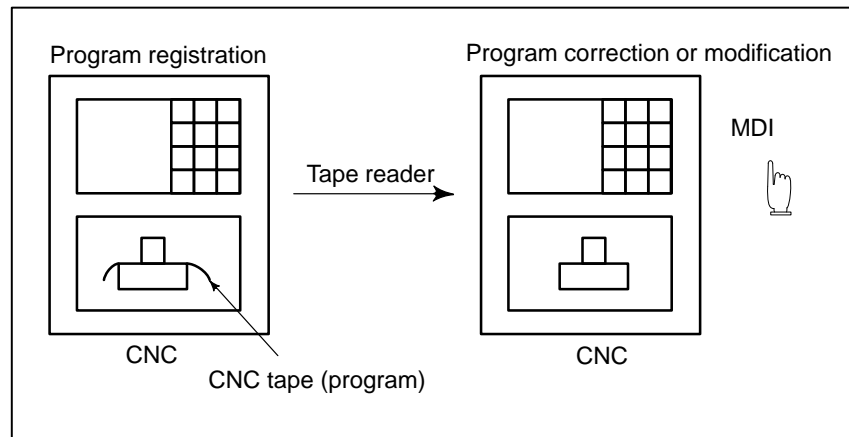


Fig.1.5 (a) Part Program Editing

1.6 DISPLAYING AND SETTING DATA

The operator can display or change a value stored in CNC internal memory by key operation on the MDI screen (See III-11).

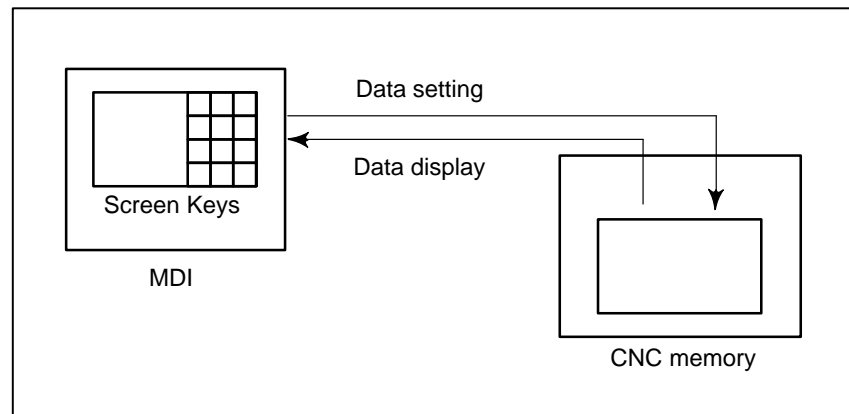


Fig.1.6 (a) Displaying and Setting Data

Explanations

- Offset value

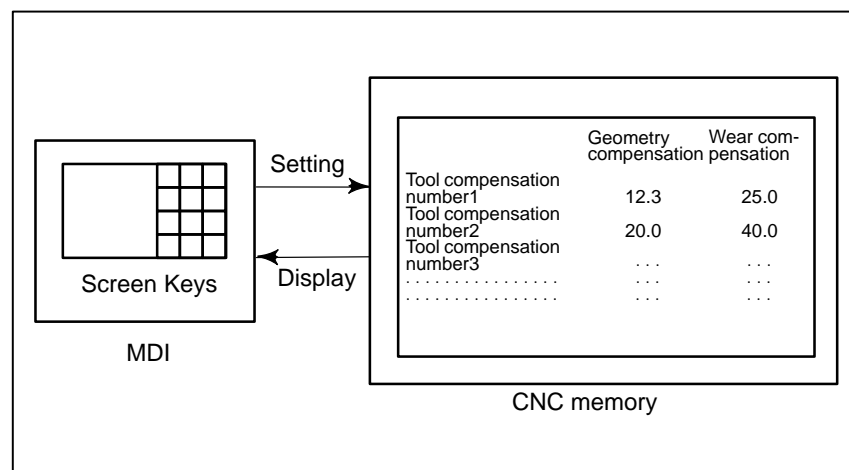


Fig.1.6 (b) Displaying and Setting Offset Values

The tool has the tool dimension (length, diameter). When a workpiece is machined, the tool movement value depends on the tool dimensions. By setting tool dimension data in CNC memory beforehand, automatically generates tool routes that permit any tool to cut the workpiece specified by the program. Tool dimension data is called the offset value (See Section III-11.4.1).

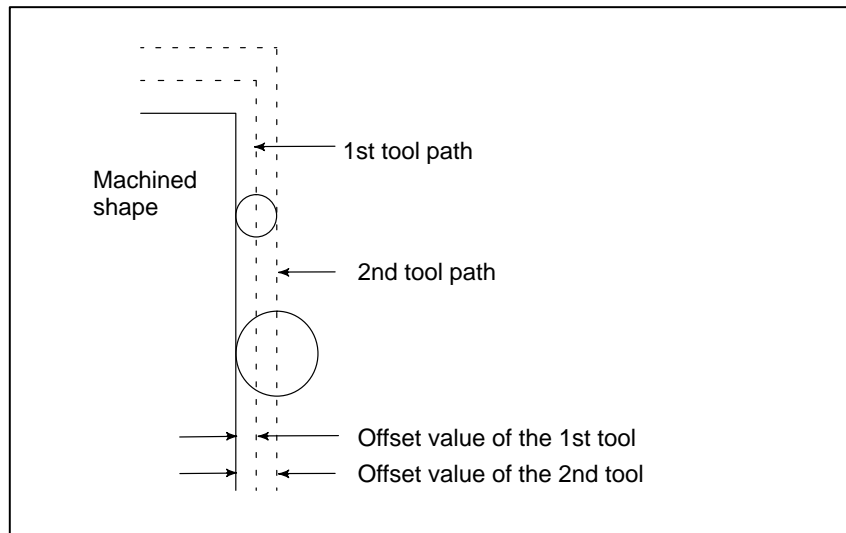


Fig.1.6 (c) Offset Value

• **Displaying and setting operator's setting data**

Apart from parameters, there is data that is set by the operator in operation. This data causes machine characteristics to change.

For example, the following data can be set:

- Inch/Metric switching
- Selection of I/O devices
- Mirror image cutting on/off

The above data is called setting data (See Section III-11.4.3).

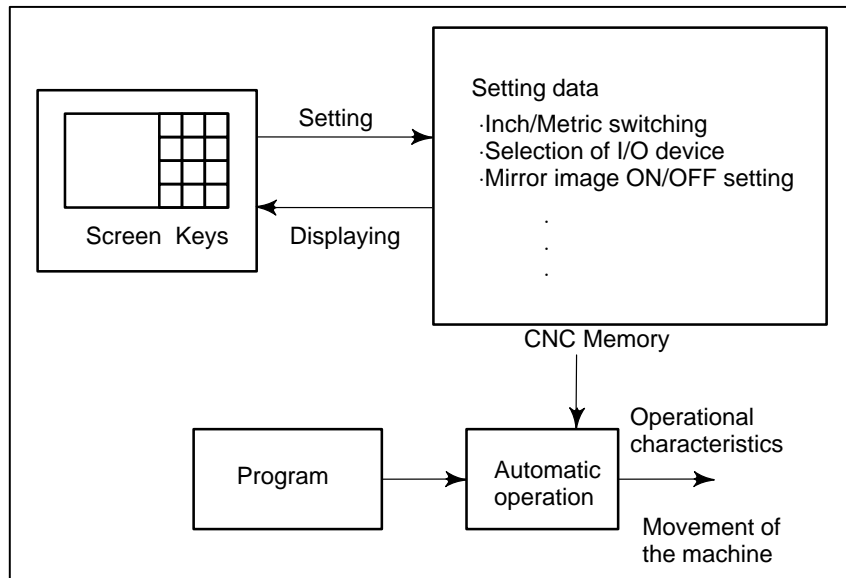


Fig.1.6 (d) Displaying and Setting Operator's setting data

● **Displaying and setting parameters**

The CNC functions have versatility in order to take action in characteristics of various machines.

For example, CNC can specify the following:

- Rapid traverse rate of each axis
- Whether increment system is based on metric system or inch system.
- How to set command multiply/detect multiply (CMR/DMR)

Data to make the above specification is called parameters (See Section III-11.5.1).

Parameters differ depending on machine tool.

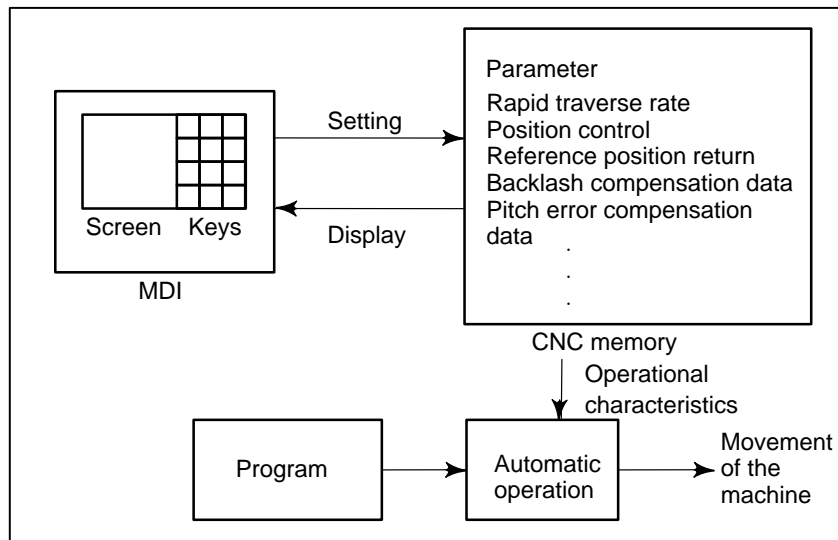


Fig.1.6 (e) Displaying and setting parameters

● **Data protection key**

A key called the data protection key can be defined. It is used to prevent part programs, offset values, parameters, and setting data from being registered, modified, or deleted erroneously (See Section III-11).

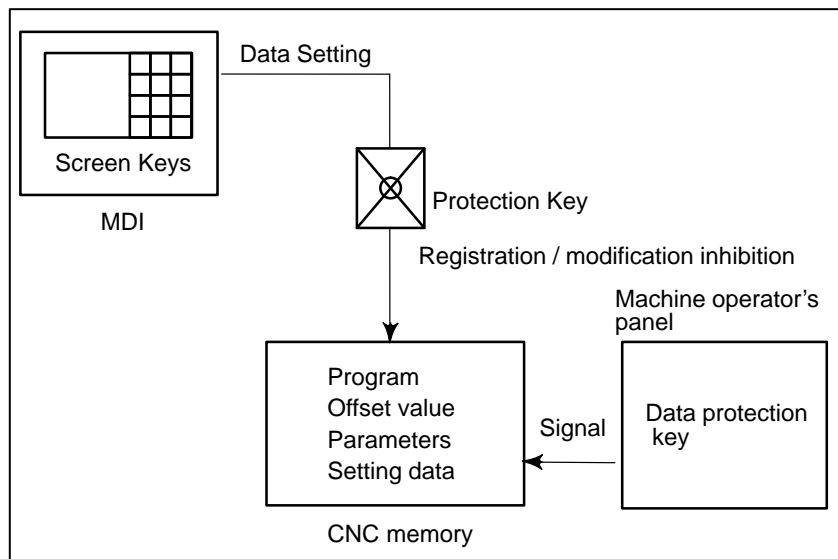
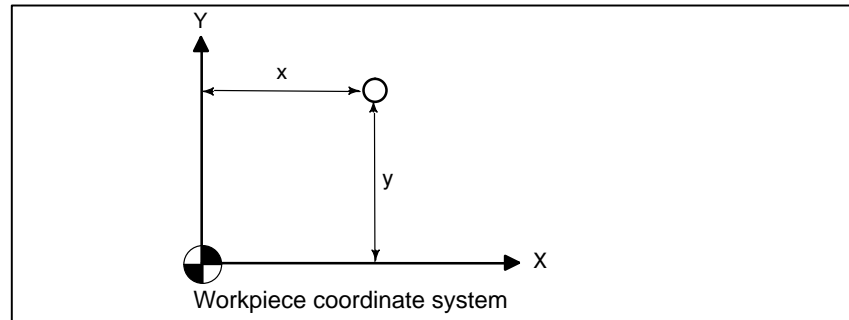


Fig.1.6 (f) Data Protection Key

1.7.2 Current Position Display

The current position of the tool is displayed with the coordinate values. The distance from the current position to the target position can also be displayed. (See Section III-11.1.1 to 11.1.3)



ACTUAL POSITION (ABSOLUTE)		O0003 N0003
X	150.000	
Y	300.000	
Z	100.000	
PART COUNT 30		
RUN TIME	0H41M	CYCLE TIME 0H 0M22S
MEM	**** * * *	19 : 47 : 45
[ABS]	[REL]	[ALL] [(OPRT)]

1.7.3 Alarm Display

When a trouble occurs during operation, error code and alarm message are displayed on the screen. (See Section III-7.1)

See APPENDIX G for the list of error codes and their meanings.

ALARM MESSAGE		O1000 N0003
010	IMPROPER G-CODE	
MEM STOP * * * * * ALM		19 : 55 : 22
[ALARM]	[MSG]	[HISTORY] [] []

1.7.4 Parts Count Display, Run Time Display

When this option is selected, two types of run time and number of parts are displayed on the screen. (See Section III-11.4.5)

ACTUAL POSITION (ABSOLUTE)		O0003 N00003	
X	150.000		
Y	300.000		
Z	100.000		
PART COUNT 18			
RUN TIME	0H16M	CYCLE TIME	0H 1M 0S
MEM STRT	****	FIN	20 : 22 : 23
{ ABS }	{ REL }	{ ALL }	{ (OPRT) }

1.7.5 Graphic Display

Programmed tool movement can be displayed on the following planes:
(See Section III-12)

- 1) XY plane
- 2) YZ plane
- 3) XZ plane
- 4) Three dimensional display

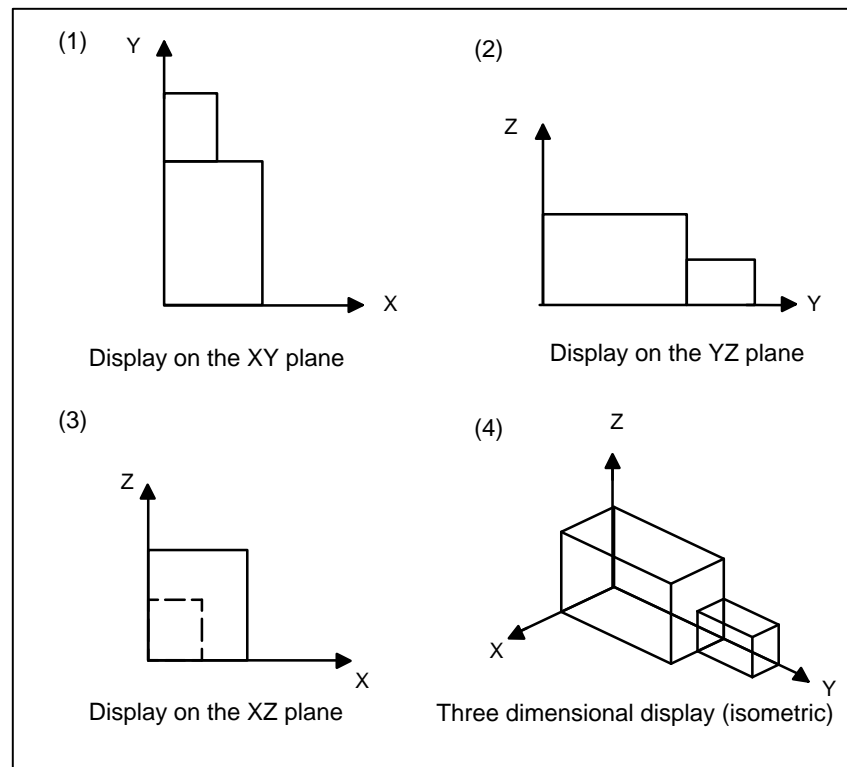


Fig. 1.7 (a) Graphic display

1.8 DATA INPUT / OUTPUT

Programs, offset values, parameters, etc. input in CNC memory can be output to paper tape, cassette, or a floppy disk for saving. After once output to a medium, the data can be input into CNC memory.

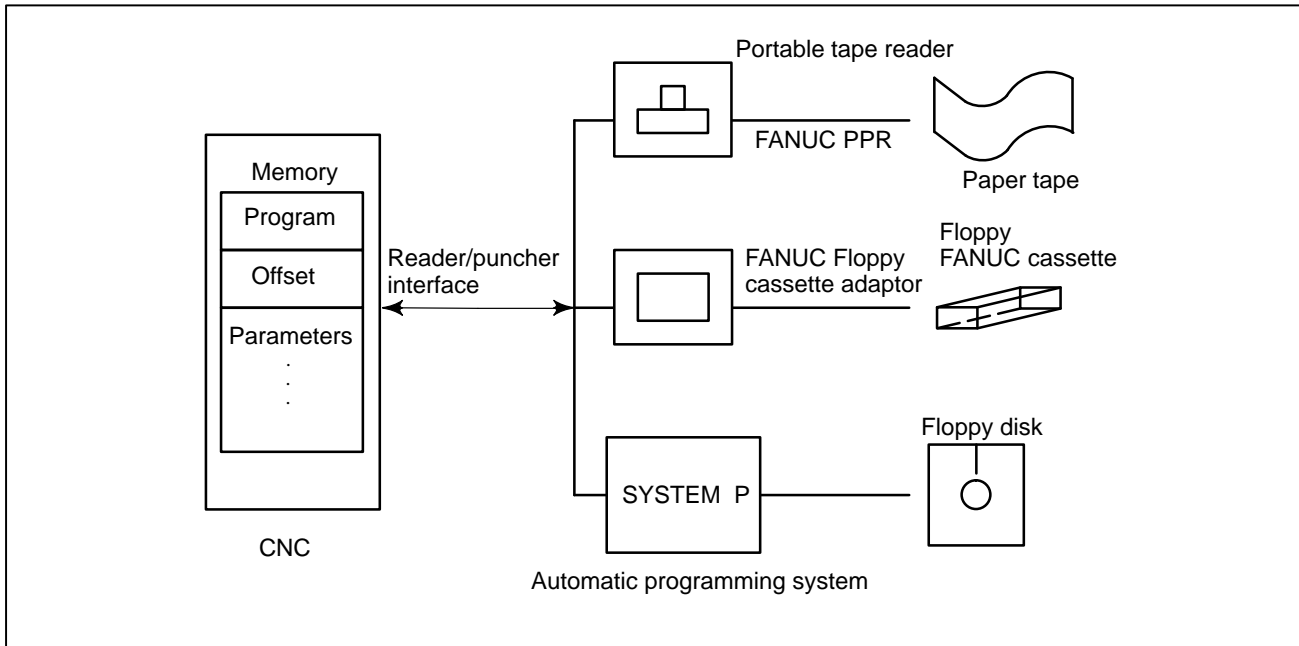


Fig.1.8 (a) Data Output

2

OPERATIONAL DEVICES



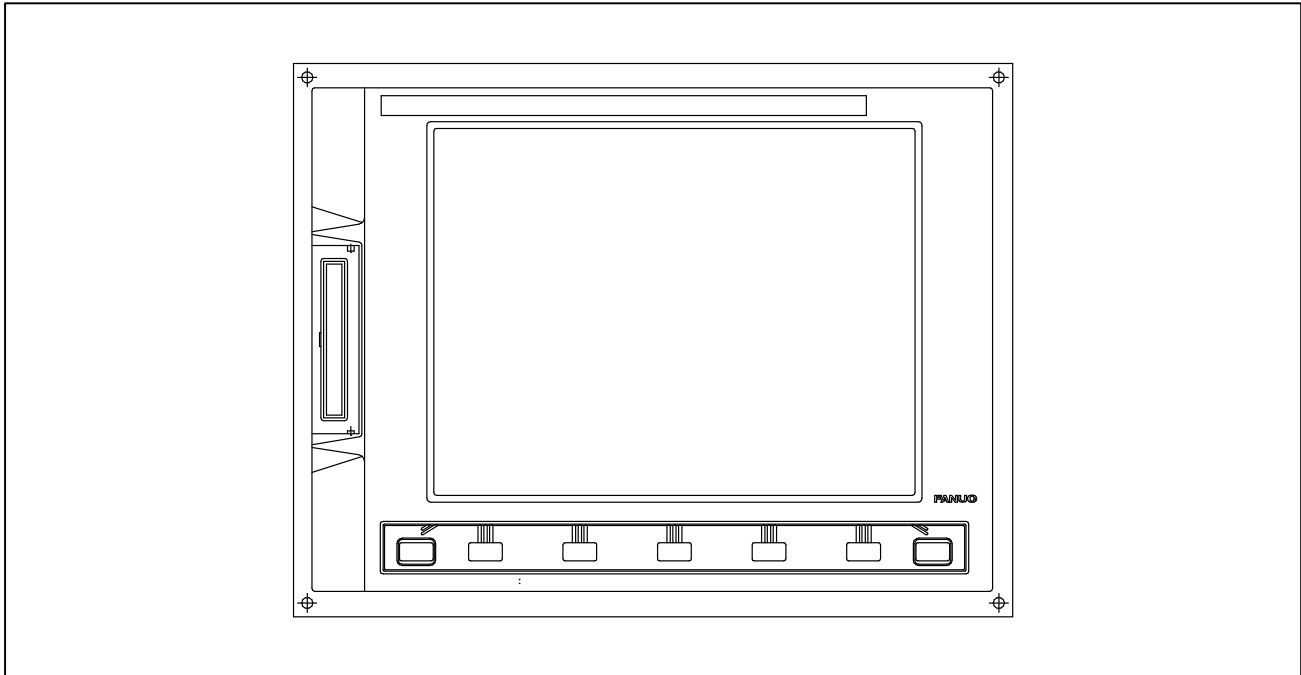
The available operational devices include the setting and display unit attached to the CNC, the machine operator's panel, and external input/output devices such as a tape reader, PPR, Handy File, Floppy Cassette, and FA Card.

2.1 SETTING AND DISPLAY UNITS

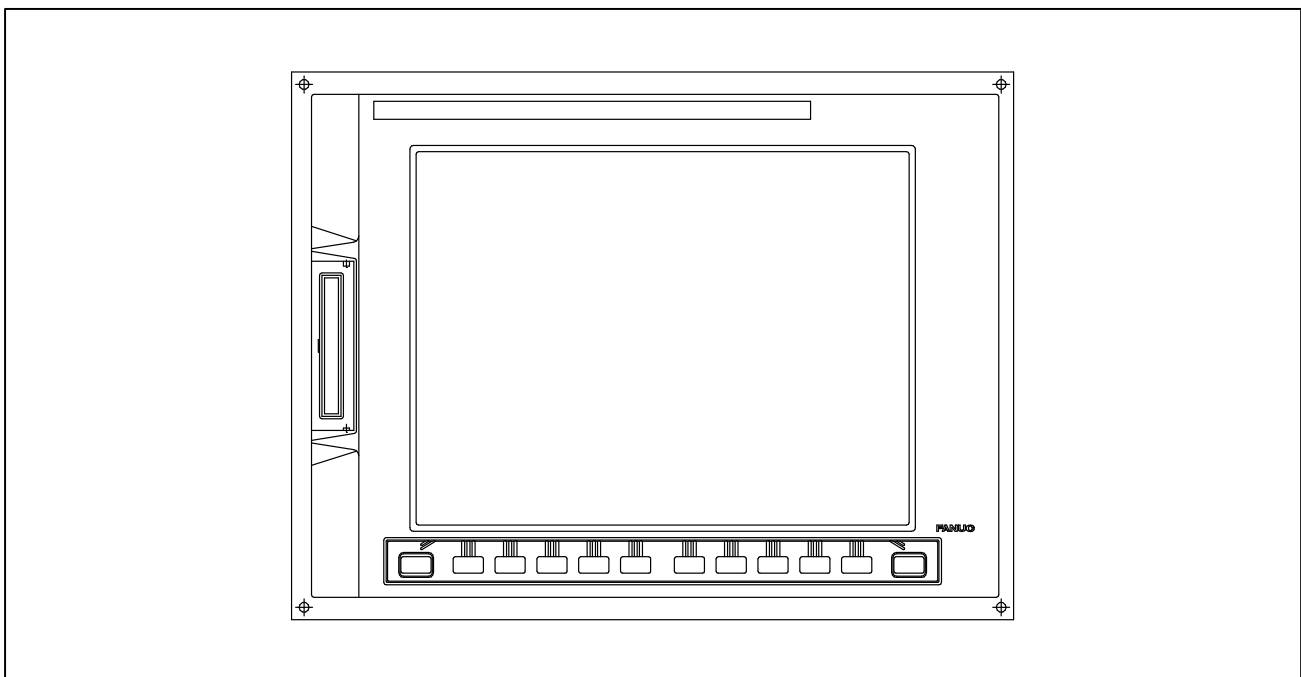
The setting and display units are shown in Subsections 2.1.1 to 2.1.6 of Part III.

CNC control unit with 7.2"/8.4" LCD	III-2.1.1
CNC control unit with 9.5"/10.4" LCD	III-2.1.2
Separate-type small MDI unit	III-2.1.3
Separate-type standard MDI unit (horizontal type)	III-2.1.4
Separate-type standard MDI unit (vertical type)	III-2.1.5
Separate-type standard MDI unit (vertical type) (for 160i/180i)	III-2.1.6

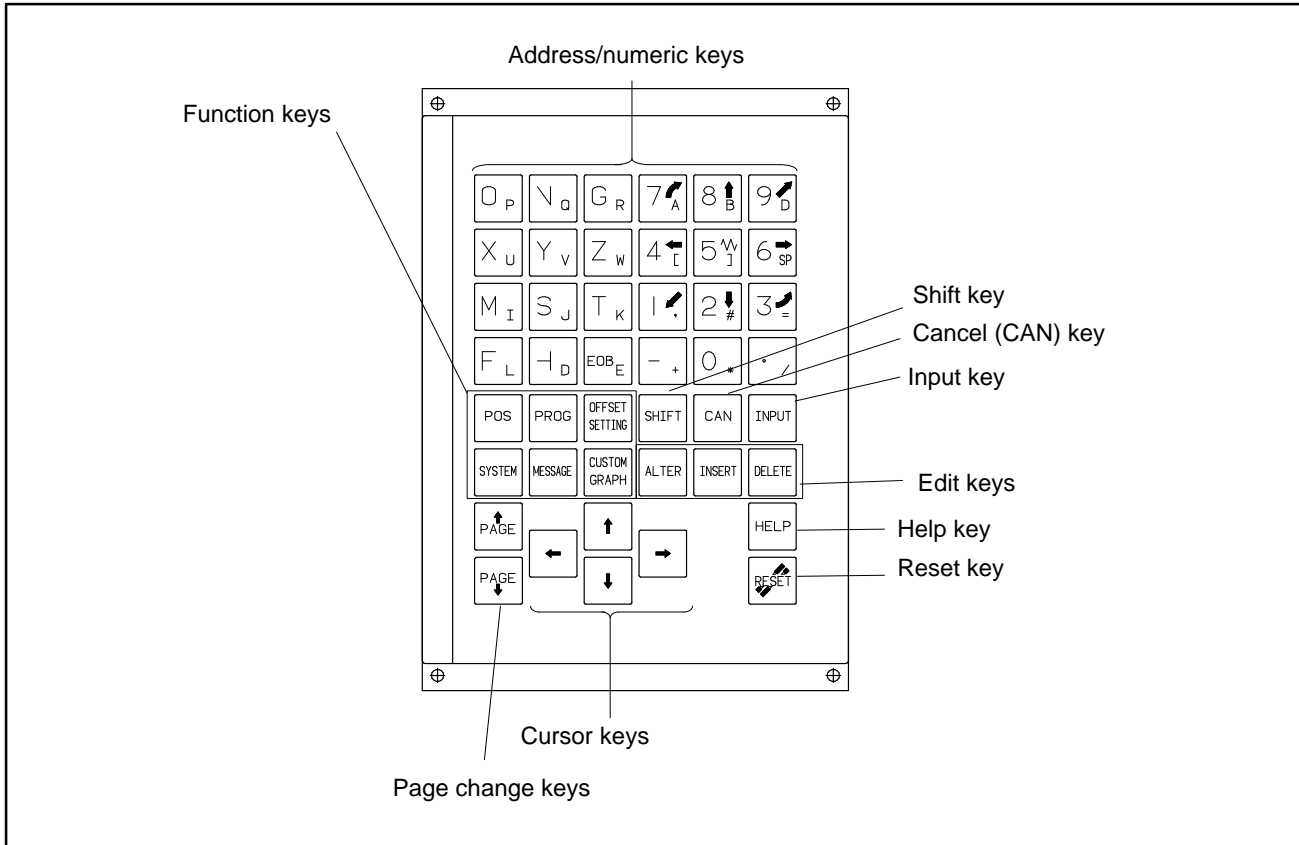
**2.1.1
CNC Control Unit with
7.2"/8.4" LCD**



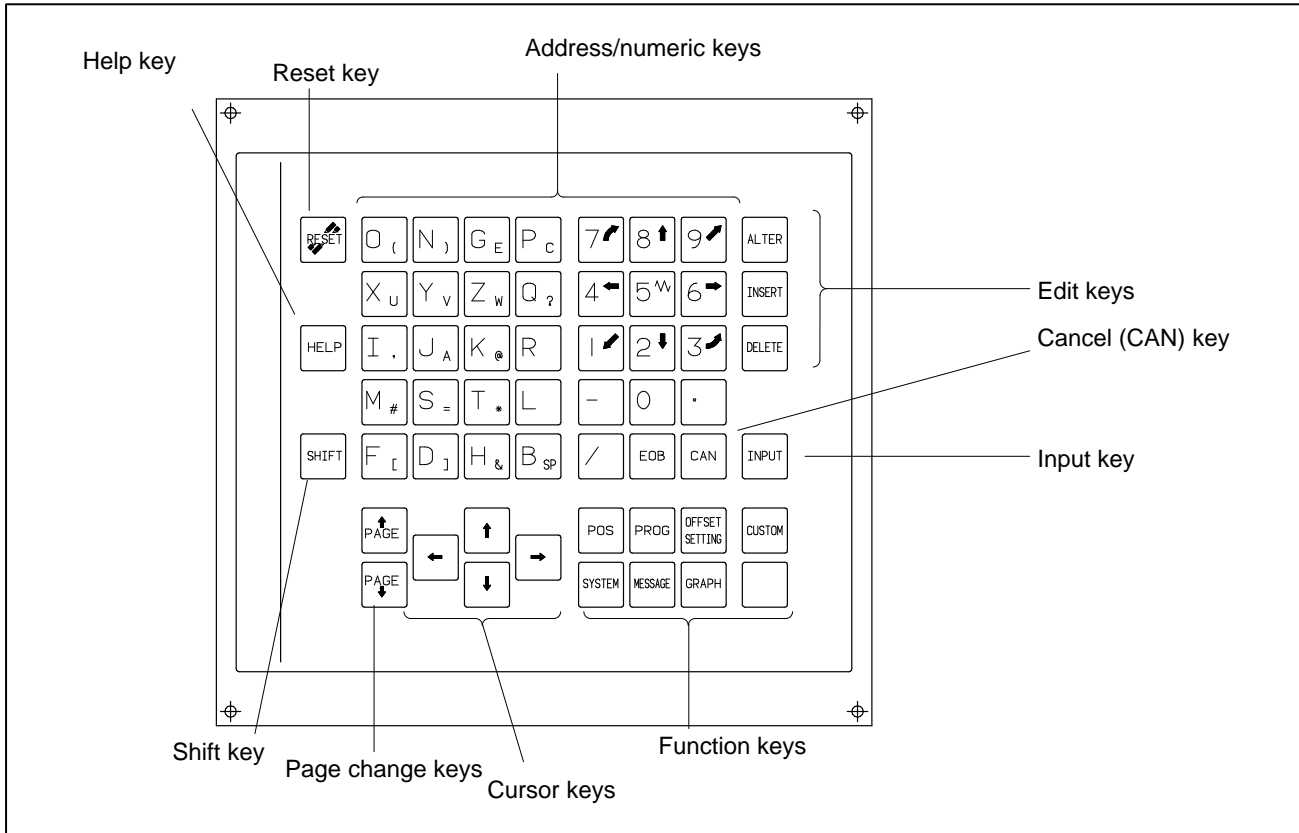
**2.1.2
CNC Control Unit with
9.5"/10.4" LCD**



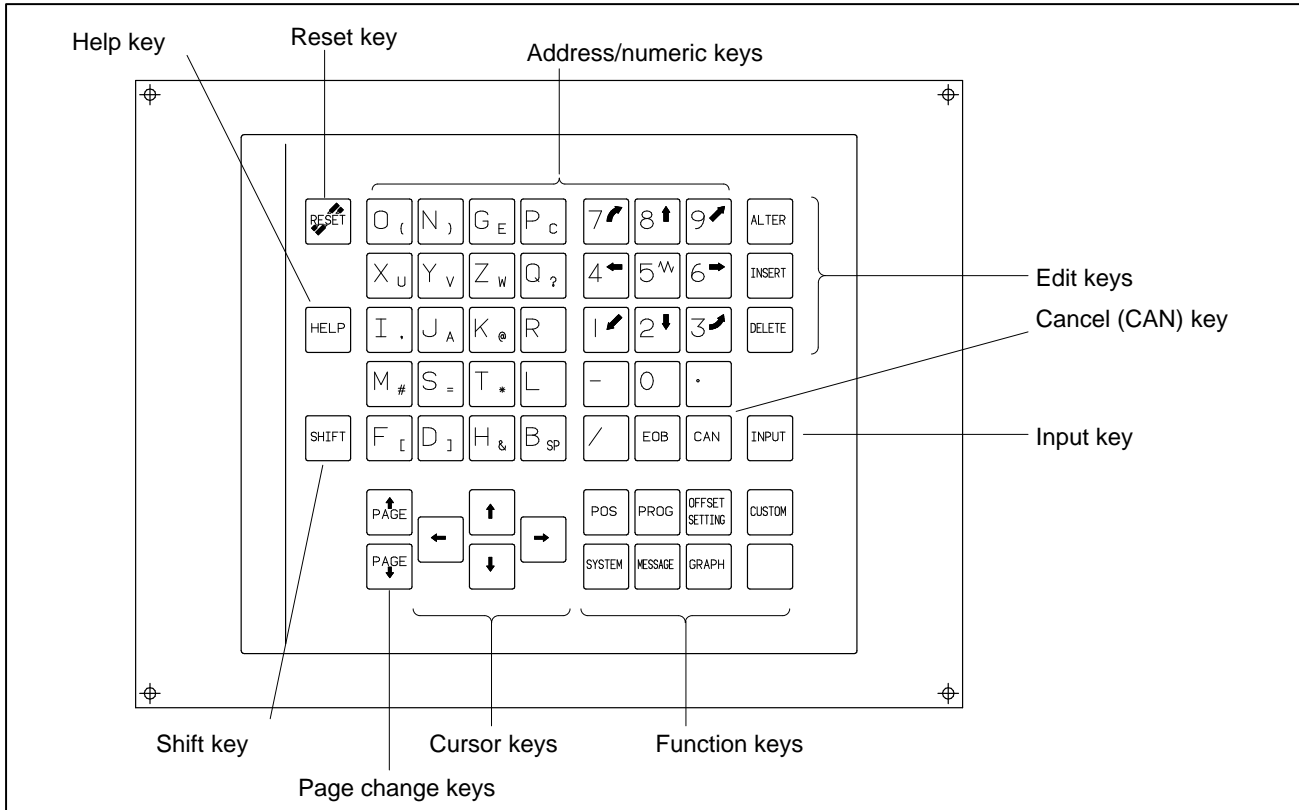
2.1.3 Separate-Type Small MDI Unit



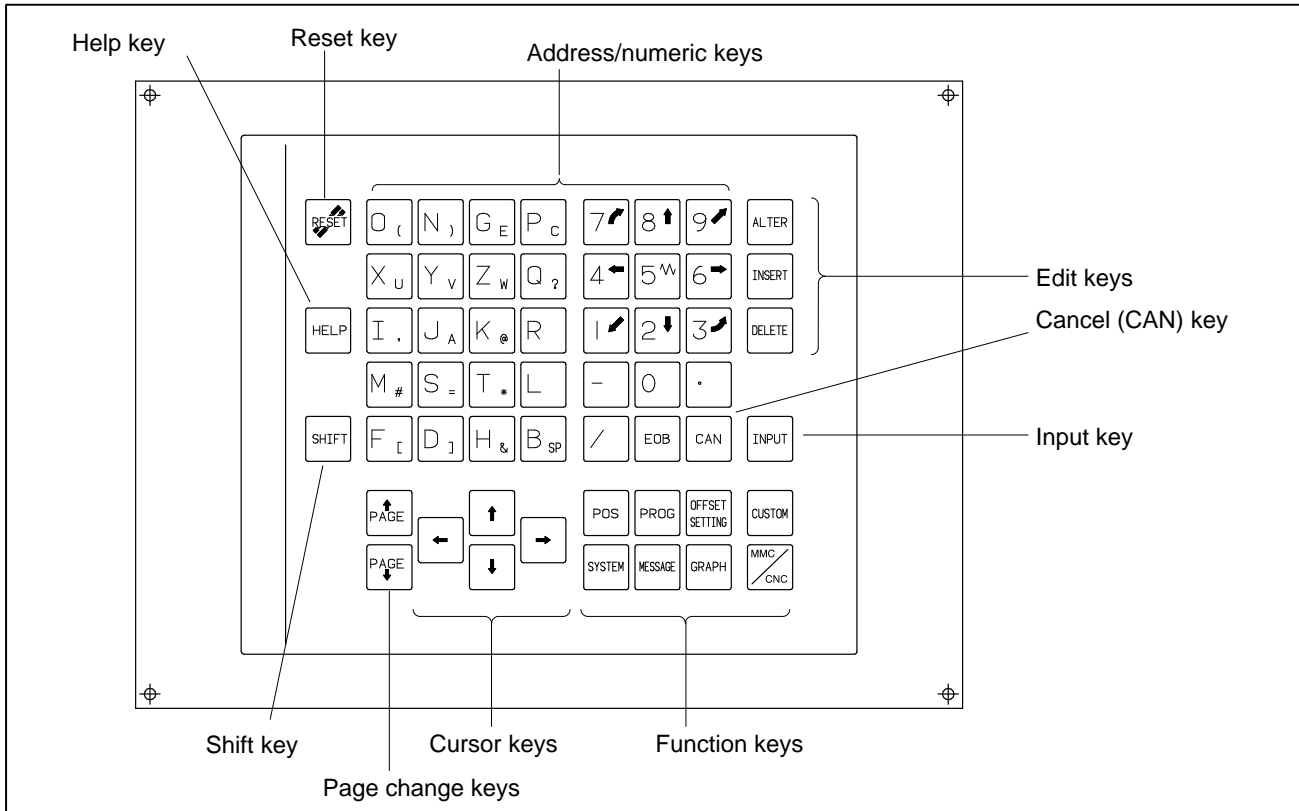
2.1.4 Separate-Type Standard MDI Unit (Horizontal Type)



2.1.5 Separate-Type Standard MDI Unit (Vertical Type)



2.1.6 Separate-Type Standard MDI Unit (Vertical Type) (for 160i/180i)



2.2 EXPLANATION OF THE KEYBOARD

Table2.2 Explanation of the MDI keyboard


















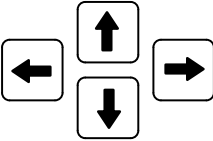








Number	Name	Explanation
1	RESET key 	Press this key to reset the CNC, to cancel an alarm, etc.
2	HELP key 	Press this button to use the help function when uncertain about the operation of an MDI key (help function).
3	Soft keys	The soft keys have various functions, according to the Applications. The soft key functions are displayed at the bottom of the screen.
4	Address and numeric keys   ...	Press these keys to input alphabetic, numeric, and other characters.
5	SHIFT key 	Some keys have two characters on their keytop. Pressing the <SHIFT> key switches the characters. Special character Ê is displayed on the screen when a character indicated at the bottom right corner on the keytop can be entered.
6	INPUT key 	When an address or a numerical key is pressed, the data is input to the buffer, and it is displayed on the screen. To copy the data in the key input buffer to the offset register, etc., press the  key. This key is equivalent to the [INPUT] key of the soft keys, and either can be pressed to produce the same result.
7	Cancel key 	Press this key to delete the last character or symbol input to the key input buffer. When the key input buffer displays >N001X100Z_ and the cancel  key is pressed, Z is canceled and >N001X100_ is displayed.
8	Program edit keys   	Press these keys when editing the program.  : Alteration  : Insertion  : Deletion
9	Function keys   ...	Press these keys to switch display screens for each function. See III – 2.3 for details of the function keys.

Table2.2 Explanation of the MDI keyboard

Number	Name	Explanation
10	Cursor move keys 	There are four different cursor move keys.  : This key is used to move the cursor to the right or in the forward direction. The cursor is moved in short units in the forward direction.  : This key is used to move the cursor to the left or in the reverse direction. The cursor is moved in short units in the reverse direction.  : This key is used to move the cursor in a downward or forward direction. The cursor is moved in large units in the forward direction.  : This key is used to move the cursor in an upward or reverse direction. The cursor is moved in large units in the reverse direction.
11	Page change keys  	Two kinds of page change keys are described below.  : This key is used to changeover the page on the screen in the forward direction.  : This key is used to changeover the page on the screen in the reverse direction.

Explanations

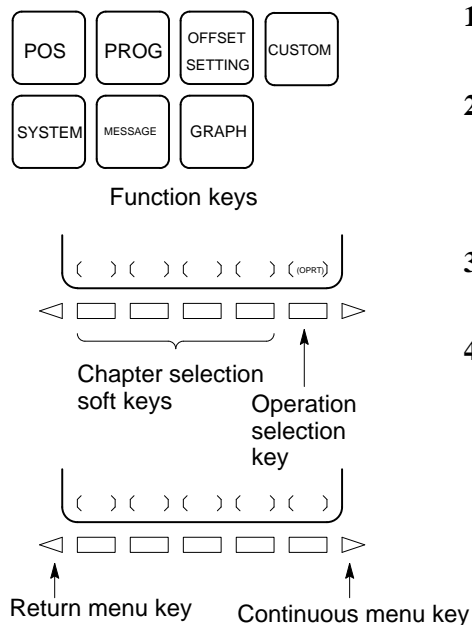
- **2-path lathe control**

In the 2-path lathe control, be sure to select the tool post for which data is specified, using the tool-post selection switch on the machine operator's panel. Then, perform keyboard operation, such as displaying or specifying various data items, and editing a program.

2.3 FUNCTION KEYS AND SOFT KEYS

The function keys are used to select the type of screen (function) to be displayed. When a soft key (section select soft key) is pressed immediately after a function key, the screen (section) corresponding to the selected function can be selected.

2.3.1 General Screen Operations



- 1 Press a function key on the MDI panel. The chapter selection soft keys that belong to the selected function appear.
- 2 Press one of the chapter selection soft keys. The screen for the selected chapter appears. If the soft key for a target chapter is not displayed, press the continuous menu key (next–menu key). In some cases, additional chapters can be selected within a chapter.
- 3 When the target chapter screen is displayed, press the operation selection key to display data to be manipulated.
- 4 To redisplay the chapter selection soft keys, press the return menu key.

The general screen display procedure is explained above. However, the actual display procedure varies from one screen to another. For details, see the description of individual operations.

2.3.2 Function Keys

Function keys are provided to select the type of screen to be displayed. The following function keys are provided on the MDI panel:



Press this key to display the **position screen**.



Press this key to display the **program screen**.



Press this key to display the **offset/setting screen**.



Press this key to display the **system screen**.



Press this key to display the **message screen**.



Press this key to display the **graphics screen**.









Press this key to display the **custom screen (conversational macro screen)**.

2.3.3 Soft Keys

To display a more detailed screen, press a function key followed by a soft key. Soft keys are also used for actual operations.

The following illustrates how soft key displays are changed by pressing each function key.

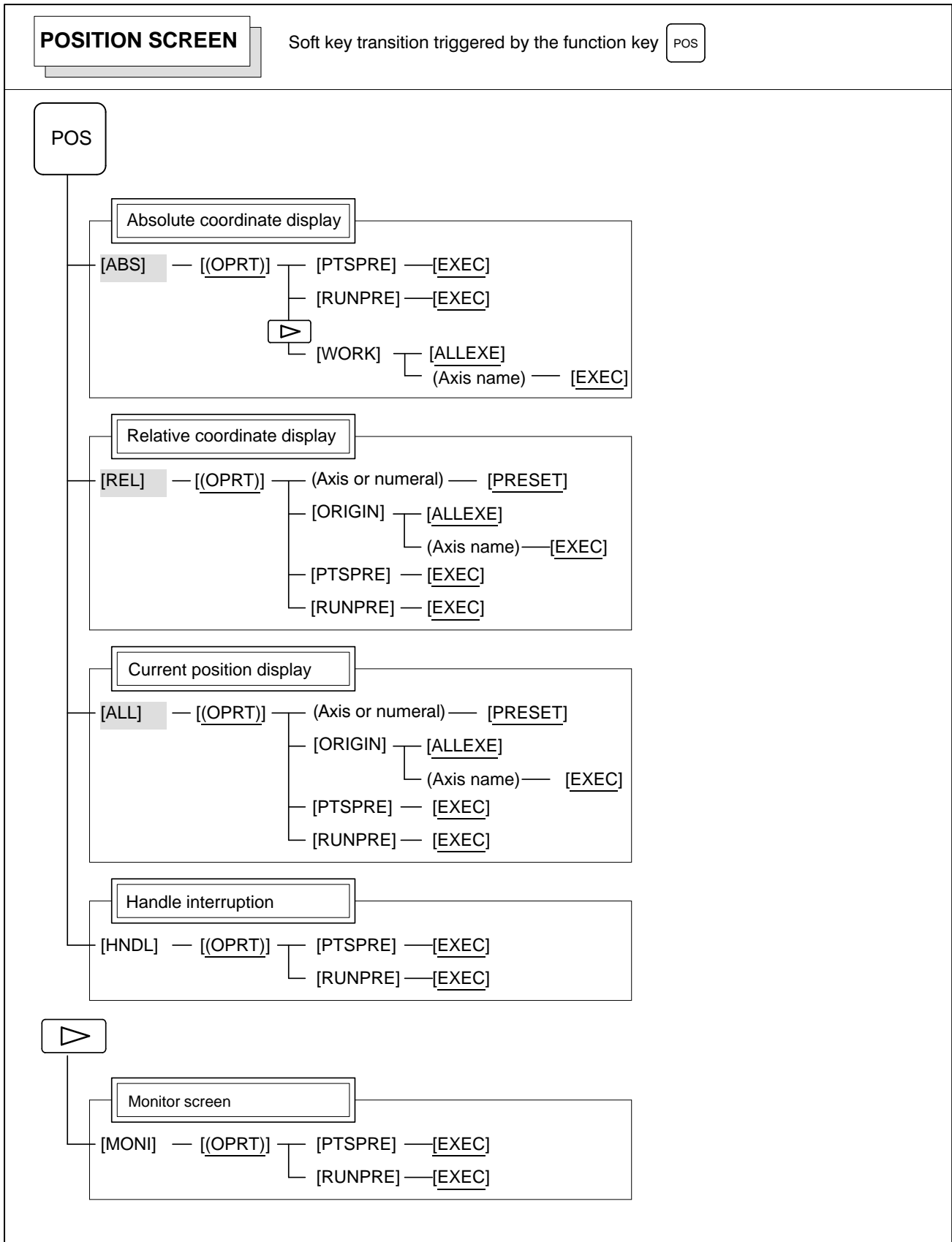
The symbols in the following figures mean as shown below :

	: Indicates screens
	: Indicates a screen that can be displayed by pressing a function key(*1)
	: Indicates a soft key(*2)
	: Indicates input from the MDI panel.
	: Indicates a soft key displayed in green.
	: Indicates the continuous menu key (rightmost soft key)(*3).

*1 Press function keys to switch between screens that are used frequently.

*2 Some soft keys are not displayed depending on the option configuration.

*3 In some cases, the continuous menu key is omitted when the 12 soft keys display unit is used.



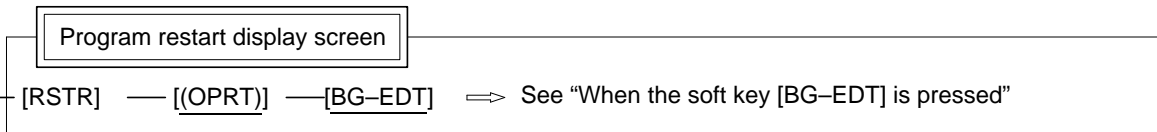
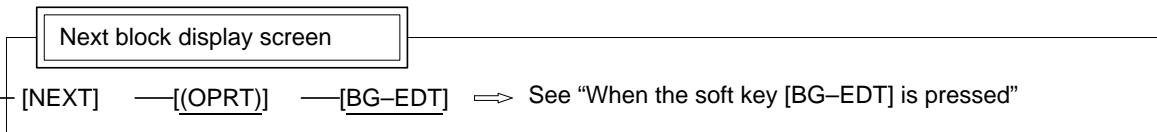
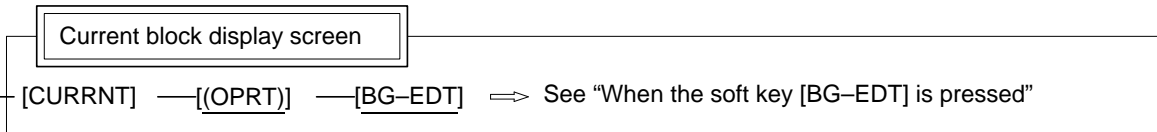
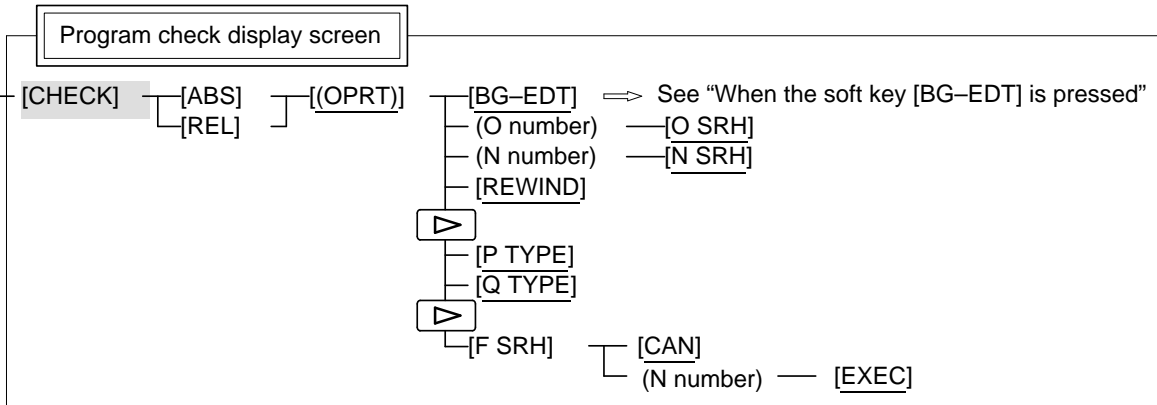
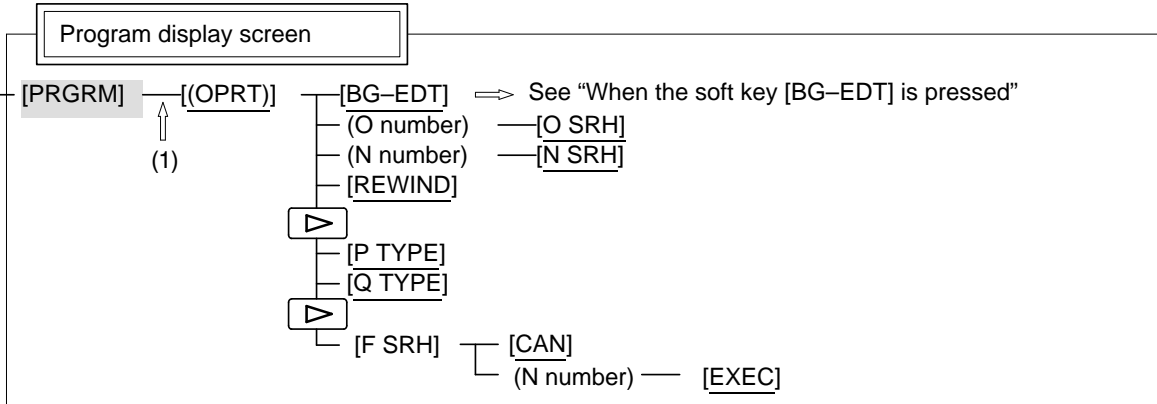
PROGRAM SCREEN

Soft key transition triggered by the function key in the MEM mode

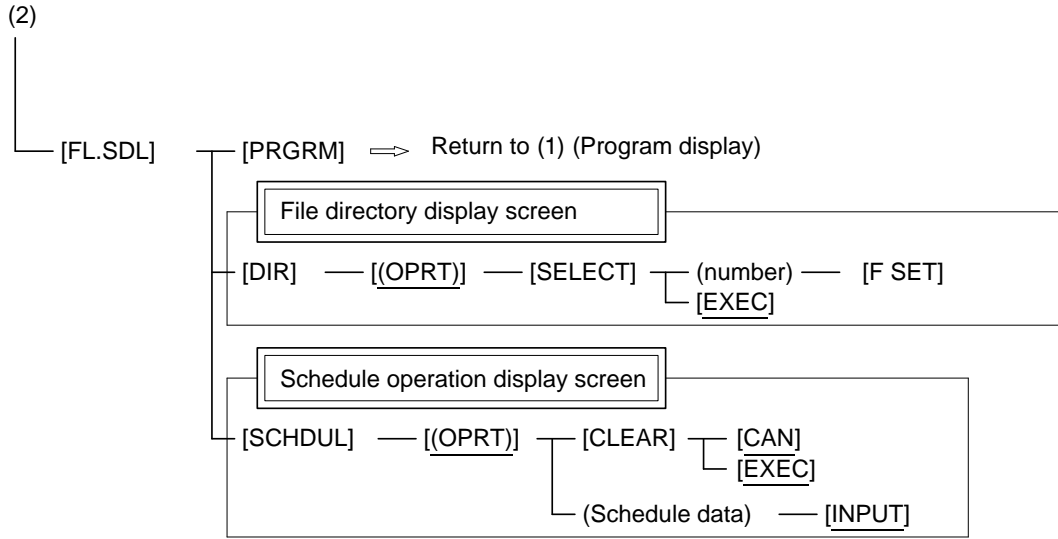
PROG

1/2

PROG



(2)(Continued on the next page)



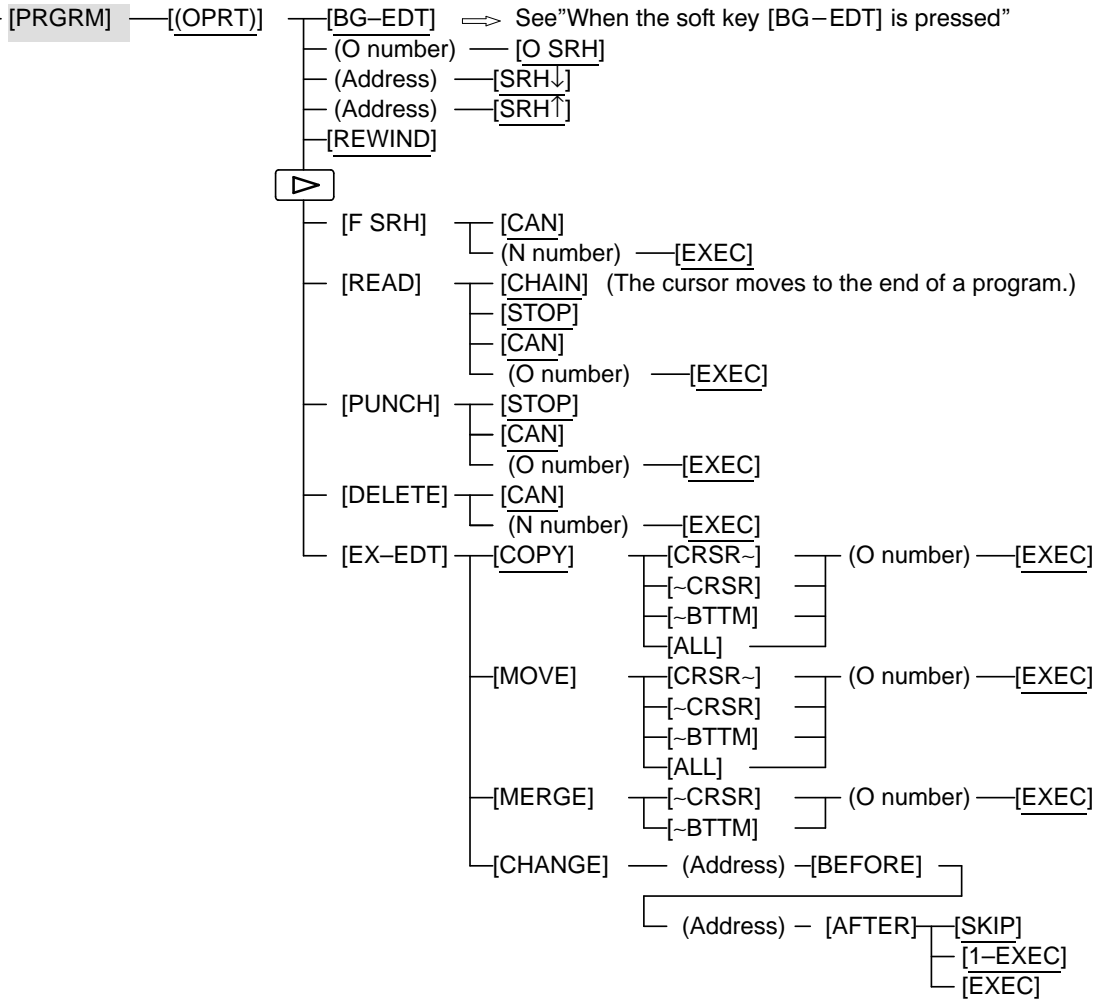
PROGRAM SCREEN

Soft key transition triggered by the function key PROG in the EDIT mode

1/2

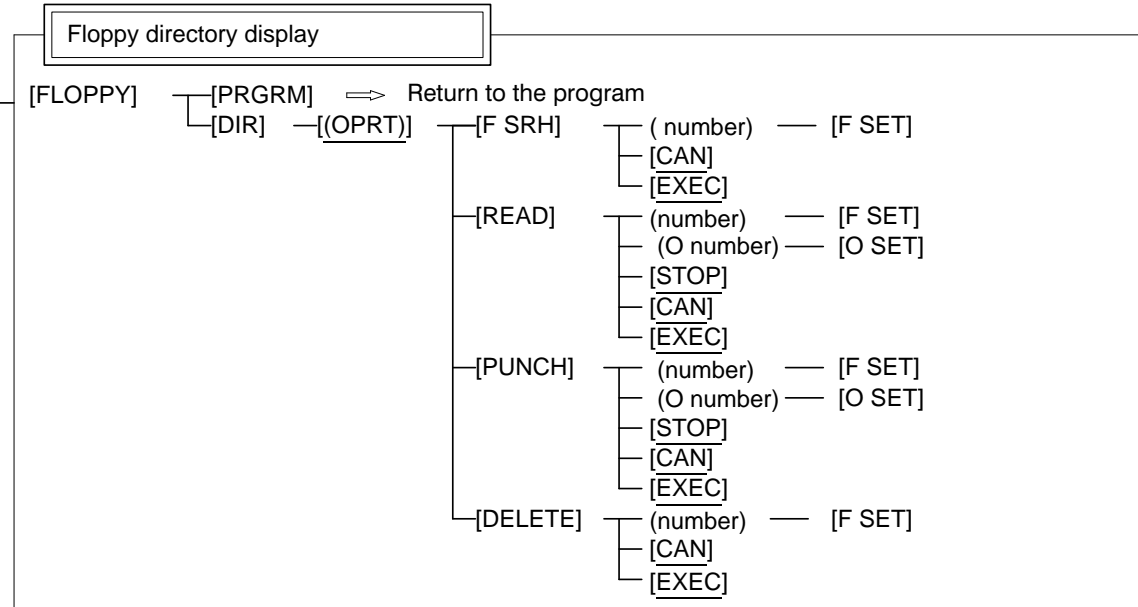
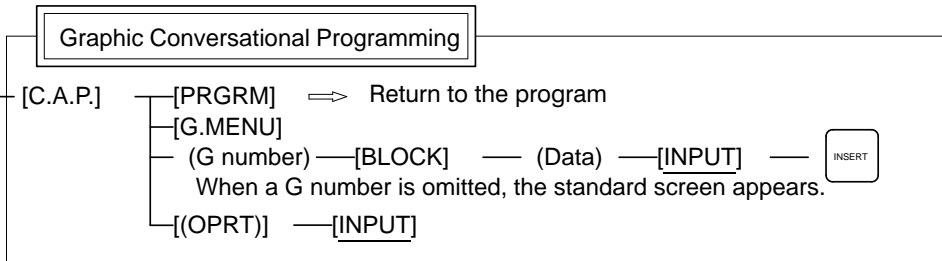
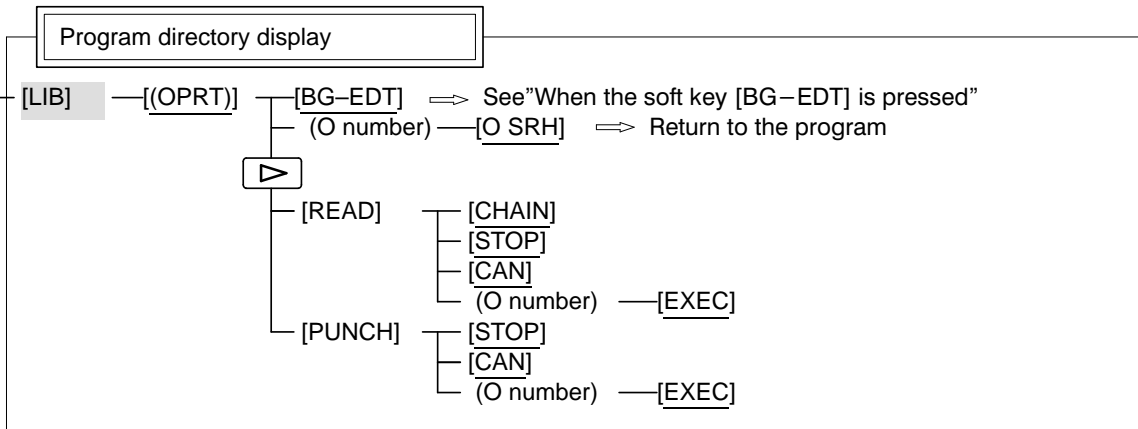
PROG

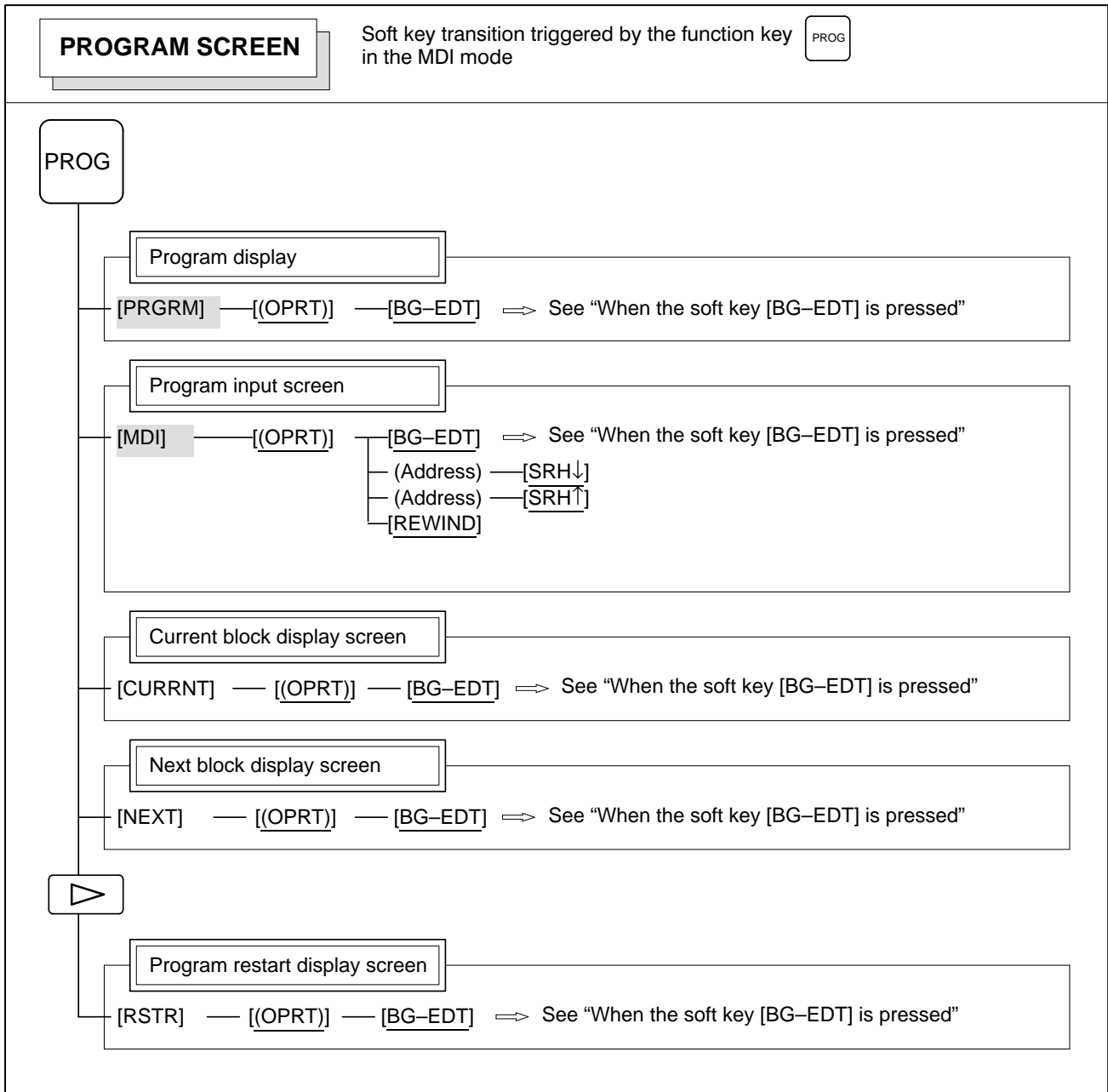
Program display

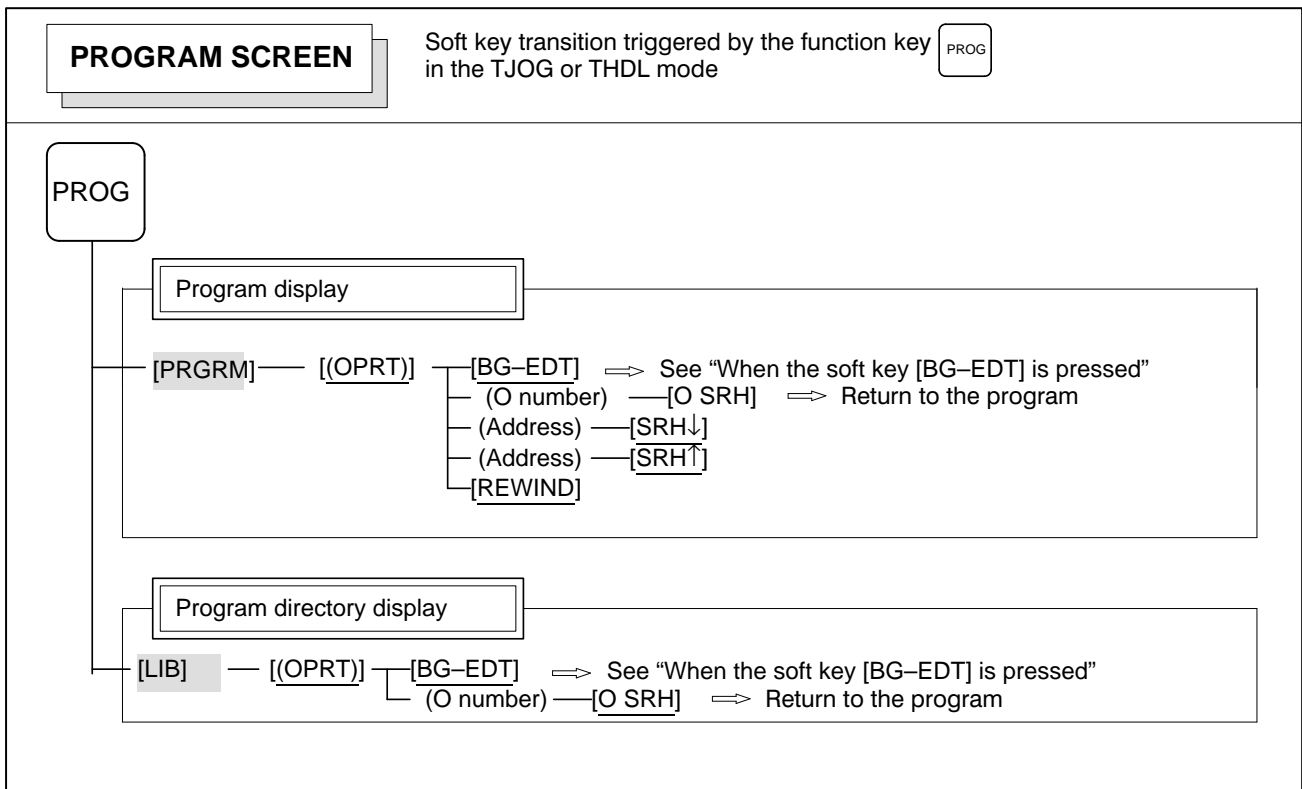
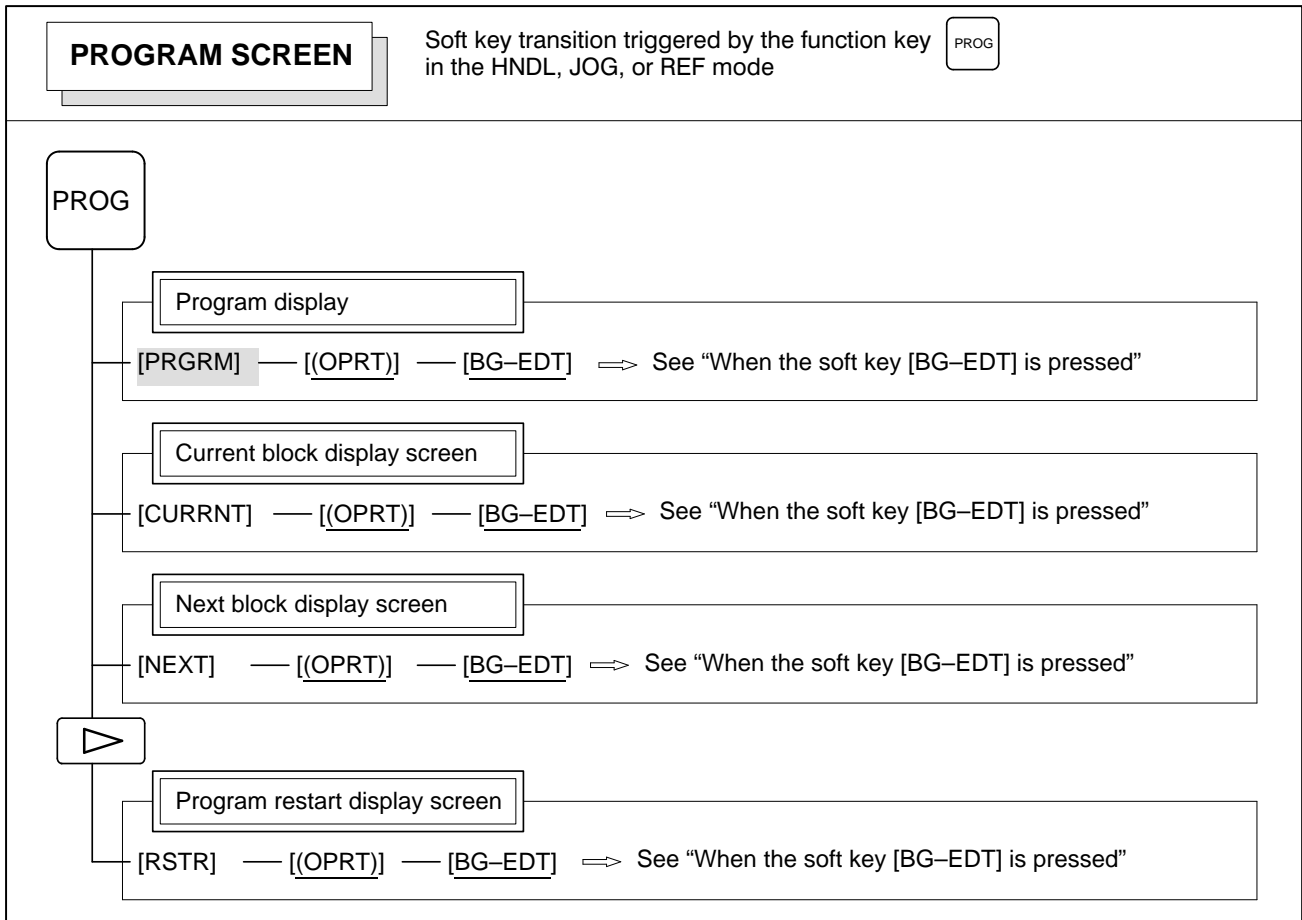


(1)(Continued on the next page)

(1)







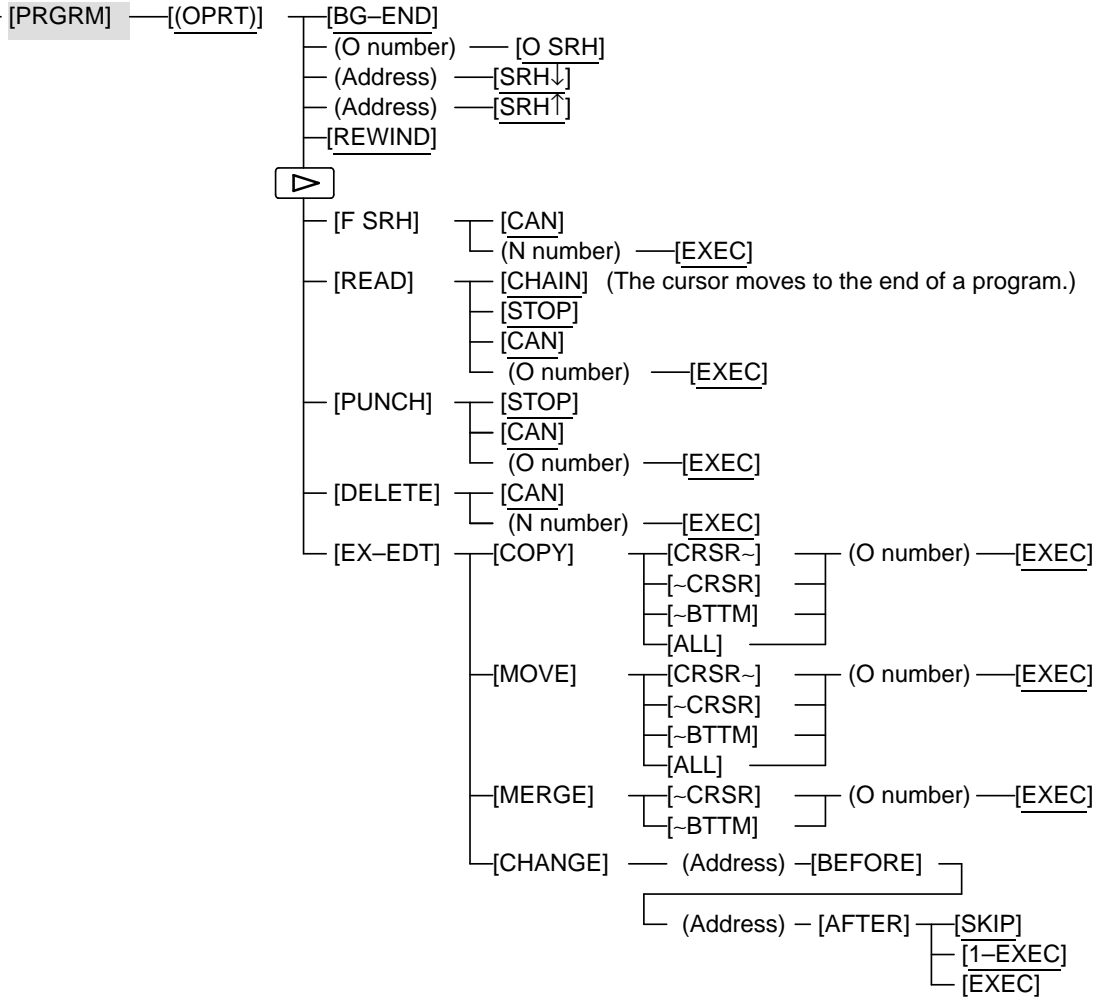
PROGRAM SCREEN

Soft key transition triggered by the function key PROG
 (When the soft key [BG-EDT] is pressed in all modes)

1/2

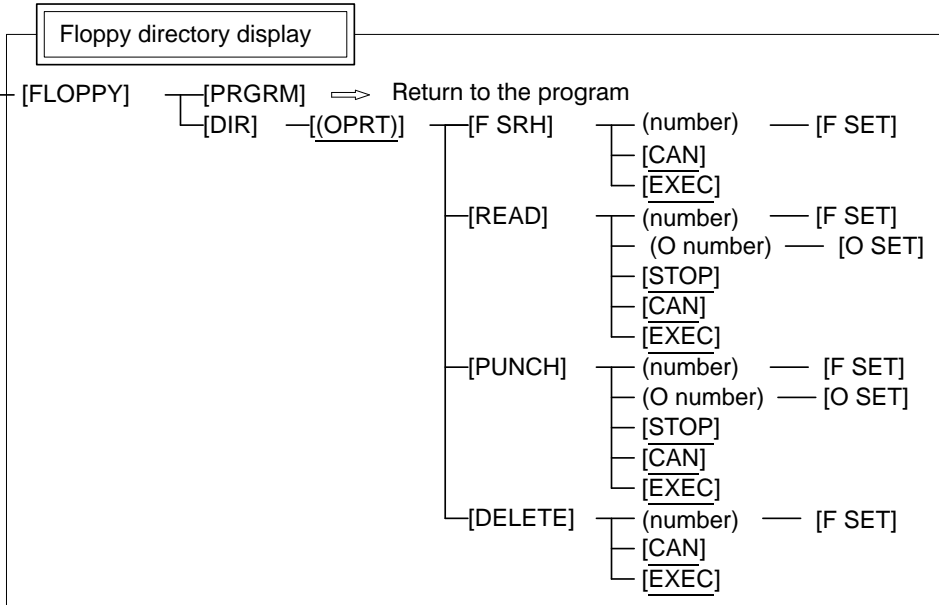
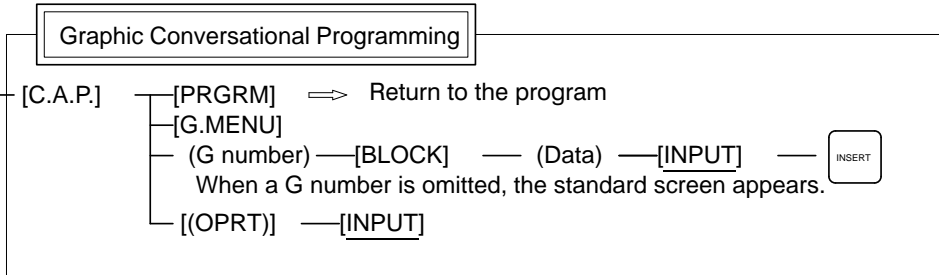
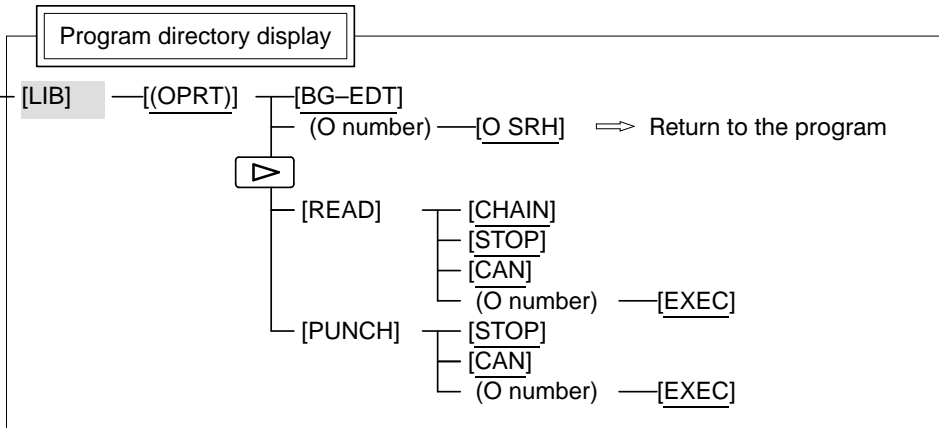
PROG

Program display




(1)(Continued on the next page)

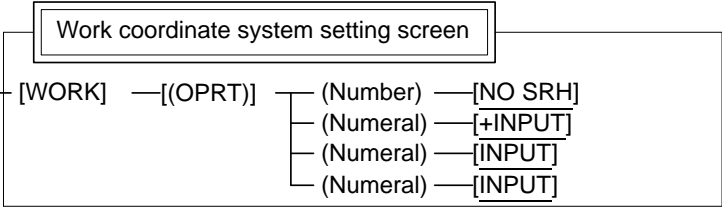
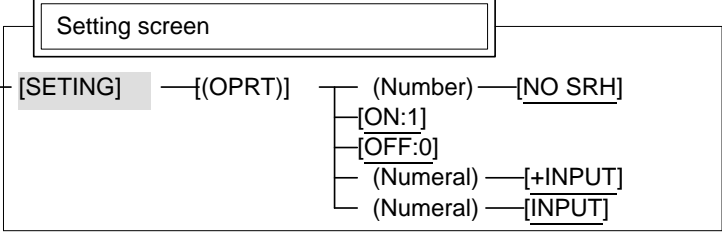
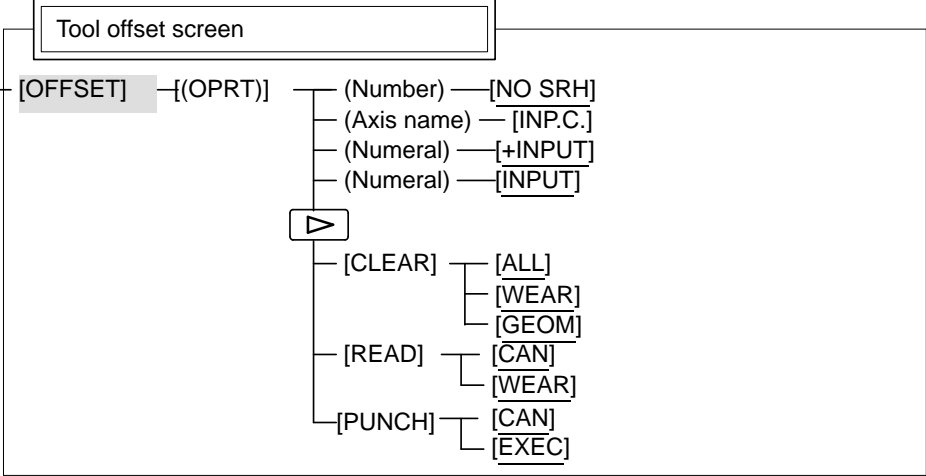
(1)



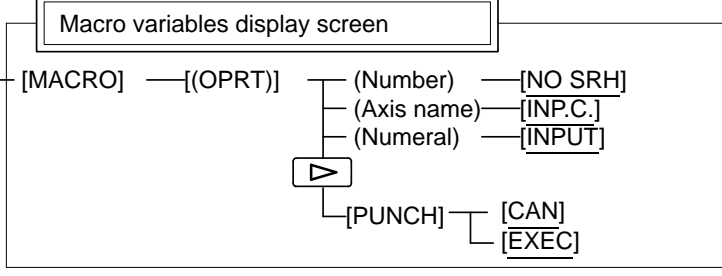
OFFSET/SETTING SCREEN

Soft key transition triggered by the function key 

OFFSET
SETTING

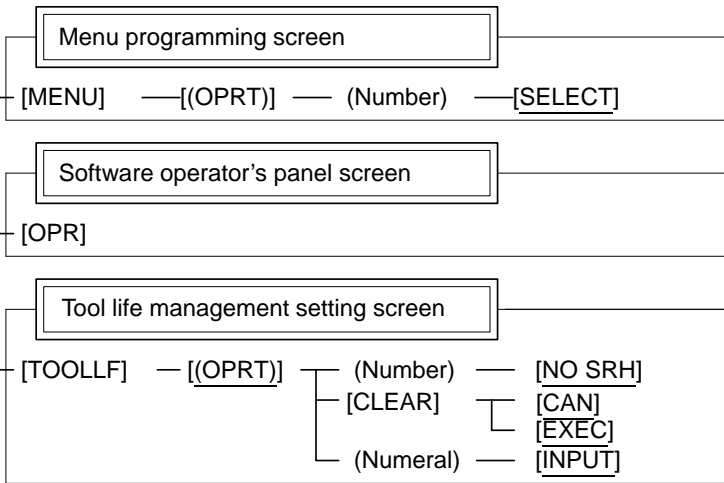


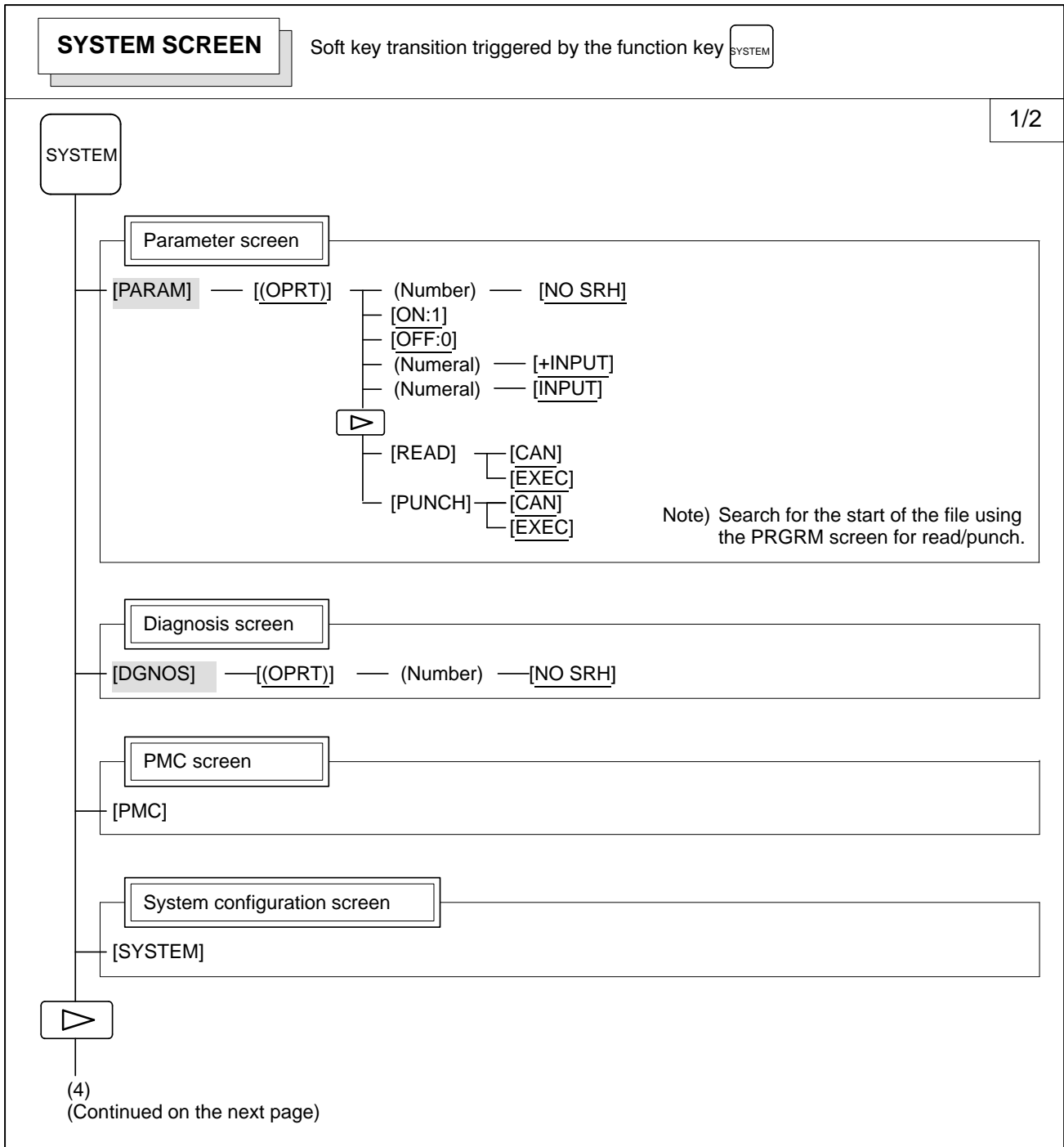
[▶]



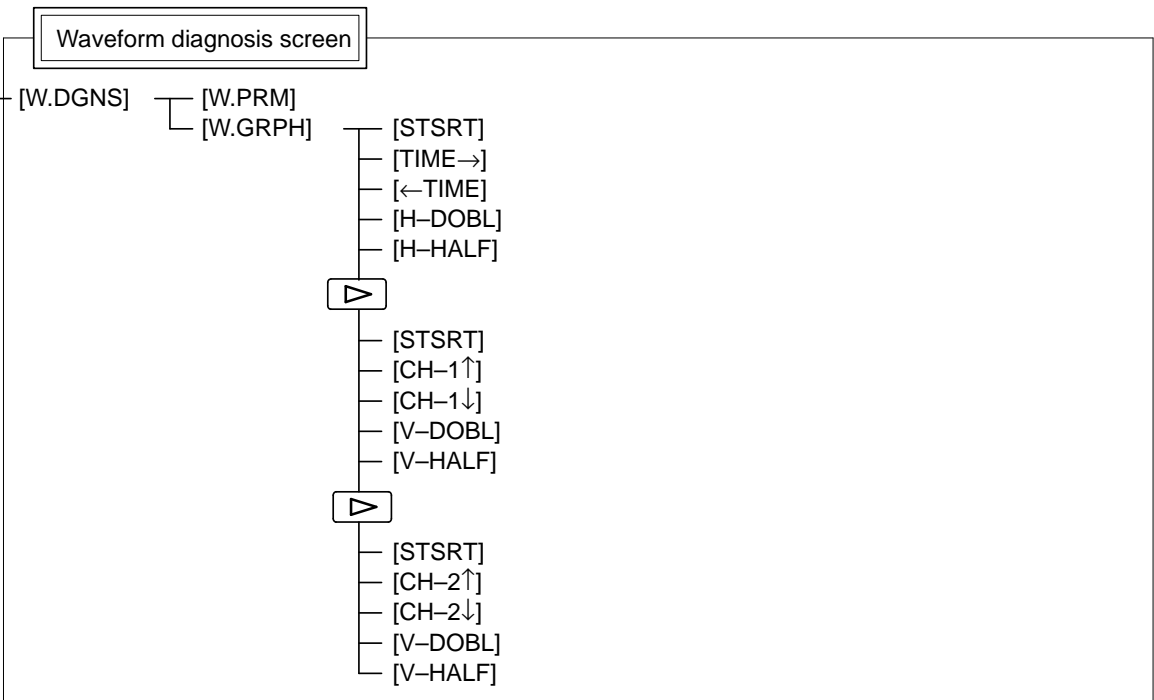
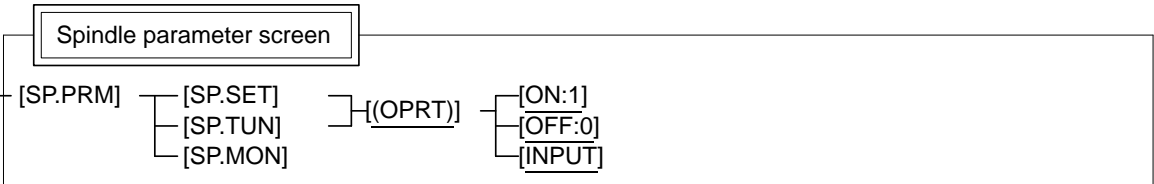
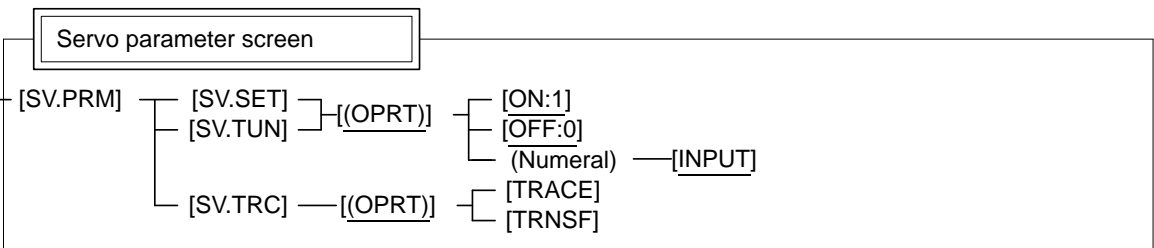
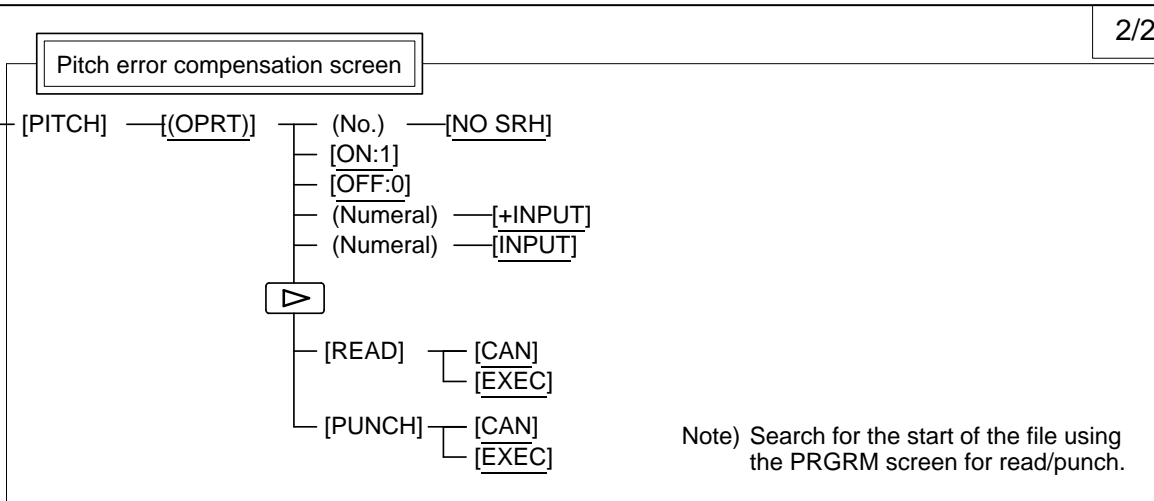
(1)

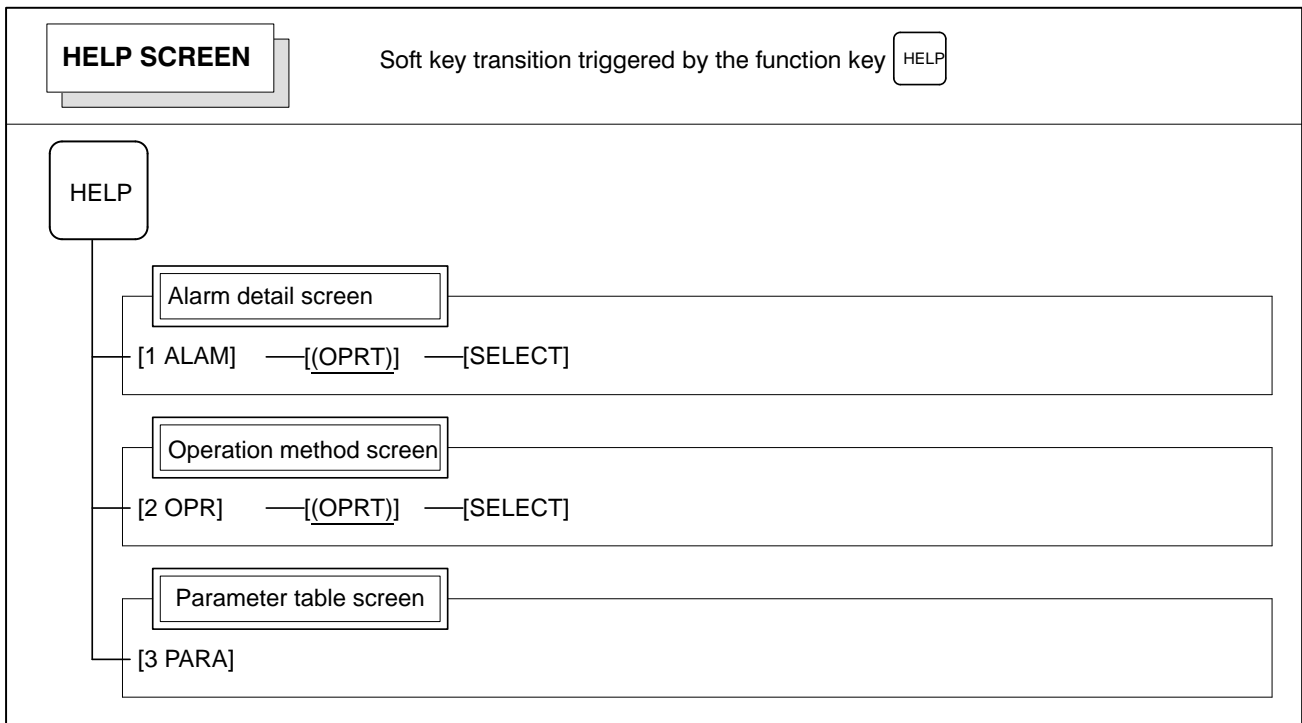
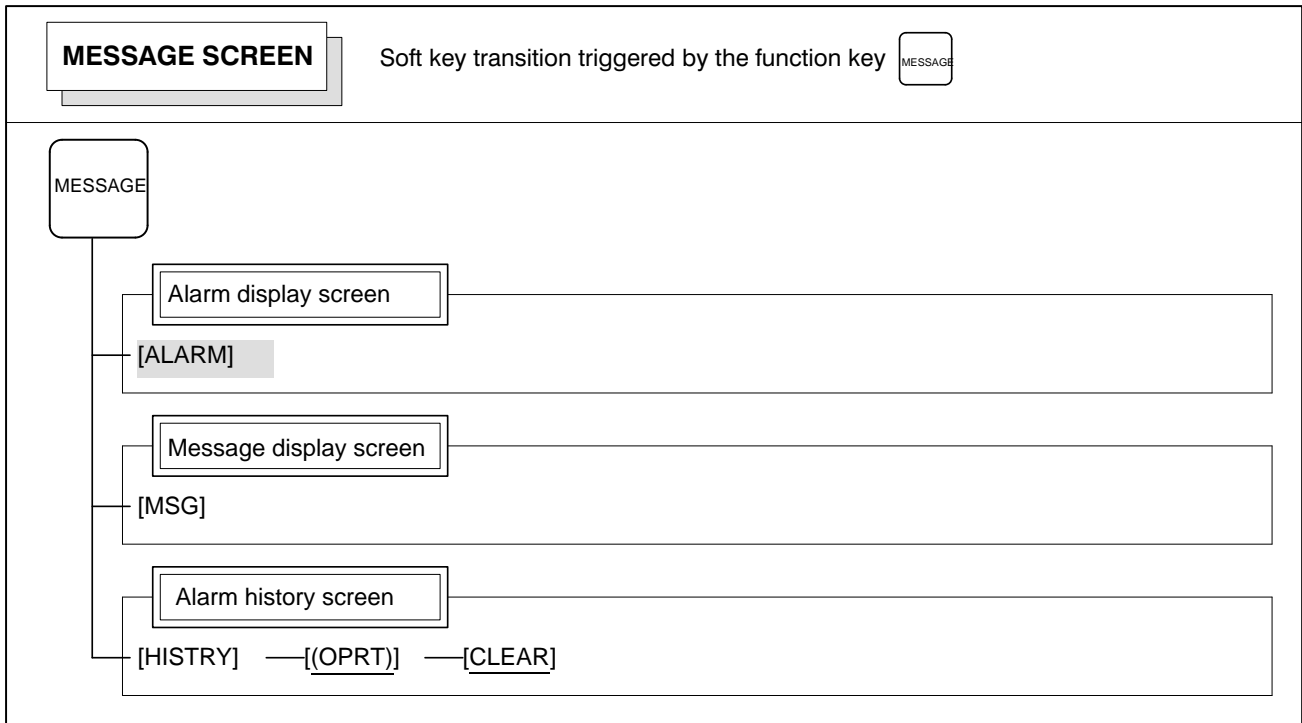
(1)

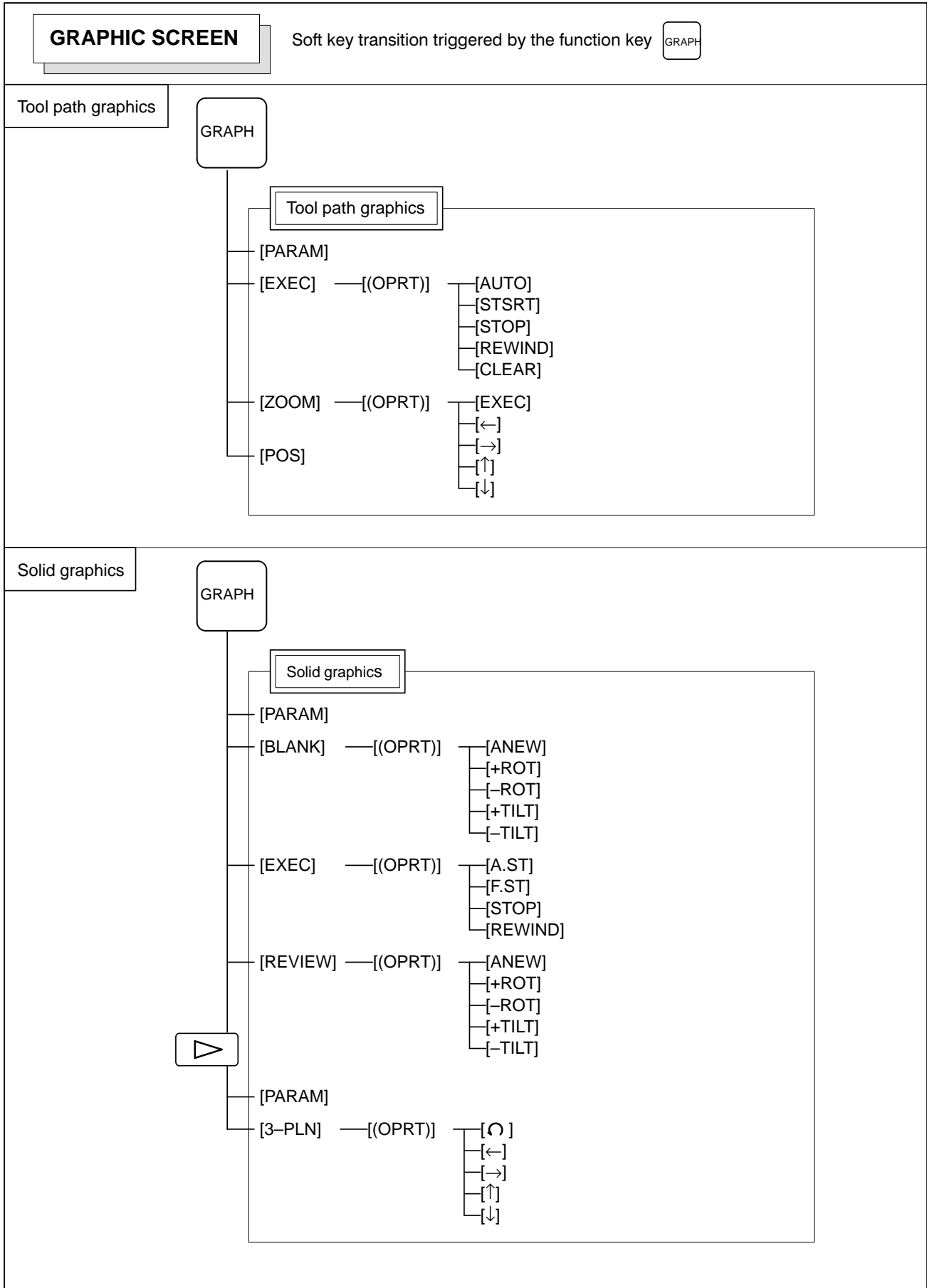




(4)







2.3.4 Key Input and Input Buffer

When an address and a numerical key are pressed, the character corresponding to that key is input once into the key input buffer. The contents of the key input buffer is displayed at the bottom of the CRT screen.

In order to indicate that it is key input data, a “>” symbol is displayed immediately in front of it. A “_” is displayed at the end of the key input data indicating the input position of the next character.

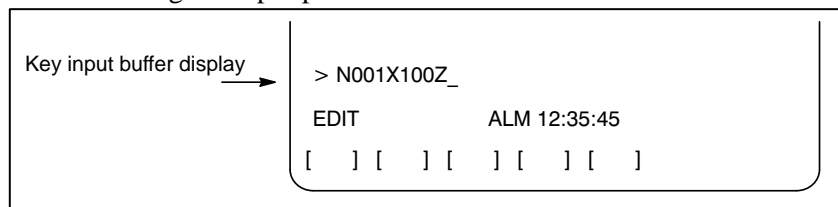






Fig. 2.3.4 Key input buffer display

To input the lower character of the keys that have two characters inscribed on them, first press the  key and then the key in question.

When the  key is pressed, “_” indicating the next character input position changes to “~”. Now lowercase characters can be entered (shift state).


When a character is input in shift status the shift status is canceled. Furthermore, if the  key is pressed in shift status, the shift status is canceled.

It is possible to input up to 32 characters at a time in the key input buffer. Press the  key to cancel a character or symbol input in the key input buffer.

(Example)

When the key input buffer displays

>N001X100Z_

and the cancel  key is pressed, Z is canceled and

>N001X100_

is displayed.

2.3.5 Warning Messages

After a character or number has been input from the MDI panel, a data check is executed when key or a soft key is pressed. In the case of incorrect input data or the wrong operation a flashing warning message will be displayed on the status display line.

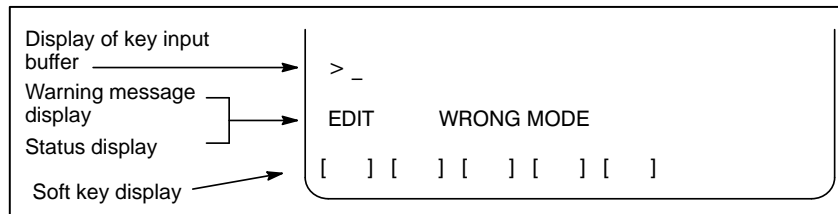


Fig. 2.3.5 Warning message display

Table2.3.5 Warning Messages

Warning message	Content
FORMAT ERROR	The format is incorrect.
WRITE PROTECT	Key input is invalid because of data protect key or the parameter is not write enabled.
DATA IS OUT OF RANGE	The input value exceeds the permitted range.
TOO MANY DIGITS	The input value exceeds the permitted number of digits.
WRONG MODE	Parameter input is not possible in any mode other than MDI mode.
EDIT REJECTED	It is not possible to edit in the current CNC status.

2.3.6 Soft Key Configuration

There are 12 soft keys in the 10.4"LCD/MDI or 9.5"LCD/MDI. As illustrated below, the 5 soft keys on the right and those on the right and left edges operate in the same way as the 7.2"LCD or 8.4" LCD, whereas the 5 keys on the left hand side are expansion keys dedicated to the 10.4"LCD or 9.5"LCD.

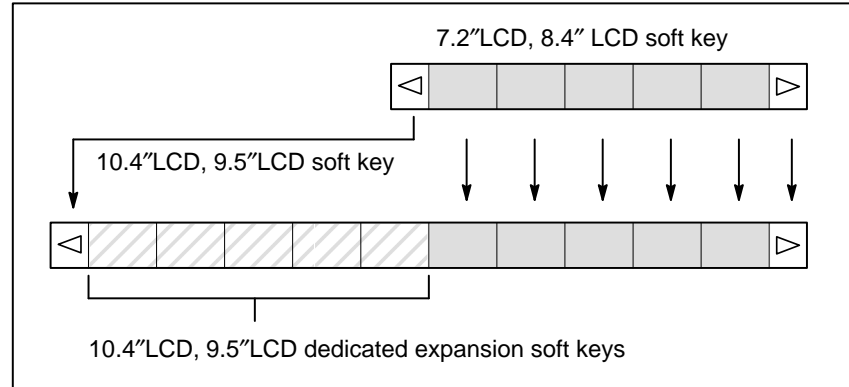
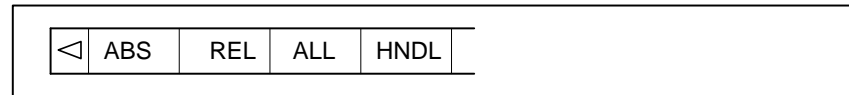


Fig. 2.3.6(a) LCD soft key configuration

Whenever a position display appears in the left half of the screen after a function key other than **POS** is pressed, the soft keys on the left half of the soft key display area are displayed as follows:



The soft key corresponding to the position display is indicated in reverse video.

This manual may refer to 10.4" and 9.5"LCD display units as 12 soft key types, and 7.2" and 8.4" LCD display units as 7 soft key types.

2.4 EXTERNAL I/O DEVICES

Five types of external input/output devices are available. This section outlines each device. For details on these devices, refer to the corresponding manuals listed below.

Table 2.4 (a) External I/O device

Device name	Usage	Max. storage capacity	Reference manual
FANUC Handy File	Easy-to-use, multi function input/output device. It is designed for FA equipment and uses floppy disks.	3600m	B-61834E
FANUC Floppy Cassette	Input/output device. Uses floppy disks.	2500m	B-66040E
FANUC FA Card	Compact input/output device. Uses FA cards.	160m	B-61274E
FANUC PPR	Input/output device consisting of a paper tape reader, tape punch, and printer.	275m	B-58584E
Portable Tape Reader	Input device for reading paper tape.	_____	Appendix H

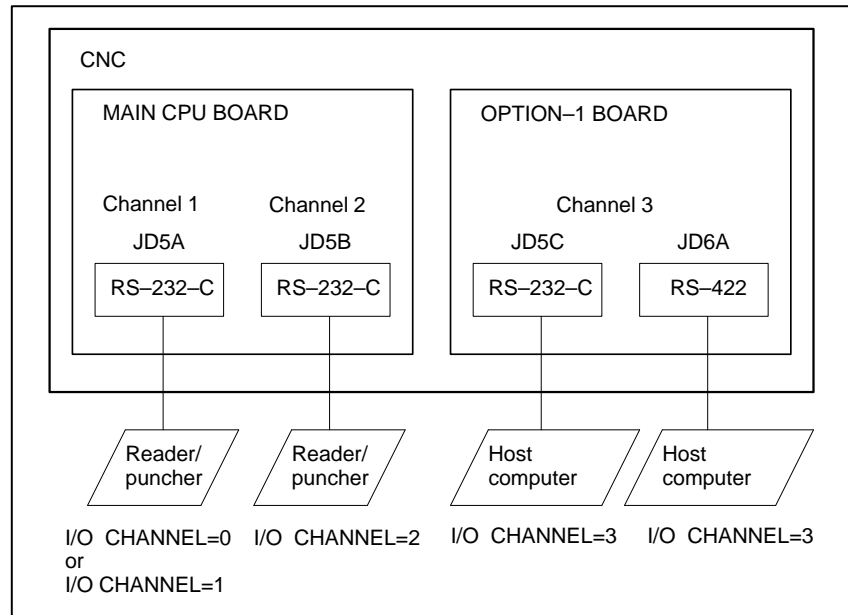
The following data can be input/output to or from external input/output devices:

- 1. Programs**
- 2. Offset data**
- 3. Parameters**
- 4. Custom macro common variables**

For how data is input and output, see III-8.

Parameter

Before an external input/output device can be used, parameters must be set as follows.

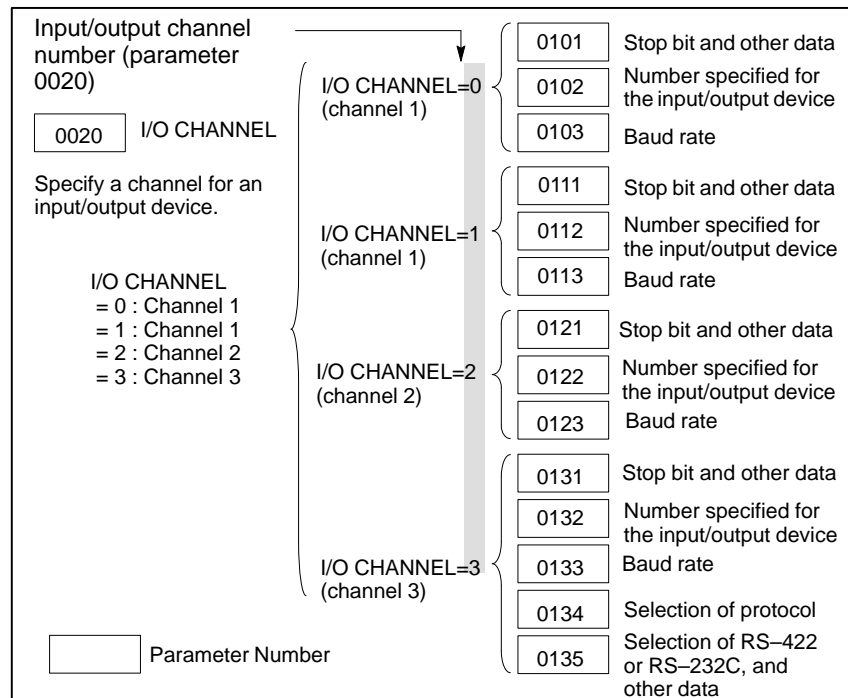


CNC has three channels of reader/punch interfaces. The input/output device to be used is specified by setting the channel connected to that device in setting parameter I/O CHANNEL.

The specified data, such as a baud rate and the number of stop bits, of an input/output device connected to a specific channel must be set in parameters for that channel in advance.

For channel 1, two combinations of parameters to specify the input/output device data are provided.

The following shows the interrelation between the reader/punch interface parameters for the channels.

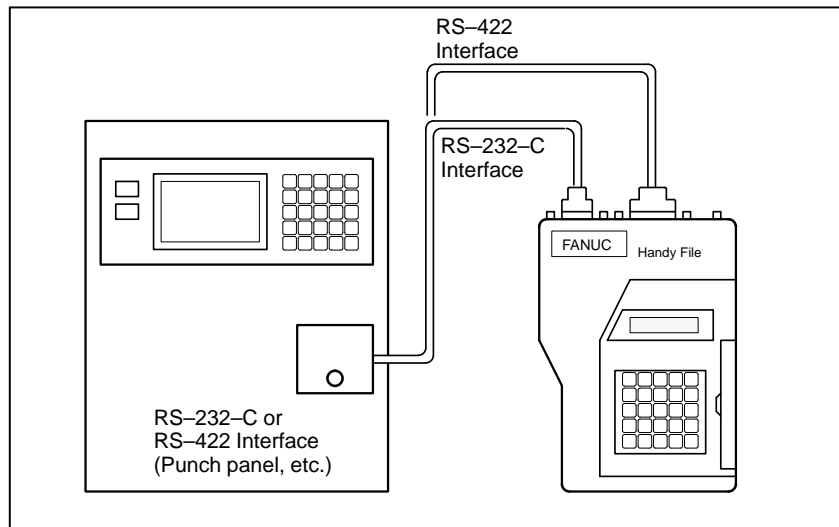


2.4.1 FANUC Handy File

The Handy File is an easy-to-use, multi function floppy disk input/output device designed for FA equipment. By operating the Handy File directly or remotely from a unit connected to the Handy File, programs can be transferred and edited.

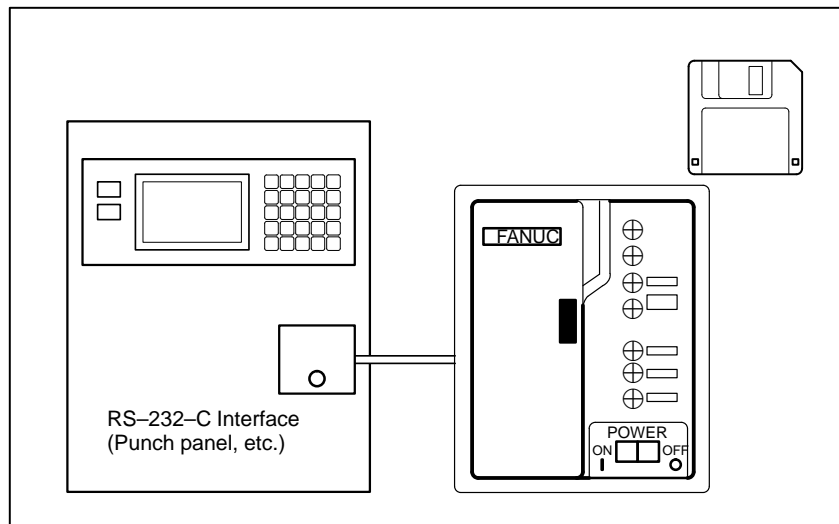
The Handy File uses 3.5-inch floppy disks, which do not have the problems of paper tape (i.e., noisy during input/output, easily broken, and bulky).

One or more programs (up to 1.44M bytes, which is equivalent to the memory capacity of 3600-m paper tape) can be stored on one floppy disk.



2.4.2 FANUC Floppy Cassette

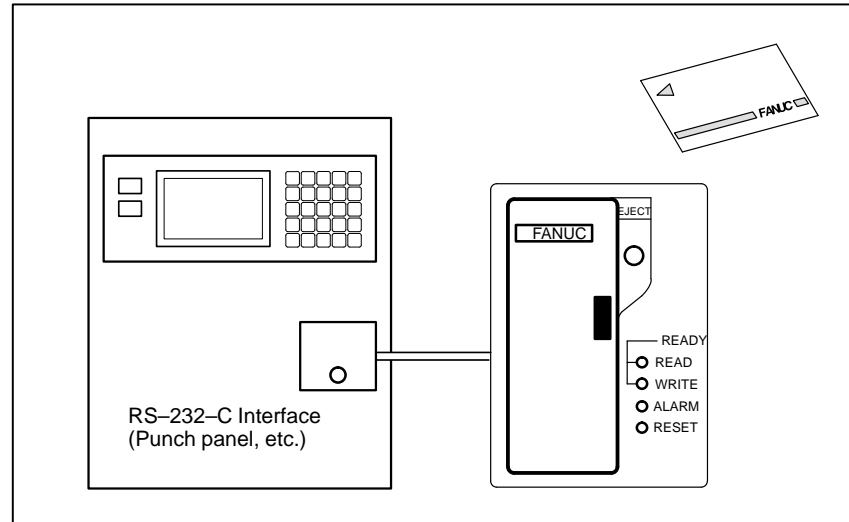
When the Floppy Cassette is connected to the CNC, machining programs stored in the CNC can be saved on a Floppy Cassette, and machining programs saved in the Floppy Cassette can be transferred to the CNC.



2.4.3 FANUC FA Card

An FA Card is a memory card used as an input medium in the FA field. It is compact, but has a large memory capacity with high reliability, and requires no special maintenance.

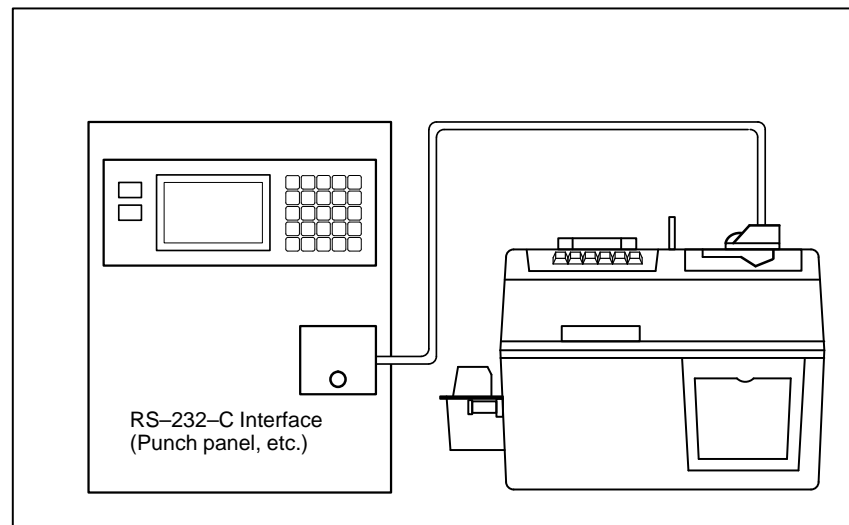
When an FA Card is connected to the CNC via the card adapter, machining programs stored in the CNC can be transferred to and saved in an FA Card. Machining programs stored on an FA Card can also be transferred to the CNC.



2.4.4 FANUC PPR

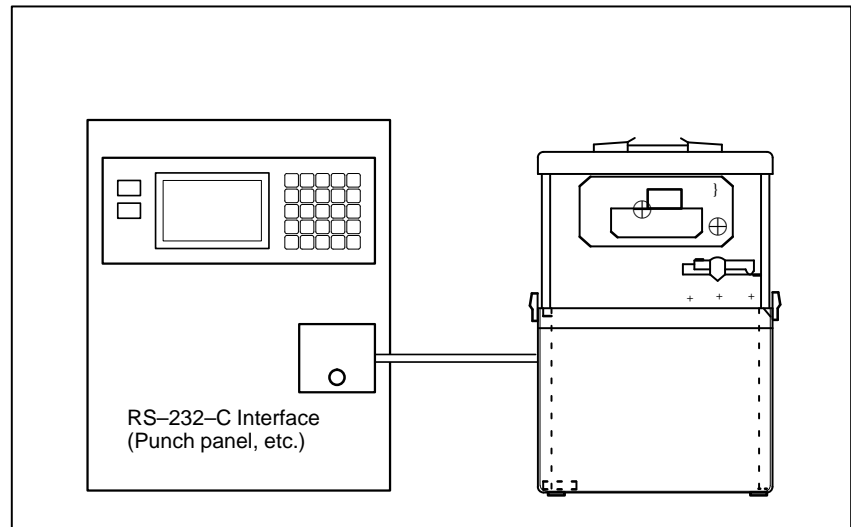
The FANUC PPR consists of three units: A printer, paper tape punch, and paper tape reader.

When the PPR is used alone, data can be read from the tape reader and printed or punched out. It is also possible to perform TH and TV checks on data that was read.



2.4.5 Portable Tape Reader

The portable tape reader is used to input data from paper tape.



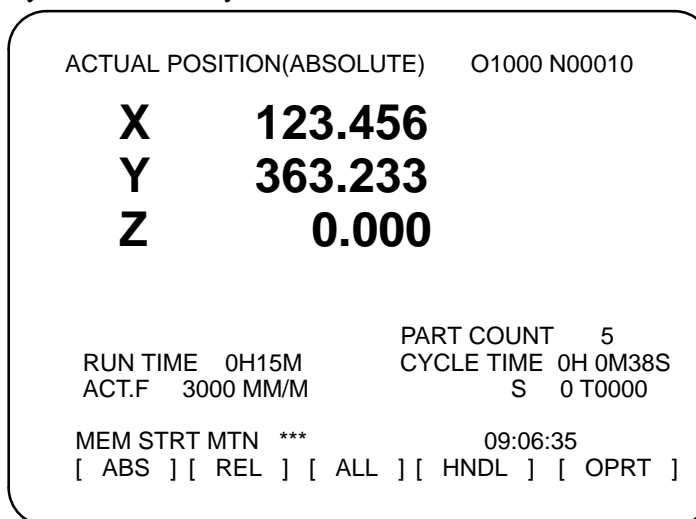
2.5 POWER ON/OFF

2.5.1 Turning on the Power

Procedure of turning on the power

Procedure

- 1 Check that the appearance of the CNC machine tool is normal. (For example, check that front door and rear door are closed.)
- 2 Turn on the power according to the manual issued by the machine tool builder.
- 3 After the power is turned on, check that the position screen is displayed. An alarm screen is displayed if an alarm occurs upon power-on. If the screen shown in Section III-2.5.2 is displayed, a system failure may have occurred.



- 4 Check that the fan motor is rotating.

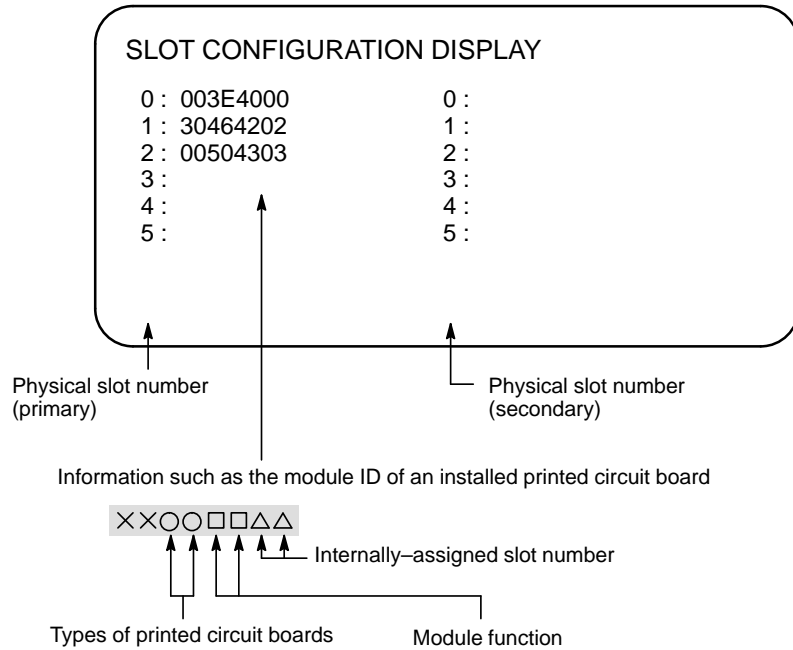
WARNING

Until the positional or alarm screen is displayed at the power on, do not touch them. Some keys are used for the maintenance or special operation purpose. When they are pressed, unexpected operation may be caused.

2.5.2 Screen Displayed at Power-on

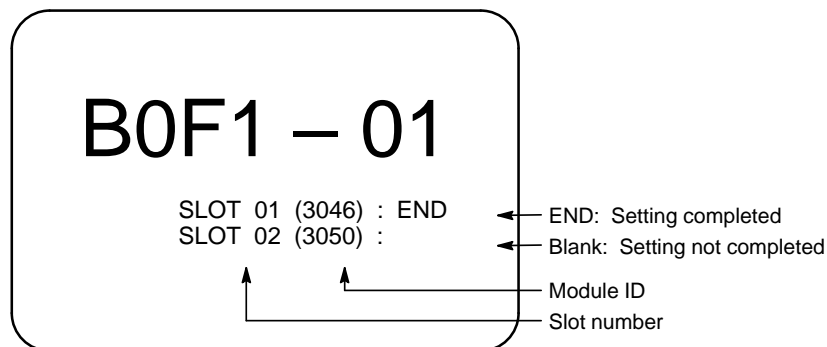
If a hardware failure or installation error occurs, the system displays one of the following three types of screens then stops. Information such as the type of printed circuit board installed in each slot is indicated. This information and the LED states are useful for failure recovery.

Slot status display

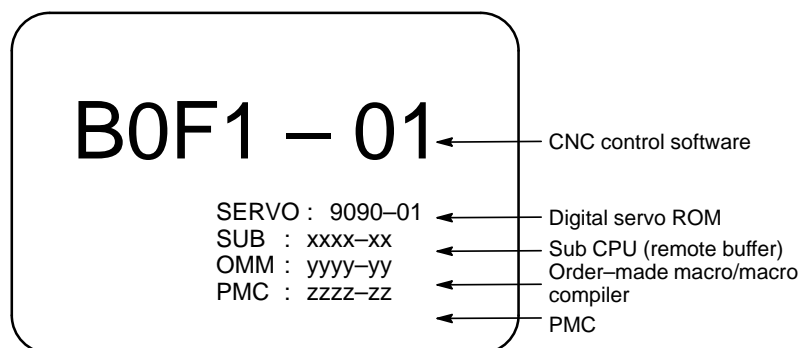


For more information about the types of printed circuit boards and module functions, refer to the maintenance manual (B-63005EN).

Screen indicating module setting status



Display of software configuration



The software configuration can be displayed on the system configuration screen also.

Refer to the MAINTENANCE MANUAL (B-63005EN) for the system configuration screen.

2.5.3 Power Disconnection

Power Disconnection

Procedure

- 1 Check that the LED indicating the cycle start is off on the operator's panel.
- 2 Check that all movable parts of the CNC machine tool is stopping.
- 3 If an external input/output device such as the Handy File is connected to the CNC, turn off the external input/output device.
- 4 Continue to press the POWER OFF pushbutton for about 5 seconds.
- 5 Refer to the machine tool builder's manual for turning off the power to the machine.

3

MANUAL OPERATION

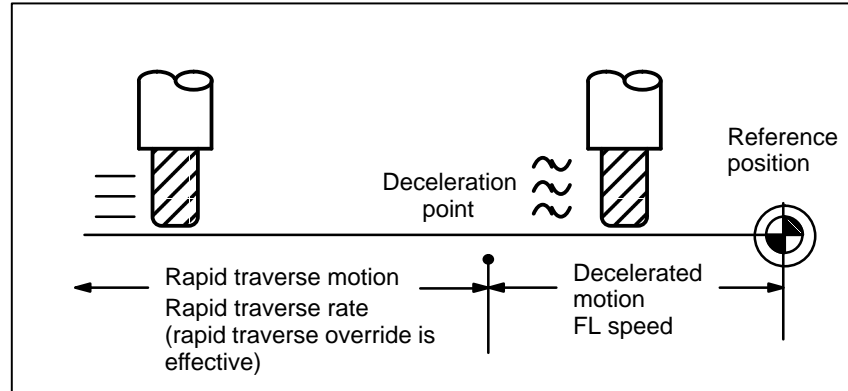
MANUAL OPERATION are six kinds as follows :

- 3.1 Manual reference position return
- 3.2 Jog feed
- 3.3 Incremental feed
- 3.4 Manual handle feed
- 3.5 Manual absolute on/off
- 3.6 Tool axis direction handle feed/Tool axis direction handle feed B

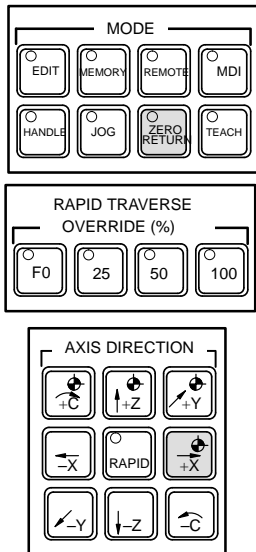
3.1 MANUAL REFERENCE POSITION RETURN

The tool is returned to the reference position as follows :
 The tool is moved in the direction specified in parameter ZMI (bit 5 of No. 1006) for each axis with the reference position return switch on the machine operator’s panel. The tool moves to the deceleration point at the rapid traverse rate, then moves to the reference position at the FL speed. The rapid traverse rate and FL speed are specified in parameters (No. 1420,1421, and 1425).

Fourstep rapid traverse override is effective during rapid traverse.
 When the tool has returned to the reference position, the reference position return completion LED goes on. The tool generally moves along only a single axis, but can move along three axes simultaneously when specified so in parameter JAX(bit 0 of No.1002).



Procedure for Manual Reference Position Return



1 Press the reference position return switch, one of the mode selection switches.

2 To decrease the feedrate, press a rapid traverse override switch. When the tool has returned to the reference position, the reference position return completion LED goes on.

3 Press the feed axis and direction selection switch corresponding to the axis and direction for reference position return. Continue pressing the switch until the tool returns to the reference position. The tool can be moved along three axes simultaneously when specified so in an appropriate parameter setting. The tool moves to the deceleration point at the rapid traverse rate, then moves to the reference position at the FL speed set in a parameter.

4 Perform the same operations for other axes, if necessary. The above is an example. Refer to the appropriate manual provided by the machine tool builder for the actual operations.

ZERO POSITION							MIRROR IMAGE		
X	Y	Z	C	X2	Y2	Z2	X	Y	Z
<input type="checkbox"/>	<input type="checkbox"/>	<input type="checkbox"/>	<input type="checkbox"/>	<input type="checkbox"/>	<input type="checkbox"/>	<input type="checkbox"/>	<input type="checkbox"/>	<input type="checkbox"/>	<input type="checkbox"/>
PRO-GRAM STOP	M02/M30	MANU ABS	SPINDLE ORI	TAP	ATC READY				MC?
<input type="checkbox"/>	<input type="checkbox"/>	<input type="checkbox"/>	<input type="checkbox"/>	<input type="checkbox"/>	<input type="checkbox"/>	<input type="checkbox"/>	<input type="checkbox"/>	<input type="checkbox"/>	<input type="checkbox"/>

Explanations

- **Automatically setting the coordinate system**

Bit 0 (ZPR) of parameter No. 1201 is used for automatically setting the coordinate system. When ZPR is set, the coordinate system is automatically determined when manual reference position return is performed.

When α , β and γ are set in parameter 1250, the workpiece coordinate system is determined so that reference point on the tool holder or the position of the tip of the reference tool is $X = \alpha$, $Y = \beta$, $Z = \gamma$ when reference position return is performed. This has the same effect as specifying the following command for reference position return:

`G92X α Y β Z γ ;`

However, when options of the workpiece coordinate system is selected, it is not able to use.

Restrictions

- **Moving the tool again**

Once the REFERENCE POSITION RETURN COMPLETION LED lights at the completion of reference position return, the tool does not move unless the REFERENCE POSITION RETURN switch is turned off.

- **Reference position return completion LED**

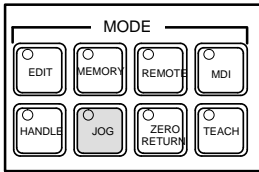
The REFERENCE POSITION RETURN COMPLETION LED is extinguished by either of the following operations:

- Moving from the reference position.
- Entering an emergency stop state.

- **The distance to return to reference position**

For the distance (Not in the deceleration condition) to return the tool to the reference position, refer to the manual issued by the machine tool builder.

3.2 JOG FEED



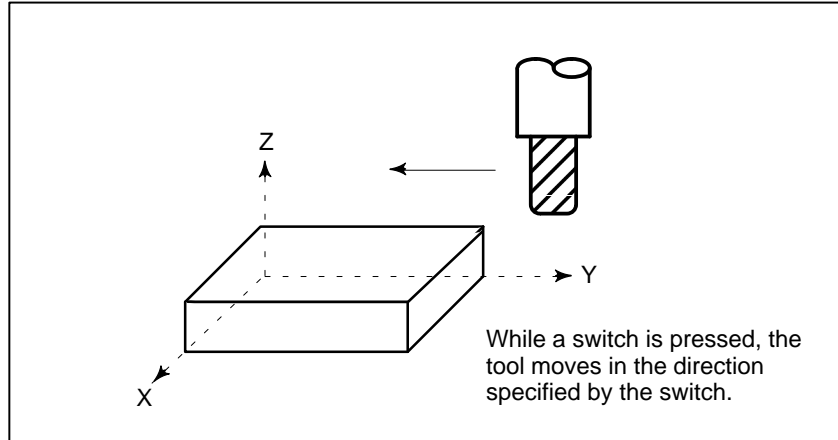
In the jog mode, pressing a feed axis and direction selection switch on the machine operator's panel continuously moves the tool along the selected axis in the selected direction.

The jog feedrate is specified in a parameter (No.1423)

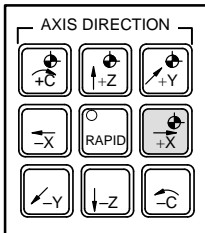
The jog feedrate can be adjusted with the jog feedrate override dial.

Pressing the rapid traverse switch moves the tool at the rapid traverse feedrate (No. 1424) regardless of the position of the jog feedrate override dial. This function is called the manual rapid traverse.

Manual operation is allowed for one axis at a time. 3 axes can be selected at a time by parameter JAX (No.1002#0).

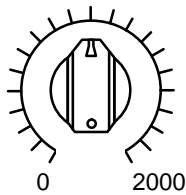


Procedure for JOG feed



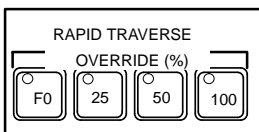
Procedure

- 1 Press the jog switch, one of the mode selection switches.
- 2 Press the feed axis and direction selection switch corresponding to the axis and direction the tool is to be moved. While the switch is pressed, the tool moves at the feedrate specified in a parameter (No. 1423). The tool stops when the switch is released.
- 3 The jog feedrate can be adjusted with the jog feedrate override dial.
- 4 Pressing the rapid traverse switch while pressing a feed axis and direction selection switch moves the tool at the rapid traverse rate while the rapid traverse switch is pressed. Rapid traverse override by the rapid traverse override switches is effective during rapid traverse.



JOG FEED RATE OVERRIDE

The above is an example. Refer to the appropriate manual provided by the machine tool builder for the actual operations.



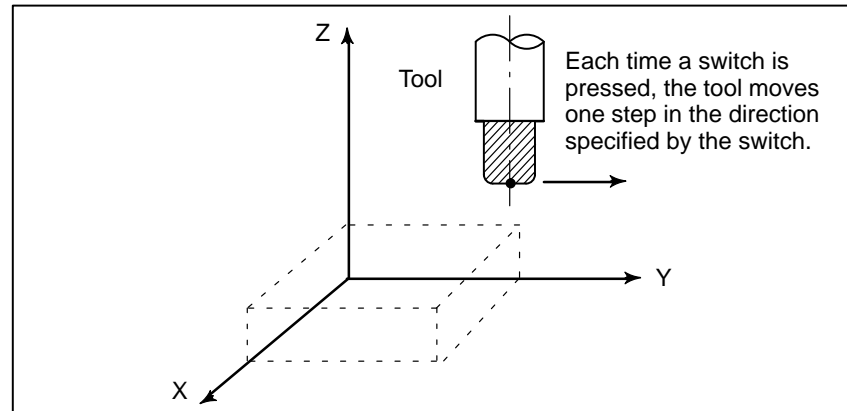
Limitations

- **Acceleration/deceleration for rapid traverse**
Feedrate, time constant and method of automatic acceleration/deceleration for manual rapid traverse are the same as G00 in programmed command.
- **Change of modes**
Changing the mode to the jog mode while pressing a feed axis and direction selection switch does not enable jog feed. To enable jog feed, enter the jog mode first, then press a feed axis and direction selection switch.
- **Rapid traverse prior to reference position return**
If reference position return is not performed after power-on, pushing RAPID TRAVERSE button does not actuate the rapid traverse but the remains at the JOG feedrate. This function can be disabled by setting parameter RPD (No.1401#01).

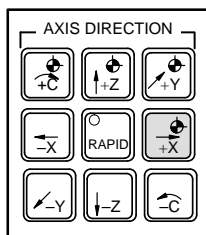
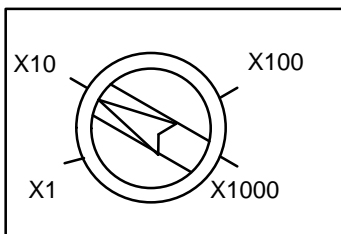
3.3 INCREMENTAL FEED

In the incremental (INC) mode, pressing a feed axis and direction selection switch on the machine operator's panel moves the tool one step along the selected axis in the selected direction. The minimum distance the tool is moved is the least input increment. Each step can be 10, 100, or 1000 times the least input increment.

This mode is effective when a manual pulse generator is not connected.



Procedure for Incremental Feed



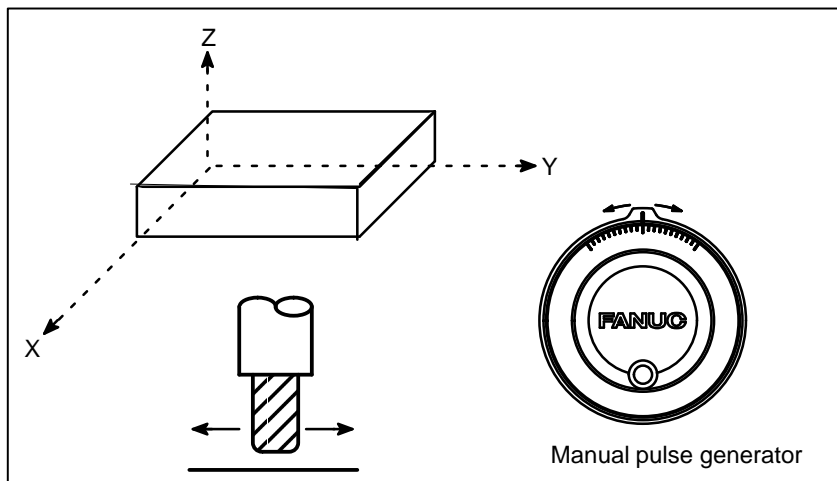
- 1 Press the INC switch, one of the mode selection switches.
- 2 Select the distance to be moved for each step with the magnification dial.
- 3 Press the feed axis and direction selection switch corresponding to the axis and direction the tool is to be moved. Each time a switch is pressed, the tool moves one step. The feedrate is the same as the jog feedrate.
- 4 Pressing the rapid traverse switch while pressing a feed axis and direction selection switch moves the tool at the rapid traverse rate. Rapid traverse override by the rapid traverse override switch is effective during rapid traverse.

The above is an example. Refer to the appropriate manual provided by the machine tool builder for the actual operations.

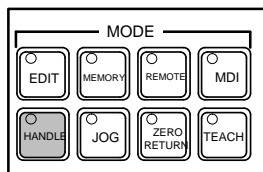
3.4 MANUAL HANDLE FEED

In the handle mode, the tool can be minutely moved by rotating the manual pulse generator on the machine operator's panel. Select the axis along which the tool is to be moved with the handle feed axis selection switches.

The minimum distance the tool is moved when the manual pulse generator is rotated by one graduation is equal to the least input increment. Or the distance the tool is moved when the manual pulse generator is rotated by one graduation can be magnified by 10 times or by one of the two magnifications specified by parameters (No. 7113 and 7114).



Procedure for Manual Handle Feed



Manual pulse generator

- 1 Press the HANDLE switch, one of the mode selection switches.
- 2 Select the axis along which the tool is to be moved by pressing a handle feed axis selection switch.
- 3 Select the magnification for the distance the tool is to be moved by pressing a handle feed magnification switch. The minimum distance the tool is moved when the manual pulse generator is rotated by one graduation is equal to the least input increment.
- 4 Move the tool along the selected axis by rotating the handle. Rotating the handle 360 degrees moves the tool the distance equivalent to 100 graduations.
The above is an example. Refer to the appropriate manual provided by the machine tool builder for the actual operations.

Explanations

- **Availability of manual pulse generator in Jog mode (JHD)**

Parameter JHD (bit 0 of No. 7100) enables or disables the manual handle feed in the JOG mode.
When the parameter JHD(bit 0 of No. 7100) is set 1,both manual handle feed and incremental feed are enabled.
- **Availability of manual pulse generator in TEACH IN JOG mode (THD)**

Parameter THD (bit 1 of No. 7100) enables or disables the manual handle feed in the TEACH IN JOG mode.
- **A command to the MPG exceeding rapid traverse rate (HPF)**

Parameter HPF (bit 4 of No. 7100) or (No. 7117) specifies as follows:

 - Parameter HPF (bit 4 of No. 7100)

Set value 0 : The feedrate is clamped at the rapid traverse rate and generated pulses exceeding the rapid traverse rate are ignored.(The distance the tool is moved may not match the graduations on the manual pulse generator.)

Set value 1 : The feedrate is clamped at the rapid traverse rate and generated pulses exceeding the rapid traverse rate are not ignored but accumulated in the CNC.
(No longer rotating the handle does not immediately stop the tool. The tool is moved by the pulses accumulated in the CNC before it stops.)
 - Parameter HPF (No. 7117) (It is available when parameter HPF is 0.)

Set value 0 : The feedrate is clamped at the rapid traverse rate and generated pulses exceeding the rapid traverse rate are ignored.(The distance the tool is moved may not match the graduations on the manual pulse generator.)

Other than 0 : The feedrate is clamped at the rapid traverse rate and generated pulses exceeding the rapid traverse rate are not ignored but accumulated in the CNC until the limit specified in parameter No. 7117 is reached.
(No longer rotating the handle does not immediately stop the tool. The tool is moved by the pulses accumulated in the CNC before it stops.)
- **Movement direction of an axis to the rotation of MPG (HNG_x)**

Parameter HNG_x (No. 7102 #0) switches the direction of MPG in which the tool moves along an axis, corresponding to the direction in which the handle of the manual pulse generator is rotated.

Restrictions

- **Number of MPGs**

Up to three manual pulse generators can be connected, one for each axis. The three manual pulse generators can be simultaneously operated.

WARNING

Rotating the handle quickly with a large magnification such as x100 moves the tool too fast. The feedrate is clamped at the rapid traverse feedrate.

NOTE

Rotate the manual pulse generator at a rate of five rotations per second or lower. If the manual pulse generator is rotated at a rate higher than five rotations per second, the tool may not stop immediately after the handle is no longer rotated or the distance the tool moves may not match the graduations on the manual pulse generator.

3.5 MANUAL ABSOLUTE ON AND OFF

Whether the distance the tool is moved by manual operation is added to the coordinates can be selected by turning the manual absolute switch on or off on the machine operator's panel. When the switch is turned on, the distance the tool is moved by manual operation is added to the coordinates. When the switch is turned off, the distance the tool is moved by manual operation is not added to the coordinates.

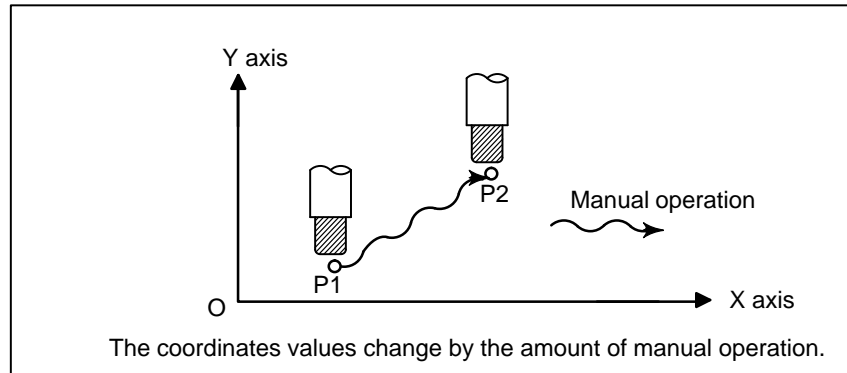


Fig. 3.5(a) Coordinates with the switch ON

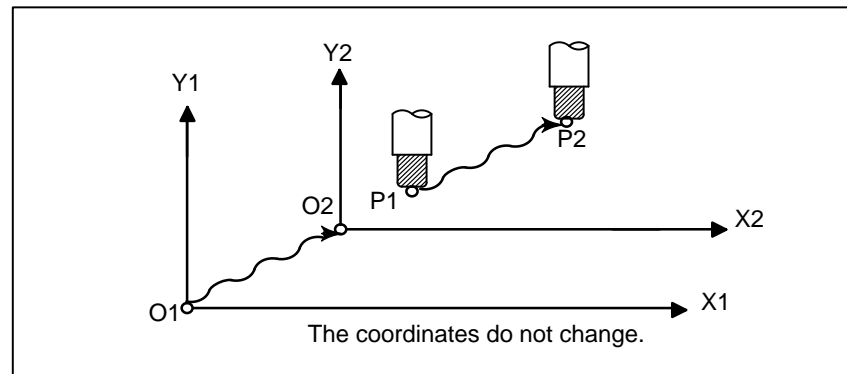


Fig. 3.5(b) Coordinates with the switch OFF

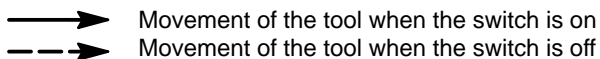
Explanation

The following describes the relation between manual operation and coordinates when the manual absolute switch is turned on or off, using a program example.

```

G01G90 X100.0Y100.0F010 ; ①
X200.0Y150.0 ; ②
X300.0Y200.0 ; ③
    
```

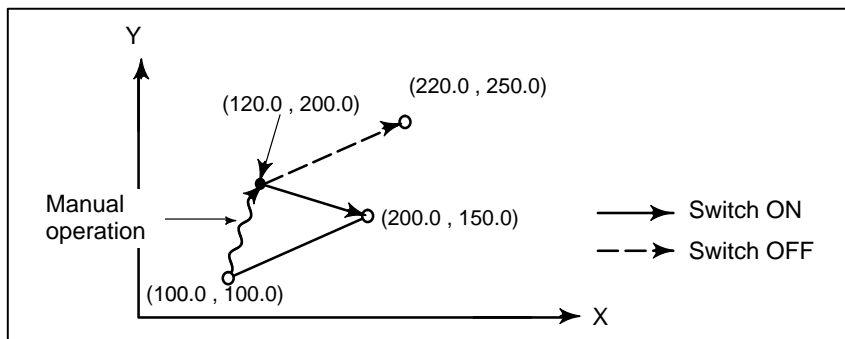
The subsequent figures use the following notation:



The coordinates after manual operation include the distance the tool is moved by the manual operation. When the switch is off, therefore, subtract the distance the tool is moved by the manual operation.

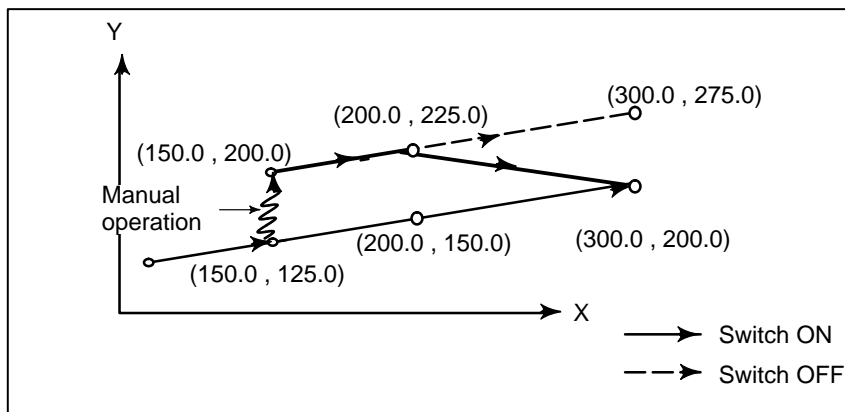
● **Manual operation after the end of block**

Coordinates when block ② has been executed after manual operation (X-axis +20.0, Y-axis +100.0) at the end of movement of block.



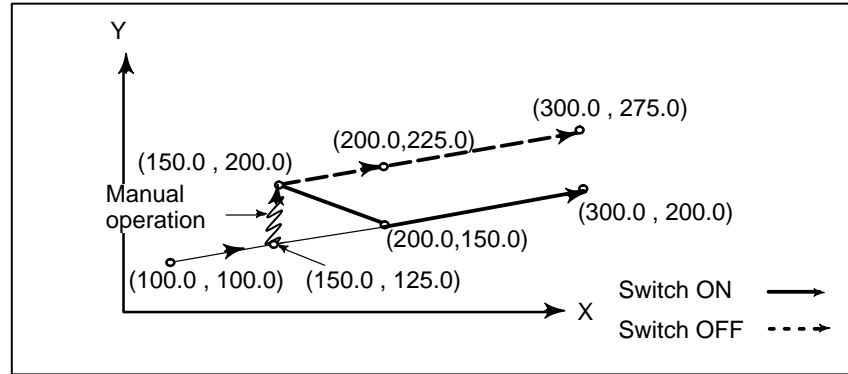
● **Manual operation after a feed hold**

Coordinates when the feed hold button is pressed while block ② is being executed, manual operation (Y-axis + 75.0) is performed, and the cycle start button is pressed and released.



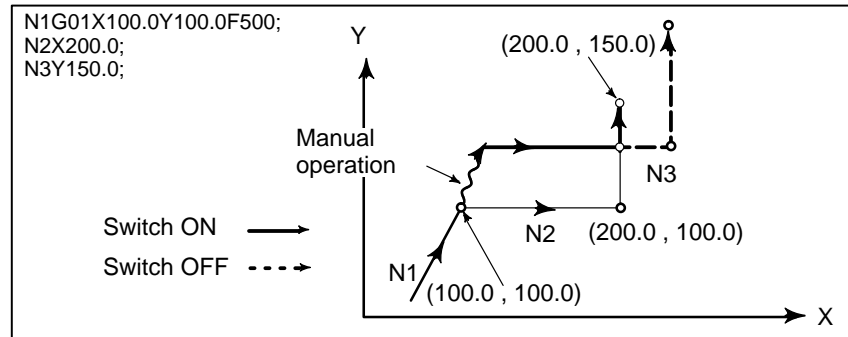
- **When reset after a manual operation following a feed hold**

Coordinates when the feed hold button is pressed while block [2] is being executed, manual operation (Y-axis +75.0) is performed, the control unit is reset with the RESET button, and block [2] is read again



- **When a movement command in the next block is only one axis**

When there is only one axis in the following command, only the commanded axis returns.

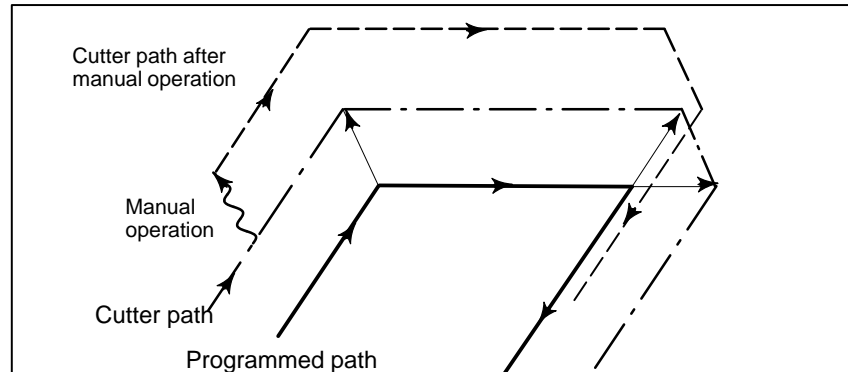


- **When the next move block is an incremental**
- **Manual operation during cutter compensation**

When the following commands are incremental commands, operation is the same as when the switch is OFF.

When the switch is OFF

After manual operation is performed with the switch OFF during cutter compensation, automatic operation is restarted then the tool moves parallel to the movement that would have been performed if manual movement had not been performed. The amount of separation equals to the amount that was performed manually.

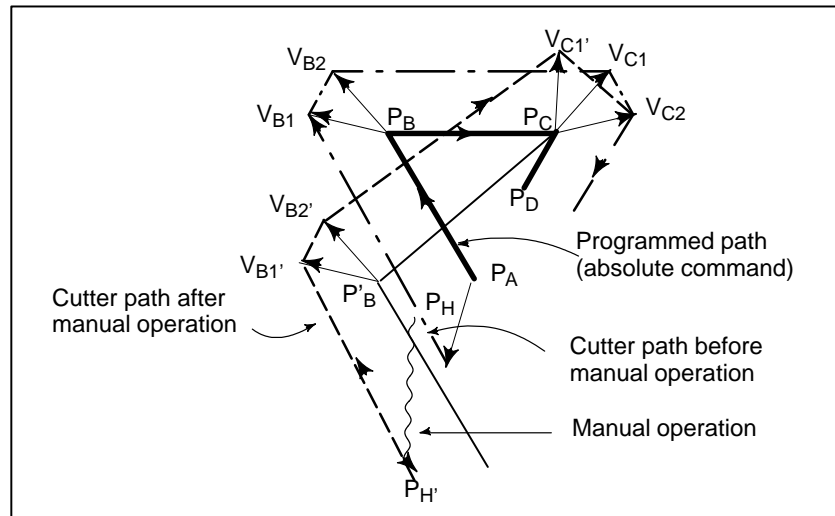


When the switch is ON during cutter compensation

Operation of the machine upon return to automatic operation after manual intervention with the switch is ON during execution with an absolute command program in the cutter compensation mode will be described. The vector created from the remaining part of the current block and the beginning of the next block is shifted in parallel. A new vector is created based on the next block, the block following the next block and the amount of manual movement. This also applies when manual operation is performed during cornering.

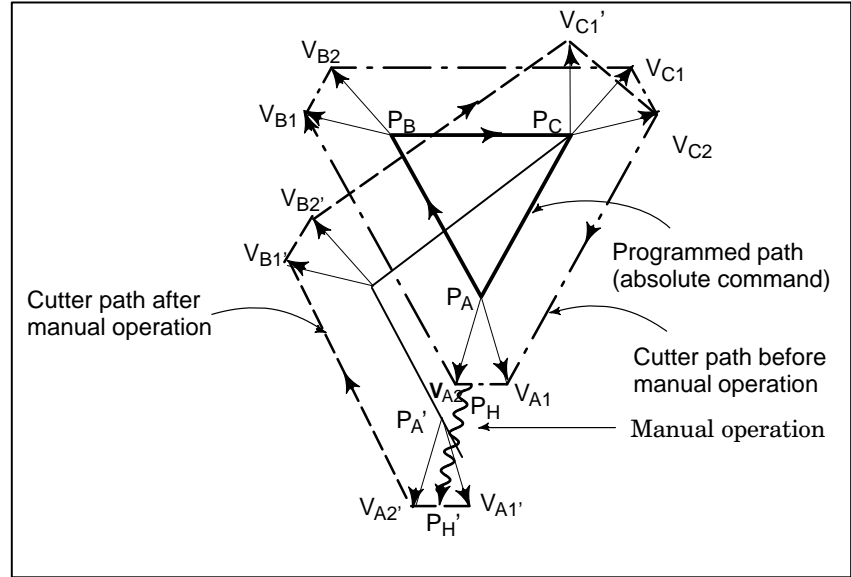
Manual operation performed in other than cornering

Assume that the feed hold was applied at point P_H while moving from P_A to P_B of programmed path P_A , P_B , and P_C and that the tool was manually moved to $P_{H'}$. The block end point P_B moves to the point $P_{B'}$ by the amount of manual movement, and vectors V_{B1} and V_{B2} at P_B also move to $V_{B1'}$ and $V_{B2'}$. Vectors V_{C1} and V_{C2} between the next two blocks $P_B - P_C$ and $P_C - P_D$ are discarded and new vectors $V_{C1'}$ and $V_{C2'}$ ($V_{C2'} = V_{C2}$ in this example) are produced from the relation between $P_{B'} - P_C$ and $P_C - P_D$. However, since $V_{B2'}$ is not a newly calculated vector, correct offset is not performed at block $P_{B'} - P_C$. Offset is correctly performed after P_C .



Manual operation during cornering

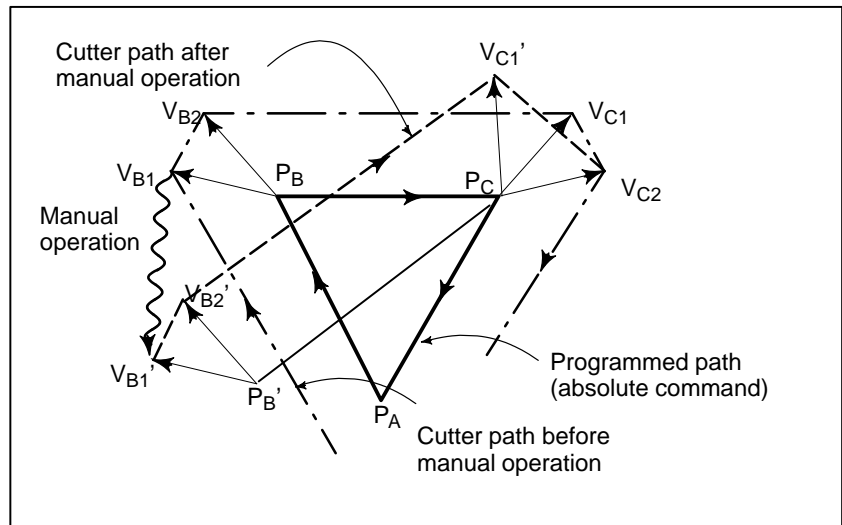
This is an example when manual operation is performed during cornering. $V_{A2'}$, $V_{B1'}$, and $V_{B2'}$ are vectors moved in parallel with V_{A2} , V_{B1} and V_{B2} by the amount of manual movement. The new vectors are calculated from V_{C1} and V_{C2} . Then correct cutter compensation is performed for the blocks following P_C .



Manual operation after single block stop

Manual operation was performed when execution of a block was terminated by single block stop.

Vectors V_{B1} and V_{B2} are shifted by the amount of manual operation. Subsequent processing is the same as case a described above. An MDI operation can also be interveneted as well as manual operation. The movement is the same as that by manual operation.



3.6 TOOL AXIS DIRECTION HANDLE FEED/TOOL AXIS DIRECTION HANDLE FEED B

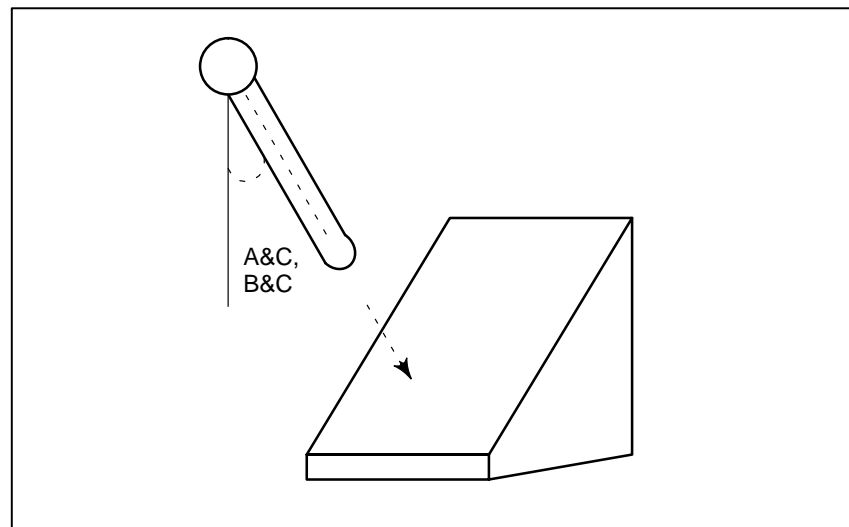
Tool axis direction handle feed moves the tool over a specified distance by handle feed in the direction of the tool axis tilted by the rotation of the rotary axis.

Tool axis direction handle feed B has the function of tool axis direction handle feed, and also has the tool axis normal direction handle feed which is handle feed at right angles to the tool axis.

These functions are used, for example, with 5-axis engraving machines.

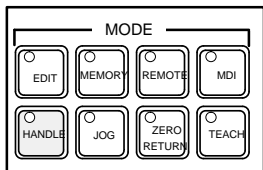
3.6.1 Tool Axis Direction Handle Feed

When the tool axis direction handle mode is selected and the manual pulse generator is rotated, the tool is moved by the specified travel distance in the direction of the tool axis tilted by the rotation of the rotary axis.



Tool Axis Normal Direction Handle Feed

Procedure



- 1 Select the HANDLE switch from the mode selection switches.
- 2 Select the tool axis direction handle feed switch.
- 3 Select the tool axis direction handle feed mode axis as the handle feed axis for the first manual pulse coder (parameter No. 7121).
- 4 When the handle is turned, the tool moves in the tool axis direction by the corresponding distance.

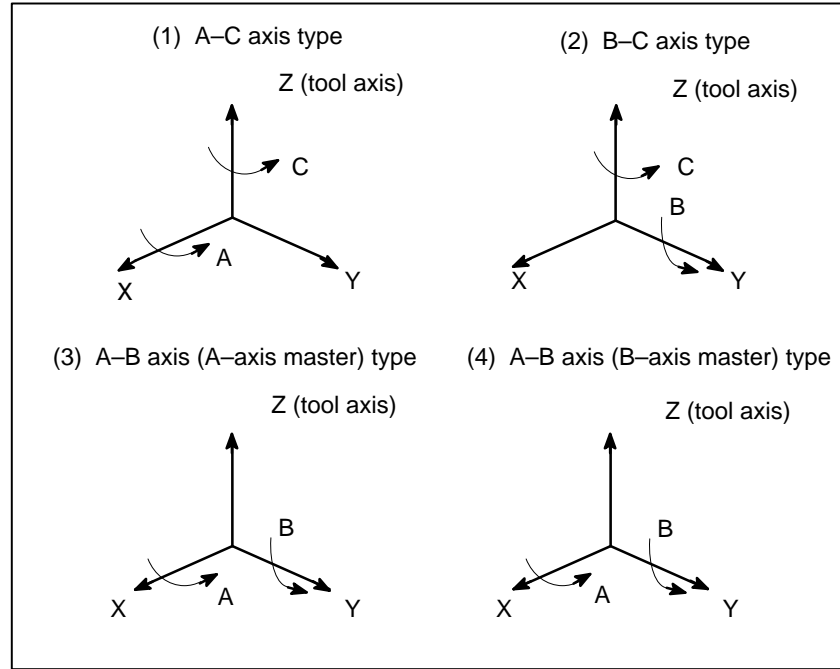
When both the tool axis direction handle feed mode and tool axis right-angle direction handle feed mode are selected, neither mode is set, but the ordinary handle mode is set.

The procedure above is only an example. Refer to the relevant manual published by the machine tool builder for other possible operations.

Explanations

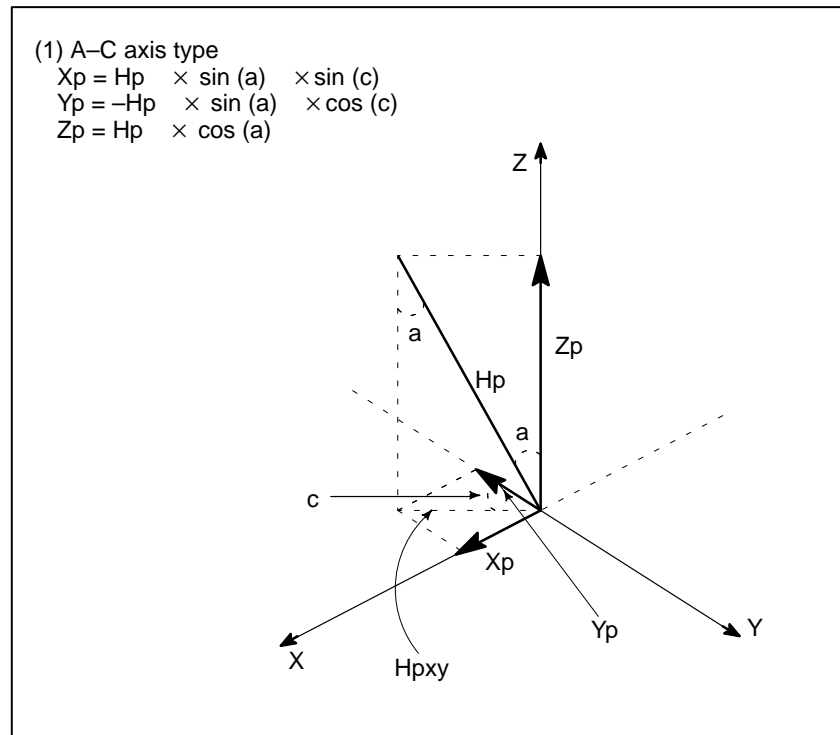
• **Axis configuration**

Assume that the rotary axes for basic axes X, Y, and Z are A, B, and C, respectively. Assume also that the Z-axis represents the tool axis. Depending on the axis configuration of the machine, four types of tool axis directions are available. Specify the direction with parameter No. 7120.

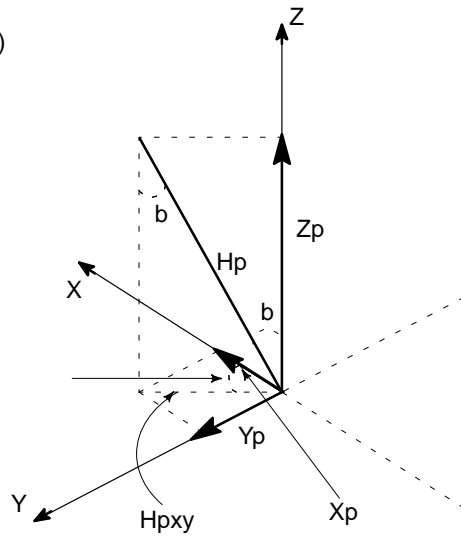


• **Pulse distribution to basic axes**

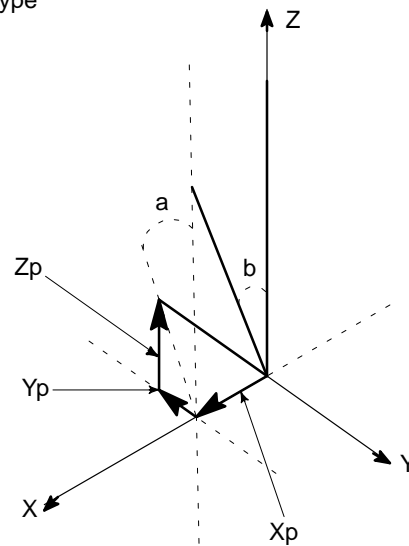
The figure below shows handle pulse (H_p) distribution to the X-axis, Y-axis, and Z-axis for each of the four directions.



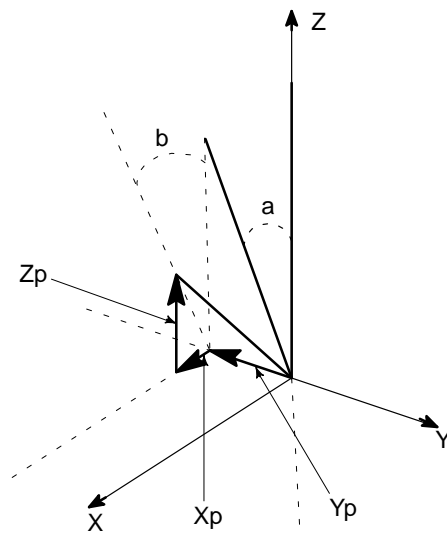
- (2) B-C axis type
 $X_p = H_p \times \sin(b) \times \cos(c)$
 $Y_p = H_p \times \sin(b) \times \sin(c)$
 $Z_p = H_p \times \cos(b)$



- (3) A-B axis (A axis master) type
 $X_p = H_p \times \sin(b)$
 $Y_p = -H_p \times \cos(b) \times \sin(a)$
 $Z_p = H_p \times \cos(b) \times \cos(a)$



- (4) A-B axis (B axis master) type
 $X_p = H_p \times \cos(a) \times \sin(b)$
 $Y_p = -H_p \times \sin(a)$
 $Z_p = H_p \times \cos(a) \times \cos(b)$



In the figures above, a, b, and c represent the positions (angles) of the A-axis, B-axis, and C-axis from the machine zero point; those values present when the tool axis direction handle feed mode is set or a reset occurs are used. To change the feed direction, reenter the tool axis direction handle feed mode, or press the reset key.

For tool axis direction determination, the coordinates (rotation angles) of rotary axes can be set using bits 3 and 4 (3D1X and 3D2X) of parameter No. 7104, and parameter Nos. 7144 and 7145.

- **Setting basic axes and rotary axes**

Basic axes X, Y, and Z are determined by parameter No. 1022 (plane selection). Rotary axes A, B, and C are determined by parameter No. 1020 (axis name).

- **Tool axis direction**

The direction of the tool X axis is determined by setting bit 0 (TLX) of parameter No. 7104.

- **Setting for 4-axis machines**

This function is usually used with 5-axis machines. However, 4-axis machines (One axis is for rotation) can be used by setting bit 2 (CXC) of parameter No. 7104 to 1.

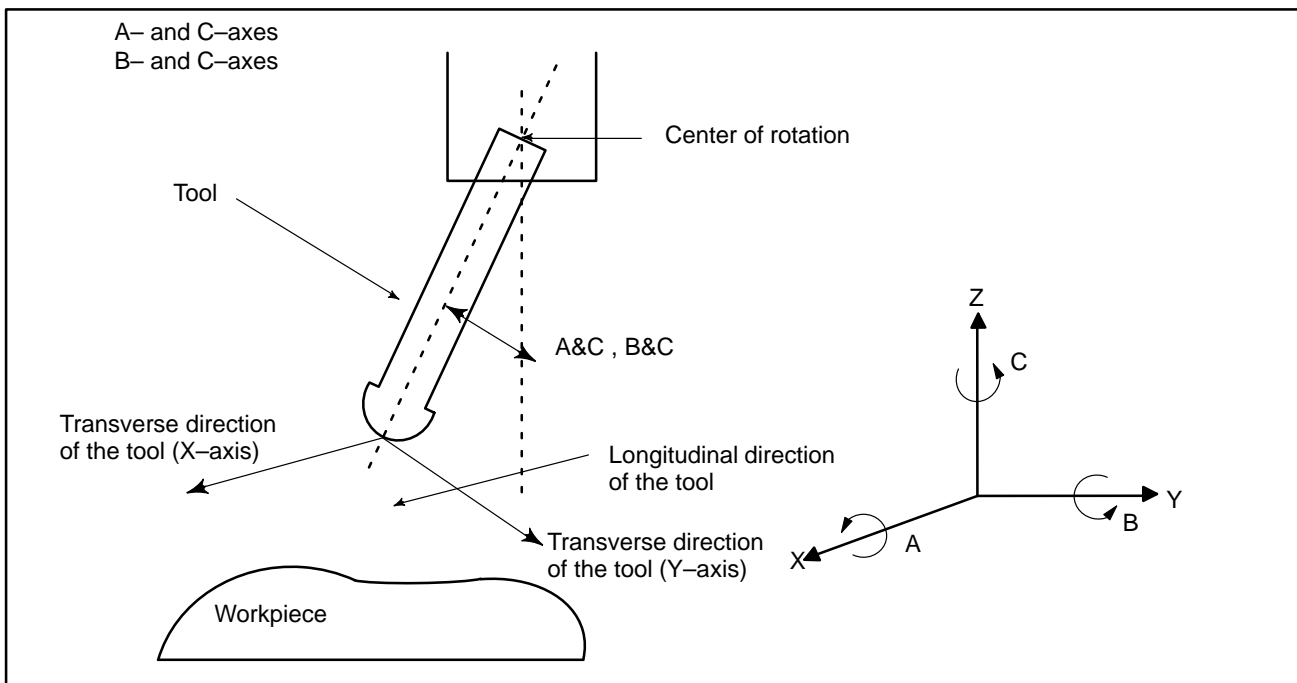
Restrictions

- **Axis configuration**

If either of the two axes selected in type specification based on the axis configuration is nonexistent as an axis, P/S alarm No. 5015 is issued.

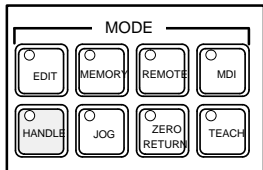
3.6.2 Tool Axis Normal Direction Handle Feed

When the tool axis normal direction handle mode is selected and the manual pulse generator is rotated, the tool is moved by the specified travel distance in the direction normal to the tool axis tilted by the rotation of the rotary axis.



Tool Axis Direction Handle Feed

Procedure



- 1 Select the HANDLE switch from the mode selection switches.
- 2 Select the tool axis normal direction handle feed switch.
- 3 Select the tool axis direction handle feed mode axis as the handle feed axis for the first manual pulse coder (parameter No. 7141, No. 7142).
- 4 When the handle is turned, the tool moves in normal direction to the tool axis direction by the corresponding distance.

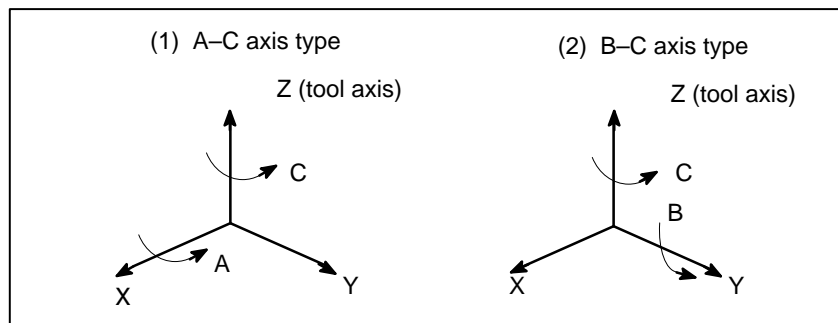
When both the tool axis direction handle feed mode and tool axis right-angle direction handle feed mode are selected, neither mode is set, but the ordinary handle mode is set.

The procedure above is only an example. Refer to the relevant manual published by the machine tool builder for other possible operations.

Explanations

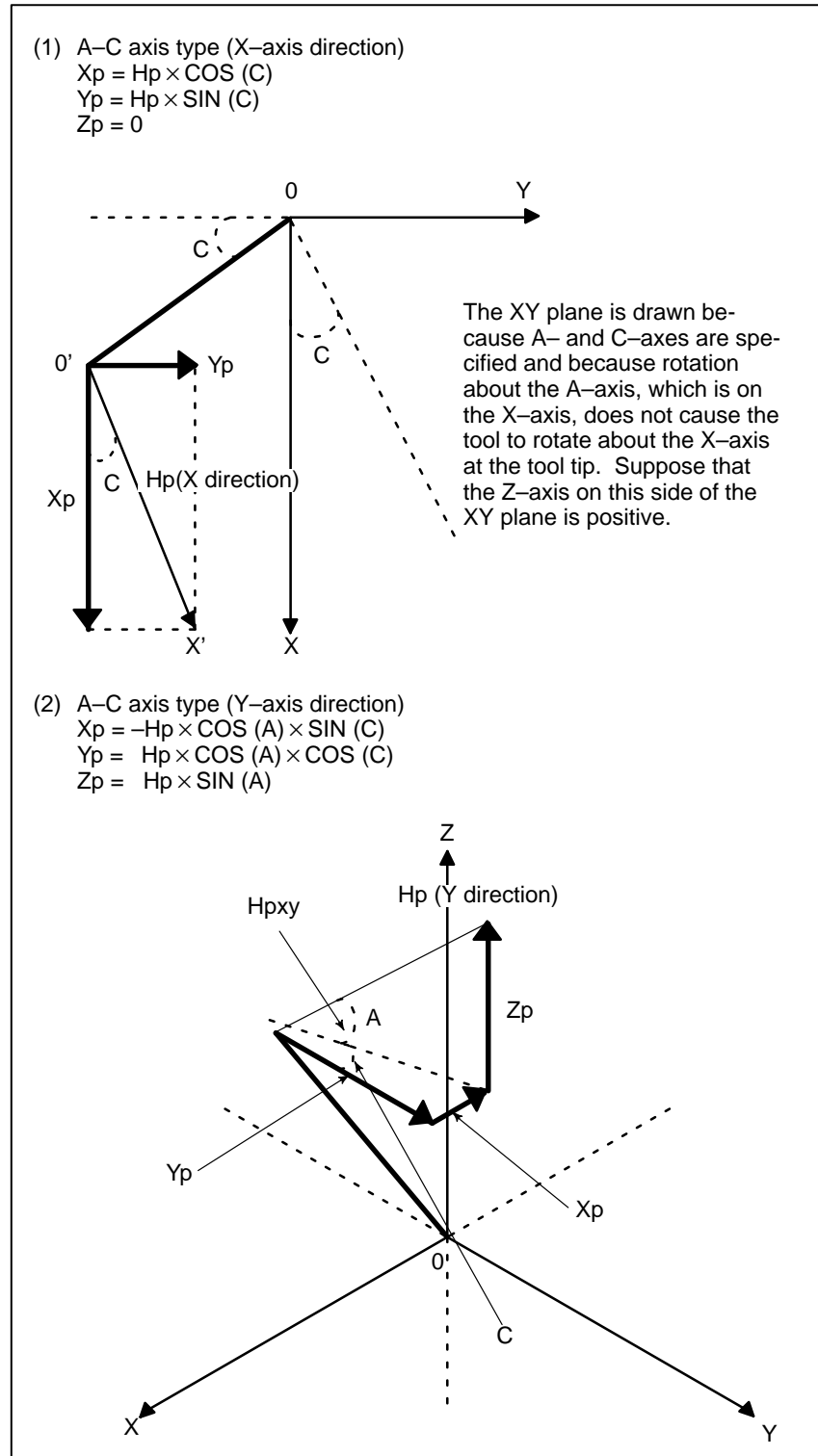
- **Axis configuration**

Assume that the rotary axes for basic axes X, Y, and Z are A, B, and C, respectively. Assume also that the Z-axis represents the tool axis. Depending on the axis configuration of the machine, two types of tool axis directions in which X-axis direction and Y-axis direction are available. Specify the direction with parameter No. 7120.

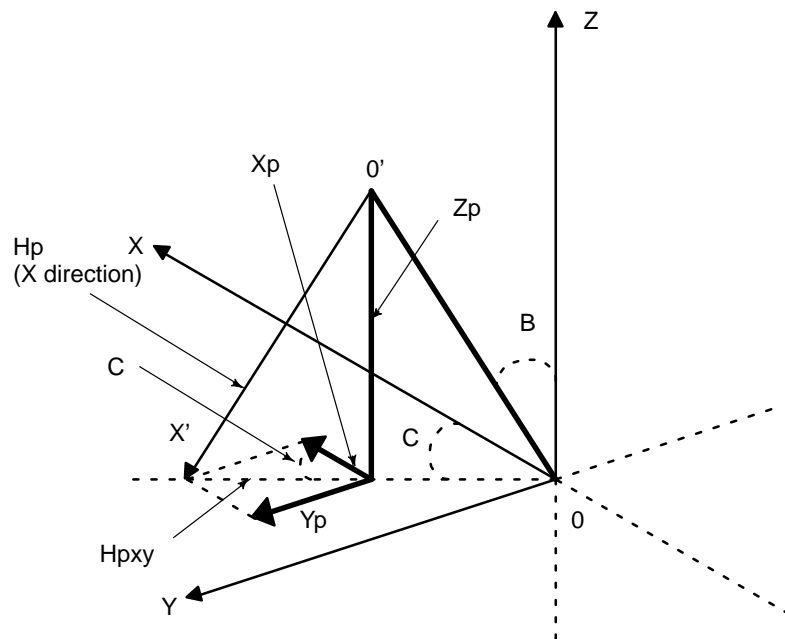


● **Pulse distribution to basic axes**

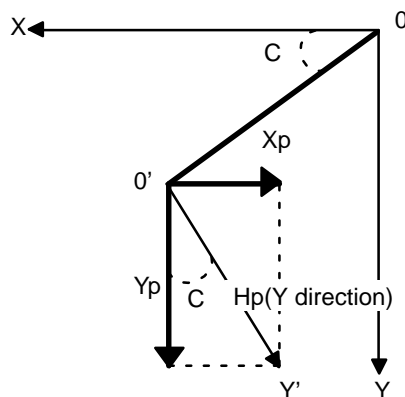
The figure below shows handle pulse (H_p) distribution to the X-axis, Y-axis, and Z-axis for each of the four directions.



- (3) B-C axis type (X-axis direction)
 $X_p = H_p \times \cos(B) \times \cos(C)$
 $Y_p = H_p \times \cos(B) \times \sin(C)$
 $Z_p = -H_p \times \sin(B)$



- (4) B-C axis type (Y-axis direction)
 $X_p = -H_p \times \sin(C)$
 $Y_p = H_p \times \cos(C)$
 $Z_p = 0$



The XY plane is drawn because B- and C-axes are specified and because rotation about the B-axis, which is on the Y-axis, does not cause the tool to rotate about the Y-axis at the tool tip. Suppose that the Z-axis on this side of the XY plane is positive.

In the figures above, a, b, and c represent the positions (angles) of the A-axis, B-axis, and C-axis from the machine zero point; those values present when the tool axis direction handle feed mode is set or a reset occurs are used. To change the feed direction, reenter the tool axis direction handle feed mode, or press the reset key.

For tool axis direction determination, the coordinates (rotation angles) of rotary axes can be set using bits 3 and 4 (3D1X and 3D2X) of parameter No. 7104, and parameter Nos. 7144 and 7145.

- **Setting basic axes and rotary axes**
Basic axes X, Y, and Z are determined by parameter No. 1022 (plane selection). Rotary axes A, B, and C are determined by parameter No. 1020 (axis name).
- **Tool axis direction**
The direction of the tool X axis is determined by setting bit 0 (TLX) of parameter No. 7104.
- **Setting for 4-axis machines**
This function is usually used with 5-axis machines. However, 4-axis machines (One axis is for rotation) can be used by setting bit 2 (CXC) of parameter No. 7104 to 1.

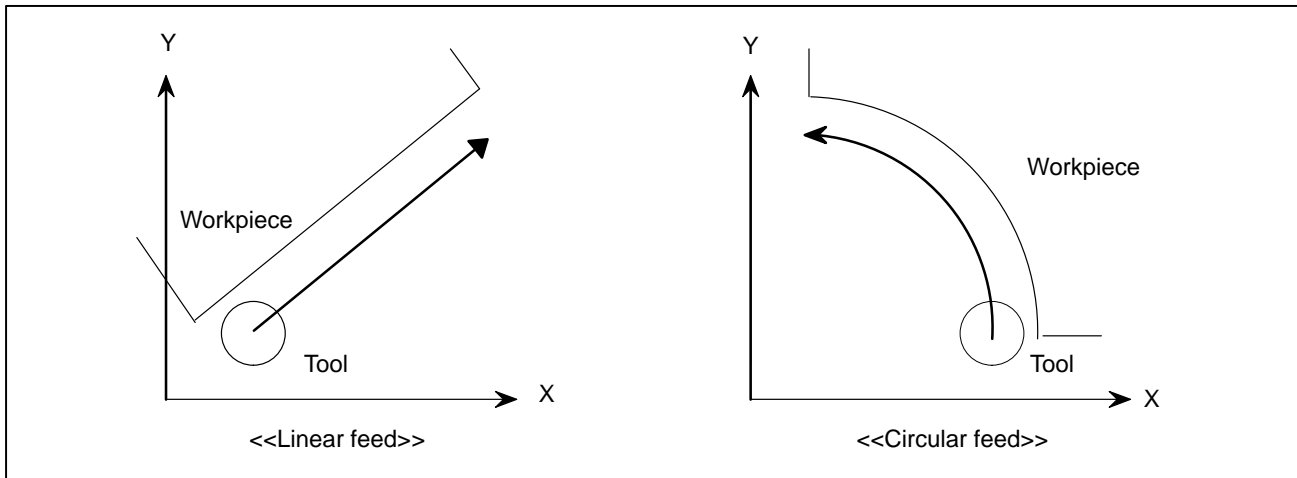
Restrictions

- **Axis configuration**
If either of the two axes selected in type specification based on the axis configuration is nonexistent as an axis, P/S alarm No. 5015 is issued. Moreover, the A-C axis type or B-C axis type must be selected as the axis configuration type.

3.7 MANUAL LINEAR/CIRCULAR INTERPOLATION

In manual handle feed or jog feed, the following types of feed operations are enabled in addition to the conventional feed operation along a specified single axis (X-axis, Y-axis, Z-axis, and so forth) based on simultaneous 1-axis control:

- Feed along a tilted straight line in the XY plane (linear feed) based on simultaneous 2-axis control
- Feed along a circle in the XY plane (circular feed) based on simultaneous 2-axis control



NOTE

The X-axis and Y-axis must be the first controlled axis and second controlled axis, respectively.

Procedure for Manual Linear/Circular Interpolation

Procedure

- 1 To perform manual handle feed, select manual handle feed mode. To perform jog feed, select jog feed mode.
- 2 To perform manual handle feed, select a feed axis (for simultaneous 1-axis feed along the X-axis, Y-axis, or Z-axis, or for simultaneous linear or circular 2-axis feed along a specified straight line or circle in the XY plane) subject to manual handle feed operation. Use the handle feed axis select switch for this selection.
To perform jog feed, select a feed axis and direction with the feed axis direction select switch. While a feed axis and its direction are specified, the tool moves in the specified axis direction or along a straight line or circle at the jog feedrate specified in parameter No. 1423.
- 3 For manual handle feed

The tool is moved along a specified axis by turning the respective manual handle. The feedrate depends on the speed at which the manual handle is turned. A distance to be traveled by the tool when the manual handle is turned by one pulse can be selected using the manual handle feed travel distance magnification switch.

For jog feed

The feedrate can be overridden using the manual feedrate override dial.

The procedure above is just an example. For actual operations, refer to the relevant manual provided by the machine tool builder.

Explanations

- **Definition of a straight line/circle**

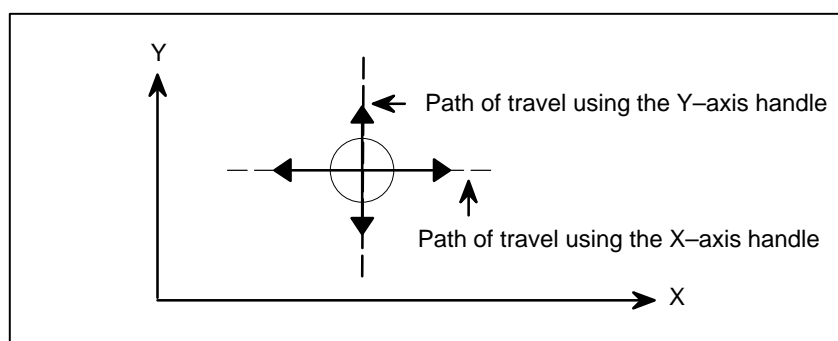
For feed along an axis, no straight line/circle definition is required. For linear feed or circular feed, a straight line or circle must be defined beforehand. (For circular feed, for example, data such as a radius and the center of a circle must be set.) For details, refer to the relevant manual provided by the machine tool builder.

- **Manual handle feed**

In manual handle feed, the tool can be moved along a specified axis (X-axis, Y-axis, Z-axis, ..., or the 8th axis), or can be moved along a tilted straight line (linear feed) or a circle (circular feed).

(1) Feed along a specified axis (simultaneous 1-axis control)

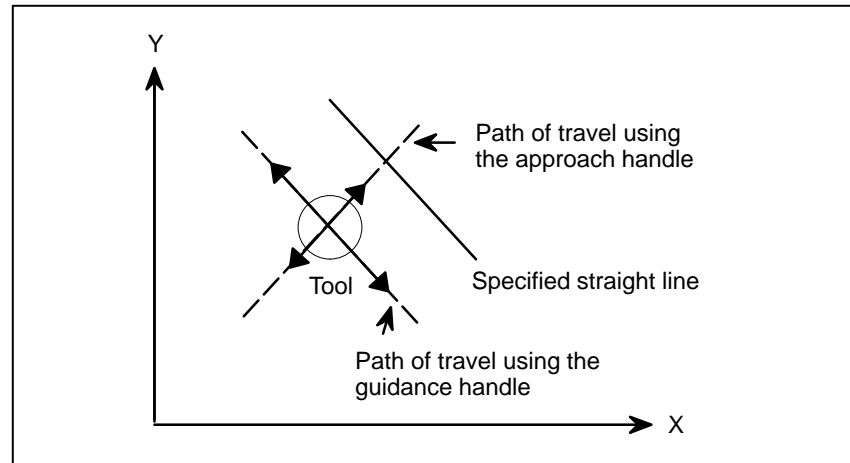
By turning a manual handle, the tool can be moved along the desired axis (such as X-axis, Y-axis, and Z-axis) on a simultaneous 1-axis control basis. (This mode of feed is the conventional type of manual handle feed.)



Feed along a specified axis

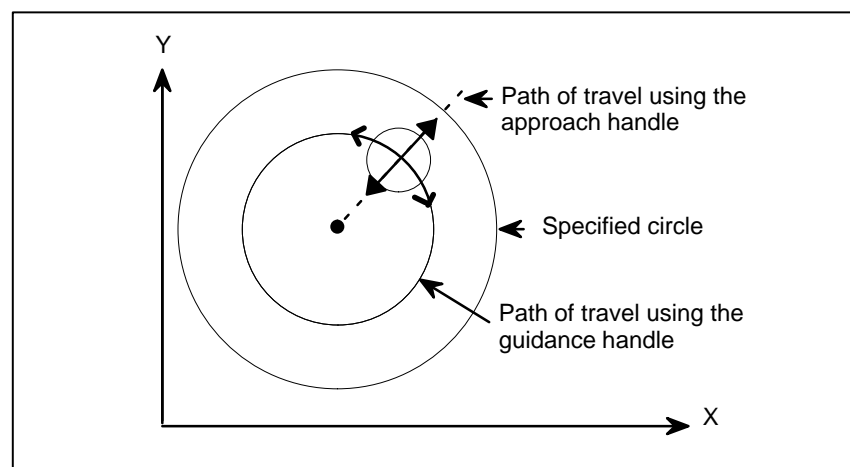
(2) Linear feed (simultaneous 2-axis control)

By turning a manual handle, the tool can be moved along the straight line parallel to a specified straight line on a simultaneous 2-axis control basis. This manual handle is referred to as the guidance handle. Moreover, by turning another manual handle, the tool can be moved at right angles to a specified straight line on a simultaneous 2-axis control basis. This manual handle is referred to as the approach handle. When the guidance handle or approach handle is turned clockwise or counterclockwise, the tool travels forward or backward along the respective path.

**Linear feed**

(3) Circular feed (simultaneous 2-axis control)

By turning a manual handle, the tool can be moved from the current position along the concentric circle that has the same center as a specified circle on a simultaneous 2-axis control basis. This manual handle is referred to as the guidance handle. Moreover, by turning another manual handle, the tool can be moved along the normal to a specified circle on a simultaneous 2-axis control basis. This manual handle is referred to as the approach handle. When the guidance handle or approach handle is turned clockwise or counterclockwise, the tool travels forward or backward along the respective path.

**Circular feed**

- **Feedrate for manual handle feed**

Feedrate

The feedrate depends on the speed at which a manual handle is turned. A distance to be traveled by the tool (along a tangent in the case of linear or circular feed) when a manual handle is turned by one pulse can be selected using the manual handle feed travel distance magnification switch.

- **Manual handle selection**

The Series 16/18 has three manual pulse generator interfaces to allow up to three manual handles to be connected. For information about how to use the manual handles connected to the interfaces (whether to use each manual handle as a handle for feed along an axis, as a guidance handle, or as an approach handle), refer to the relevant manual provided by the machine tool builder.

- **Direction of movement using manual handles**

The user can specify the direction of the tool moved along a straight line or circle (for example, whether to make a clockwise or counterclockwise movement along a circle) when the guidance handle or approach handle is turned clockwise or counterclockwise. For details, refer to the relevant manual provided by the machine tool builder.

- **Jog feed (JOG)**

In jog feed, the tool can be moved along a specified axis (X-axis, Y-axis, Z-axis, ..., or the 8th axis), or can be moved along a tilted straight line (linear feed) or a circle (circular feed).

(1) Feed along a specified axis (simultaneous 1-axis control)

While a feed axis and its direction are specified with the feed axis direction select switch, the tool moves in the specified axis direction at the feedrate specified in parameter No. 1423. The feedrate can be overridden using the manual feedrate override dial.

(2) Linear feed (simultaneous 2-axis control)

By defining a straight line beforehand, the tool can be moved as follows:

- While a feed axis and its direction are selected using the feed axis direction select switch, the tool moves along a straight line parallel to the specified straight line on a simultaneous 2-axis control basis.
- While a feed axis and its direction are selected using the feed axis direction select switch, the tool moves at right angles to the specified straight line on a simultaneous 2-axis control basis.

The feedrate in the tangential direction is specified in parameter No. 1410. The feedrate can be overridden using the manual feedrate override dial.

(3) Circular feed (simultaneous 2-axis control)

By defining a circle beforehand, the tool can be moved as follows:

- While a feed axis and its direction are selected using the feed axis γ direction select switch, the tool moves from the current position along the concentric circle that has the same center as the specified circle.
- While a feed axis and its direction are selected using the feed axis γ direction select switch, the tool moves along the normal to the specified circle.

The feedrate in the tangential direction is specified in parameter No. 1410. The feedrate can be overridden using the manual feedrate override dial.

- **Manual handle feed in JOG mode**

Even in JOG mode, manual handle feed can be enabled using bit 0 (JHD) of parameter No. 7100. In this case, however, manual handle feed is enabled only when the tool is not moved along any axis by jog feed.

Limitations

- **Mirror image**

Never use the mirror image function when performing manual operation. (Perform manual operation when the mirror image switch is off, and mirror image setting is off.)

3.8 MANUAL RIGID TAPPING

For execution of rigid tapping, set rigid mode, then switch to handle mode and move the tapping axis with a manual handle. For more information about rigid tapping, see Section II-14.2 and refer to the relevant manual provided by the machine tool builder.

Procedure for Manual Rigid Tapping

Procedure

1 Stop the spindle and servo axes, then set MDI mode by pressing the MDI switch among the mode selection switches.

2 Enter and execute the following program:

```
M29 S1000 ;
```

```
G91 G84 Z0 F1000 ;
```

The program above is required to determine a screw lead and set rigid tapping mode. In this program, a tapping axis must always be specified. Specify a value that does not operate the tapping axis.

WARNING

In this MDI programming, never specify commands to position the tool at a drilling position and at point R. Otherwise, the tool moves along an axis.

3 When the entered program is executed, rigid tapping mode is set.

4 After rigid mode is set upon completion of MDI program execution, switch to the handle mode by pressing the handle switch among the mode selection switches.

CAUTION

At this time, never press the reset key. Otherwise, rigid mode is canceled.

5 To perform rigid tapping, select a tapping axis with the handle feed axis select switch, and move the tapping axis with the manual handle.

Explanations

- **Manual rigid tapping** Manual rigid tapping is enabled by setting bit 0 (HRG) of parameter No. 5203 to 1.
- **Cancellation of rigid mode** To cancel rigid mode, specify G80 as same the normal rigid tapping. When the reset key is pressed, rigid mode is canceled, but the canned cycle is not canceled.

When the rigid mode switch is to be set to off for rigid mode cancellation (when bit 2 (CRG) of parameter No. 5200 is set to 0), the G80 command ends after the rigid mode switch is set to off.
- **Spindle rotation direction** The rotation direction of the spindle is determined by a specified tapping cycle G code and the setting of bit 1 (HRM) of parameter No. 5203. For example, when the HRM parameter is set to 0 in G84 mode, the spindle makes forward rotations as the tapping axis moves in the minus direction. (When the tapping axis moves in the plus direction, the spindle makes reverse rotations.)
- **Arbitrary tapping axis** By setting bit 0 (FXY) of parameter No. 5101 to 1, an arbitrary tapping axis can be selected. In this case, specify a G code for plane selection and tapping axis address when rigid mode is set in MDI mode.
- **Specification of M29 and G84 in the same block** In an MDI program for setting rigid mode, G84 can be used as a rigid tapping G code, or M29 and G84 can be specified in the same block.
- **Specification of manual handle feed faster than the rapid traverse rate** Set bit 0 (HPF) of parameter No. 7100 to 0 so that when manual handle feed is specified which is faster than the rapid traverse rate, the handle pulses beyond the rapid traverse rate are ignored.

Limitations

- **Excessive error check** In manual rigid tapping, only an excessive error during movement is checked.
- **Tool axis direction handle feed** Tool axis direction handle feed is disabled.
- **Extraction override** In manual rigid tapping, the extraction override function is disabled, and the use of an acceleration/deceleration time constant for extraction is disabled.
- **Number of repeats** In MDI programming, never specify K0 and L0, which are used to specify that the number of repeats is 0 and to disable the execution of a G84 block. If K0 or L0 is specified, rigid mode cannot be set.
- **Positioning of the tool to a drilling position** When positioning the tool to a drilling position, select the X-axis or Y-axis with the axis select switch in handle mode. Never use the method of positioning to a drilling position in MDI mode or MEM mode. The method can operate the tapping axis.

3.9 MANUAL NUMERIC COMMAND

The manual numeric command function allows data programmed through the MDI to be executed in jog mode. Whenever the system is ready for jog feed, a manual numeric command can be executed. The following eight functions are supported:

- (1) Positioning (G00)
- (2) Linear interpolation (G01)
- (3) Automatic reference position return (G28)
- (4) 2nd/3rd/4th reference position return (G30)
- (5) M codes (miscellaneous functions)
- (6) S codes (spindle functions)
- (7) T codes (tool functions)
- (8) B codes (second auxiliary functions)

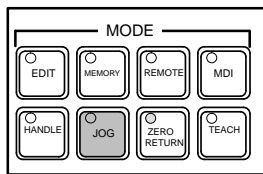
By setting the following parameters, the commands for axial motion and the M, S, T, and B functions can be disabled:

- (1) Positioning (G00):
- (2) Linear interpolation (G01):
- (3) Automatic reference position return (G28): . .
- (4) 2nd/3rd/4th reference position return (G30): .
- (5) M codes (miscellaneous functions):
 Bit 0 (JMF) of parameter No. 7002
- (6) S codes (spindle functions): Bit 1 (JSF) of parameter No. 7002
- (7) T codes (tool functions): Bit 2 (JSF) of parameter No. 7002
- (8) B codes (second auxiliary functions):
 Bit 3 (JBF) of parameter No. 7002

Bit 0 (JAXx) of parameter No. 7010

Procedure	Manual numeric command
-----------	------------------------

Procedure



- 1 Press the jog switch (one of the mode selection switches).
- 2 Press function key PROG.
- 3 Press soft key **[JOG]** on the screen. The following manual numeric command screen is displayed.

Example 1: When the maximum number of controlled axes is six

```

PROGRAM (JOG)                                O0010 N00020
G00 P          (ABSOLUTE)      (DISTANCE TO GO)
X              X      0.000    X      0.000
Y              Y      0.000    Y      0.000
Z              Z      0.000    Z      0.000
U              U      0.000    U      0.000
V              V      0.000    V      0.000
W              W      0.000    W      0.000
M
S
T
B
>_

JOG  ****  ***  ***                                00 : 00 : 00
( PRGRM ) ( JOG ) ( CURRNT ) ( NEXT ) ( OPRT )
```


Example 2: When the maximum number of controlled axes is 7 or 8

PROGRAM (JOG)		O0010 N00020	
G00 P	(ABSOLUTE)	(DISTANCE TO GO)	
X	X 0.000	X 0.000	
Y	Y 0.000	Y 0.000	
Z	Z 0.000	Z 0.000	
U	U 0.000	U 0.000	
V	V 0.000	V 0.000	
W	W 0.000	W 0.000	
A	A 0.000	A 0.000	
C	C 0.000	C 0.000	
M T			
S B			
>_			
JOG **** * * *		00 : 00 : 00	
(PRGRM)	(JOG)	(CURRNT)	(NEXT) (OPRT)

- 4 Enter the required commands by using address keys and numeric keys on the MDI panel, then press soft key **[INPUT]** or the key to set the entered data.

PROGRAM (JOG)		O0010 N00020	
G00 P	(ABSOLUTE)	(DISTANCE TO GO)	
X 10.000	X 0.000	X 0.000	
Y	Y 0.000	Y 0.000	
Z	Z 0.000	Z 0.000	
U	U 0.000	U 0.000	
V	V 0.000	V 0.000	
W	W 0.000	W 0.000	
M			
S			
T			
B			
>Z120.5_			
JOG **** * * *		00 : 00 : 00	
()	()	(CLEAR)	() (INPUT)

The following data can be set:

1. G00: Positioning
2. G01: Linear interpolation
3. G28: Automatic reference position return
4. G30: 2nd/3rd/4th reference position return
5. M codes: Miscellaneous functions
6. S codes: Spindle functions
7. T codes: Tool functions
8. B codes: Second auxiliary functions

The set data is maintained even when the screen or mode is changed.

NOTE

When an alarm state exists, data cannot be set.

- 5 Press the cycle start switch on the machine operator's panel to start command execution. The status is indicated as "MSTR." (When the 9" screen is being used, the actual feedrate "ACT.F" and spindle speed "SACT" appear on the key input line.) The automatic operation signal, STL, can be turned on by setting bit 2 (JST) of parameter No. 7001.

```

~
|
|  ACT.F 1000 SACT          0
|  JOG  MSTR *** MTN      00 : 00 : 00
|
~

```

NOTE

If the cycle start switch is pressed while an alarm state exists, a "START IMPOSSIBLE" warning is generated, and the entered data cannot be executed.

- 6 Upon the completion of execution, the "MSTR" status indication is cleared from the screen, and automatic operation signal STL is turned off. The set data is cleared entirely. G codes are set to G00 or G01 according to the setting of bit 0 (G01) of parameter No. 3402.

Explanations

• Positioning

An amount of travel is given as a numeric value, preceded by an address such as X, Y, or Z. This is always regarded as being an incremental command, regardless of whether G90 or G91 is specified.

The tool moves along each axis independently at the rapid traverse rate. Linear interpolation type positioning (where the tool path is linear) can also be performed by setting bit 1 (LRP) of parameter No. 1401.

	Manual rapid traverse selection switch	
	Off	On
Feedrate (parameter)	Jog feedrate for each axis (No. 1423)	Rapid traverse rate for each axis (No. 1420)
Automatic acceleration/ deceleration (parameter)	Exponential acceleration/ deceleration in jog feed for each axis (No. 1624)	Linear acceleration/ deceleration in rapid traverse for each axis (No. 1620)
Override	Manual feed override	Rapid traverse override

NOTE

When the manual rapid traverse selection switch is set to the OFF position, the jog feedrate for each axis is clamped such that a parameter-set feedrate, determined by bit 1 (LRP) of parameter No. 1401 as shown below, is not exceeded.

LRP = 0: Manual rapid traverse rate for each axis
(parameter No. 1424)

LRP = 1: Rapid traverse rate for each axis
(parameter No. 1420)

- **Linear interpolation (G01)**

An amount of travel is given as a numeric value, preceded by an address such as X, Y, or Z. This is always regarded as being an incremental command, regardless of whether G90 or G91 is specified. Axial movements are always performed in incremental mode even during scaling or polar coordinate interpolation. In addition, movement is always performed in feed per minute mode regardless of the specification of G94 or G95.

Feedrate (parameter)	Dry run feedrate (No. 1410)
Automatic acceleration/deceleration (parameter)	Exponential acceleration/deceleration in cutting feed for each axis (No. 1622)
Override	Manual feed override

NOTE

Since the feedrate is always set to the dry run feedrate, regardless of the setting of the dry run switch, the feedrate cannot be specified using F. The feedrate is clamped such that the maximum cutting feedrate, set in parameter No. 1422, is not exceeded.

- **Automatic reference position return (G28)**

The tool returns directly to the reference position without passing through any intermediate points, regardless of the specified amount of travel. For axes for which no move command is specified, however, a return operation is not performed.

Feedrate (parameter)	Rapid traverse rate (No. 1420)
Automatic acceleration/deceleration (parameter)	Linear acceleration/deceleration in rapid traverse for each axis (No. 1620)
Override	Rapid traverse override

- **2nd, 3rd, or 4th reference position return (G30)**

The tool returns directly to the 2nd, 3rd, or 4th reference position without passing through any intermediate points, regardless of the specified amount of travel. To select a reference position, specify P2, P3, or P4 in address P. If address P is omitted, a return to the second reference position is performed.

Feedrate (parameter)	Rapid traverse rate for each axis (No. 1420)
Automatic acceleration/deceleration (parameter)	Linear acceleration/deceleration in rapid traverse for each axis (No. 1620)
Override	Rapid traverse override

NOTE

The function for 3rd/4th reference position return is optional.

- When the option is not selected

Return to the 2nd reference position is performed, regardless of the specification of address P.

- When the option is selected

If neither P2, P3, nor P4 is specified in address P, a "START IMPOSSIBLE" warning is generated, and the entered data cannot be executed.

- **M codes (miscellaneous functions)**

After address M, specify a numeric value of no more than the number of digits specified by parameter No. 3030. When M98 or M99 is specified, it is executed but not output to the PMC.

NOTE

Neither subprogram calls nor custom macro calls can be performed using M codes.

- **S codes (spindle functions)**

After address S, specify a numeric value of no more than the number of digits specified by parameter No. 3031.

NOTE

Subprogram calls cannot be performed using S codes.

- **T codes (tool functions)**

After address T, specify a numeric value of no more than the number of digits specified by parameter No. 3032.

NOTE

Subprogram calls cannot be performed using T codes.

- **B codes (second auxiliary functions)**


After address B, specify a numeric value of no more than the number of digits specified by parameter No. 3033.

NOTE


- 1 B codes can be renamed "U," "V," "W," "A," or "C" by setting parameter No. 3460. If the new name is the same as an axis name address, "B" is used. When "B" is used, and axis name "B" exists, "B" is used as the axis address. In this case, no second auxiliary function can be specified.
- 2 Subprogram calls cannot be performed using B codes.

- **Data input**

- (1) When addresses and numeric values of a command are typed, then soft key **[INPUT]** is pressed, the entered data is set. In this case, the input unit is either the least input increment or calculator-type input format, according to the setting of bit 0 (DPI) of parameter No. 3401.

The  key on the MDI panel can be used instead of soft key **[INPUT]**.

- (2) Commands can be typed successively.
- (3) Key entry is disabled during execution.


If soft key **[INPUT]** or the  key on the MDI panel is pressed during execution, an "EXECUTION/MODE SWITCHING IN PROGRESS" warning is output.

- (4) If input data contains an error, the following warnings may appear:

Warning	Description
FORMAT ERROR	<ul style="list-style-type: none"> · A G code other than G00, G01, and G28 has been entered. · An address other than those displayed on the manual numeric command screen has been entered.
TOO MANY DIGITS	<p>A value that exceeds the following limitations has been entered.</p> <ul style="list-style-type: none"> · Address G: 2 digits · Address P: 1 digit · Axis address: 8 digits · M, S, T, B: The parameter-set number of digits

NOTE

Even when the memory protection key is set, key input can nevertheless be performed.

- **Erasing data**
 - (1) When soft key **[CLEAR]** is pressed, followed by soft key **[EXEC]**, all the set data is cleared. In this case, however, the G codes are set to G00 or G01, depending on the setting of bit 0 (G01) of parameter No. 3402.
Data can also be cleared by pressing the  key on the MDI panel.
 - (2) If soft key **[CLEAR]** is pressed during execution, an "EXECUTION/MODE SWITCHING IN PROGRESS" warning is output.

- **Halting execution**

If one of the following occurs during execution, execution is halted, and the data is cleared in the same way as when soft key **[CLEAR]** is pressed. The remaining distance to be traveled is canceled.

 - (1) When a feed hold is applied
 - (2) When the mode is changed to other than jog feed mode
 - (3) When an alarm is generated
 - (4) When a reset or emergency stop is applied

The M, S, T, and B functions remain effective even upon the occurrence of the above events, with the exception of (4).

- **Modal information**

Modal G codes and addresses used in automatic operation or MDI operation are not affected by the execution of commands specified using the manual numeric command function.

- **Jog feed**

When the tool is moved along an axis using a feed axis and direction selection switch on the manual numeric command screen, the remaining amount of travel is always shown as "0".

Limitations

- **Constant surface speed control**

S codes cannot be specified in constant surface speed control mode.
- **M, S, T, and B functions**

While automatic operation is halted, manual numeric commands can be executed. In the following cases, however, a "START IMPOSSIBLE" warning is output, and command execution is disabled.

 - (1) When an M, S, T, or B function is already being executed, a manual numeric command containing an M, S, T, or B function cannot be executed.
 - (2) When an M, S, T, or B function is already being executed, and that function alone is specified or a block specifying that function also contains another function (such as a move command or dwell function) which has already been completed, a manual numeric command cannot be executed.
- **Jog feed**

When a manual numeric command is specified while the tool is being moved along an axis by using a feed axis and direction selection switch, the axial movement is interrupted, and the manual numeric command is executed. Therefore, the tool cannot be moved along an axis by using a feed axis and direction selection switch during execution of a manual numeric command.
- **Mirror image**

A mirror image cannot be produced for the direction of a specified axial movement.

- **REF mode**

The manual numeric command screen appears even when the mode is changed to REF mode. If, however, an attempt is made to set and execute data, a "WRONG MODE" warning is output and the attempt fails.

- **Indexing of the index table and chopping**

Commands cannot be specified for an axis along which operation is being performed during indexing or chopping.

If such an axis is specified for execution, a "START IMPOSSIBLE" warning is output.

4

AUTOMATIC OPERATION

Programmed operation of a CNC machine tool is referred to as automatic operation.


This chapter explains the following types of automatic operation:

- **MEMORY OPERATION**
Operation by executing a program registered in CNC memory
- **MDI OPERATION**
Operation by executing a program entered from the MDI panel
- **DNC operation**
Operation while reading a program from an input/output device
- **SIMULTANEOUS INPUT/OUTPUT**
Program execution and memory registration can be performed simultaneously.
- **PROGRAM RESTART**
Restarting a program for automatic operation from an intermediate point
- **SCHEDULING FUNCTION**
Scheduled operation by executing programs (files) registered in an external input/output device (Handy File, Floppy Cassette, or FA Card)
- **SUBPROGRAM CALL FUNCTION**
Function for calling and executing subprograms (files) registered in an external input/output device (Handy File, Floppy Cassette, or FA Card) during memory operation
- **MANUAL HANDLE INTERRUPTION**
Function for performing manual feed during movement executed by automatic operation
- **MIRROR IMAGE**
Function for enabling mirror-image movement along an axis during automatic operation
- **TOOL WITHDRAWAL AND RETURN**
Function for withdrawing the tool from a workpiece and for returning the tool to restart machining
- **RETRACE FUNCTION**
Function for moving the tool in the reverse direction to retrace the path followed, and for moving the tool in the forward direction again along the retraced path.
- **MANUAL INTERVENTION AND RETURN**
Function restarting automatic operation by returning the tool to the position where manual intervention was started during automatic operation
- **Retreat and retry functions**
This function enables machining to be restarted from the start block.

4.1 MEMORY OPERATION

Programs are registered in memory in advance. When one of these programs is selected and the cycle start switch on the machine operator's panel is pressed, automatic operation starts, and the cycle start LED goes on.

When the feed hold switch on the machine operator's panel is pressed during automatic operation, automatic operation is stopped temporarily. When the cycle start switch is pressed again, automatic operation is restarted.



When the  key on the MDI panel is pressed, automatic operation terminates and the reset state is entered.

For the two-path control, the programs for the two tool posts can be executed simultaneously so the two tool posts can operate independently at the same time.

The following procedure is given as an example. For actual operation, refer to the manual supplied by the machine tool builder.

Procedure for Memory Operation

Procedure


- 1 Press the **MEMORY** mode selection switch.
- 2 Select a program from the registered programs. To do this, follow the steps below.
 - 2-1 Press  to display the program screen.
 - 2-2 Press address .
 - 2-3 Enter a program number using the numeric keys.
 - 2-4 Press the **[O SRH]** soft key.
- 3 For the two-path control, select the tool post to be operated with the tool post selection switch on the machine operator's panel.
- 4 Press the cycle start switch on the machine operator's panel. Automatic operation starts, and the cycle start LED goes on. When automatic operation terminates, the cycle start LED goes off.
- 5 To stop or cancel memory operation midway through, follow the steps below.
 - a. Stopping memory operation

Press the feed hold switch on the machine operator's panel. The feed hold LED goes on and the cycle start LED goes off. The machine responds as follows:

 - (i) When the machine was moving, feed operation decelerates and stops.
 - (ii) When dwell was being performed, dwell is stopped.
 - (iii) When M, S, or T was being executed, the operation is stopped after M, S, or T is finished.

When the cycle start switch on the machine operator's panel is pressed while the feed hold LED is on, machine operation restarts.

b. Terminating memory operation

Press the  key on the MDI panel.

Automatic operation is terminated and the reset state is entered. When a reset is applied during movement, movement decelerates then stops.

Explanation**Memory operation**

After memory operation is started, the following are executed:

- (1) A one-block command is read from the specified program.
- (2) The block command is decoded.
- (3) The command execution is started.
- (4) The command in the next block is read.
- (5) Buffering is executed. That is, the command is decoded to allow immediate execution.
- (6) Immediately after the preceding block is executed, execution of the next block can be started. This is because buffering has been executed.
- (7) Hereafter, memory operation can be executed by repeating the steps (4) to (6).

Stopping and terminating memory operation

Memory operation can be stopped using one of two methods: Specify a stop command, or press a key on the machine operator's panel.

- The stop commands include M00 (program stop), M01 (optional stop), and M02 and M30 (program end).
- There are two keys to stop memory operation: The feed hold key and reset key.

• Program stop (M00)

Memory operation is stopped after a block containing M00 is executed. When the program is stopped, all existing modal information remains unchanged as in single block operation. The memory operation can be restarted by pressing the cycle start button. Operation may vary depending on the machine tool builder. Refer to the manual supplied by the machine tool builder.

• Optional stop (M01)

Similarly to M00, memory operation is stopped after a block containing M01 is executed. This code is only effective when the Optional Stop switch on the machine operator's panel is set to ON. Operation may vary depending on the machine tool builder. Refer to the manual supplied by the machine tool builder.

• Program end (M02, M30)


When M02 or M30 (specified at the end of the main program) is read, memory operation is terminated and the reset state is entered.

In some machines, M30 returns control to the top of the program. For details, refer to the manual supplied by the machine tool builder.

• Feed hold

When Feed Hold button on the operator's panel is pressed during memory operation, the tool decelerates to a stop at a time.

• Reset

Automatic operation can be stopped and the system can be made to the reset state by using  key on the MDI panel or external reset signal.

When reset operation is applied to the system during a tool moving status, the motion is slowed down then stops.

- **Optional block skip**

When the optional block skip switch on the machine operator's panel is turned on, blocks containing a slash (/) are ignored.

- **Cycle start for the two-path control**

For the two-path control, a cycle start switch is provided for each tool post. This allows the operator to activate a single tool posts to operate them at the same time in memory operation or MDI operation. In general, select the tool post to be operated with the tool post selection switch on the machine operator's panel and then press the cycle start button to activate the selected tool post. (The procedure may vary with the machine tool builder. Refer to the appropriate manual issued by the machine tool builder.)

- Calling a subprogram stored in an external input/output device**


A file (subprogram) in an external input/output device such as a Floppy Cassette can be called and executed during memory operation. For details, see Section 4.7.

4.2 MDI OPERATION

In the **MDI** mode, a program consisting of up to 10 lines can be created in the same format as normal programs and executed from the MDI panel. MDI operation is used for simple test operations. The following procedure is given as an example. For actual operation, refer to the manual supplied by the machine tool builder.

Procedure for MDI Operation

Procedure

- 1 Press the **MDI** mode selection switch.
For the two-path control, select the tool post for which a program is to be created with the tool post selection switch. Create a separate program for each tool post.
- 2 Press the  function key on the MDI panel to select the program screen. The following screen appears:

```

PROGRAM ( MDI )                                0010  00002




O0000;

G00 G90 G94 G40 G80 G50 G54 G69
G17 G22 G21 G49 G98 G67 G64 G15
   B  HM
   T   D
   F   S

>_
MDI ***** 20 : 40 : 05
{ PRGRM } { MDI } { CURRNT } { NEXT } { (OPRT) }

```

Program number O0000 is entered automatically.

- 3 Prepare a program to be executed by an operation similar to normal program editing. M99 specified in the last block can return control to the beginning of the program after operation ends. Word insertion, modification, deletion, word search, address search, and program search are available for programs created in the MDI mode. For program editing, see III-9.
- 4 To entirely erase a program created in MDI mode, use one of the following methods:
 - a. Enter address , then press the  key on the MDI panel.
 - b. Alternatively, press the  key. In this case, set bit 7 of parameter MCL No. 3203 to 1 in advance.

- 5** To execute a program, set the cursor on the head of the program. (Start from an intermediate point is possible.) Push Cycle Start button on the operator's panel. By this action, the prepared program will start. (For the two-path control, select the tool post to be operated with the tool post selection switch on the machine operator's panel beforehand.) When the program end (M02, M30) or ER(%) is executed, the prepared program will be automatically erased and the operation will end.
By command of M99, control returns to the head of the prepared program.

```

PROGRAM ( MDI )                                O0001 N00003
O0000 G00 X100.0 Y200. ;
M03 ;
G01 Z120.0 F500 ;
M93 P9010 ;
G00 Z0.0 ;
%

G00 G90 G94 G40 G80 G50 G54 G69
G17 G22 G21 G49 G98 G67 G64 G15
  B  HM
  T    D
  F    S
>_
MDI  ****  ***  ***                12 : 42 : 39
{ PRGRM } { MDI } { CURRNT } { NEXT } { (OPRT) }

```

- 6** To stop or terminate MDI operation in midway through, follow the steps below.


a. Stopping MDI operation

Press the feed hold switch on the machine operator's panel. The feed hold LED goes on and the cycle start LED goes off. The machine responds as follows:

- (i) When the machine was moving, feed operation decelerates and stops.
- (ii) When dwell was being performed, dwell is stopped.
- (iii) When M, S, or T was being executed, the operation is stopped after M, S, or T is finished.

When the cycle start switch on the machine operator's panel is pressed, machine operation restarts.

b. Terminating MDI operation

Press the  key on the MDI panel.

Automatic operation is terminated and the reset state is entered. When a reset is applied during movement, movement decelerates then stops.

Explanation

The previous explanation of how to execute and stop memory operation also applies to MDI operation, except that in MDI operation, M30 does not return control to the beginning of the program (M99 performs this function).

• Erasing the program

Programs prepared in the **MDI** mode will be erased in the following cases:

- In MDI operation, if M02, M30 or ER(%) is executed.
(If bit 6 (MER) of parameter No. 3203 is set to 1, however, the program is erased when execution of the last block of the program is completed by single-block operation.)
- In **MEMORY** mode, if memory operation is performed.
- In **EDIT** mode, if any editing is performed.
- Background editing is performed.
- Upon reset when bit 7 (MCL) of parameter No. 3203 is set to 1

• Restart

After the editing operation during the stop of MDI operation was done, operation starts from the current cursor position.

• Editing a program during MDI operation

A program can be edited during MDI operation. The editing of a program, however, is disabled until the CNC is reset, when bit 5 (MIE) of parameter No. 3203 is set accordingly.

Limitations

• Program registration

Programs created in MDI mode cannot be registered.

• Number of lines in a program

A program can have as many lines as can fit on one page of the screen. A program consisting of up to six lines can be created. When parameter MDL (No. 3107 #7) is set to 0 to specify a mode that suppresses the display of continuous-state information, a program of up to 10 lines can be created.

If the created program exceeds the specified number of lines, % (ER) is deleted (prevents insertion and modification).

• Subprogram nesting

Calls to subprograms (M98) can be specified in a program created in the MDI mode. This means that a program registered in memory can be called and executed during MDI operation. In addition to the main program executed by automatic operation, up to two levels of subprogram nesting are allowed (when the custom macro option is provided, up to four levels are allowed).

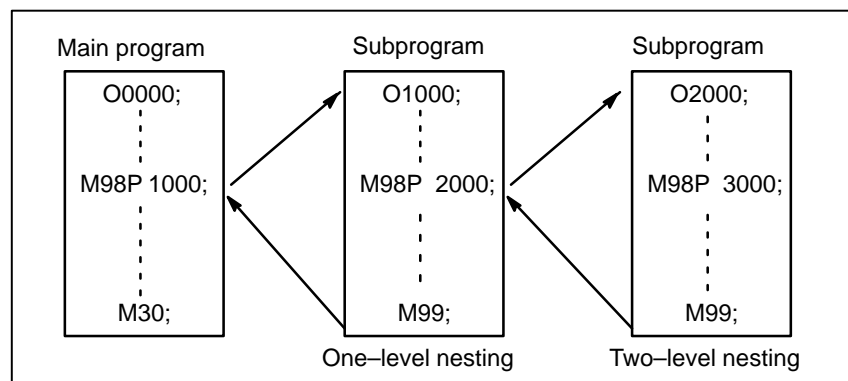


Fig. 4.2 (a) Nesting Level of Subprograms Called from the MDI Program

- **Macro call**

When the custom macro option is provided, macro programs can also be created, called, and executed in the **MDI** mode. However, macro call commands cannot be executed when the mode is changed to **MDI** mode after memory operation is stopped during execution of a subprogram.
- **Memory area**

When a program is created in the **MDI** mode, an empty area in program memory is used. If program memory is full, no programs can be created in the **MDI** mode.

4.3 DNC OPERATION

By activating automatic operation during the DNC operation mode (RMT), it is possible to perform machining (DNC operation) while a program is being read in via reader/puncher interface, or remote buffer. If the floppy cassette directory display option is available, it is possible to select files (programs) saved in an external input/output unit of a floppy format (Handy File, Floppy Cassettes, or FA card) and specify (schedule) the sequence and frequency of execution for automatic operation.

(see III-4.4)

To use the DNC operation function, it is necessary to set the parameters related to the reader/punch interface, and remote buffer in advance.

DNC OPERATION

Procedure

- 1 Search for the program (file) to be executed.
- 2 Press the REMOTE switch on the machine operator's panel to set RMT mode, then press the cycle start switch. The selected file is executed. For details of the use of the REMOTE switch, refer to the relevant manual supplied by the machine tool builder.

- Program check screen
(7.2"/8.4"LCD)

```

PROGRAM CHECK                                O0001 N00020
N020 X100.0 Z100.0 (DNC-PROG) ;
N030 X200.0 Z200.0 ;
N050 X400.0 Z400.0 ;

(RELATIVE) (DIST TO GO) G00 G17 G90
X 100.000 X 0.000 G22 G94 G21
Y 100.000 Y 0.000 G41 G49 G80
Z 0.000 Z 0.000 G98 G50 G67
A 0.000 A 0.000 B
C 0.000 C 0.000 H M
HD.T NX.T D M
F S M
ACT.F SACT REPEAT
RMT STRT MTN *** ** 21:20:05
[ ABS ] [ REL ] [ ] [ ] [ (OPRT) ]

```


Limitations

- **Limit on number of characters**
In program display, no more than 256 characters can be displayed. Accordingly, character display may be truncated in the middle of a block.
- **M198 (command for calling a program from within an external input/output unit)**
In DNC operation, M198 cannot be executed. If M198 is executed, P/S alarm No. 210 is issued.
- **Custom macro**
In DNC operation, custom macros can be specified, but no repeat instruction and branch instruction can be programmed. If a repeat instruction or branch instruction is executed, P/S alarm No. 123 is issued. When reserved words (such as IF, WHILE, COS, and NE) used with custom macros in DNC operation are displayed during program display, a blank is inserted between adjacent characters.
Example

		[During DNC operation]
#102=SIN[#100] ;	→	#102 = S I N[#100] ;
IF[#100NE0]GOTO5 ;	→	I F[#100NE0] G O T O 5 ;
- **M99**
When control is returned from a subprogram or macro program to the calling program during DNC operation, it becomes impossible to use a return command (M99P****) for which a sequence number is specified.

Alarm

Number	Message	Contents
086	DR SIGNAL OFF	When entering data in the memory by using Reader / Puncher interface, the ready signal (DR) of reader / puncher was turned off. Power supply of I/O unit is off or cable is not connected or a P.C.B. is defective.
123	CAN NOT USE MACRO COMMAND IN DNC	Macro control command is used during DNC operation. Modify the program.
210	CAN NOT COMAND M198/M199	Or M198 is executed in the DNC operation. Modify the program.

4.4 SIMULTANEOUS INPUT/OUTPUT

While an automation operation is being performed, a program input from an I/O device connected to the reader/punch interface can be executed and output through the reader/punch interface at the same time.

Simultaneous Input/Output

Procedure

- **Basic simultaneous input procedure**

- 1 Search for the program (file) to be output and executed.
- 2 Press the REMOTE switch on the machine operator's panel to set RMT mode. For details of the use of the REMOTE switch, refer to the relevant manual supplied by the machine tool builder.
- 3 Set the simultaneous output operation mode select signal to 1.
- 4 Press the cycle start switch.
- 5 Program output and execution is performed on a block-by-block basis.

Program check screen

```

PROGRAM CHECK                                F0001 N00100
N100 X100. Y100. ;
N200 G01 X50. Y50. ;
N300 G00 X0 Y0 ;

(RELATIVE) (DIST TO GO) G00 G17 G90
X 100.000 X 0.000 G22 G94 G21
Y 100.000 Y 0.000 G40 G49 G80
Z 0.000 Z 0.000 G98 G50 G67
A 0.000 A 0.000 B
C 0.000 C 0.000 H M
HD.T NX.T D M
F S M
ACT.F SACT REPEAT
RMT STRT MTN *** *** 21:20:05
[ ABS ] [ REL ] [ ] [ ] [ (OPRT) ]
    
```

When a program is displayed, three blocks are displayed: the block currently being executed and the next two to be executed. When the single block function is selected, only the block currently being executed is displayed.

Any comment enclosed between a control-out mark (()) and control-in mark (()) within a block is not displayed.

- **Basic simultaneous output procedure**

- 1 Search for the program (file) to be output and executed.
- 2 Press the REMOTE switch on the machine operator's panel to set RMT mode. For details of the use of the REMOTE switch, refer to the relevant manual supplied by the machine tool builder.
- 3 Set the simultaneous output operation mode select signal to 1.
- 4 Press the cycle start switch.
- 5 Program output and execution is performed on a block-by-block basis.

Limitations

- **M198 (command for calling a program from within an external input/output unit)** M198 cannot be executed in the input, output and run simultaneous mode. An attempt to do so results in alarm No. 210.
- **Macro control command** A macro control command cannot be executed in the input, output and run simultaneous mode. An attempt to do so results in P/S alarm No. 123.
- **Alarm** If an alarm condition occurs during the input, output and run simultaneous mode, a block being processed when the alarm condition occurs and all blocks before that are input or output.
- **File name** In the output and run simultaneous mode, if a device used is a floppy disk drive or FA card, the file name is the execution program number.
- **Sub program call** When a program is being executed in the output and run simultaneous mode, if a subprogram is called, only the main program is output.

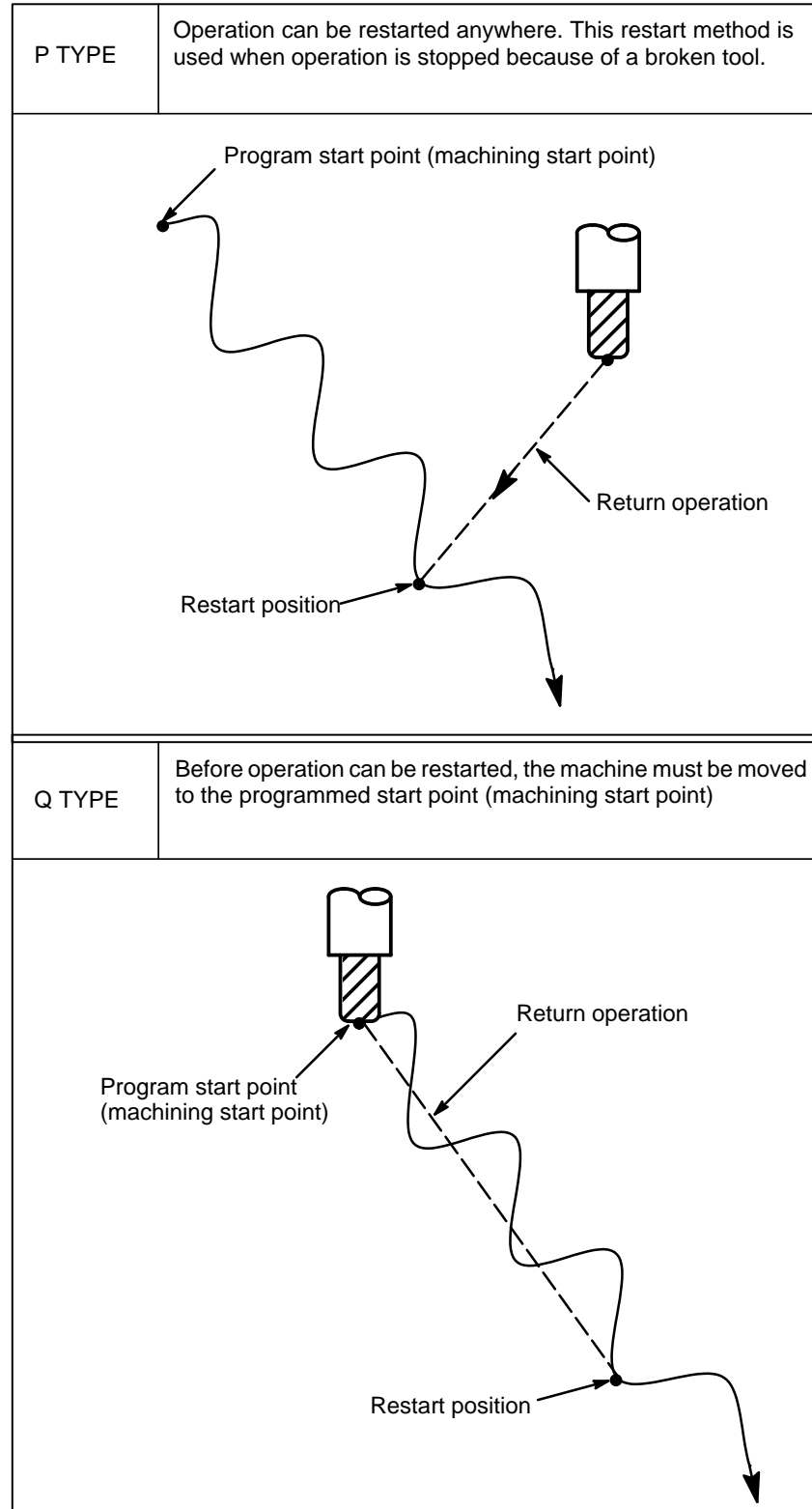
Alarm

Number	Message	Contents
123	CAN NOT USE MACRO COMMAND IN DNC	Macro control command is used during DNC operation. Modify the program.
210	CAN NOT COMMAND M198/M199	M198 or M199 is executed in the DNC operation. M198 is executed in the DNC operation. Modify the program.
222	DNC OP. NOT ALLOWED IN BG.-EDIT	Input and output are executed at a time in the background edition. Execute a correct operation.

4.5 PROGRAM RESTART

This function specifies Sequence No. of a block to be restarted when a tool is broken down or when it is desired to restart machining operation after a day off, and restarts the machining operation from that block. It can also be used as a high-speed program check function.

There are two restart methods: the P-type method and Q-type method.



Procedure for Program Restart by Specifying a Sequence Number

Procedure 1


[P TYPE]

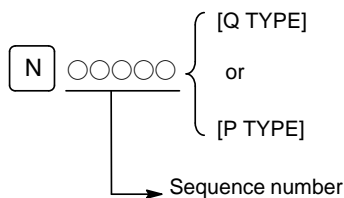
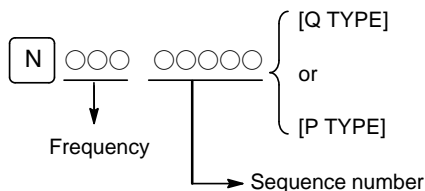
- 1 Retract the tool and replace it with a new one. When necessary, change the offset. (Go to step 2.)

[Q TYPE]

- 1 When power is turned ON or emergency stop is released, perform all necessary operations at that time, including the reference position return.
- 2 Move the machine manually to the program starting point (machining start point), and keep the modal data and coordinate system in the same conditions as at the machining start.
- 3 If necessary, modify the offset amount.

Procedure 2[COMMON TO P TYPE /
Q TYPE]

- 1 Turn the program restart switch on the machine operator's panel ON.
- 2 Press  key to display the desired program.
- 3 Find the program head.
- 4 Enter the sequence number of the block to be restarted, then press th **[P TYPE]** or **[Q TYPE]** soft key.



If the same sequence number appears more than once, the location of the target block must be specified. Specify a frequency and a sequence number.

- 5 The sequence number is searched for, and the program restart screen appears on the CRT display.

```

PROGRAM RESTART                                O0002 N01000

DESTINATION      M      1      2
X 57.096         1      2
Y 56.877         1      2
Z 56.943         1      2
                 1      2
                 1 *****
DISTANCE TO GO   ***** *****
1 X 1.459        T ***** *****
2 Y 10.309       S *****
3 Z 7.320

S 0 T0000

MEM ***** 10:10:40
[ RSTR ] [    ] [ FL.SDL ] [    ] [ (OPRT) ]

```

DESTINATION shows the position at which machining is to restart. DISTANCE TO GO shows the distance from the current tool position to the position where machining is to restart. A number to the left of each axis name indicates the order of axes (determined by parameter setting) along which the tool moves to the restart position.

The coordinates and amount of travel for restarting the program can be displayed for up to five axes. If your system supports six or more axes, pressing the **[RSTR]** soft key again displays the data for the sixth and subsequent axes. (The program restart screen displays only the data for CNC-controlled axes.)

M: Fourteen most recently specified M codes

T: Two most recently specified T codes

S: Most recently specified S code

B: Most recently specified B code

Codes are displayed in the order in which they are specified. All codes are cleared by a program restart command or cycle start in the reset state.

- 6 Turn the program re-start switch OFF. At this time, the figure at the left side of axis name DISTANCE TO GO blinks.
- 7 Check the screen for the M, S, T, and B codes to be executed. If they are found, enter the **MDI** mode, then execute the M, S, T, and B functions. After execution, restore the previous mode. These codes are not displayed on the program restart screen.
- 8 Check that the distance indicated under DISTANCE TO GO is correct. Also check whether there is the possibility that the tool might hit a workpiece or other objects when it moves to the machining restart position. If such a possibility exists, move the tool manually to a position from which the tool can move to the machining restart position without encountering any obstacles.
- 9 Press the cycle start button. The tool moves to the machining restart position at the dry run feedrate sequentially along axes in the order specified by parameter settings (No. 7310). Machining is then restarted.

Procedure for Program Restart by Specifying a Block Number

Procedure 1

[P TYPE]



- 1 Retract the tool and replace it with a new one. When necessary, change the offset. (Go to step 2.)

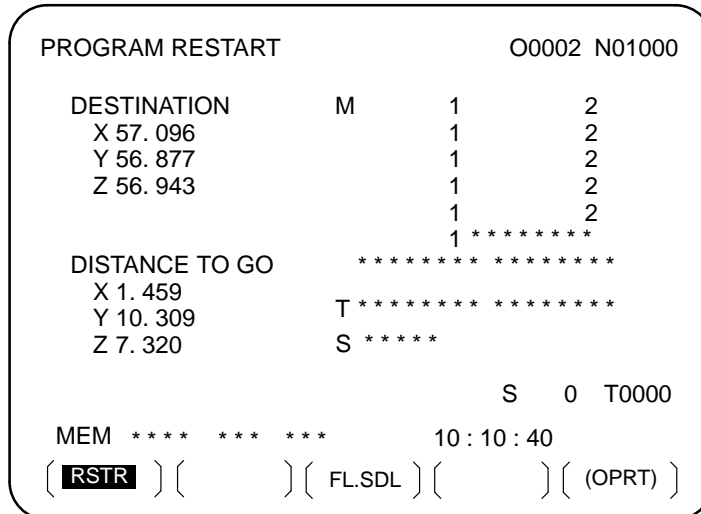
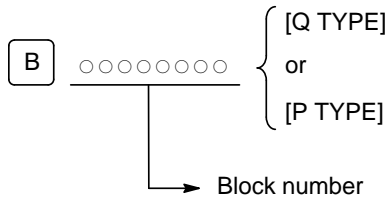
[Q TYPE]

- 1 When power is turned ON or emergency stop is released, perform all necessary operations at that time, including the reference position return.
- 2 Move the machine manually to the program starting point (machining start point), and keep the modal data and coordinate system in the same conditions as at the machining start.
- 3 If necessary, modify the offset amount.

Procedure 2

[COMMON TO P TYPE /
Q TYPE]

- 1 Turn the program restart switch on the machine operator's panel ON.
- 2 Press  key to display the desired program.
- 3 Find the program head. Press function  key.
- 4 Enter the number of the block to be restarted then press the **[P TYPE]** or **[Q TYPE]** soft key. The block number cannot exceed eight digits.
- 5 The block number is searched for, and the program restart screen appears on the CRT display.



DESTINATION shows the position at which machining is to restart. DISTANCE TO GO shows the distance from the current tool position to the position where machining is to restart. A number to the left of each axis name indicates the order of axes (determined by parameter setting) along which the tool moves to the restart position.

The coordinates and amount of travel for restarting the program can be displayed for up to five axes. If your system supports six or more axes, pressing the **[RSTR]** soft key again displays the data for the sixth and subsequent axes. (The program restart screen displays only the data for CNC-controlled axes.)

M: Fourteen most recently specified M codes

T: Two most recently specified T codes

S: Most recently specified S code

B: Most recently specified B code

Codes are displayed in the order in which they are specified. All codes are cleared by a program restart command or cycle start in the reset state.

- 6 Turn the program re-start switch OFF. At this time, the figure at the left side of axis name DISTANCE TO GO blinks.
- 7 Check the screen for the M, S, T, and B codes to be executed. If they are found, enter the **MDI** mode, then execute the M, S, T, and B functions. After execution, restore the previous mode. These codes are not displayed on the program restart screen.
- 8 Check that the distance indicated under DISTANCE TO GO is correct. Also check whether there is the possibility that the tool might hit a workpiece or other objects when it moves to the machining restart position. If such a possibility exists, move the tool manually to a position from which the tool can move to the machining restart position without encountering any obstacles.
- 9 Press the cycle start button. The tool moves to the machining restart position at the dry run feedrate sequentially along axes in the order specified by parameter settings (No. 7310). Machining is then restarted.

Explanations

- **Block number**

When the CNC is stopped, the number of executed blocks is displayed on the program screen or program restart screen. The operator can specify the number of the block from which the program is to be restarted, by referencing the number displayed on the CRT. The displayed number indicates the number of the block that was executed most recently. For example, to restart the program from the block at which execution stopped, specify the displayed number, plus one.

The number of blocks is counted from the start of machining, assuming one NC line of a CNC program to be one block.

< Example 1 >

CNC Program	Number of blocks
O 0001 ;	1
G90 G92 X0 Y0 Z0 ;	2
G01 X100. F100 ;	3
G03 X01 -50. F50 ;	4
M30 ;	5

< Example 2 >

CNC Program	Number of blocks
O 0001 ;	1
G90 G92 X0 Y0 Z0 ;	2
G90 G00 Z100. ;	3
G81 X100. Y0. Z-120. R-80. F50. ;	4
#1 = #1 + 1 ;	4
#2 = #2 + 1 ;	4
#3 = #3 + 1 ;	4
G00 X0 Z0 ;	5
M30 ;	6

Macro statements are not counted as blocks.

- **Storing / clearing the block number**

The block number is held in memory while no power is supplied. The number can be cleared by cycle start in the reset state.

- **Block number when a program is halted or stopped**

The program screen usually displays the number of the block currently being executed. When the execution of a block is completed, the CNC is reset, or the program is executed in single-block stop mode, the program screen displays the number of the program that was executed most recently.

When a CNC program is halted or stopped by feed hold, reset, or single-block stop, the following block numbers are displayed:

Feed hold : Block being executed

Reset : Block executed most recently

Single-block stop : Block executed most recently

For example, when the CNC is reset during the execution of block 10, the displayed block number changes from 10 to 9.

- **MDI intervention**

When MDI intervention is performed while the program is stopped by single-block stop, the CNC commands used for intervention are not counted as a block.

- **Block number exceeding eight digits**

When the block number displayed on the program screen exceeds eight digits, the block number is reset to 0 and counting continues.

Limitations

- **P-type restart**

Under any of the following conditions, P-type restart cannot be performed:

- When automatic operation has not been performed since the power was turned on
- When automatic operation has not been performed since an emergency stop was released
- When automatic operation has not been performed since the coordinate system was changed or shifted (change in an external offset from the workpiece reference point)

- **Restart block**

The block to be restarted need not be the block which was interrupted; operation can restart with any block. When P-type restart is performed, the restart block must use the same coordinate system as when operation was interrupted.

- **Single block** When single block operation is ON during movement to the restart position, operation stops every time the tool completes movement along an axis. When operation is stopped in the single block mode, MDI intervention cannot be performed.
- **Manual intervention** During movement to the restart position, manual intervention can be used to perform a return operation for an axis if it has not yet been performed for the axis. A return operation cannot be done further on axes for which a return has already been completed.
- **Reset** Never reset during the time from the start of a search at restart until machining is restarted. Otherwise, restart must be performed again from the first step.
- **Manual absolute** Regardless of whether machining has started or not, manual operation must be performed when the manual absolute mode is on.
- **Reference position return** If no absolute-position detector (absolute pulse coder) is provided, be sure to perform reference position return after turning on the power and before performing restart.

Alarm

Alarm No.	Contents
071	The specified block number for restarting the program is not found.
094	After interruption, a coordinate system was set, then P-type restart was specified.
095	After interruption, the coordinate system shift was changed, then P-type restart was specified.
096	After interruption, the coordinate system was changed, then P-type restart was specified.
097	When automatic operation has not been performed since the power was turned on, emergency stop was released, or P/S alarm 094 to 097 was reset, P-type restart was specified.
098	After the power was turned on, restart operation was performed without reference position return, but a G28 command was found in the program.
099	A move command was specified from the MDI panel during a restart operation.
5020	An erroneous parameter was specified for restarting a program.

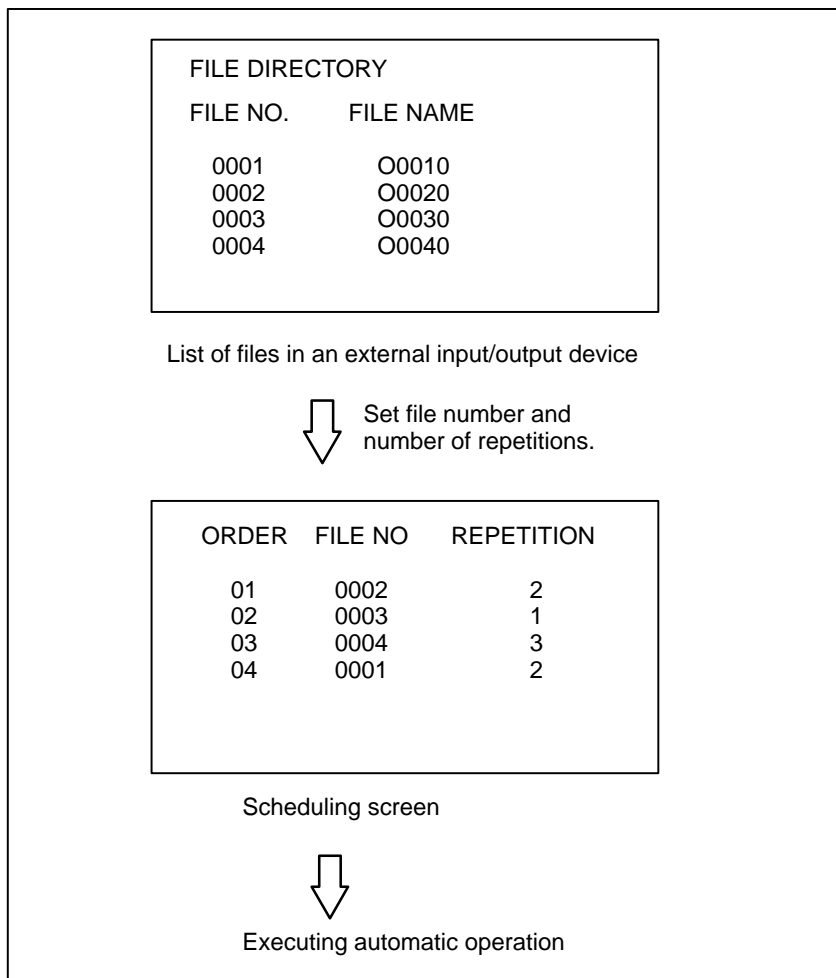
WARNING

As a rule, the tool cannot be returned to a correct position under the following conditions. Special care must be taken in the following cases since none of them cause an alarm:

- Manual operation is performed when the manual absolute mode is OFF.
- Manual operation is performed when the machine is locked.
- When the mirror image is used.
- When manual operation is performed in the course of axis movement for returning operation.
- When the program restart is commanded for a block between the block for skip cutting and subsequent absolute command block.

4.6 SCHEDULING FUNCTION


The schedule function allows the operator to select files (programs) registered on a floppy-disk in an external input/output device (Handy File, Floppy Cassette, or FA Card) and specify the execution order and number of repetitions (scheduling) for performing automatic operation. It is also possible to select only one file from the files in the external input/output device and execute it during automatic operation. This function is effective, when the floppy cassette directory display option is available and the floppy cassette is selected as the valid I/O device.



Procedure for Scheduling Function

Procedure

• Procedure for executing one file

- 1 Press the **MEMORY** switch on the machine operator's panel, then press the  function key on the MDI panel.
- 2 Press the rightmost soft key (continuous menu key), then press the **[FL. SDL]** soft key. A list of files registered in the Floppy Cassette is displayed on screen No. 1. To display more files that are not displayed on this screen, press the page key on the MDI panel. Files registered in the Floppy Cassette can also be displayed successively.

FILE DIRECTORY		O0001 N00000
CURRENT SELECTED : SCHEDULE		
NO.	FILE NAME	(METER) VOL
0000	SCHEDULE	
0001	PARAMETER	58.5
0002	ALL PROGRAM	11.0
0003	O0001	1.9
0004	O0002	1.9
0005	O0010	1.9
0006	O0020	1.9
0007	O0040	1.9
0008	O0050	1.9
MEM **** * * * * *		19 : 14 : 47
{ PRGRM }	{ DIR }	{ SCHEDUL } { (OPRT) }

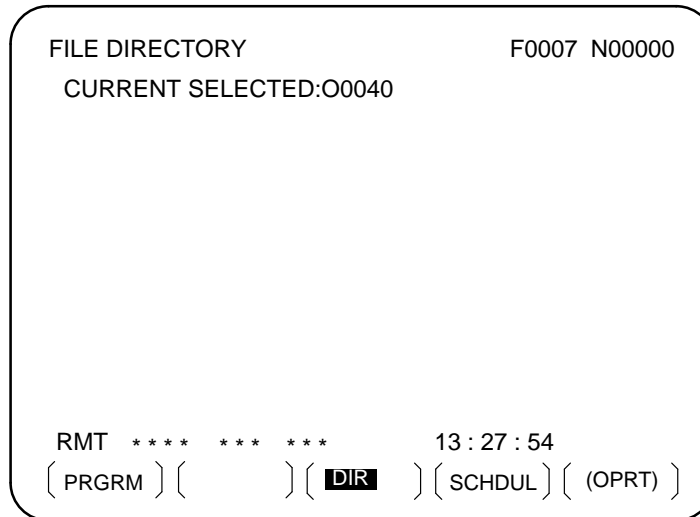
Screen No.1

- 3 Press the **[(OPRT)]** and **[SELECT]** soft keys to display "SELECT FILE NO." (on screen No. 2). Enter a file number, then press the **[F SET]** and **[EXEC]** soft keys. The file for the entered file number is selected, and the file name is indicated after "CURRENT SELECTED:".

FILE DIRECTORY		O0001 N00000
CURRENT SELECTED:O0040		
NO.	FILE NAME	(METER) VOL
0000	SCHEDULE	
0001	PARAMETER	58.5
0002	ALL PROGRAM	11.0
0003	O0001	1.9
0004	O0002	1.9
0005	O0010	1.9
0006	O0020	1.9
0007	O0040	1.9
0008	O0050	1.9
SELECT FILE NO.=7		
MEM **** * * * * *		19 : 17 : 10
{ F SET }	{ EXEC }	

Screen No.2

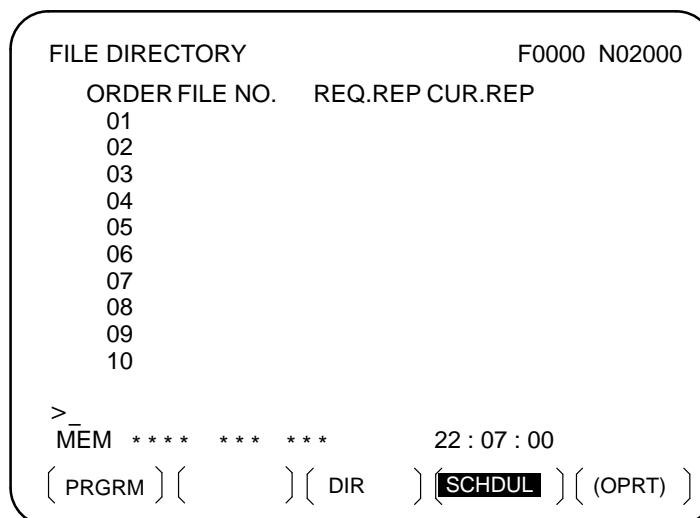
- 4 Press the **REMOTE** switch on the machine operator's panel to enter the **RMT** mode, then press the cycle start switch. The selected file is executed. For details on the **REMOTE** switch, refer to the manual supplied by the machine tool builder. The selected file number is indicated at the upper right corner of the screen as an F number (instead of an O number).



Screen No.3

● **Procedure for executing the scheduling function**

- 1 Display the list of files registered in the Floppy Cassette. The display procedure is the same as in steps 1 and 2 for executing one file.
- 2 On screen No. 2, press the **[(OPRT)]** and **[SELECT]** soft keys to display "SELECT FILE NO."
- 3 Enter file number 0, and press the **[F SET]**, and **[EXEC]** soft keys. "SCHEDULE" is indicated after "CURRENT SELECTED:".
- 4 Press the leftmost soft key (return menu key) and the **[SCHEDUL]** soft key. Screen No. 4 appears.



Screen No.4

Move the cursor and enter the file numbers and number of repetitions in the order in which to execute the files. At this time, the current number of repetitions "CUR.REP" is 0.

- 5 Press the **REMOTE** switch on the machine operator's panel to enter the **RMT** mode, then press the start switch. The files are executed in the specified order. When a file is being executed, the cursor is positioned at the number of that file.
The current number of repetitions CUR.REP is increased when M02 or M30 is executed in the program being run.

FILE DIRECTORY		O0000 N02000	
ORDER	FILE NO.	REQ.REP	CUR.REP
01	0007	5	5
02	0003	23	23
03	0004	9999	156
04	0005	LOOP	0
05			
06			
07			
08			
09			
10			

RMT ***** 10 : 10 : 40

{ PRGRM } { } { DIR } { SCHEDUL } { (OPRT) }

Screen No.5

Explanations

- **Specifying no file number**

If no file number is specified on screen No. 4 (the file number field is left blank), program execution is stopped at that point. To leave the file number field blank, press numeric key then .

- **Endless repetition**

If a negative value is set as the number of repetitions, <LOOP> is displayed, and the file is repeated indefinitely.

- **Clear**

When the **{(OPRT)}**, **[CLEAR]**, and **[EXEC]** soft keys are pressed on screen No. 4, all data is cleared. However, these keys do not function while a file is being executed.

- **Return to the program screen**

When the soft key **[PRGRM]** is pressed on screen No. 1, 2, 3, 4, or 5, the program screen is displayed.

Restrictions

- **Number of repetitions**

Up to 9999 can be specified as the number of repetitions. If 0 is set for a file, the file becomes invalid and is not executed.

- **Number of files registered**

By pressing the page key on screen No. 4, up to 20 files can be registered.

- **M code**

When M codes other than M02 and M30 are executed in a program, the current number of repetitions is not increased.

- **Displaying the floppy disk directory during file execution**
- **Restarting automatic operation**
- **Scheduling function for the two-path control**

During the execution of file, the floppy directory display of background editing cannot be referenced.

To resume automatic operation after it is suspended for scheduled operation, press the reset button.

The scheduling function can be used only for a single tool post.

Alarm

Alarm No.	Description
086	An attempt was made to execute a file that was not registered in the floppy disk.
210	M198 and M099 were executed during scheduled operation, or M198 was executed during DNC operation.

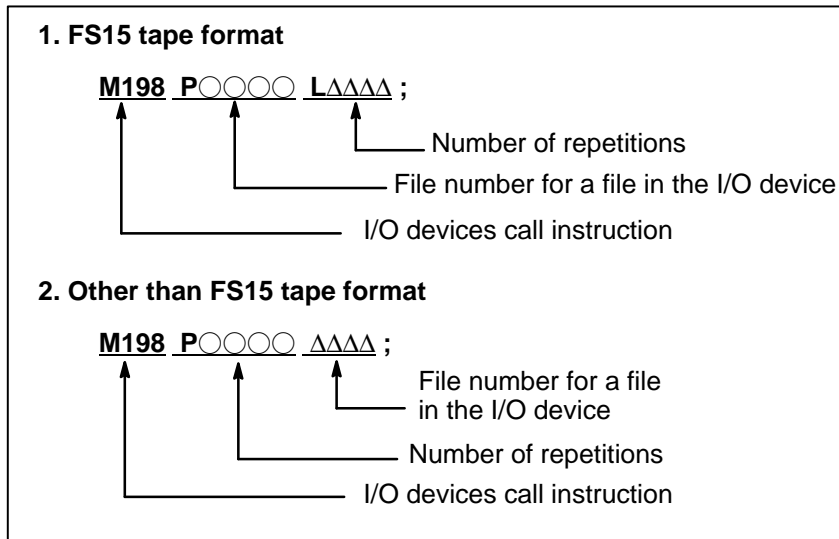
4.7 SUBPROGRAM CALL FUNCTION (M198)

The subprogram call function is provided to call and execute subprogram files stored in an external input/output device(Handy File, FLOPPY CASSETTE, FA Card)during memory operation.

When the following block in a program in CNC memory is executed, a subprogram file in the external input/output device is called:

To use this function, the Floppy Cassette directory display option must be installed.

Format



Explanation

The subprogram call function is enabled when parameter No.0102 for the input/output device is set to 3. When the custom macro option is provided, either format 1 or 2 can be used. A different M code can be used for a subprogram call depending on the setting of parameter No.6030. In this case, M198 is executed as a normal M code. The file number is specified at address P. If the SBP bit (bit 2) of parameter No.3404 is set to 1, a program number can be specified. When a file number is specified at address P, Fxxxx is indicated instead of Oxxxx.

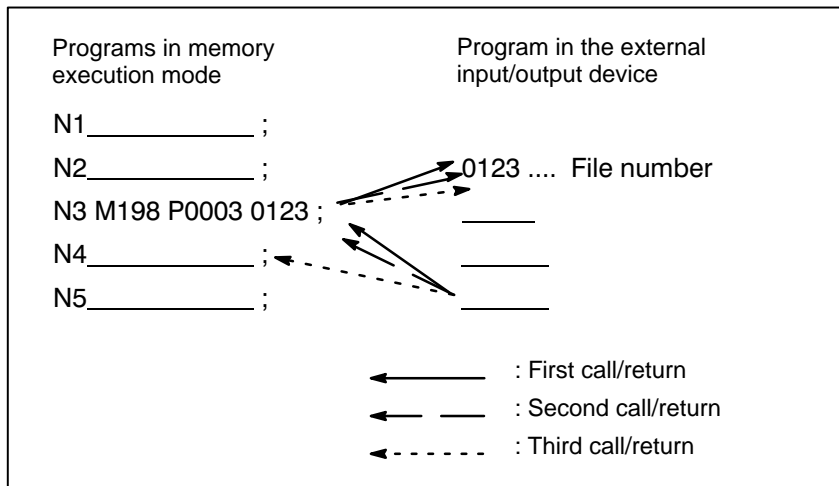


Fig.4.7 (a) Program Flow When M198 is Specified

Restrictions

- **Subprogram call function with two-path control**

For the two-path control, subprograms in a floppy cassette cannot be called for the two tool posts at the same time.

NOTE

- 1 When M198 in the program of the file saved in a floppy cassette is executed, a P/S alarm (No.210) is given. When a program in the memory of CNC is called and M198 is executed during execution of a program of the file saved in a floppy cassette, M198 is changed to an ordinary M-code.
- 2 When MDI is intervened and M198 is executed after M198 is commanded in the memory mode, M198 is changed to an ordinary M-code. When the reset operation is done in the MDI mode after M198 is commanded in the MEMORY mode, it does not influence on the memory operation and the operation is continued by restarting it in the MEMORY mode.

4.8 MANUAL HANDLE INTERRUPTION

The movement by manual handle operation can be done by overlapping it with the movement by automatic operation in the automatic operation mode.

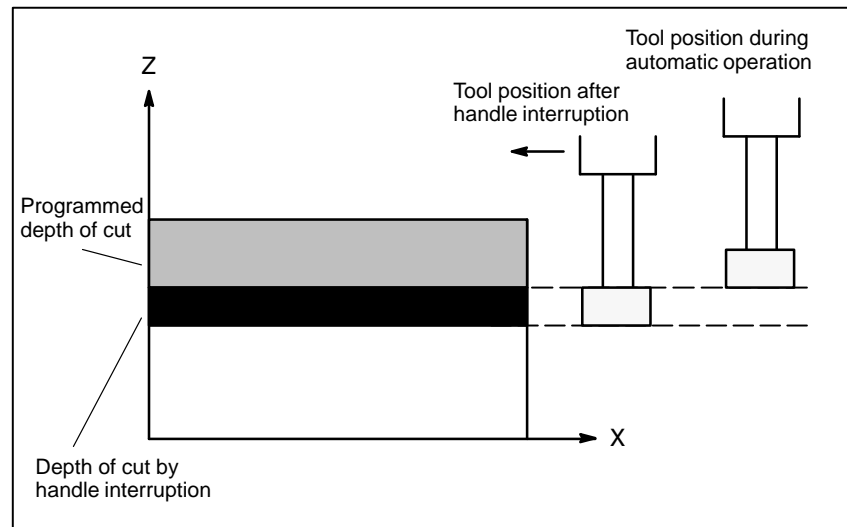


Fig 4.8 (a) Manual Handle Interruption

- **Handle interruption axis selection signals**
For the handle interruption axis selection signals, refer to the manual supplied by the machine tool builder.
During automatic operation, handle interruption is enabled for an axis if the handle interruption axis selection signal for that axis is on. Handle interruption is performed by turning the handle of the manual pulse generator.

WARNING

The travel distance by handle interruption is determined according to the amount by which the manual pulse generator is turned and the handle feed magnification (x1, x10, xM, xN).

Since this movement is not accelerated or decelerated, it is very dangerous to use a large magnification value for handle interruption.

The move amount per scale at x1 magnification is 0.001 mm (metric output) or 0.0001 inch (inch output).

NOTE

Handle interruption is disabled when the machine is locked during automatic operation.

Explanations

- **Relation with other functions**

The following table indicates the relation between other functions and the movement by handle interrupt.

Display	Relation
Machine lock	Machine lock is effective. The tool does not move even when this signal turns on.
Interlock	Interlock is effective. The tool does not move even when this signal turns on.
Mirror image	Mirror image is not effective. Interrupt functions on the plus direction by plus direction command, even if this signal turns on.

- **Position display**

The following table shows the relation between various position display data and the movement by handle interrupt.

Display	Relation
Absolute coordinate value	Handle interruption does not change absolute coordinates.
Relative coordinate value	Handle interruption does not change relative coordinates.
Machine coordinate value	Machine coordinates are changed by the travel distance specified by handle interruption.

- **Travel distance display**

Press the function key POS, then press the chapter selection soft key **[HNDL]**.

The move amount by the handle interrupt is displayed. The following 4 kinds of data are displayed concurrently.

HANDLE INTERRUPTION		O0000 N02000	
(INPUT UNIT)		(OUTPUT UNIT)	
X	69.594	X	69.594
Y	137.783	Y	137.783
Z	-61.439	Z	-61.439
(RELATIVE)		(DISTANCE TO GO)	
X	0.000	X	0.000
Y	0.000	Y	0.000
Z	0.000	Z	0.000
RUN TIME 1H 12M		PART COUNT 287	
		CYCLE TIME 0H 0M 0S	
MDI *****		10 : 29 : 51	
{ ABS }	{ REL }	{ ALL }	{ HNDL }
			{ (OPRT) }

- (a) INPUT UNIT : Handle interrupt move amount in input unit system
Indicates the travel distance specified by handle interruption according to the least input increment.
- (b) OUTPUT UNI : Handle interrupt move amount in output unit system
Indicates the travel distance specified by handle interruption according to the least command increment.
- (c) RELATIVE : Position in relative coordinate system
These values have no effect on the travel distance specified by handle interruption.
- (d) DISTANCE TO GO : The remaining travel distance in the current block has no effect on the travel distance specified by handle interruption.

The handle interrupt move amount is cleared when the manual reference position return ends every axis.

4.9 MIRROR IMAGE

During automatic operation, the mirror image function can be used for movement along an axis. To use this function, set the mirror image switch to ON on the machine operator's panel, or set the mirror image setting to ON from the MDI panel.

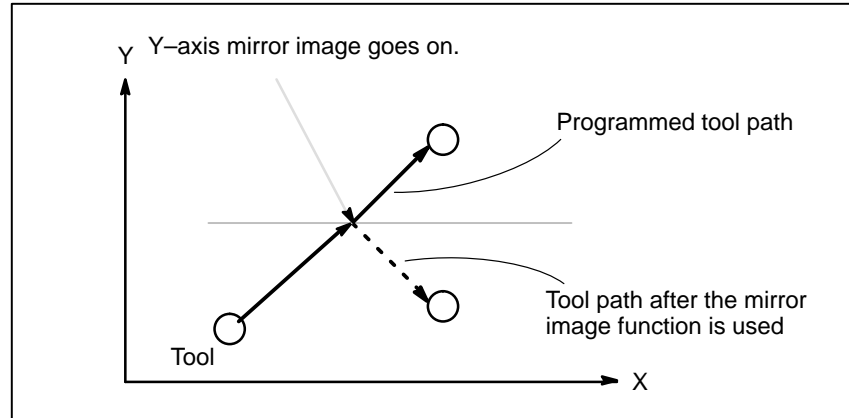

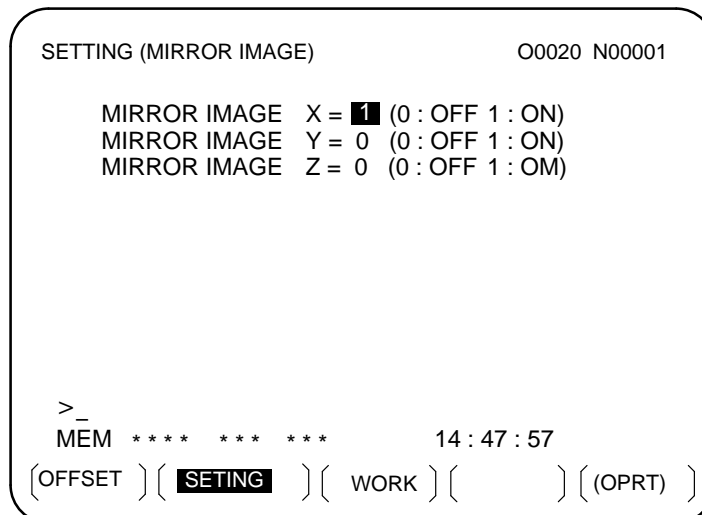


Fig 4.9 (a) Mirror Image

Procedure

The following procedure is given as an example. For actual operation, refer to the manual supplied by the machine tool builder.

- 1 Press the single block switch to stop automatic operation. When the mirror image function is used from the beginning of operation, this step is omitted.
- 2 Press the mirror image switch for the target axis on the machine operator's panel.
Alternatively, turn on the mirror image setting by following the steps below:
 - 2-1 Set the **MDI** mode.
 - 2-2 Press the  function key.
 - 2-3 Press the **[SETTING]** soft key for chapter selection to display the setting screen.



2-4 Move the cursor to the mirror image setting position, then set the target axis to 1.

3 Enter an automatic operation mode (memory mode or MDI mode), then press the cycle start button to start automatic operation.

Explanations

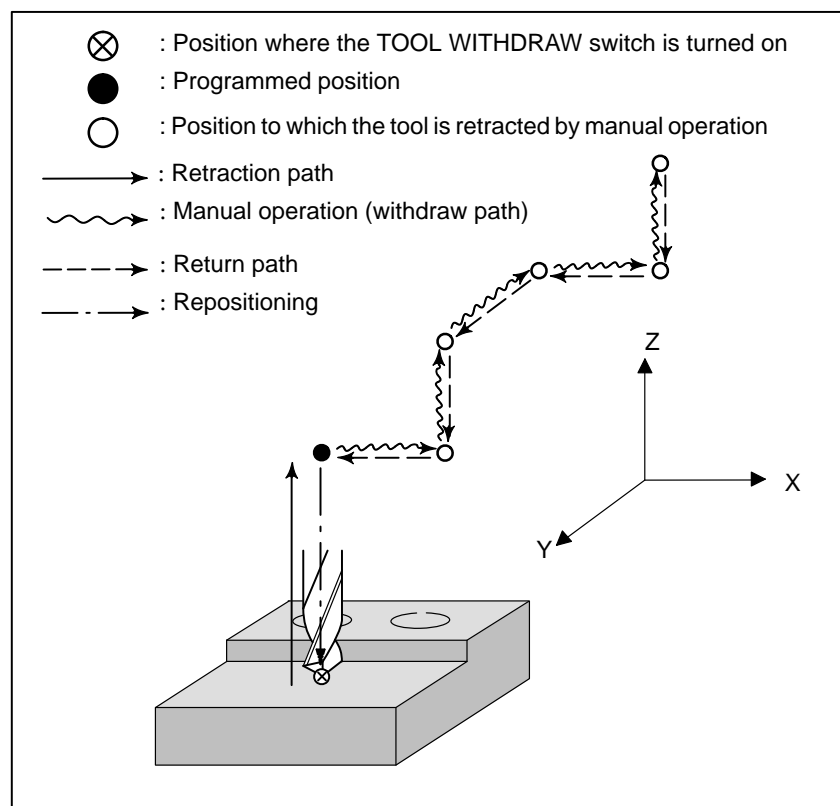
- The mirror image function can also be turned on and off by setting bit 0 of parameter 0012 (MIRx) to 1 or 0.
- For the mirror image switches, refer to the manual supplied by the machine tool builder.

Limitations

The direction of movement during manual operation, the direction of movement from an intermediate point to the reference position during automatic reference position return (G28), the direction of approach during unidirectional positioning (G60), and the shift direction in a boring cycle (G76, G87) cannot be reserved.

4.10 TOOL WITHDRAWAL AND RETURN

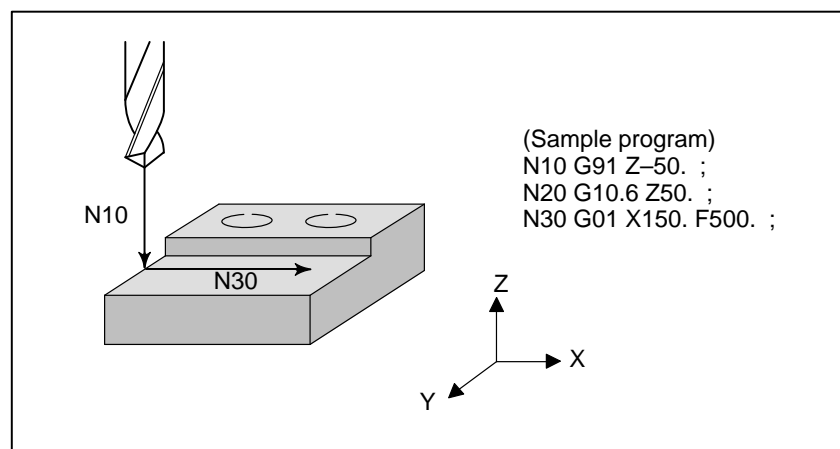
The tool can be withdrawn from a workpiece in order to replace the tool when it is damaged during machining, or merely to check the status of machining. The tool can then be advanced again to restart machining efficiently.



Procedure for tool withdrawal and return

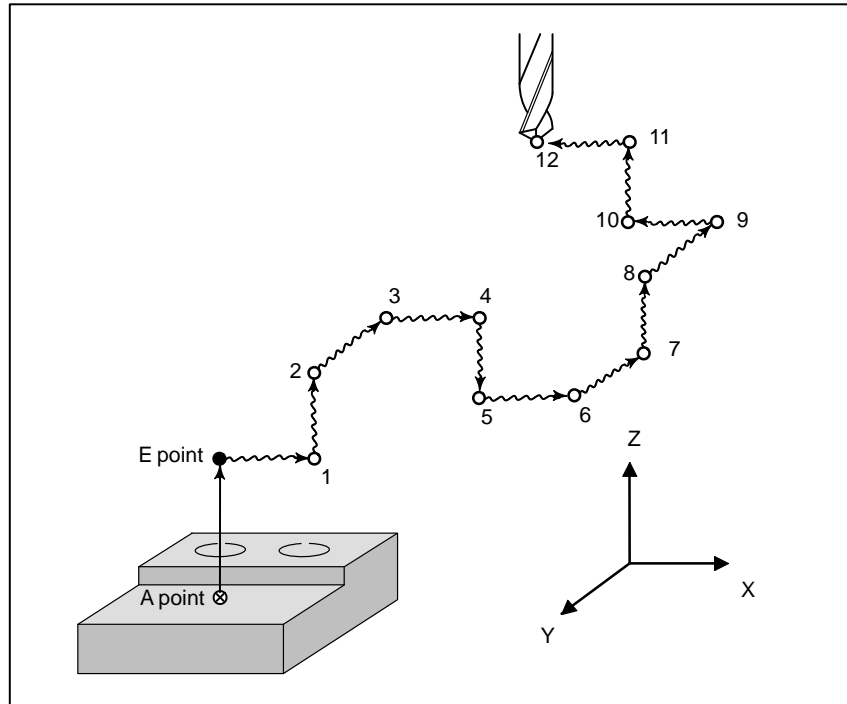
Procedure1 Programming

Specify a retraction axis and distance in command G10.6IP_ beforehand. In the sample program below, the N20 block specifies that the Z-axis is the retraction axis and the retraction distance is to be 50 mm.



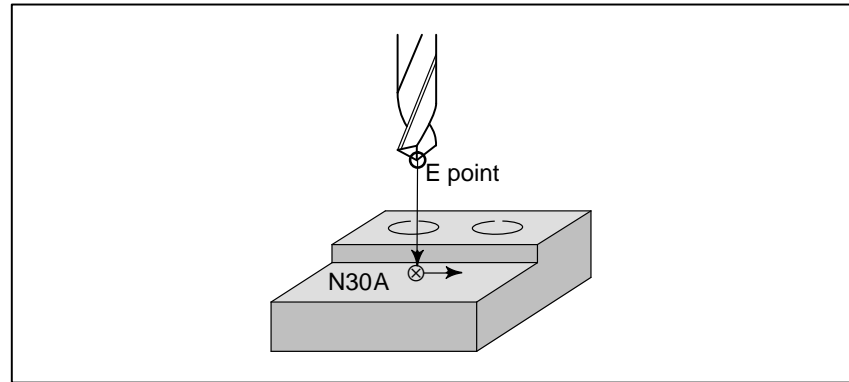
Procedure3
Withdrawal

Set the manual operation mode, then withdraw the tool. For manual operation, either jog feed or handle feed is possible.



Procedure 5 Repositioning

While the tool is at the retraction position (point E in the figure below) and the RETRACTION POSITION LED is on, press the cycle start switch. The tool is then repositioned at the point where retraction was started (i.e. where the TOOL WITHDRAW switch was turned on).

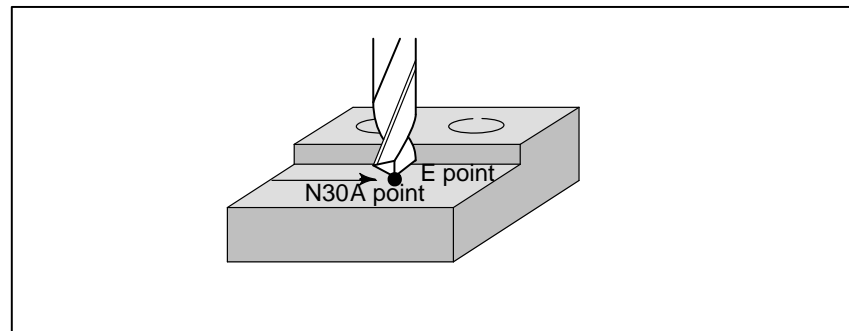


Upon completion of repositioning, the tool withdraw mode is cancelled, and the TOOL BEING WITHDRAWN LED goes off and restart N30.

Explanation 1 Retraction

- **When no retraction distance is specified**

If no retraction distance or direction required for retraction are specified, retraction is not performed when the TOOL WITHDRAW switch on the operator's panel is turned on. Instead, the block being executed in automatic operation is interrupted (automatic operation is held or stopped). In this state, the tool can be withdrawn and returned.



- **Retraction from the automatic operation hold or stop state**

When the single block switch is turned on during automatic operation, or the TOOL WITHDRAW switch is turned on after the automatic operation hold or stop state is set by feed hold: Retraction is performed, then the automatic operation hold or stop state is set again.

- **Stopping retraction**

During retraction, feed hold operation is ignored. However, reset operation is enabled (retraction is stopped at reset). When an alarm is issued during retraction, the retraction is stopped immediately.

- **Repositioning immediately after retraction**

After retraction is completed, tool repositioning can be started without performing the withdraw and return operations.

Explanation 2 Withdrawal

- **Axis selection** To move the tool along an axis, select the corresponding axis selection signal. Never specify axis selection signals for two or more axes at a time.
- **Path memorization** When the tool is moved in manual operation along an axis, the control unit memorizes up to ten paths of movements. If the tool is stopped after being moved along a selected axis and is then moved along another selected axis, the position where this switch takes place is memorized. After ten paths have been memorized, the control unit does not memorize any additional switching points.
- **Reset** Upon reset, memorized position data is lost and the tool withdraw mode is cancelled.

Explanation 3 Return

- **Return path** When there are more than ten return paths, the tool first moves to the tenth position, then to the ninth position, then to the eighth position, and so forth until the retraction position is reached.
- **Single block** The single block switch is enabled during return operation. If the single block switch is turned off, continuous return operation is performed. If the single block switch is turned on, the tool stops at each memorized position. In this case, return operation can be resumed by turning the TOOL RETURN switch on then off again.
- **Interruption of return operation** When an alarm is issued during return operation, return operation stops.
- **Feed hold** The feed hold function is enabled during return operation.

Explanation 4 Repositioning

- **Feed hold** The feed hold function is disabled during repositioning.
- **Operation after completion of repositioning** The operation after completion of repositioning depends on the automatic operation state present when the TOOL WITHDRAW switch is turned on.
 1. When automatic operation is being started
After completion of repositioning, the interrupted execution of the block is resumed.
 2. When automatic operation is held or stopped
After completion of repositioning, the tool stops once at the repositioned point, then the original automatic operation hold or stop state is set. When the cycle start switch is pressed, automatic operation is resumed.

4.11 RETRACE FUNCTION

With the retrace function, the tool can be moved in the reverse direction (reverse movement) by using the REVERSE switch during automatic operation to trace the programmed path. The retrace function also enables the user to move the tool in the forward direction again (forward return movement) along the retraced path until the retrace start position is reached. When the tool reaches the retrace start position, the tool resumes movement according to the program.

Procedure for Retrace Operation

Procedure

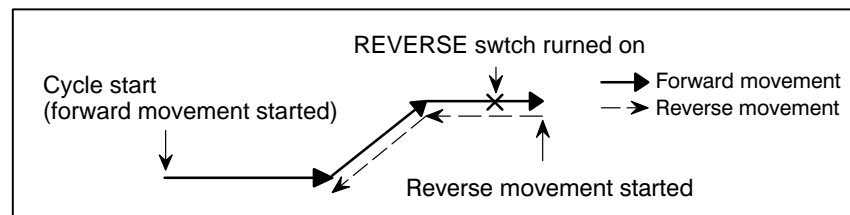
- **Forward movement** →
- **Reverse movement**

To move the tool in the forward direction, turn off the REVERSE switch on the operator's panel, then press the cycle start switch. If the REVERSE switch on the operator's panel is on, the tool moves in the reverse direction or completes reverse movement.

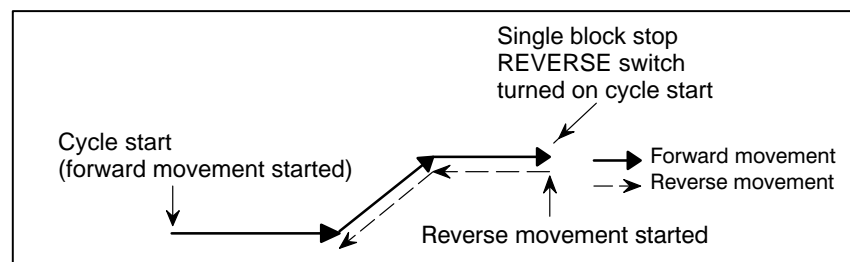
Three methods are available for moving the tool in the reverse direction along the programmed path.

- 1) When the tool is moving in the forward direction, turn on the REVERSE switch on the operator's panel during block execution.
- 2) When the tool is moving in the forward direction, turn on the REVERSE switch on the operator's panel after a single block stop.
- 3) When the tool is moving in the forward direction, turn on the REVERSE switch on the operator's panel after a feed hold stop.

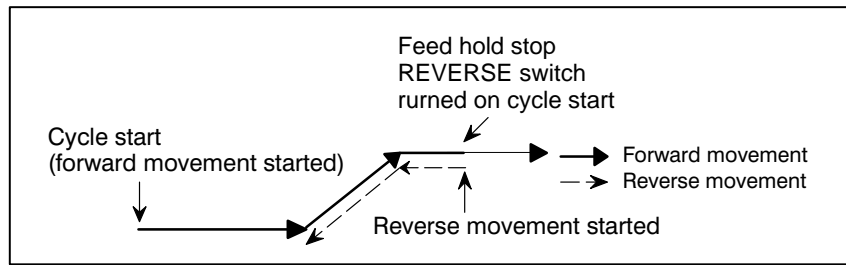
In the case of 1) above, the tool starts reverse movement after completion of the block currently being executed (after execution up to the position of a single block stop). Turning on the REVERSE switch on the operator's panel does not immediately start reverse movement.



In the case of 2) above, the tool starts reverse movement at the position of a single block stop when the cycle start switch is pressed.



In the case of 3) above, the tool starts reverse movement at the position of a feed hold stop when the cycle start switch is pressed.

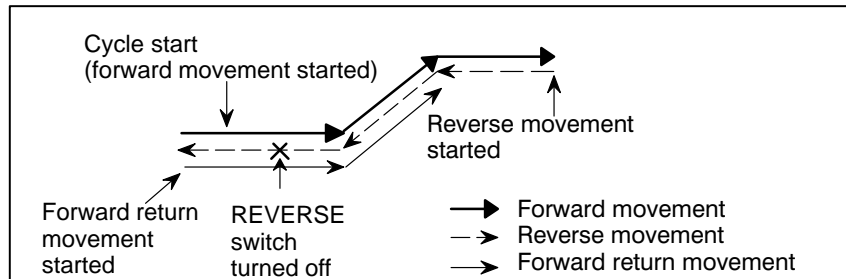


● **Reverse movement → Forward return movement**

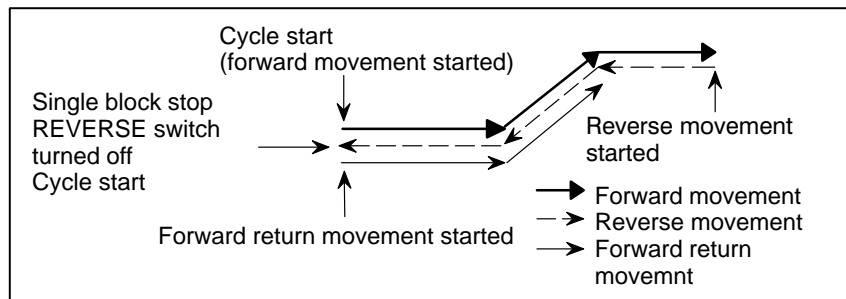
Three methods are available for moving the tool in the forward direction again along the retraced path.

- 1) When the tool is moving in the reverse direction, turn off the REVERSE switch on the operator's panel during block execution.
- 2) When the tool is moving in the reverse direction, turn off the REVERSE switch on the operator's panel after a single block stop.
- 3) When the tool is moving in the reverse direction, turn off the REVERSE switch on the operator's panel after a feed hold stop.

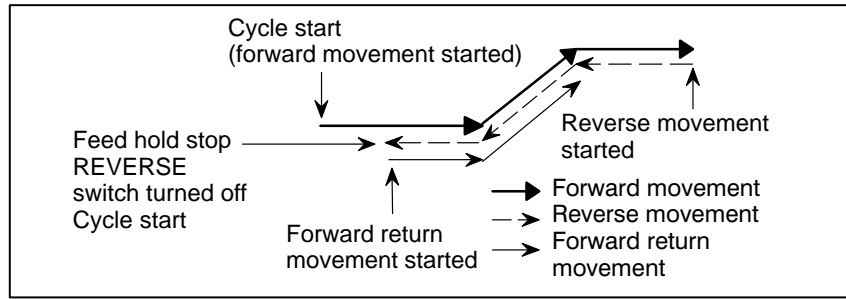
In the case of 1) above, the tool starts forward return movement after completion of the block currently being executed (after execution up to the position of a single block stop). Turning off the REVERSE switch on the operator's panel does not immediately start forward return movement.



In the case of 2) above, the tool starts forward return movement at the position of a single block stop when the cycle start switch is pressed.



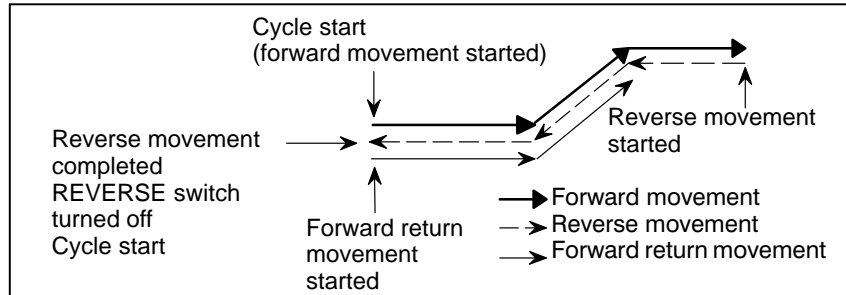
In the case of 3) above, the tool starts forward return movement at the position of a feed hold stop when the cycle start switch is pressed.



- Reverse movement → Reverse movement completion → Forward return movement

When there are no more blocks for which to perform reverse movement (when the tool has moved back to the initial forward movement block or the tool has not yet started forward movement), the reverse movement completion state is entered and operation stops.

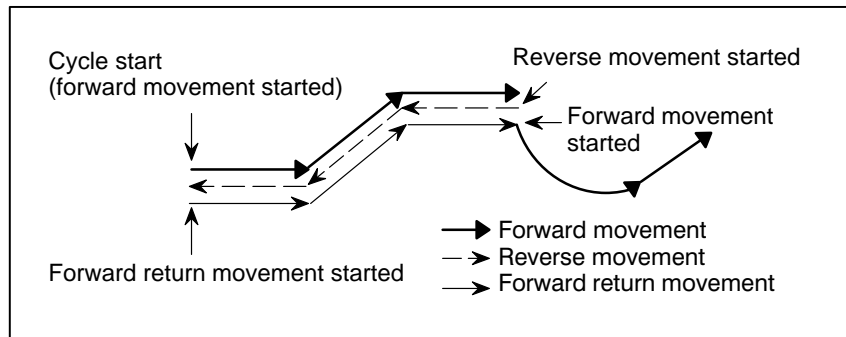
Even when the cycle start switch is pressed with the REVERSE switch on the operator's panel turned on, no operation is performed (the reverse movement completion state remains unchanged). When the cycle start switch is pressed after turning off the REVERSE switch on the operator's panel, the tool starts forward return movement or forward movement.



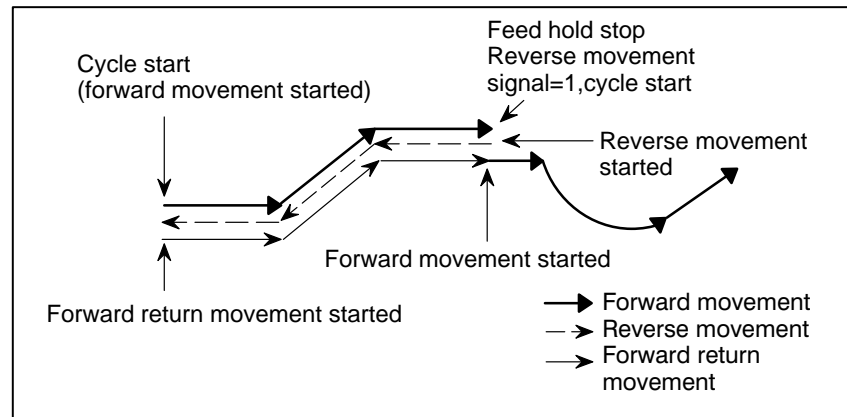
- Forward return movement → Forward movement

When the tool completes a forward return movement up to the block where reverse movement was started, the tool automatically resumes forward movement. Programmed commands are read and program execution is continued. No particular operation is required to resume forward movement.

When tool movement switches from forward return movement to forward movement, the display of RTRY (Re-TRY) in the lower-right corner of the CRT screen disappears.



If the tool moves in the reverse direction after a feed hold stop, the tool stops forward return movement at the position of the feed hold stop, then resumes forward movement. If the tool moves in the reverse direction after a single block stop, the tool also stops forward return movement at the position of the single block stop.



Explanations

- **Forward movement and reverse movement**

In automatic operation, a program is usually executed in the order that commands are specified. This mode of execution is referred to as forward movement. The retrace function can execute in reverse, program blocks that have already been executed. This mode of execution is referred to as reverse movement. In reverse movement, the tool can retrace the tool path followed by forward movement.

A program can be executed in the reverse direction only for those blocks that have already been executed in the forward direction.

Approximately 40 to 80 blocks can be executed in the reverse direction, depending on the program.

During reverse movement, the REVERSE MOVEMENT LED is on and RVRS blinks in the lower-right corner of the screen to indicate that the tool is undergoing reverse movement.

The tool can perform reverse movement one block at a time when the single block mode is set.

- **Forward return movement**

The tool can be moved again along the retraced path of the blocks in the forward direction up to the block where reverse movement was started. This movement is referred to as forward return movement. In forward return movement, the tool moves along the same path as forward movement up to the position where reverse movement started.

When the tool returns to the block where reverse movement was started, the tool resumes forward movement according to the program.

In forward return movement, the REVERSE MOVEMENT LED is off and RTRY (Re-TRY) blinks in the lower-right corner of the screen to indicate that the tool is undergoing forward return movement. When the tool switches from forward return movement to forward movement, RTRY (Re-TRY) disappears from the lower-right corner of the screen.

The tool can perform forward return movement one block at a time when the single block mode is set.

- **Reverse movement completion**

When there are no more blocks for which to perform reverse movement (when the tool has moved back along the path of all memorized blocks or the tool has not yet started forward movement), operation stops. This is referred to as reverse movement completion.

Upon reverse movement completion, the REVERSE MOVEMENT LED goes off, and RVED (ReVerse EnD) blinks in the lower-right corner of the screen to indicate that reverse movement is completed.

- **Reset**

Upon reset (when the RESET key on the MDI panel is pressed, the external reset signal is applied, or the reset and rewind signal is applied), the memorized reverse movement blocks are cleared.
- **Feedrate**

A feedrate for reverse movement can be specified using parameter (No. 1414). When this parameter is set to 0, the feedrate used for forward movement is used.

For forward return movement, the feedrate for forward movement is always used.

In reverse movement and forward return movement, the feedrate override function, rapid traverse override function, and dry run function are enabled.

Limitations

- **Block that disables reverse movement**

Reverse movement stops when any of the commands or modes listed below appears. If an attempt is made during forward movement to stop forward movement with feed hold stop and then move the tool in the reverse direction when any of the commands and modes below is specified, the reverse movement completion state occurs.

 - Involute interpolation (G02.2/ G03.2)
 - Exponential interpolation (G02.3/ G03.3)
 - Cylindrical interpolation (G07.1, G107)
 - Polar coordinate interpolation mode (G12.1)
 - Inch/metric conversion (G20/ G21)
 - Reference position return check (G27)
 - Return to reference position (G28)
 - Return from reference position (G29)
 - 2nd, 3rd, and 4th reference position return (G30)
 - Floating reference position return (G30.1)
 - Thread cutting (G33)
 - Machine coordinate system selection (G53)
 - Chopping operation command (G81.1)
(See the chopping function described later.)
 - Rigid tapping cycle (M29, G84)
 - High speed cycle machining (G05)
 - High speed remote buffer A (G05)
 - High speed remote buffer B (G05)
 - High precision contour control (RISC) (G05)
 - Look-ahead control (G08)
 - Cs contour control

- **Circular interpolation(G02,G03)**

Be sure to specify the radius of an arc with R.

WARNING

If an end point is not correctly placed on an arc (if a leading line is produced) when an arc center is specified using I, J, and K, the tool does not perform correct reverse movement.

- **Interrupt-type custom macro**

1. Never initiate an interrupt during reverse movement.
2. Never perform reverse movement for an interrupted block and the program that has issued the interrupt.

- **Tool life management**

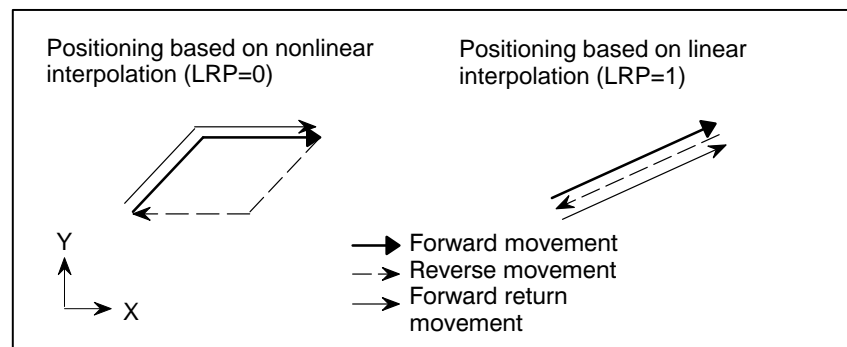
The retrace function does not support the tool life management function.

- **Switching automatic operation mode**

If the operation mode is switched after a single block stop from memory operation to MDI operation or vice versa during reverse movement or forward return movement, reverse movement, forward return movement, and forward movement can no longer be performed. To restart operation, return the mode to the original mode, then press the cycle start switch.

- **Positioning (G00)**

When the tool is positioned based on nonlinear interpolation by setting bit 1 (LRP) of parameter No. 1401 to 0, the path of the tool for reverse movement does not match the path for forward movement. The path for forward return movement is the same as the path for forward movement. When the tool is positioned based on linear interpolation by setting bit 1 (LRP) of parameter No. 1401 to 1, the path of the tool for reverse movement matches the path for forward movement.



- **Dwell (G04)**

The dwell command (G04) is executed in reverse movement and forward return movement in the same way as during ordinary operation.

- **Programmable data setting (G10)**

A tool compensation value, parameter, pitch error data, workpiece zero point offset value, and tool life management setting specified or modified using the programmable data setting code (G10) are ignored in reverse movement and forward return movement.

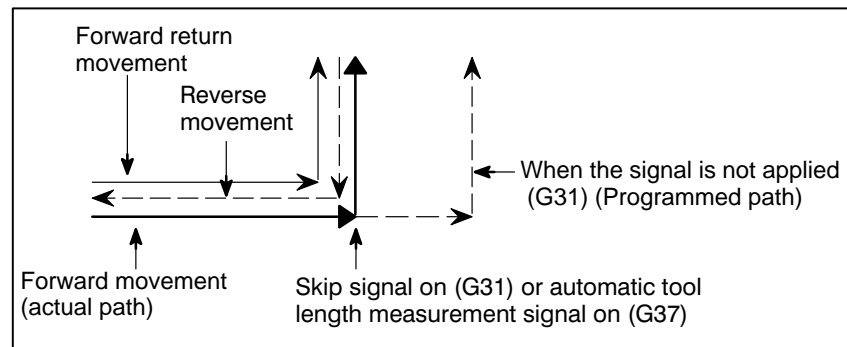
- **Stored stroke check function on/off (G22,G23)**

The on/off state of the stored stroke check function present at the end of forward movement remains unchanged during reverse movement and forward return movement. This means that the actual on/off state may differ from the modal G22/G23 indication. When reverse movement or forward return movement is cancelled upon reset, the modal G22/G23 indication at that time becomes valid.

The setting of an area with G22 X_Y_Z_I_J_K at the end of forward movement remains unchanged.

- **Skip function (G31), automatic tool length measurement (G37)**

In reverse movement and forward return movement, the skip signal and automatic tool length measurement signal are ignored. In reverse movement and forward return movement, the tool moves along the path actually followed in forward movement.



- **Chopping function (G81.1)**

Whether the chopping operation is performed in reverse movement and forward return movement is determined by whether the chopping operation was performed at the end of forward movement.

If the tool starts reverse movement with the chopping mode off and moves in the reverse direction along the path of a block where the chopping mode is on, the chopping axis maintains its position at point R.

When a block specifying G81.1 (chopping command) appears during reverse movement, reverse movement ends and operation stops.

- **Inverse time feed (G93)**

Along the path of a block where the tool moved according to inverse time feed in forward movement, the tool moves in the reverse direction according to the feedrate specified by parameter No. 1414 (=0) for reverse movement.

If parameter No. 1414 for specifying the feedrate for reverse movement is not set (=0), the tool moves in the reverse direction at the same feedrate as during forward movement.

- **Constant surface speed control on/off (G96,G97)**

If the on/off mode of constant surface speed control is specified in reverse movement, the specified mode is used in subsequent reverse movement. In other words, when a block specifying G96Sxxxx; appears in reverse movement, constant surface speed control is on for subsequent reverse movement. When a block specifying G97Sxxxx; appears in reverse movement, constant surface speed control is off for subsequent reverse movement.

Note that the on/off mode of constant surface speed control in forward movement is reversed in reverse movement.

- **Clamping maximum spindle speed (G92Sxxxx)**

If the command for clamping maximum spindle speed is specified in reverse movement, the specified clamp is applied to subsequent reverse movement. In other words, when G92Sxxxx appears in reverse movement, the spindle speed is clamped at Sxxxx. Note, however, that the spindle speed is clamped only when the G96 mode is set.

- **Auxiliary function**

The M, S, and T functions, and secondary auxiliary functions (B functions) are output directly in reverse movement and forward return movement.

When an M, S, or T function, or secondary auxiliary function (B function) is specified in a block containing a move command, the function and the move command are output at the same time in forward movement, reverse movement, and forward return movement. This means that the position where an M, S, or T function, or secondary auxiliary function (B function) is output differs in forward movement, reverse movement, and forward return movement.
- **Tool compensation value**

Even if a cutter compensation value or tool length compensation value is modified in reverse movement or forward return movement, the tool moves according to the compensation value used when the block was executed in the forward movement.
- **Custom macro operation**

All custom macro operations are ignored in reverse movement and forward return movement.

The values of macro variables present at the end of forward movement remain unchanged.
- **Manual intervention**

When the tool has been moved by manual intervention, return the tool to the original position before moving the tool in the reverse direction after a feed hold stop or single block stop. In reverse movement, the tool cannot move along the path made during manual intervention. All movements made by manual intervention are ignored in reverse movement and forward return movement.
- **Tool withdrawal and return function**

The tool cannot move along the path retraction or repositioning performed using the tool withdrawal and return function. All retraction and repositioning operations are ignored in reverse movement and forward return movement.
- **Mirror image**

When a block with the mirror image function specified by a signal or setting is memorized in forward movement, the mirror image function is eliminated; the block is memorized as originally programmed.

Accordingly, in reverse movement and forward return movement, the tool moves along the programmed path. In reverse movement or forward return movement, the mirror image function can be specified by a signal or setting.

When the tool performs reverse movement or forward return movement for a block where the mirror image function is specified by the programmable mirror image code (G51.1), the tool moves along the actual path incorporating the mirror image function.

4.12 MANUAL INTERVENTION AND RETURN

In cases such as when tool movement along an axis is stopped by feed hold during automatic operation so that manual intervention can be used to replace the tool: When automatic operation is restarted, this function returns the tool to the position where manual intervention was started. To use the conventional program restart function and tool withdrawal and return function, the switches on the operator's panel must be used in conjunction with the MDI keys. This function does not require such operations.

Before this function can be used, MIN (bit 0 of parameter No. 7001) must be set to 1.

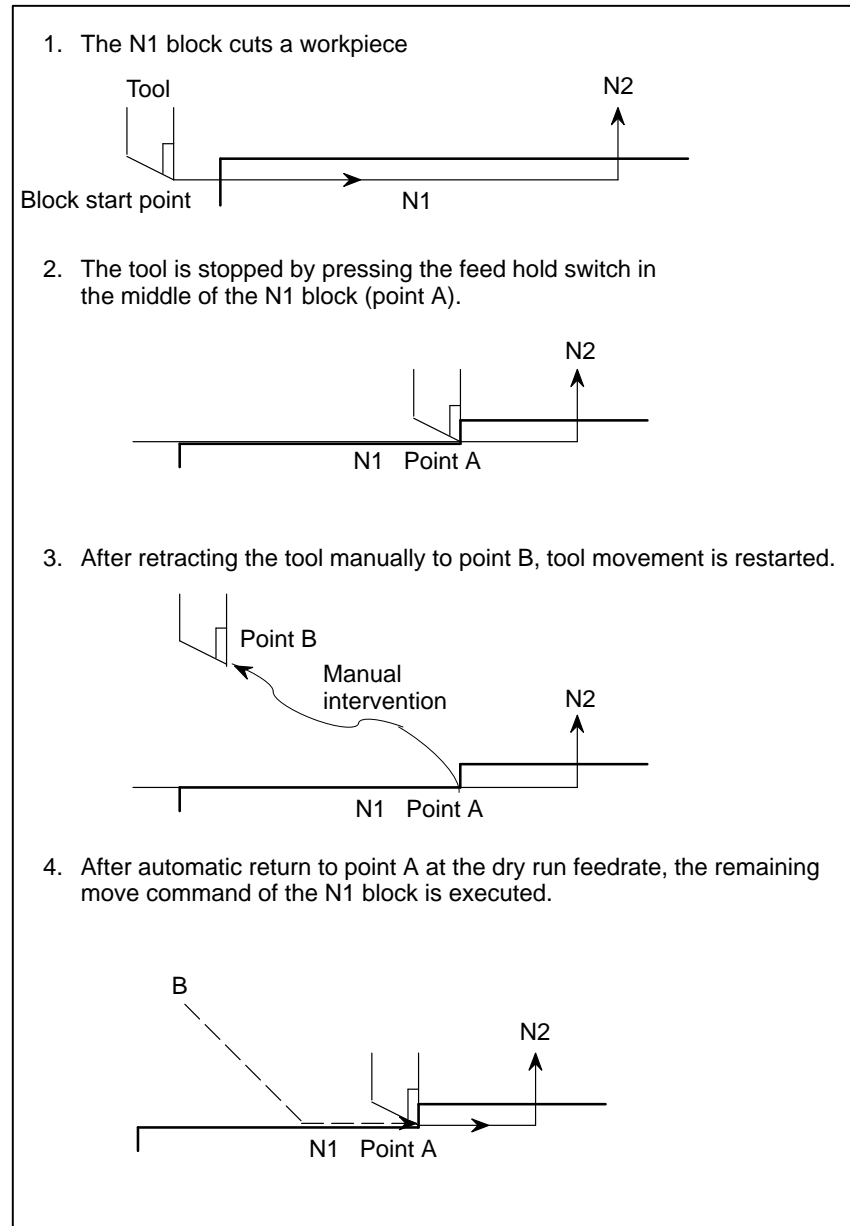
Explanations

- **Manual absolute on/off** In manual absolute off mode, the tool does not return to the stop position, but instead operates according to the manual absolute on/off function.
- **Override** For the return operation, the dry run feedrate is used, and the jog feedrate override function is enabled.
- **Return operation** Return operation is performed according to positioning based on nonlinear interpolation.
- **Single block** If the single block stop switch is on during return operation, the tool stops at the stop position and restarts movement when the cycle start switch is pressed.
- **Cancellation** If a reset occurs or an alarm is issued during manual intervention or the return operation, this function is cancelled.
- **MDI mode** This function can be used in the MDI mode as well.

Limitations

- **Enabling and disabling manual intervention and return** This function is enabled only when the automatic operation hold LED is on. When there is no travel distance remaining, this function has no effect even if a feed hold stop is performed with the automatic operation hold signal *SP (bit 5 of G008).
- **Offset** When the tool is replaced using manual intervention for a reason such as damage, the tool movement cannot be restarted by a changed offset in the middle of the interrupted block.
- **Machine lock, mirror image, and scaling** When performing manual intervention, never use the machine lock, mirror image, or scaling functions.

Example



WARNING

When performing manual intervention, pay particular attention of machining and the shape of the workpiece so that the machine and tool are not damaged.

4.13 RETREAT AND RETRY FUNCTION

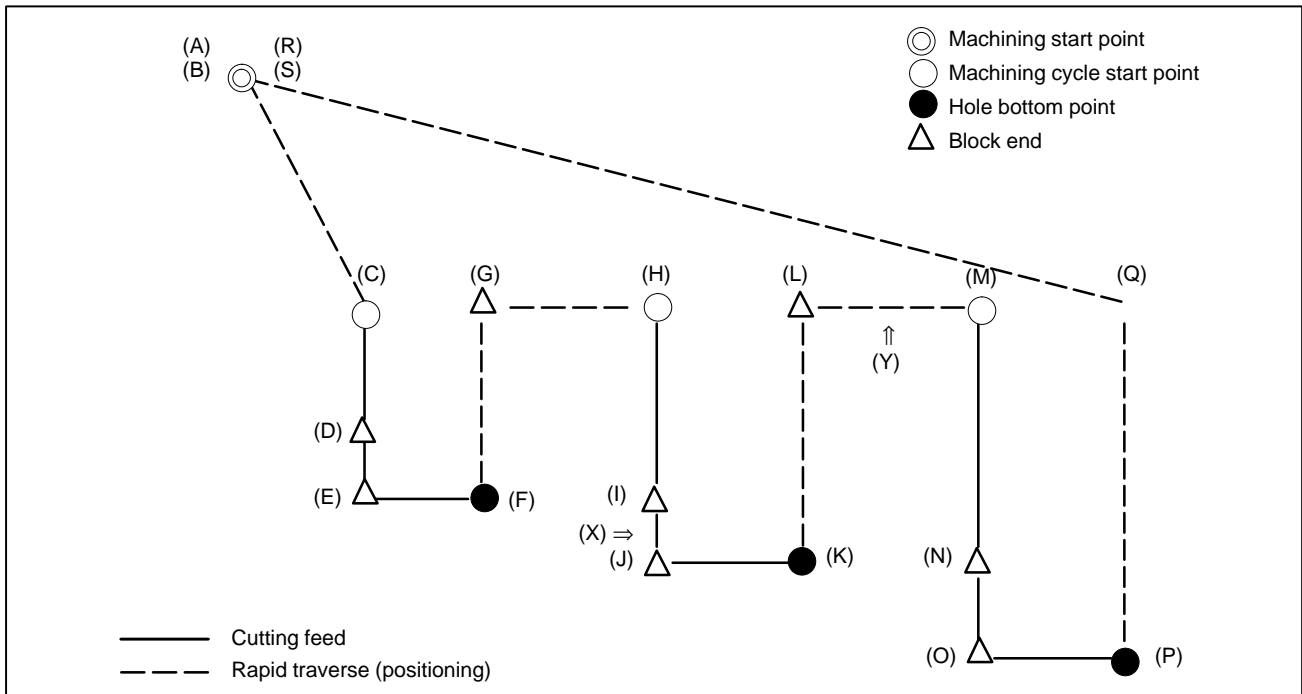
The retreat and retry functions incorporate those functions that are needed to enable retreat and retry operations with a PMC and custom macros. Even if machining is interrupted by a reset or emergency stop, the tool can be returned from the interruption point (retreat function) to restart machining from the start block of the interrupted machining (retry function) easily.

Procedure for Retreat and Retry Functions

The retreat and retry sequences are explained using the sample machining program below.

```

O1000 ;
.....
      G00 X100. Y100. Z100. ;           (A)
N7010 M101 T10 S100 ;                 (B)
      G00 X0. Y0. Z0. ;               (C)
N8010 G01 Z- 20. F100 ;               (D)
      Z- 40. ;                         (E)
      Y20. ;                           (F)
N9010 G00 Z0. ;                       (G)
      X20. ;                           (H)
N8020 G01 Z- 40. F200 ;               (I)
      Z- 60. ;                         (J)
      Y40. ;                           (K)
N9020 G00 Z0. ;                       (L)
      X40. ;                           (M)
N8030 G01 Z- 80. F300 ;               (N)
      Z- 100. ;                       (O)
      Y60. ;                           (P)
N9030 G00 Z0. ;                       (Q)
      X100. Y100. Z100. ;           (R)
N7020 M102 T11 S200 ;                 (S)
.....
(T)
    
```



Procedure 1 Machining retreat program


If a machining cycle being executed is interrupted by a reset or emergency stop at (X), the retreat program is called and executed with a workpiece number search or program number search capability. For information about the workpiece number search and program number search capabilities, refer to the relevant manual published by the machine tool builder. In the retreat program, specify a return operation by referencing stored macro variables as required.

The start point of block (B) of N7010 is stored as the machining start point in a macro variable, and the start point of block (I) of N8020 is stored as the machining cycle start point in a macro variable.

M101 in block (B) of N7010 is stored as the machining type M code in a macro variable. By using this macro variable, a machining cycle can be determined so that the return cycle operation matching the machining cycle can be performed. For rigid tapping, a G code for rigid tapping return specification is available.

Procedure 2 Restart of machining from the machining start point

If a machining cycle being executed is interrupted by a reset or emergency stop at (X), machining can be restarted at machining start point (B) after starting the machining retreat program. In this case, use the following sequence:


1. Return the tool to machining start point (B) with the retreat program.
2. Press the  key.
3. Select the restart of machining at the machining start point with the machining restart point select switch.
4. Set the program restart switch to on.
5. Set the machining restart switch to on.

Thus, search operation is performed by virtually executing the programs from the start of program number 1000 to machining start sequence number 7010 stored in macro variables. Upon completion of search operation, the machining retry completion lamp is turned on.

Then, by pressing the cycle start button, machining is restarted from block (B).

Procedure 3 Retry of machining from a machining cycle start point A

If a machining cycle being executed is interrupted by a reset or emergency stop at (X), machining can be restarted at machining cycle start point (H) after starting the machining retreat program. In this case, use the following sequence:

1. Return the tool to machining cycle start point (H) with the retreat program.
2. Press the  key.
3. Select the restart of machining at the machining cycle start point with the machining restart point select switch.
4. Set the program restart switch to on.
5. Set the machining restart switch to on.

Thus, search operation is performed by virtually executing the programs from the start of program number 1000 to machining cycle start sequence number 8020 stored in macro variables. Upon completion of search operation, the machining restart completion lamp is turned on.

Then, by pressing the cycle start button, machining is restarted from block (I).

Procedure 4 Restart of machining from a machining cycle start point B

If a machining cycle being executed is interrupted by a reset or emergency stop at (Y), machining can be restarted at the machining cycle start point after starting the machining retreat program. In this case, the restart sequence is the same as “restart of machining from a machining cycle restart point (A),” except that the restart sequence number is 8030, and machining is restarted at block (N) because the hole bottom reach flag is set in a macro variable.


Limitations

The following requirements must be satisfied to restart machining:

1. MEM mode is set.
2. The reset state is set.
3. Background editing is not performed.
4. Data required for machining cycles is stored in macro variables.
5. The notes for program restart operation must be observed.

(See III-4.5)

5 TEST OPERATION



The following functions are used to check before actual machining whether the machine operates as specified by the created program.

5.1 Machine Lock and Auxiliary Function Lock

5.2 Feedrate Override

5.3 Rapid Traverse Override

5.4 Dry Run

5.5 Single Block

5.1 MACHINE LOCK AND AUXILIARY FUNCTION LOCK

To display the change in the position without moving the tool, use machine lock.

There are two types of machine lock: all-axis machine lock, which stops the movement along all axes, and specified-axis machine lock, which stops the movement along specified axes only. In addition, auxiliary function lock, which disables M, S, and T commands, is available for checking a program together with machine lock.

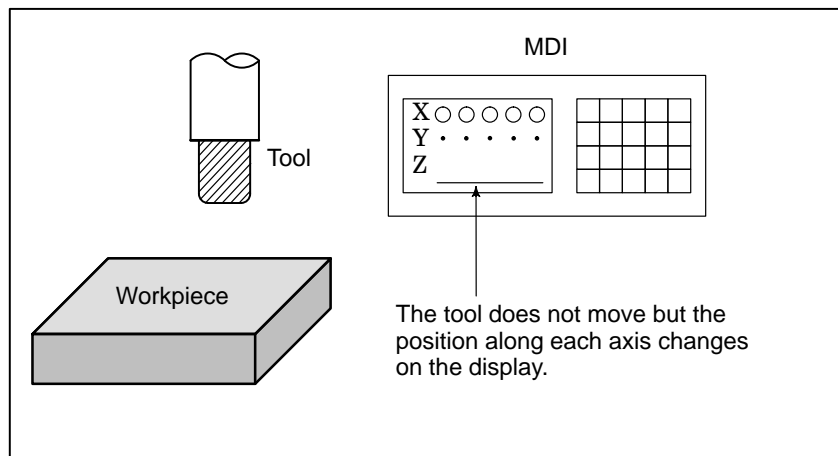


Fig. 5.1 Machine lock

Procedure for Machine Lock and Auxiliary Function Lock

• Machine Lock

Press the machine lock switch on the operator's panel. The tool does not move but the position along each axis changes on the display as if the tool were moving.

Some machines have a machine lock switch for each axis. On such machines, press the machine lock switches for the axes along which the tool is to be stopped. Refer to the appropriate manual provided by the machine tool builder for machine lock.

WARNING

The positional relationship between the workpiece coordinates and machine coordinates may differ before and after automatic operation using machine lock. In such a case, specify the workpiece coordinate system by using a coordinate setting command or by performing manual reference position return.

• Auxiliary Function Lock

Press the auxiliary function lock switch on the operator's panel. M, S, T and B codes are disabled and not executed. Refer to the appropriate manual provided by the machine tool builder for auxiliary function lock.

Restrictions

- **M, S, T, B command by only machine lock**
M, S, T and B commands are executed in the machine lock state.
- **Reference position return under Machine Lock**
When a G27, G28, or G30 command is issued in the machine lock state, the command is accepted but the tool does not move to the reference position and the reference position return LED does not go on.
- **M codes not locked by auxiliary function lock**
M00, M01, M02, M30, M98, and M99 commands are executed even in the auxiliary function lock state. M codes for calling a subprogram (parameters No. 6071 to 6079) and those for calling a custom macro (parameter No. 6080 to 6089) are also executed.

5.2 FEEDRATE OVERRIDE

A programmed feedrate can be reduced or increased by a percentage (%) selected by the override dial. This feature is used to check a program. For example, when a feedrate of 100 mm/min is specified in the program, setting the override dial to 50% moves the tool at 50 mm/min.

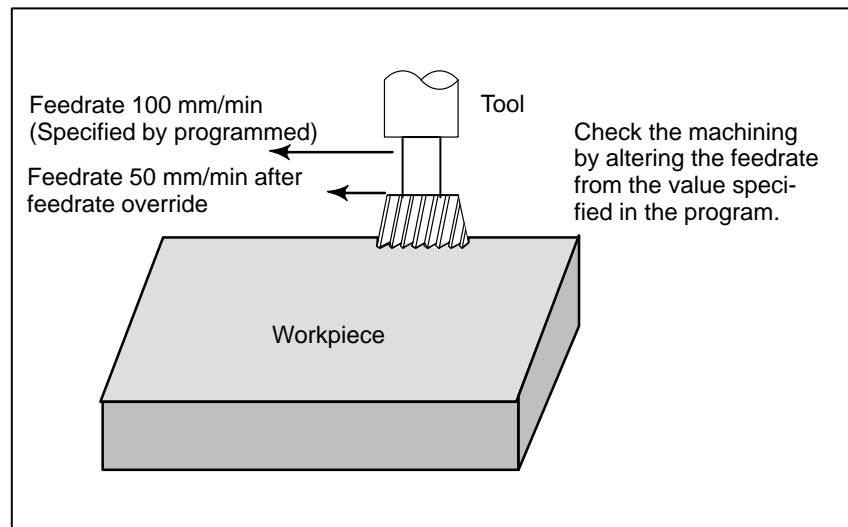
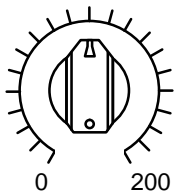


Fig. 5.2 Feedrate override

Procedure for Feedrate Override



JOG FEED RATE OVERRIDE

Set the feedrate override dial to the desired percentage (%) on the machine operator's panel, before or during automatic operation.

On some machines, the same dial is used for the feedrate override dial and jog feedrate dial. Refer to the appropriate manual provided by the machine tool builder for feedrate override.

Restrictions

- **Override Range**

The override that can be specified ranges from 0 to 254%. For individual machines, the range depends on the specifications of the machine tool builder.

- **Override during thread**

During threading, the override is ignored and the feedrate remains as specified by program.

5.3 RAPID TRAVERSE OVERRIDE

An override of four steps (F0, 25%, 50%, and 100%) can be applied to the rapid traverse rate. F0 is set by a parameter (No. 1421).

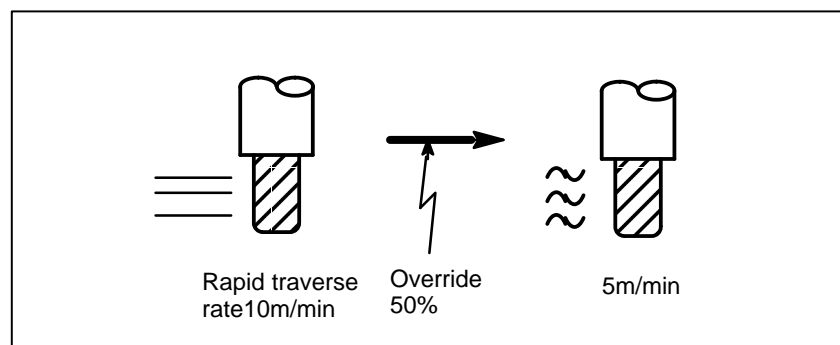
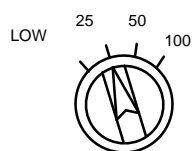


Fig. 5.3 Rapid traverse override

Rapid Traverse Override

Procedure



Rapid traverse override

Select one of the four feedrates with the rapid traverse override switch during rapid traverse. Refer to the appropriate manual provided by the machine tool builder for rapid traverse override.

Explanation

The following types of rapid traverse are available. Rapid traverse override can be applied for each of them.

- 1) Rapid traverse by G00
- 2) Rapid traverse during a canned cycle
- 3) Rapid traverse in G27, G28, G29, G30, G53
- 4) Manual rapid traverse
- 5) Rapid traverse of manual reference position return

5.4 DRY RUN

The tool is moved at the feedrate specified by a parameter regardless of the feedrate specified in the program. This function is used for checking the movement of the tool under the state that the workpiece is removed from the table.

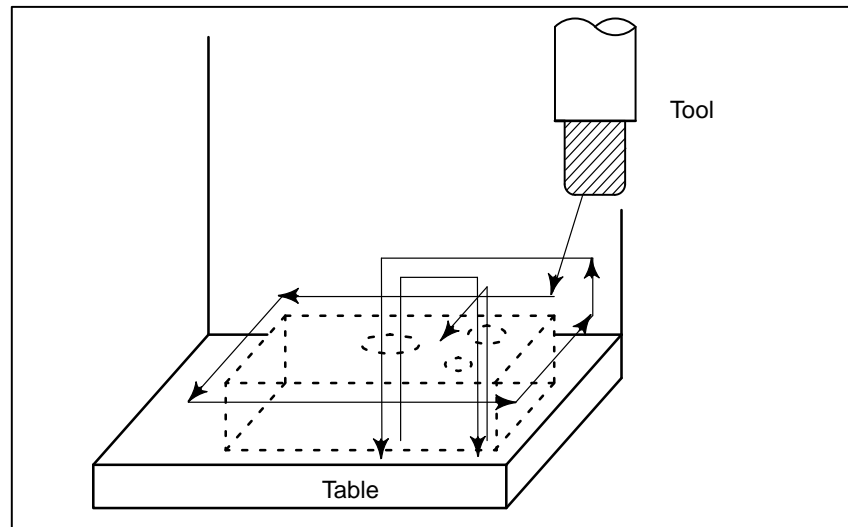


Fig. 5.4 Dry run

Procedure for Dry Run

Procedure

Press the dry run switch on the machine operator's panel during automatic operation.

The tool moves at the feedrate specified in a parameter. The rapid traverse switch can also be used for changing the feedrate.

Refer to the appropriate manual provided by the machine tool builder for dry run.

Explanation

- Dry run feedrate



The dry run feedrate changes as shown in the table below according to the rapid traverse switch and parameters.

Rapid traverse button	Program command	
	Rapid traverse	Feed
ON	Rapid traverse rate	Dry run feedrate × Max.JV *2)
OFF	Dry run speed × JV, or rapid traverse rate *1)	Dry run feedrate × JV *2)

Max. cutting feedrate Setting by parameter No.1422

Rapid traverse rate Setting by parameter No.1420

Dry run feedrate Setting by parameter No.1410

JV: Jog feedrate override

*1) Dry run feedrate x JV when parameter RDR (bit 6 of No. 1401) is 1. Rapid traverse rate when parameter RDR is 0.

*2) Clamped to the maximum cutting feedrate

JVmax: Maximum value of jog feedrate override

5.5 SINGLE BLOCK

Pressing the single block switch starts the single block mode. When the cycle start button is pressed in the single block mode, the tool stops after a single block in the program is executed. Check the program in the single block mode by executing the program block by block.

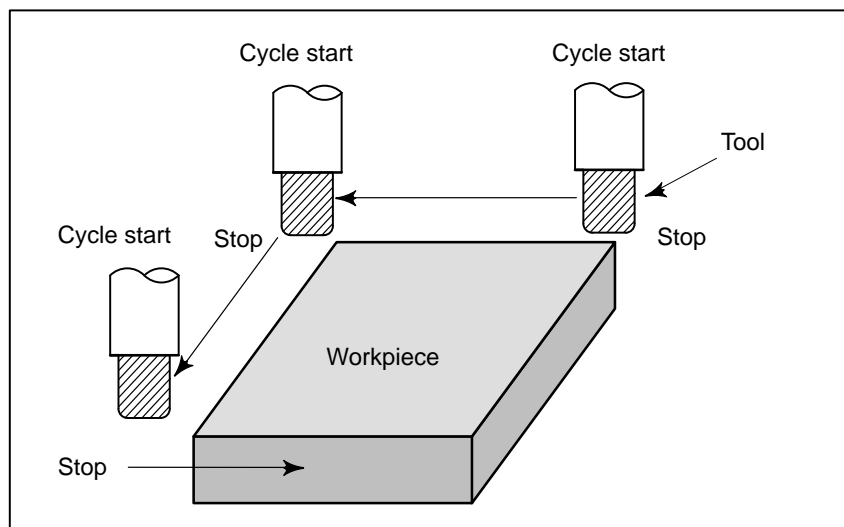


Fig. 5.5 (b) Single block

Procedure for Single block

Procedure

- 1 Press the single block switch on the machine operator's panel. The execution of the program is stopped after the current block is executed.
- 2 Press the cycle start button to execute the next block. The tool stops after the block is executed.

Refer to the appropriate manual provided by the machine tool builder for single block execution.

Explanation

- **Reference position return and single block**

If G28 to G30 are issued, the single block function is effective at the intermediate point.

- **Single block during a canned cycle**

In a canned cycle, the single block stop points are the end of [1], [2], and [6] shown below. When the single block stop is made after the point [1] or [2], the feed hold LED lights.

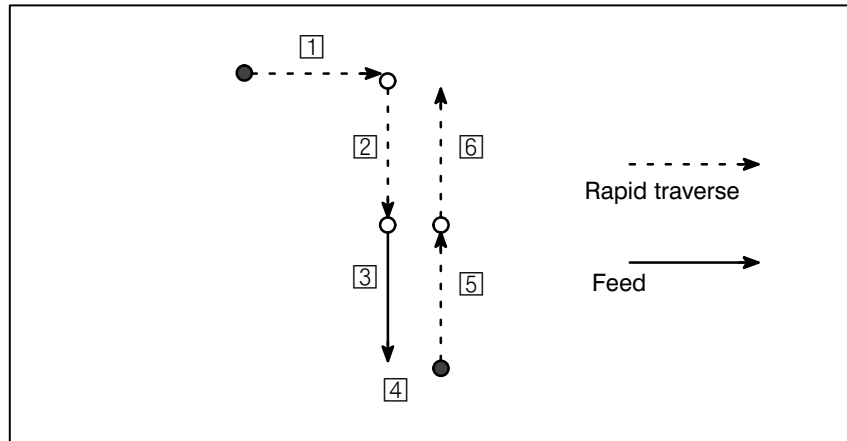


Fig. 5.5 (b) Single block during canned cycle

- **Subprogram call and single block**

Single block stop is not performed in a block containing M98P_; M99; or G65.

However, single block stop is even performed in a block with M98P_ or M99 command, if the block contains an address other than O, N, P, L.

6 SAFETY FUNCTIONS



To immediately stop the machine for safety, press the Emergency stop button. To prevent the tool from exceeding the stroke ends, Overtravel check and Stroke check are available. This chapter describes emergency stop., overtravel check, and stroke check.

6.1 EMERGENCY STOP

If you press Emergency Stop button on the machine operator's panel, the machine movement stops in a moment.

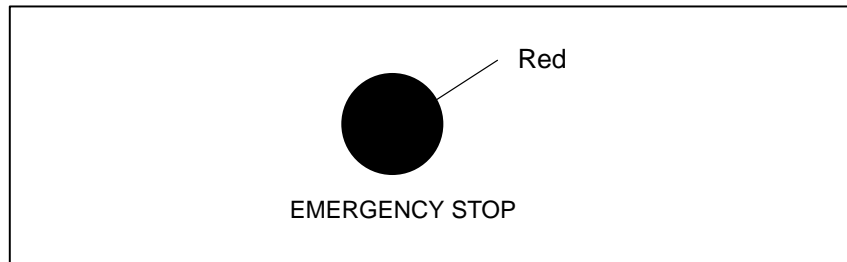


Fig. 6.1 Emergency stop

This button is locked when it is pressed. Although it varies with the machine tool builder, the button can usually be unlocked by twisting it.

Explanation

EMERGENCY STOP interrupts the current to the motor.
Causes of trouble must be removed before the button is released.

6.2 OVERTRAVEL

When the tool tries to move beyond the stroke end set by the machine tool limit switch, the tool decelerates and stops because of working the limit switch and an OVER TRAVEL is displayed.

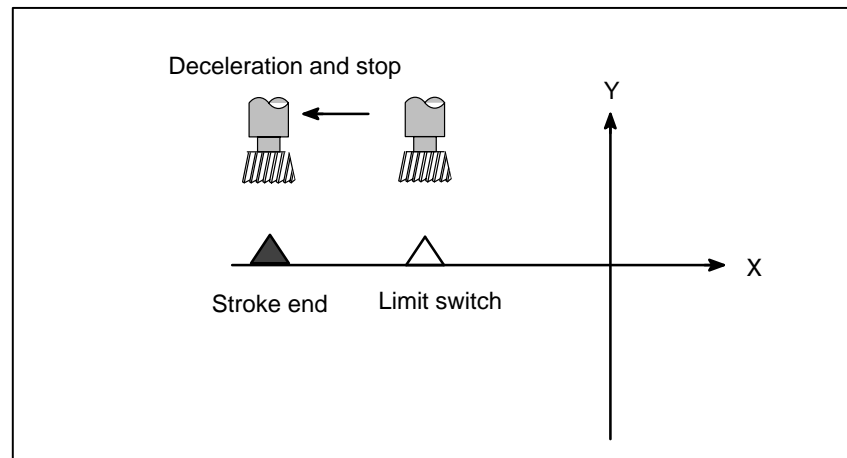


Fig. 6.2 Overtravel

Explanation

- **Overtravel during automatic operation**
- **Overtravel during manual operation**
- **Releasing overtravel**

When the tool touches a limit switch along an axis during automatic operation, the tool is decelerated and stopped along all axes and an overtravel alarm is displayed.

In manual operation, the tool is decelerated and stopped only along the axis for which the tool has touched a limit switch. The tool still moves along the other axes.

Press the reset button to reset the alarm after moving the tool to the safety direction by manual operation. For details on operation, refer to the operator's manual of the machine tool builder.

Alarm

Alarm No.	Message	Description
506	Overtravel: +n	The tool has exceeded the hardware-specified overtravel limit along the positive nth axis (n: 1 to 8).
507	Overtravel: -n	The tool has exceeded the hardware-specified overtravel limit along the negative nth axis (n: 1 to 8).

6.3 STROKE CHECK

Three areas which the tool cannot enter can be specified with stored stroke check 1, stored stroke check 2, and stored stroke check 3.

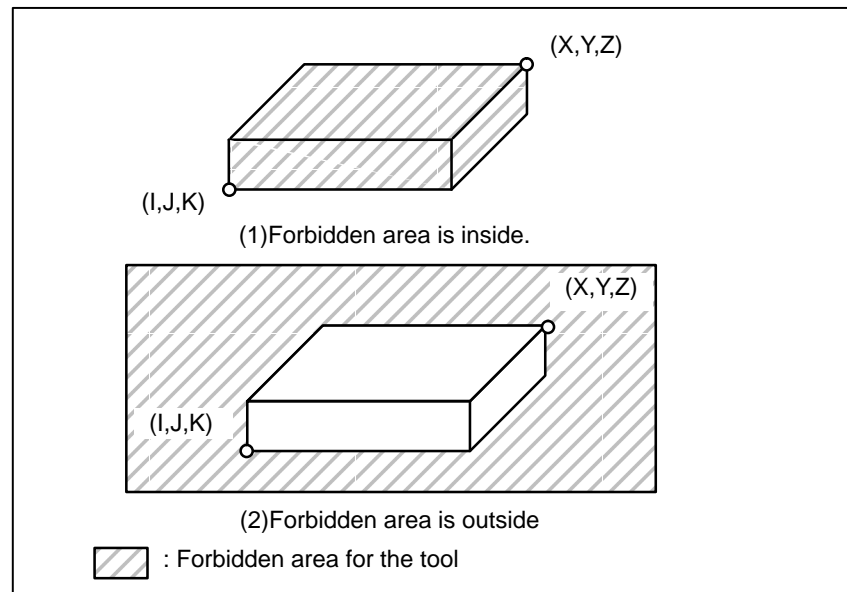


Fig. 6.3 (a) Stroke check

When the tool exceeds a stored stroke limit, an alarm is displayed and the tool is decelerated and stopped.

When the tool enters a forbidden area and an alarm is generated, the tool can be moved in the reverse direction from which the tool came.

Explanation

- **Stored stroke check 1**
- **Stored stroke check 2 (G22, G23)**

Parameters (Nos. 1320, 1321 or Nos. 1326, 1327) set boundary. Outside the area of the set limits is a forbidden area. The machine tool builder usually sets this area as the maximum stroke.

Parameters (Nos. 1322, 1323) or commands set these boundaries. Inside or outside the area of the limit can be set as the forbidden area. Parameter OUT (No. 1300#0) selects either inside or outside as the forbidden area.

In case of program command a G22 command forbids the tool to enter the forbidden area, and a G23 command permits the tool to enter the forbidden area. Each of G22; and G23; should be commanded independently of another commands in a block.

The command below creates or changes the forbidden area:

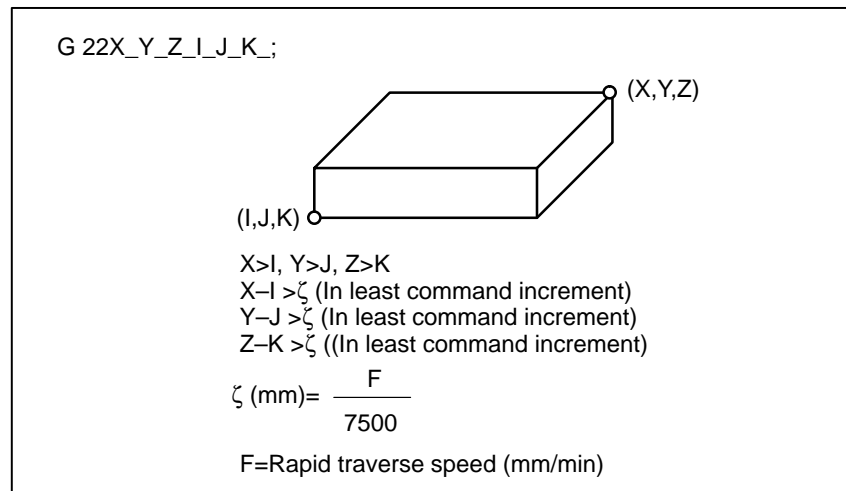


Fig. 6.3(b) Creating or changing the forbidden area using a program

When setting the area by parameters, points A and B in the figure below must be set.

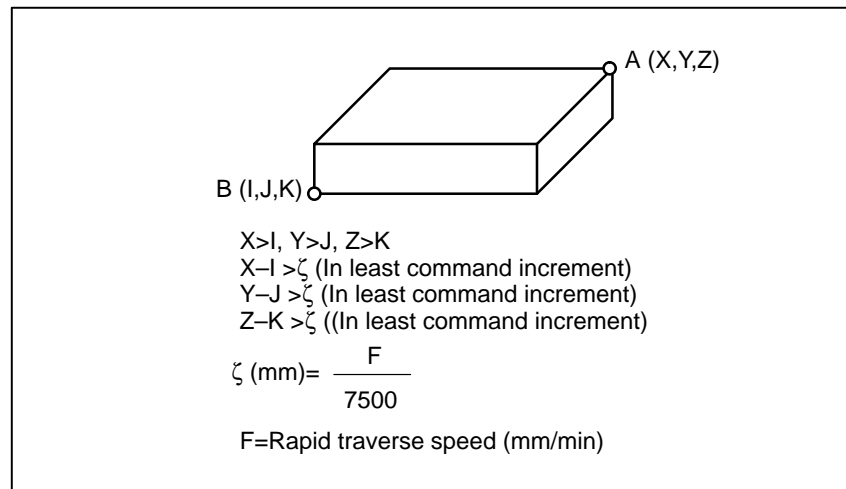


Fig. 6.3 (c) Creating or changing the forbidden area using a parameters

In stored stroke check 2, even if you mistake the order of the coordinate value of the two points, a rectangular, with the two points being the apexes, will be set as the area.

When you set the forbidden area through parameters (Nos. 1322, 1323), the data should be specified by the distance from the machine coordinate system in the least command increment. (Output increment)

If it is set by a G22 command, specify the data by the distance from the machine coordinate system in the least input increment (Input increment.)

The programmed data are then converted into the numerical values in the least command increment, and the values are set as the parameters.

- **Stored stroke check 3**

Set the boundary with parameters No. 1324 and 1325. The area inside the boundary becomes the forbidden area.

- **Checkpoint for the forbidden area**

Confirm the checking position (the top of the tool or the tool chuck) before programming the forbidden area.

If point A (The top of the tool) is checked in Fig. 6.3 (d) , the distance “a” should be set as the data for the stored stroke limit function. If point B (The tool chuck) is checked, the distance “b” must be set. When checking the tool tip (like point A), and if the tool length varies for each tool, setting the forbidden area for the longest tool requires no re-setting and results in safe operation.

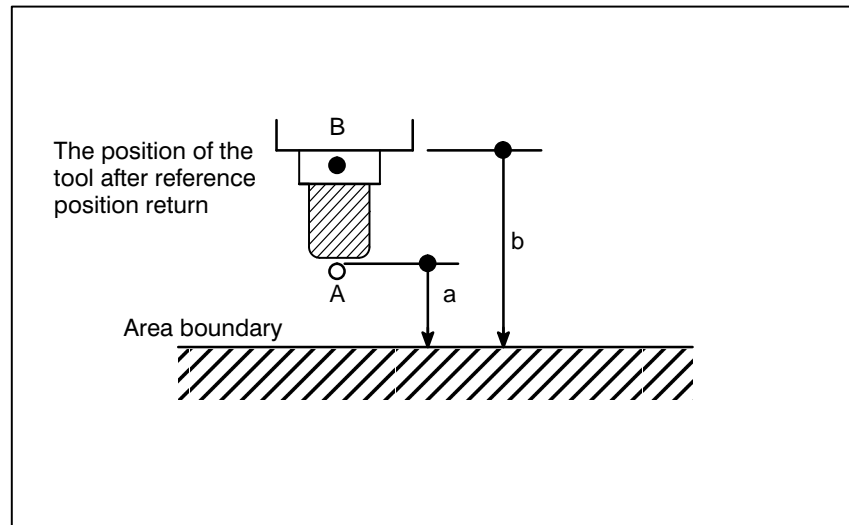


Fig. 6.3 (d) Setting the forbidden area

- **Forbidden area over lapping**

Area can be set in piles.

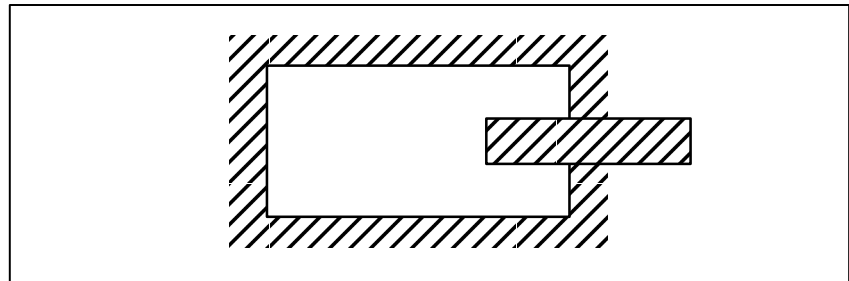


Fig. 6.3 (e) Setting the forbidden area over lapping

Unnecessary limits should be set beyond the machine stroke.

- **Overrun amount of stored stroke limit**

If the maximum rapid traverse rate is F (mm/min), the maximum overrun amount, L (mm), of the stored stroke limit is obtained from the following expression:

$$L \text{ (mm)} = F/7500$$

The tool enters the specified inhibited area by up to L (mm). Bit 7 (BFA) of parameter No. 1300 can be used to stop the tool when it reaches a point L mm short of the specified area. In this case, the tool will not enter the inhibited area.

- **Effective time for a forbidden area**

Each limit becomes effective after the power is turned on and manual reference position return or automatic reference position return by G28 has been performed.

After the power is turned on, if the reference position is in the forbidden area of each limit, an alarm is generated immediately. (Only in G22 mode for stored stroke limit 2).

- **Releasing the alarms**
If the tool enters a forbidden area and an alarm is generated, the tool can be moved only in the backward direction. To cancel the alarm, move the tool backward until it is outside the forbidden area and reset the system. When the alarm is canceled, the tool can be moved both backward and forward.
- **Change from G23 to G22 in a forbidden area**
When G23 is switched to G22 in the forbidden area, the following results.
(1) When the forbidden area is inside, an alarm is informed in the next move.
(2) When the forbidden area is outside, an alarm is informed immediately.
- **Timing for displaying an alarm**
Parameter BFA (bit 7 of No. 1300) selects whether an alarm is displayed immediately before the tool enters the forbidden area or immediately after the tool has entered the forbidden area.
- **Setting a forbidden area for two-path control**
For two-path control, set a forbidden area for each path.

NOTE

In setting a forbidden area, if the two points to be set are the same, the area is as follows:

- (1) When the forbidden area is stored stroke check 1, all areas are forbidden areas.
- (2) When the forbidden area is stored stroke check 2 or stored stroke check 3, all areas are movable areas.

Alarms

Alarm Number	Message	Contents
500	OVER TRAVEL: +n	Exceeded the n-th axis (1-8) + side stored stroke limit I.
501	OVER TRAVEL: -n	Exceeded the n-th axis (1-8) - side stored stroke limit I.
502	OVER TRAVEL: +n	Exceeded the n-th axis (1-8) + side stored stroke limit II.
503	OVER TRAVEL: -n	Exceeded the n-th axis (1-8) - side stored stroke limit II.
504	OVER TRAVEL: +n	Exceeded the n-th axis (1-8) + side stored stroke limit III.
505	OVER TRAVEL: -n	Exceeded the n-th axis (1-8) - side stored stroke limit III.

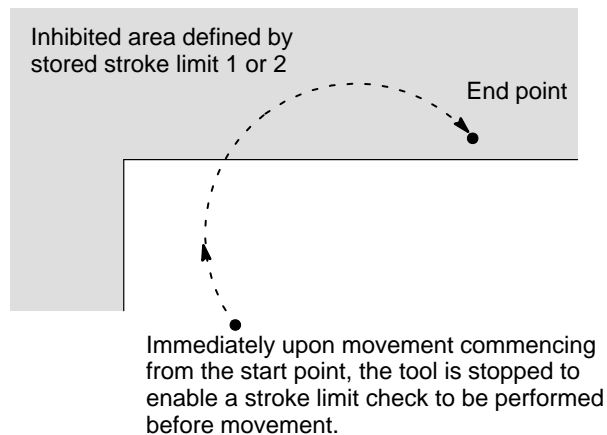
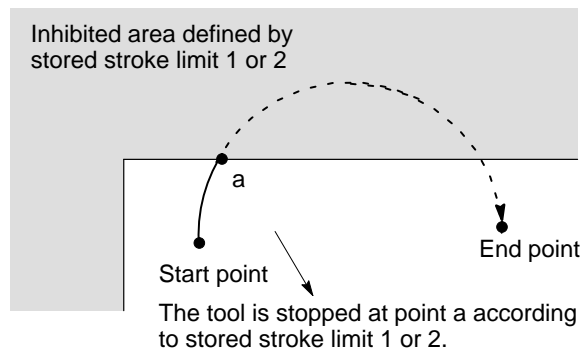
6.4 STROKE LIMIT CHECK PRIOR TO PERFORMING MOVEMENT

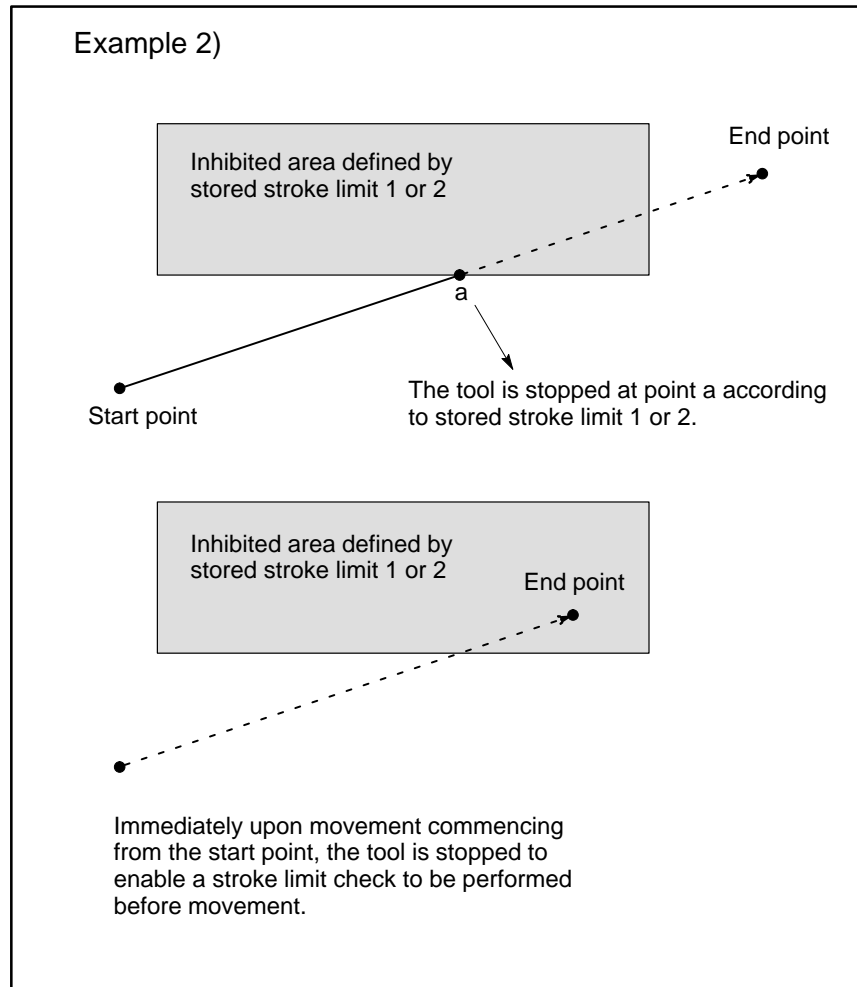
During automatic operation, before the movement specified by a given block is started, whether the tool enters the inhibited area defined by stored stroke limit 1, 2, or 3 is checked by determining the position of the end point from the current position of the machine and a specified amount of travel. If the tool is found to enter the inhibited area defined by a stored stroke limit, the tool is stopped immediately upon the start of movement for that block, and an alarm is displayed.

WARNING

Whether the coordinates of the end point, reached as a result of traversing the distance specified in each block, are in a inhibited area is checked. In this case, the path followed by a move command is not checked. However, if the tool enters the inhibited area defined by stored stroke limit 1, 2, or 3, an alarm is issued. (See the examples below.)

Example 1)





Explanations

When a stroke limit check prior to movement is performed, whether to check the movement performed by a G31 (skip) block and G37 (automatic tool length measurement) block can be determined using NPC (bit 2 of parameter No. 1301).

Limitations

- **Machine lock**

If machine lock is applied at the start of movement, no stroke limit check made before movement is performed.

- **G23**

When stored stroke limit 2 is disabled (G23 mode), no check is made to determine whether the tool enters the inhibited area defined by stored stroke limit 2.

- **Program restart**

When a program is restarted, an alarm is issued if the restart position is within a inhibited area.

- **Manual intervention following a feed hold stop**

When the execution of a block is restarted after manual intervention following a feed hold stop, no alarm is issued even if the end point following a manual intervention is within a inhibited area.

- **A block consisting of multiple operations**

If a block consisting of multiple operations (such as a canned cycle and exponential interpolation) is executed, an alarm is issued at the start point of any operation whose end point falls within a inhibited area.

- **Cyrindrical interpolation mode** In cylindrical interpolation mode, no check is made.
- **Polar coordinate interpolation mode** In polar coordinate interpolation mode, no check is made.
- **Angular axis control** When the angular axis control option is selected, no check is made.
- **Simple synchronous control** In simple synchronous control, only the master axis is checked; no slave axes are checked.
- **Three-dimensional coordinate conversion** In three-dimensional coordinate conversion mode, no check is made.
- **Drawing** No check is performed while drawing is being performed as part of dynamic graphic display (only drawing (no machining) is being performed).
- **PMC axis control** No check is made for a movement based on PMC axis control.
- **High-speed high-precision contour control (HPCC)** No check is made for a movement based on high-speed, high-precision contour control (HPCC).

Alarm

Number	Message	Contents
510	OVER TRAVEL : +n	The pre-movement stroke limit check reveals that the block end point enters the prohibited area for the positive stroke limit along the n axis. Correct the program.
511	OVER TRAVEL : -n	The pre-movement stroke limit check reveals that the block end point enters the prohibited area for the negative stroke limit along the n axis. Correct the program.

7 ALARM AND SELF-DIAGNOSIS FUNCTIONS

When an alarm occurs, the corresponding alarm screen appears to indicate the cause of the alarm. The causes of alarms are classified by error codes. Up to 25 previous alarms can be stored and displayed on the screen (alarm history display).

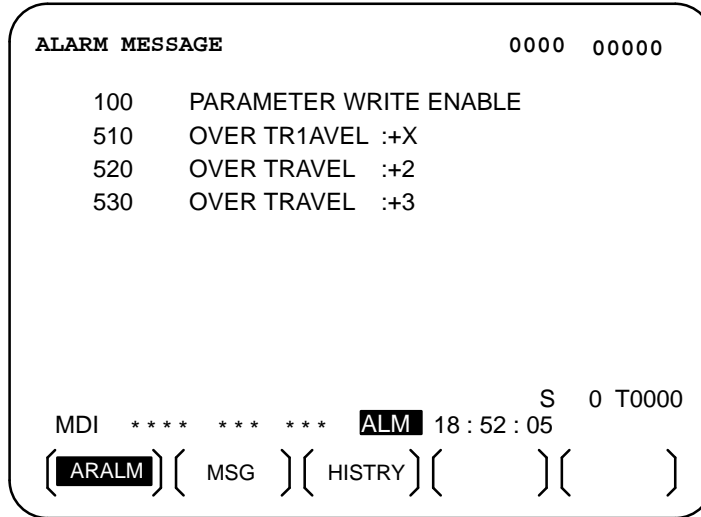
The system may sometimes seem to be at a halt, although no alarm is displayed. In this case, the system may be performing some processing. The state of the system can be checked using the self-diagnostic function.

7.1 ALARM DISPLAY

Explanations

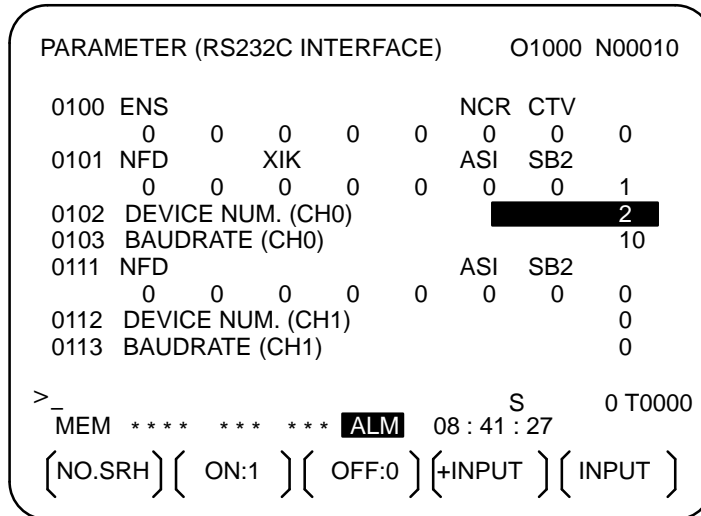
- Alarm screen

When an alarm occurs, the alarm screen appears.




- Another method for alarm displays

In some cases, the alarm screen does not appear, but an ALM is displayed at the bottom of the screen.



In this case, display the alarm screen as follows:

1. Press the function key  .
2. Press the chapter selection soft key **[ALARM]**.

- **Reset of the alarm**

Error codes and messages indicate the cause of an alarm. To recover from an alarm, eliminate the cause and press the reset key.

- **Error codes**

The error codes are classified as follows:

No. 000 to 255 : P/S alarm (Program errors) (*)

No. 300 to 349 : Absolute pulse coder (APC) alarms

No. 350 and 399 : Serial pulse coder (SPC) alarms

No. 400 to 499 : Servo alarms

No. 500 to 599 : Overtravel alarms

No. 700 to 749 : Overheat alarms

No. 750 to 799 : Spindle alarms

No. 900 to 999 : System alarms

No. 5000 to : P/S alarm (Program errors)

* For an alarm (No. 000 to 255) that occurs in association with background operation, the indication “xxxBP/S alarm” is provided (where xxx is an alarm number). Only a BP/S alarm is provided for No. 140.

See the error code list in the appendix for details of the error codes.


7.2 ALARM HISTORY DISPLAY

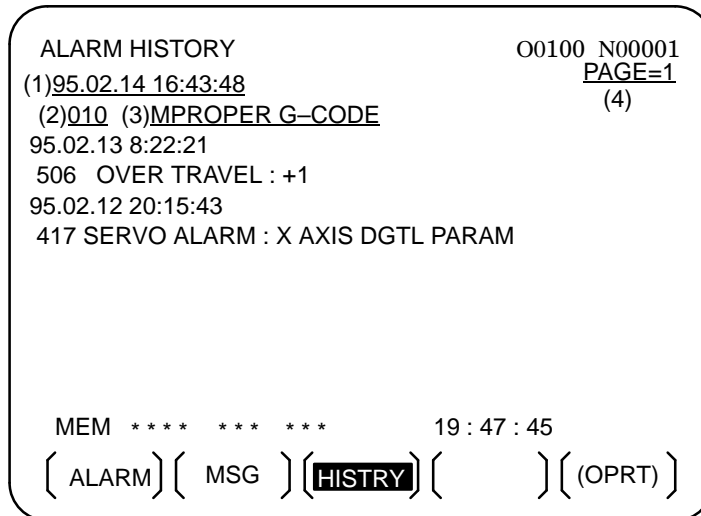
Up to 25 of the most recent CNC alarms are stored and displayed on the screen.

Display the alarm history as follows:

Procedure for Alarm History Display

Procedure

- 1 Press the function key  .
- 2 Press the chapter selection soft key **[HISTRY]**.
The alarm history appears.
The following information items are displayed.
 - (1)The date the alarm was issued
 - (2)Alarm No.
 - (3)Alarm message (some contains no message)
- 3 Change the page by the 1–page change key.
- 4 To delete the recorded information, press the softkey **[(OPRT)]** then the **[DELETE]** key.




- (1) The date the alarm was issued
- (2) Alarm No.
- (3) Alarm message (some contains no message)
- (4) Page No.

7.3 CHECKING BY SELF-DIAGNOSTIC SCREEN

The system may sometimes seem to be at a halt, although no alarm has occurred. In this case, the system may be performing some processing. The state of the system can be checked by displaying the self-diagnostic screen.

Procedure for Diagnosis

Procedure

- 1 Press the function key  .
- 2 Press the chapter select key **[DGNOS]**.
- 3 The diagnostic screen has more than 1 pages. Select the screen by the following operation.
 - (1) Change the page by the 1-page change key.
 - (2) Method by soft key
 - Key input the number of the diagnostic data to be displayed.
 - Press **[N SRCH]**.

```

DIAGNOSTIC (GENERAL)                O0000 N0000

000  WAITING FOR FIN SIGNAL          :0
001  MOTION                          :0
002  DWELL                           :0
003  IN-POSITION CHECK               :0
004  FEEDRATE OVERRIDE 0%           :0
005  INTERLOCK/START-LOCK           :0
006  SPINDLE SPEED ARRIVAL CHECK    :0

>_
EDIT ***** ** * 14:51:55
( PARAM ) ( DGNOS ) ( PMC ) ( SYSTEM ) ( OPRT )

```

Explanations

- **Self diagnostic screen at 2-path control**

For the two-path control, the diagnostic screen for the tool post selected with the tool post selection switch is displayed. When displaying the diagnostic screen for the other tool post, specify the tool post with the tool post selection switch.

Explanations

Diagnostic numbers 000 to 015 indicate states when a command is being specified but appears as if it were not being executed. The table below lists the internal states when 1 is displayed at the right end of each line on the screen.

Table 7.3 (a) Alarm displays when a command is specified but appears as if it were not being executed

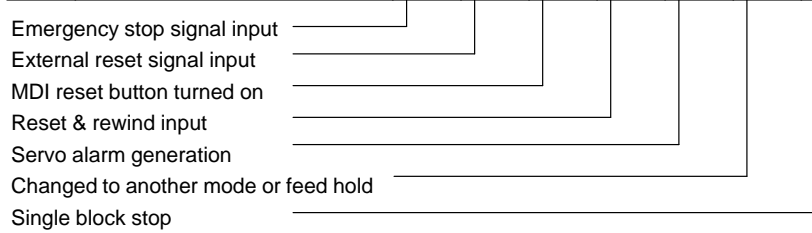
No.	Display	Internal status when 1 is displayed
000	WAITING FOR FIN SIGNAL	M, S, T function being executed
001	MOTION	Move command in automatic operation being executed
002	DWELL	Dwell being executed
003	IN-POSITION CHECK	In-position check being executed
004	FEEDRATE OVERRIDE 0%	Cutting feed override 0%
005	INTERLOCK/START-LOCK	Interlock ON
006	SPINDLE SPEED ARRIVAL CHECK	Waiting for spindle speed arrival signal to turn on
010	PUNCHING	Data being output via reader puncher interface
011	READING	Data being input via reader puncher interface
012	WAITING FOR (UN) CLAMP	Waiting for index table clamp/unclamp before B axis index table indexing start/after B axis index table indexing end to complete
013	JOG FEEDRATE OVERRIDE 0%	Jog override 0%
014	WAITING FOR RESET.ESP.RRW.OFF	Emergency stop, external reset, reset & rewind, or MDI panel reset key on
015	EXTERNAL PROGRAM NUMBER SEARCH	External program number searching

Table 7.3 (b) Alarm displays when an automatic operation is stopped or paused.

No.	Display	Internal status when 1 is displayed
020	CUT SPEED UP/DOWN	Set when emergency stop turns on or when servo alarm occurs
021	RESET BUTTON ON	Set when reset key turns on
022	RESET AND REWIND ON	Reset and rewind turned on
023	EMERGENCY STOP ON	Set when emergency stop turns on
024	RESET ON	Set when external reset, emergency stop, reset, or reset & rewind key turns on
025	STOP MOTION OR DWELL	A flag which stops pulse distribution. It is set in the following cases. (1) External reset turned on. (2) Reset & rewind turned on. (3) Emergency stop turned on. (4) Feed hold turned on. (5) The MDI panel reset key turned on. (6) Switched to the manual mode(JOG/HANDLE/INC). (7) Other alarm occurred. (There is also alarm which is not set.)

The table below shows the signals and states which are enabled when each diagnostic data item is 1. Each combination of the values of the diagnostic data indicates a unique state.

020	CUT SPEED UP/DOWN	1	0	0	0	1	0	0
021	RESET BUTTON ON	0	0	1	0	0	0	0
022	RESET AND REWIND ON	0	0	0	0	0	0	0
023	EMERGENCY STOP ON	1	0	0	0	0	0	0
024	RESET ON	1	1	1	1	0	0	0
025	STOP MOTION OR DWELL	1	1	1	1	1	1	0



Diagnostic numbers 030 and 031 indicate TH alarm states.

No.	Display	Meaning of data
030	CHARACTER NUMBER TH DATA	The position of the character which caused TH alarm is displayed by the number of characters from the beginning of the block at TH alarm
031	TH DATA	Read code of character which caused TH alarm

8

DATA INPUT/OUTPUT

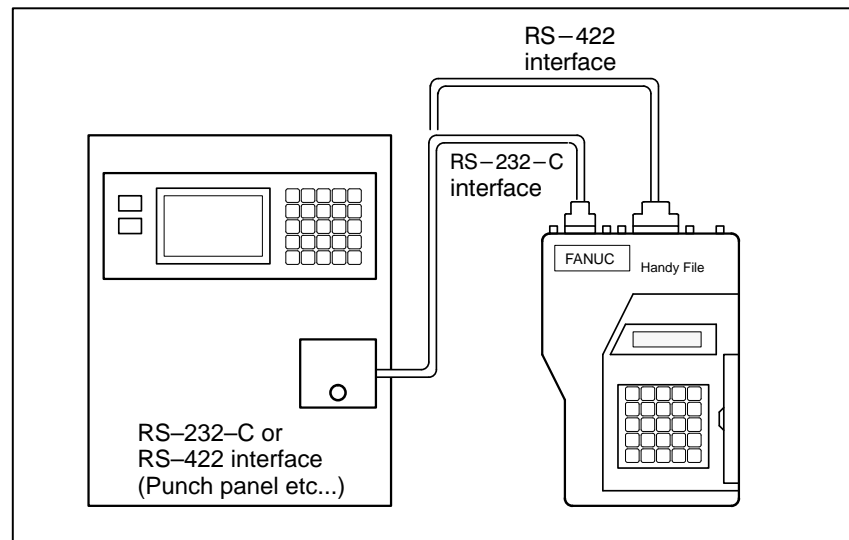
NC data is transferred between the NC and external input/output devices such as the Handy File.

The following types of data can be entered and output :

- 1.Program
- 2.Offset data
- 3.Parameter
- 4.Pitch error compensation data
- 5.Custom macro common variable

Before an input/output device can be used, the input/output related parameters must be set.

For how to set parameters, see III-2 “**OPERATIONAL DEVICES**”.



8.1 FILES

Of the external input/output devices, the FANUC Handy File and FANUC Floppy Cassette use floppy disks as their input/output medium, and the FANUC FA Card uses an FA card as its input/output medium.

In this manual, these input/output medium is generally referred to as a floppy. However, when the description of one input/output medium varies from the description of another, the name of the input/output medium is used. In the text below, a floppy represents a floppy disk or FA card.

Unlike an NC tape, a floppy allows the user to freely choose from several types of data stored on one medium on a file-by-file basis.

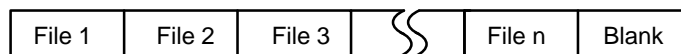
Input/output is possible with data extending over more than one floppy disk.

Explanations

- **What is a File**

The unit of data, which is input/output between the floppy and the CNC by one input/output operation (pressing the VREADW or VPUNCHW key), is called a HfileI. When inputting CNC programs from, or outputting them to the floppy, for example, one or all programs within the CNC memory are handled as one file.

Files are assigned automatically file numbers 1,2,3,4 and so on, with the lead file as 1.

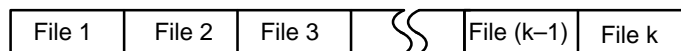


- **Request for floppy replacement**

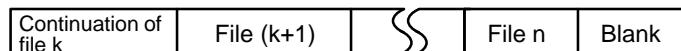
When one file has been entered over two floppies, LEDs on the adaptor flash alternately on completion of data input/output between the first floppy and the CNC, prompting floppy replacement. In this case, take the first floppy out of the adaptor and insert a second floppy in its place. Then, data input/output will continue automatically.

Floppy replacement is prompted when the second floppy and later is required during file search-out, data input/output between the CNC and the floppy, or file deletion.

Floppy 1



Floppy 2



Since floppy replacement is processed by the input/output device, no special operation is required. The CNC will interrupt data input/output operation until the next floppy is inserted into the adaptor.

When reset operation is applied to the CNC during a request for floppy replacement, the CNC is not reset at once, but reset after the floppy has been replaced.

● **Protect switch**

The floppy is provided with the write protect switch. Set the switch to the write enable state. Then, start output operation.

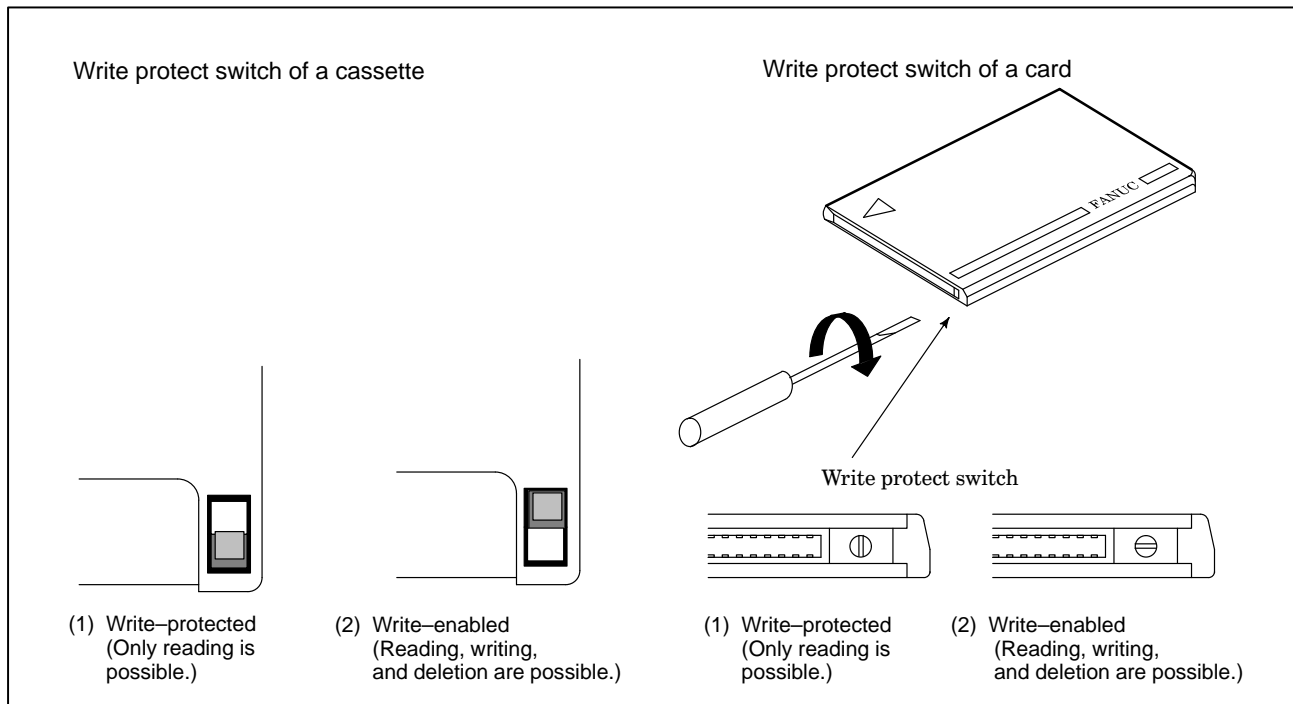


Fig. 8.1. Protect switch

● **Writing memo**

Once written in the cassette or card, data can subsequently be read out by correspondence between the data contents and file numbers. This correspondence cannot be verified, unless the data contents and file numbers are output to the CNC and displayed. The data contents can be displayed with display function for directory of floppy disk (See Section III-8.8).

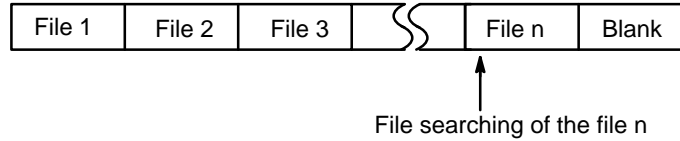
To display the contents, write the file numbers and the contents on the memo column which is the back of floppy.

- (Entry example on MEMO)
- File 1 NC parameters
 - File 2 Offset data
 - File 3 NC program O0100
 - ·
 - ·
 - ·
 - File (n-1) NC program O0500
 - File n NC program O0600

8.2 FILE SEARCH



When the program is input from the floppy, the file to be input first must be searched.

For this purpose, proceed as follows:



File heading

Procedure

- 1 Press the EDIT or MEMORY switch on the machine operator's panel.
- 2 Press function key , then the program contents display screen or program check screen appears.
- 3 Press soft key **[(OPRT)]**.
- 4 Press the rightmost soft key  (next-menu key).
- 5 Enter address N.
- 6 Enter the number of the file to search for.
 - N0
The beginning of the cassette or card is searched.
 - One of N1 to N9999
Of the file Nos. 1 to 9999, a designated file is searched.
 - N-9999
The file next to that accessed just before is searched.
 - N-9998
When N-9998 is designated, N-9999 is automatically inserted each time a file is input or output. This condition is reset by the designation of N1, N1 to 9999, or N-9999 or reset.
- 7 Press soft keys **[F SRH]** and **[EXEC]**.
The specified file is searched for.

Explanation

- **File search by N-9999**

The same result is obtained both by sequentially searching the files by specifying Nos. N1 to N9999 and by first searching one of N1 to N9999 and then using the N-9999 searching method. The searching time is shorter in the latter case.

Alarm



Alarm No.	Description
86	<p>The ready signal (DR) of an input/output device is off.</p> <p>An alarm is not immediately indicated in the CNC even when an alarm occurs during head searching (when a file is not found, or the like).</p> <p>An alarm is given when the input/output operation is performed after that. This alarm is also raised when N1 is specified for writing data to an empty floppy. (In this case, specify No.)</p>

8.3 FILE DELETION

Files stored on a floppy can be deleted file by file as required.

File deletion

Procedure

- 1 Insert the floppy into the input/output device so that it is ready for writing.
- 2 Press the EDIT switch on the machine operator's panel.
- 3 Press function key , then the program contents display screen appears.
- 4 Press soft key **[(OPRT)]**
- 5 Press the rightmost soft key  (next-menu key).
- 6 Enter address N.
- 7 Enter the number (from 1 to 9999) of the file to delete.
- 8 Press soft key **[DELETE]** and then press soft key **[DELETE]**.
The file specified in step 7 is deleted.

Explanations

- **File number after the file is deleted**

When a file is deleted, the file numbers after the deleted file are each decremented by one. Suppose that a file numbered k was deleted. In this case, files are renumbered as follows:

Before deletion	after deletion
1 to (k>1)	1 to (k>1)
k	Deleted
(k+1) to n	k to (n>1)

- **Protect switch**

Set the write protect switch to the write enable state to delete the files.



8.4 PROGRAM INPUT/OUTPUT

8.4.1 Inputting a Program

This section describes how to load a program into the CNC from a floppy or NC tape.

Inputting a program

Procedure

- 1 Make sure the input device is ready for reading.
For the two-path control, select the tool post for which a program to be input is used with the tool post selection switch.
- 2 Press the EDIT switch on the machine operator's panel.
- 3 When using a floppy, search for the required file according to the procedure in **III-8.2**.
- 4 Press function key , then the program contents display screen or program directory screen appears.
- 5 Press soft key **[(OPRT)]**.
- 6 Press the rightmost soft key  (next-menu key).
- 7 After entering address O, specify a program number to be assigned to the program. When no program number is specified here, the program number used on the floppy or NC tape is assigned.
- 8 Press soft keys **[READ]** and **[EXEC]**
The program is input and the program number specified in step 7 is assigned to the program.

Explanations

- **Collation**

If a program is input while the data protect key on the machine operator's panel turns ON, the program loaded into the memory is verified against the contents of the floppy or NC tape.

If a mismatch is found during collation, the collation is terminated with an alarm (P/S No. 079).

If the operation above is performed with the data protection key turns OFF, collation is not performed, but programs are registered in memory.

- **Inputting multiple programs from an NC tape**

When a tape holds multiple programs, the tape is read up to ER (or %).

◀	O1111 M02; - - -	O2222 M30; - - -	O3333 M02; - - -	ER(%)	⋮
---	------------------	------------------	------------------	-------	---

- **Program numbers on a NC tape**

- When a program is entered without specifying a program number.
 - The O-number of the program on the NC tape is assigned to the program.
If the program has no O-number, the N-number in the first block is assigned to the program.
 - When the program has neither an O-number nor N-number, the previous program number is incremented by one and the result is assigned to the program.
 - When the program does not have an O-number but has a five-digit sequence number at the start of the program, the lower four digits of the sequence number are used as the program number. If the lower four digits are zeros, the previously registered program number is incremented by one and the result is assigned to the program.
- When a program is entered with a program number
The O-number on the NC tape is ignored and the specified number is assigned to the program. When the program is followed by additional programs, the first additional program is given the program number. Additional program numbers are calculated by adding one to the last program.

- **Program registration in the background**

The method of registration operation is the same as the method of foreground operation. However, this operation registers a program in the background editing area. As with edit operation, the operations described below are required at the end to register a program in foreground program memory.

[(OPRT)] [BG-END]

- **Additional program input**

You can input a program to be appended to the end of a registered program.

Registered program	Input program	Program after input
○1234 ;	○5678 ;	○1234 ;
□□□□□□ ;	○○○○○○○ ;	□□□□□□ ;
□□□□□ ;	○○○○○ ;	□□□□□ ;
□□□□ ;	○○○○ ;	□□□□ ;
□□□ ;	○○○ ;	□□□ ;
%	%	%
		○5678 ;
		○○○○○○○ ;
		○○○○○ ;
		○○○○ ;
		○○○ ;
		%

In the above example, all lines of program O5678 are appended to the end of program O1234. In this case, program number O5678 is not registered. When inputting a program to be appended to a registered program, press the **[READ]** soft key without specifying a program number in step 8. Then, press the **[CHAIN]** and **[EXEC]** soft keys.

- In entire program input, all lines of a program are appended, except for its O number.
- When canceling additional input mode, press the reset key or the **[CAN]** or **[STOP]** soft key.

- **Defining the same program number as that of an existing program**

- Pressing the [CHAIN] soft key positions the cursor to the end of the registered program. Once a program has been input, the cursor is positioned to the start of the new program.
- Additional input is possible only when a program has already been registered.

If an attempt has been made to register a program having the same number as that of a previously registered program, P/S alarm 073 is issued and the program cannot be registered.

Alarm



Alarm No.	Description
70	The size of memory is not sufficient to store the input programs
73	An attempt was made to store a program with an existing program number.
79	The verification operation found a mismatch between a program loaded into memory and the contents of the program on the floppy or NC tape.

8.4.2 Outputting a Program

A program stored in the memory of the CNC unit is output to a floppy or NC tape.

Outputting a program

Procedure

- 1 Make sure the output device is ready for output.
For the two-path control, select the tool post for which a program to be output is used with the tool post selection switch.
- 2 To output to an NC tape, specify the punch code system (ISO or EIA) using a parameter.
- 3 Press the EDIT switch on the machine operator's panel.
- 4 Press function key , then the program contents display screen or program directory screen appears.
- 5 Press soft key **[(OPRT)]**.
- 6 Press the rightmost soft key  (next-menu key).
- 7 Enter address O.
- 8 Enter a program number. If -9999 is entered, all programs stored in memory are output.
To output multiple programs at one time, enter a range as follows :
OΔΔΔΔ,O□□□□
Programs No.ΔΔΔΔ to No.□□□□ are output.
The program library screen displays program numbers in ascending order when bit 4 (SOR) of parameter No. 3107 is set to 1.
- 9 Press soft keys **[PUNCH]** and **[EXEC]**
The specified program or programs are output.

Explanations (Output to a floppy)

- **File output location**
When output is conducted to the floppy, the program is output as the new file after the files existing in the floppy. New files are to be written from the beginning with making the old files invalid, use the above output operation after the N0 head searching.
- **An alarm while a program is output**
When P/S alarm (No. 86) occurs during program output, the floppy is restored to the condition before the output.
- **Outputting a program after file heading**
When program output is conducted after N1 to N9999 head searching, the new file is output as the designated n-th position. In this case, 1 to n-1 files are effective, but the files after the old n-th one are deleted. If an alarm occurs during output, only the 1 to n-1 files are restored.
- **Efficient use of memory**
To efficiently use the memory in the cassette or card, output the program by setting parameter NFD (No. 0101#7, No. 0111#7 or 0121#7) to 1. This parameter makes the feed is not output, utilizing the memory efficiently.

- **On the memo record**

Head searching with a file No. is necessary when a file output from the CNC to the floppy is again input to the CNC memory or compared with the content of the CNC memory. Therefore, immediately after a file is output from the CNC to the floppy, record the file No. on the memo.

- **Punching programs in the background**

Punch operation can be performed in the same way as in the foreground. This function alone can punch out a program selected for foreground operation.

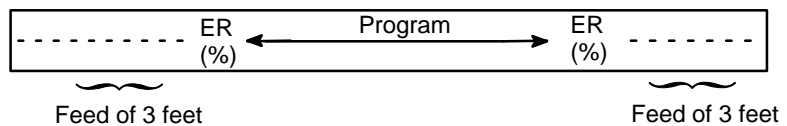
<O> (Program No.) **[PUNCH] [EXEC]**: Punches out a specified program.

<O> H-9999I **[PUNCH] [EXEC]**: Punches out all programs.

**Explanations
(Output to an NC tape)**

- **Format**

A program is output to paper tape in the following format:



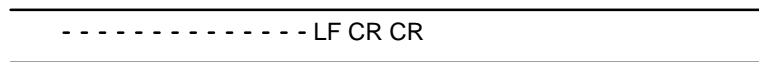
If three-foot feeding is too long, press the **[CAN]** key during feed punching to cancel the subsequent feed punching.

- **TV check**

A space code for TV check is automatically punched.

- **ISO code**

When a program is punched in ISO code, two CR codes are punched after an LF code.



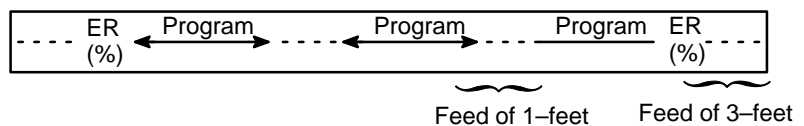
By setting NCR (bit 3 of parameter No. 0100), CRs can be omitted so that each LF appears without a CR.

- **Stopping the punch**

Press the **[RESET]** key to stop punch operation.

- **Punching all programs**

All programs are output to paper tape in the following format.



The sequence of the programs punched is undefined.



8.5 OFFSET DATA INPUT AND OUTPUT

8.5.1 Inputting Offset Data

Offset data is loaded into the memory of the CNC from a floppy or NC tape. The input format is the same as for offset value output. See III- 8.5.2. When an offset value is loaded which has the same offset number as an offset number already registered in the memory, the loaded offset data replaces existing data.

Inputting offset data

Procedure



- 1 Make sure the input device is ready for reading.
For the two-path control, select the tool post for which offset data to be input is used with the tool post selection switch.
- 2 Press the EDIT switch on the machine operator's panel.
- 3 When using a floppy, search for the required file according to the procedure in III-8.2.
- 4 Press function key , then the tool compensation screen appears.
- 5 Press soft keys **[(OPRT)]**.
- 6 Press rightmost soft key  (next menu key).
- 7 Press soft keys **[READ]** and **[EXEC]**.
- 8 The input offset data will be displayed on the screen after completion of input operation.

8.5.2 Outputting Offset Data

All offset data is output in a output format from the memory of the CNC to a floppy or NC tape.

Outputting offset data

Procedure

- 1 Make sure the output device is ready for output.
For the two-path control, select the tool post for which offset data to be input is used with the tool post selection switch.
- 2 Specify the punch code system (ISO or EIA) using a parameter.
- 3 Press the EDIT switch on the machine operator's panel.
- 4 Press function key , then the tool compensation screen appears.
- 5 Press soft key **[(OPRT)]**.
- 6 Press the rightmost soft key  (next-menu key)
- 7 Press soft keys **[PUNCH]** and **[EXEC]**.
Offset data is output in the output format described below.

Explanations

• Output format

Output format is as follows:

Format

- (1) For tool compensation memory A

G10 L11 P_R_;

where P_: Offset No.

R_: Tool compensation amount

- (2) For tool compensation memory B

Setting/changing the geometric compensation amount

G10 L10 P_R_;

Setting/changing the wear compensation amount

G10 L11 P_R_;

- (3) For tool compensation memory C

Setting/changing the geometric compensation amount for H code

G10 L10 P_R_;

Setting/changing the geometric compensation amount for D code

G10 L12 P_R_;

Setting/changing the wear compensation amount for H code

G10 L11 P_R_;

Setting/changing the wear compensation amount for D code

G10 L13 P_R_;

The L1 command may be used instead of L11 for format compatibility of the conventional CNC.

• Output file name

When the floppy disk directory display function is used, the name of the output file is OFFSET.

8.6 INPUTTING AND OUTPUTTING PARAMETERS AND PITCH ERROR COMPENSATION DATA





Parameters and pitch error compensation data are input and output from different screens, respectively. This chapter describes how to enter them.

8.6.1 Inputting Parameters

Parameters are loaded into the memory of the CNC unit from a floppy or NC tape. The input format is the same as the output format. See III-8.6.2. When a parameter is loaded which has the same data number as a parameter already registered in the memory, the loaded parameter replaces the existing parameter.

Inputting parameters

Procedure

- 1 Make sure the input device is ready for reading.
For the two-path control, select the tool post for which parameters to be input are used with the tool post selection switch.
- 2 When using a floppy, search for the required file according to the procedure in III-8.2.
- 3 Press the EMERGENCY STOP button on the machine operator's panel.
- 4 Press function key  .
- 5 Press the soft key **[SETTING]** for chapter selection, then the setting screen appears.
- 6 Enter 1 in response to the prompt for "PARAMETER WRITE (PWE)" in setting data. Alarm P/S100 (indicating that parameters can be written) appears.
- 7 Press soft key  .
- 8 Press chapter selection soft key **[PARAM]**, then the parameter screen appears.
- 9 Press soft key **[(OPRT)]**.
- 10 Press the rightmost soft key  (next-menu key).
- 11 Press soft keys **[READ]** and **[EXEC]**.
Parameters are read into memory. Upon completion of input, the "INPUT" indicator at the lower-right corner of the screen disappears.
- 12 Press function key  .
- 13 Press soft key **[SETTING]** for chapter selection.
- 14 Enter 0 in response to the prompt for "PARAMETER WRITE (PWE)" in setting data.



- 15 Turn the power to the CNC back on.
- 16 Release the EMERGENCY STOP button on the machine operator's panel.

8.6.2 Outputting Parameters

All parameters are output in the defined format from the memory of the CNC to a floppy or NC tape.

Outputting parameters

Procedure

- 1 Make sure the output device is ready for output.
For the two-path control, select the tool post for which parameters to be input are used with the tool post selection switch.
- 2 Specify the punch code system (ISO or EIA) using a parameter.
- 3 Press the EDIT switch on the machine operator's panel.
- 4 Press function key , then the parameter screen appears.
- 5 Press chapter selection soft key **[PARAM]**.
- 6 Press soft key **[(OPRT)]**.
- 7 Press rightmost soft key  (next-menu key).
- 8 Press soft keys **[PUNCH]**.
- 9 To output all parameters, press the **[ALL]** soft key. To output only parameters which are set to other than 0, press the **[NON-0]** soft key.
- 10 Press soft key **[EXEC]**.
All parameters are output in the defined format.

Explanations

- **Output format**

Output format is as follows:

```
N .. P . . . . ;
N .. A1P . A2P .. AnP . . ;
N .. P . . . . ;
```

N . . . : Parameter No.

A . . . : Axis No.(n is the number of control axis)

P . . . : Parameter setting value .

- **Suppressing output of parameters set to 0**

To suppress the output of the following parameters, press the **[PUNCH]** soft key then **[NON-0]** soft key.

	Other than axis type	Axis type
Bit type	Parameter for which all bits are set to 0	Parameter for an axis for which all bits are set to 0.
Value type	Parameter whose value is 0.	Parameter for an axis for which the value is 0.






- **Output file name** When the floppy disk directory display function is used, the name of the output file is PARAMETER.
Once all parameters have been output, the output file is named ALL PARAMETER. Once only parameters which are set to other than 0 have been output, the output file is named NON-0. PARAMETER.

8.6.3 Inputting Pitch error compensation data

Pitch error compensation data are loaded into the memory of the CNC from a floppy or NC tape. The input format is the same as the output format. See **III-8.6.4**. When a pitch error compensation data is loaded which has the corresponding data number as a pitch error compensation data already registered in the memory, the loaded data replaces the existing data.

Pitch error compensation data

Procedure

- 1 Make sure the input device is ready for reading.
For the two-path control, select the tool post for which pitch error compensation data to be input is used with the tool post selection switch.
- 2 When using a floppy, search for the required file according to the procedure in **III-8.2**.
- 3 Press the EMERGENCY STOP button on the machine operator's panel.
- 4 Press function key  .
- 5 Press the soft key **[SETTING]** for chapter selection.
- 6 Enter 1 in response to the prompt for writing parameters (PWE).
Alarm P/S100 (indicating that parameters can be written) appears.
- 7 Press soft key  .
- 8 Press the rightmost soft key  (next-menu key) and press chapter selection soft key **[PITCH]**.
- 9 Press soft key **[(OPRT)]**.
- 10 Press the rightmost soft key  (next-menu key).
- 11 Press soft keys **[READ]** and **[EXEC]**.
Parameters are read into memory. Upon completion of input, the "INPUT" indicator at the lower-right corner of the screen disappears.
- 12 Press function key  .
- 13 Press soft key **[SETTING]** for chapter selection.
- 14 Enter 0 in response to the prompt for "PARAMETER WRITE (PWE)" in setting data.

- 15 Turn the power to the CNC back on.
- 16 Release the EMERGENCY STOP button on the machine operator's panel.

Explanations




- **Pitch error compensation** Parameters 3620 to 3624 and pitch error compensation data must be set correctly to apply pitch error compensation correctly (See III-11.5.2).

8.6.4 Outputting Pitch Error Compensation Data

All pitch error compensation data are output in the defined format from the memory of the CNC to a floppy or NC tape.

Outputting Pitch Error Compensation Data

Procedure

- 1 Make sure the output device is ready for output.
For the two-path control, select the tool post for which pitch error compensation data to be input is used with the tool post selection switch.
- 2 Specify the punch code system (ISO or EIA) using a parameter.
- 3 Press the EDIT switch on the machine operator's panel.
- 4 Press function key  .
- 5 Press the rightmost soft key  (next-menu key) and press chapter selection soft key **[PITCH]**.
- 6 Press soft key **[(OPRT)]**.
- 7 Press rightmost soft key  (next-menu key).
- 8 Press soft keys **[PUNCH]** and **[EXEC]**.
All parameters are output in the defined format.

Explanations

- **Output format** Output format is as follows:
N 10000 P ;
N 11023 P ;
N . . : Pitch error compensation point No. +10000
P . . . : Pitch error compensation data
- **Output file name** When the floppy disk directory display function is used, the name of the output file is **"PITCH ERROR"**.

8.7 INPUTTING/OUTPUTTING CUSTOM MACRO COMMON VARIABLES

8.7.1 Inputting Custom Macro Common Variables


The value of a custom macro common variable (#500 to #999) is loaded into the memory of the CNC from a floppy or NC tape. The same format used to output custom macro common variables is used for input. See III-8.7.2. For a custom macro common variable to be valid, the input data must be executed by pressing the cycle start button after data is input. When the value of a common variable is loaded into memory, this value replaces the value of the same common variable already existing (if any) in memory.

Inputting custom macro common variables

Procedure

- 1 Register the program which has been output, as described in Section III-8.7.2, in memory according to the program input procedure described in Section III-8.4.1.
- 2 Press the MEMORY switch on the machine operator's panel upon completing input.
- 3 Press the cycle start button to execute the loaded program.
- 4 Display the macro variable screen to check whether the values of the common variables have been set correctly.

Display of the macro variable screen

- Press function key  .
- Press the rightmost soft key (next-menu key).
- Press soft key **[MACRO]**.
- Select a variable with the page keys or numeric keys and soft key **[NO.SRH]**.

Explanations

- **Common variables**




The common variables (#500 to #531) can be input and output. When the option for adding a common variable is specified, values from #500 to #999 can be input and output. #100 to #199 can be input and output when bit 3 (PU5) of parameter No. 6001 is set to 1.

8.7.2 Outputting Custom Macro Common Variable

Custom macro common variables (#500 to #999) stored in the memory of the CNC can be output in the defined format to a floppy or NC tape.

Outputting custom macro common variable

Procedure

- 1 Make sure the output device is ready for output.
- 2 Specify the punch code system (ISO or EIA) using a parameter.
- 3 Press the EDIT switch on the machine operator's panel.
- 4 Press function key  .
- 5 Press the rightmost soft key  (next-menu key), then press soft key **[MACRO]**.
- 6 Press soft key **[(OPRT)]**.
- 7 Press the rightmost soft key  (next-menu key).
- 8 Press soft keys **[PUNCH]** and **[EXEC]**.
Common variables are output in the defined format.

Explanations

- **Output format**

The output format is as follows:

```

%
;
#500=[25283*65536+65536]/134217728 ..... (1)
#501=#0; ..... (2)
#502=0; ..... (3)
#503= ..... ;
..... ;
..... ;
#531= ..... ;
M02;
%
```

- (1) The precision of a variable is maintained by outputting the value of the variable as <expression>.
- (2) Undefined variable
- (3) When the value of a variable is 0

- **Output file name**

When the floppy disk directory display function is used, the name of the output file is “**MACRO VAR**”.

- **Common variable**

The common variables (#500 to #531) can be input and output. When the option for adding a common variable is specified, values from #500 to #999 can be input and output. #100 to #199 can be input and output when bit 3 (PU5) of parameter No. 6001 is set to 1.

8.8 DISPLAYING DIRECTORY OF FLOPPY CASSETTE

On the floppy directory display screen, a directory of the FANUC Handy File, FANUC Floppy Cassette, or FANUC FA Card files can be displayed. In addition, those files can be loaded, output, and deleted.

DIRECTORY (FLOPPY)		O0001 N0000
NO.	FILE NAME	(METER) VOL
0001	PARAMETER	58.5
0002	O0001	1.9
0003	O0002	1.9
0004	O0010	1.3
0005	O0040	1.3
0006	O0050	1.9
0007	O0100	1.9
0008	O1000	1.9
0009	O9500	1.6

EDIT **** * * * * 11 : 51 : 12





{ PRGRM } { } { DIR } { } { OPRT }

8.8.1 Displaying the Directory

Displaying the directory of floppy cassette files

Procedure 1

Use the following procedure to display a directory of all the files stored in a floppy:

- 1 Press the EDIT switch on the machine operator's panel.
- 2 Press function key  .
- 3 Press the rightmost soft key  (next-menu key).
- 4 Press soft key [FLOPPY].
- 5 Press page key  or  .
- 6 The screen below appears.

DIRECTORY (FLOPPY)		O0001 N00000
NO.	FILE NAME	(METER) VOL
0001	PARAMETER	58.5
0002	O0001	1.9
0003	O0002	1.9
0004	O0010	1.3
0005	O0040	1.3
0006	O0050	1.9
0007	O0100	1.9
0008	O1000	1.9
0009	O9500	1.6

EDIT ***** 11 : 53 : 04



{ F SRH } { READ } { PUNCH } { DELETE } { }

Fig.8.8.1 (a)

- 7 Press a page key again to display another page of the directory.

Procedure 2

Use the following procedure to display a directory of files starting with a specified file number :

- 1 Press the EDIT switch on the machine operator's panel.
- 2 Press function key  .
- 3 Press the rightmost soft key  (next-menu key).
- 4 Press soft key **[FLOPPY]**.
- 5 Press soft key **[(OPRT)]**.
- 6 Press soft key **[F SRH]**.
- 7 Enter a file number.
- 8 Press soft keys **[F SET]** and **[EXEC]**.
- 9 Press a page key to display another page of the directory.
- 10 Press soft key **[CAN]** to return to the soft key display shown in the screen of **Fig 8.8.1 (a)**.

DIRECTORY (FLOPPY)		O0001 N0000
NO.	FILE NAME	(METER) VOL
0005	O0040	1.3
0006	O0050	1.9
0007	O0100	1.9
0008	O1000	1.9
0009	O9500	1.6

SEARCH					
FILE NO. =					
>					
EDIT	****	***	***		11 : 54 : 19
(F SET)	()	()	()	(CAN)	(EXEC)

Fig.8.8.1 (b)

Explanations

- **Screen fields and their meanings**

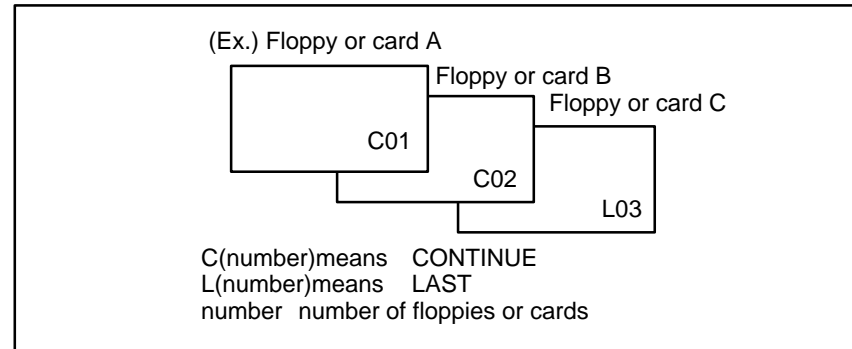
NO:Displays the file number

FILE NAME: Displays the file name.

(METER) : Converts and prints out the file capacity to paper tape length. You can also produce H

(FEET) I by setting the INPUT UNIT to INCH of the setting data.

VOL. : When the file is multi-volume, that state is displayed.





8.8.2 Reading Files

The contents of the specified file number are read to the memory of NC.

Reading files

Procedure

- 1 Press the EDIT switch on the machine operator's panel.
For the two-path control, select the tool post for which a file is to be input in memory with the tool post selection switch.
- 2 Press function key  .
- 3 Press the rightmost soft key  (next-menu key).
- 4 Press soft key **[FLOPPY]**.
- 5 Press soft key **[(OPRT)]**.
- 6 Press soft key **[READ]**.

```

DIRECTOR (FLOPPY)                O0001 N00000
NO. FILE NAME                    (METER) VOL
0001 PARAMETER                   58.5
0002 O0001                       1.9
0003 O0002                       1.9
0004 O0010                       1.3
0005 O0040                       1.3
0006 O0050                       1.9
0007 O0100                       1.9
0008 O1000                       1.9
0009 O9500                       1.6
READ
FILE NO. =                      PROGRAM NO. =
>_
EDIT ***** 11 : 55 : 04
( F SET ) ( O SET ) ( STOP ) ( CAN ) ( EXEC )

```



- 7 Enter a file number.
- 8 Press soft key **[F SET]**.
- 9 To modify the program number, enter the program number, then press soft key **[O SET]**.
- 10 Press soft key **[EXEC]**. The file number indicated in the lower-left corner of the screen is automatically incremented by one.
- 11 Press soft key **[CAN]** to return to the soft key display shown in the screen of **Fig. 8.8.1(a)**.

8.8.3 Outputting Programs

Any program in the memory of the CNC unit can be output to a floppy as a file.

Outputting programs

Procedure

- 1 Press the EDIT switch on the machine operator's panel.
For the two-path control, select the tool post for which a file is to be input in memory with the tool post selection switch.
- 2 Press function key  .
- 3 Press the rightmost soft key  (next-menu key).
- 4 Press soft key **[FLOPPY]**.
- 5 Press soft key **[(OPRT)]**.
- 6 Press soft key **[PUNCH]**.

```

DIRECTOR (FLOPPY)          O0002 N01000
NO. FILE NAME              (METER) VOL
0001 PARAMETER             58.5
0002 O0001                  1.9
0003 O0002                  1.9
0004 O0010                  1.3
0005 O0040                  1.3
0006 O0050                  1.9
0007 O0100                  1.9
0008 O1000                  1.9
0009 O9500                  1.6
PUNCH
FILE NO. =                  PROGRAM NO. =
>_
EDIT ***** 11 : 55 : 26
( F SET ) ( O SET ) ( STOP ) ( CAN ) ( EXEC )

```



- 7 Enter a program number. To write all programs into a single file, enter -9999 in the program number field. In this case, the file name "ALL.PROGRAM" is registered.
- 8 Press soft key **[O SET]**.
- 9 Press soft key **[EXEC]**. The program or programs specified in step 7 are written after the last file on the floppy. To output the program after deleting files starting with an existing file number, key in the file number, then press soft key **[F SET]** followed by soft key **[EXEC]**.
- 10 Press soft key **[CAN]** to return to the soft key display shown in the screen of **Fig.8.8.1(a)**.

8.8.4 Deleting Files

The file with the specified file number is deleted.

Deleting files

Procedure

- 1 Press the EDIT switch on the machine operator's panel.
- 2 Press function key  .
- 3 Press the rightmost soft key  (next-menu key).
- 4 Press soft key **[FLOPPY]**.
- 5 Press soft key **[(OPRT)]**.
- 6 Press soft key **[DELETE]**.

```

DIRECTOR (FLOPPY)                O0001 N00000
NO. FILE NAME                    (METER) VOL
0001 PARAMETER                   58.5
0002 O0001                       1.9
0003 O0002                       1.9
0004 O0010                       1.3
0005 O0040                       1.3
0006 O0050                       1.9
0007 O0100                       1.9
0008 O1000                       1.9
0009 O9500                       1.6
DELETE
FILE NO. =      NAME=
>_
EDIT  ****  ***  ***                11 : 55 : 51
( F SET ) ( F NAME ) (           ) ( CAN ) ( EXEC )

```

- 7 Specify the file to be deleted.
When specifying the file with a file number, type the number and press soft key **[F SET]**. When specifying the file with a file name, type the name and press soft key **[F NAME]**.
- 8 Press soft key **[EXEC]**.
The file specified in the file number field is deleted. When a file is deleted, the file numbers after the deleted file are each decremented by one.
- 9 Press soft key **[CAN]** to return to the soft key display shown in the screen of **Fig. 8.8.1(a)**.

Restrictions

- **Inputting file numbers and program numbers with keys**
If **[F SET]** or **[O SET]** is pressed without key inputting file number and program number, file number or program number shows blank. When 0 is entered for file numbers or program numbers, 1 is displayed.
- **I/O devices**
To use channel 0 ,set a device number in parameter (No. 102).
Set the I/O device number to parameter (No. 112) when channel 1 is used.
Set it to (No. 0122) when channel 2 is used.
- **Significant digits**
For the numeral input in the data input area with FILE No. and PROGRAM No., only lower 4 digits become valid.
- **Collation**
When the data protection key on the machine operator's panel is ON, no programs are read from the floppy. They are verified against the contents of the memory of the CNC instead.

ALARM

Alarm No.	Contents
71	An invalid file number or program number was entered. (Specified program number is not found.)
79	Verification operation found a mismatch between a program loaded into memory and the contents of the floppy
86	The dataset-ready signal (DR) for the input/output device is turned off. (The no file error or duplicate file error occurred on the input/output device because an invalid file number, program number, or file name was entered.)

8.9 OUTPUTTING A PROGRAM LIST FOR A SPECIFIED GROUP

CNC programs stored in memory can be grouped according to their names, thus enabling the output of CNC programs in group units. Section III-11.3.3 explains the display of a program listing for a specified group.

Procedure for Outputting a Program List for a Specified Group

Procedure

- 1 Display the program list screen for a group of programs, as described in Section III-11.3.2.

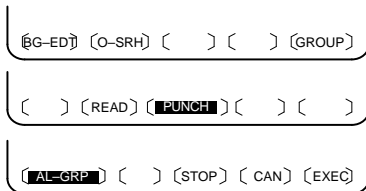
```


PROGRAM DIRECTORY (GROUP)          O0001 N00010

      PROGRAM (NUM.)      MEMORY (CHAR.)
USED:          60          3321
FREE:          2          429
O0020 (GEAR-1000 MAIN   )
O0040 (GEAR-1000 SUB-1  )
O0200 (GEAR-1000 SUB-2  )
O2000 (GEAR-1000 SUB-3  )

>_
EDIT  ****  ***  ***  ***  16:52:13
〔PRGRM〕〔 DIR 〕〔   〕〔   〕〔 (OPRT) 〕

```



- 2 Press the **〔OPRT〕** operation soft key.
- 3 Press the right-most soft key  (continuous menu key).
- 4 Press the **〔PUNCH〕** operation soft key.
- 5 Press the **〔AL-GRP〕** operation soft key.

The CNC programs in the group for which a search is made are output. When these programs are output to a floppy disk, they are output to a file named GROUP.PROGRAM.

8.10 DATA INPUT/OUTPUT ON THE ALL IO SCREEN

To input/output a particular type of data, the corresponding screen is usually selected. For example, the parameter screen is used for parameter input from or output to an external input/output unit, while the program screen is used for program input or output. However, programs, parameters, offset data, and macro variables can all be input and output using a single common screen, that is, the ALL IO screen.

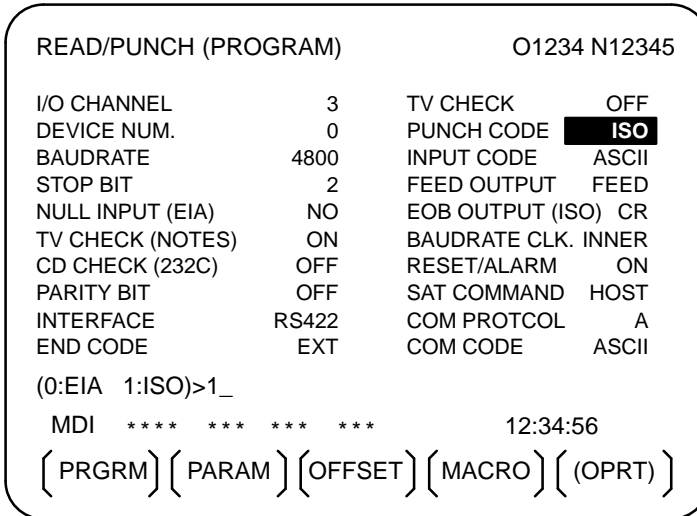




Fig. 8.10 ALL IO screen (when channel 3 is being used for input/output)

8.10.1 Setting Input/Output-Related Parameters

Input/output-related parameters can be set on the ALL IO screen. Parameters can be set, regardless of the mode.

Setting input/output-related parameters

Procedure

- 1 Press function key  .
- 2 Press the rightmost soft key  (next-menu key) several times.
- 3 Press soft key **[ALL IO]** to display the ALL IO screen.

NOTE

- 1 If program or floppy is selected in EDIT mode, the program directory or floppy screen is displayed.
- 2 When the power is first turned on, program is selected by default.

```

READ/PUNCH (PROGRAM)                O1234 N12345

I/O CHANNEL          3      TV CHECK      OFF
DEVICE NUM.          0      PUNCH CODE    ISO
BAUDRATE             4800    INPUT CODE   ASCII
STOP BIT             2      FEED OUTPUT  FEED
NULL INPUT (EIA)     NO     EOB OUTPUT (ISO) CR
TV CHECK (NOTES)     ON     BAUDRATE CLK. INNER
CD CHECK (232C)      OFF    RESET/ALARM   ON
PARITY BIT           OFF    SAT COMMAND   HOST
INTERFACE            RS422   COM PROTOCOL  A
END CODE             EXT    COM CODE      ASCII

(0:EIA 1:ISO)>1_
MDI  ****  ***  ***  ***  12:34:56
{ PRGRM } { PARAM } { OFFSET } { MACRO } { (OPRT) }

```

NOTE

Baud rate clock, CD check (232C), reset/alarm report, and the parity bit for parameter No. 134, as well as the communication code, end code, communication protocol, interface, and SAT command for parameter No. 135 are displayed only when channel 3 is being used for input/output.

- 4 Select the soft key corresponding to the desired type of data (program, parameter, and so forth).
- 5 Set the parameters corresponding to the type of input/output unit to be used. (Parameter setting is possible regardless of the mode.)

8.10.2 Inputting and Outputting Programs

A program can be input and output using the ALL IO screen.
When entering a program using a cassette or card, the user must specify the input file containing the program (file search).

File search

Procedure

- 1 Press soft key **[PRGRM]** on the ALL IO screen, described in Section 8.10.1.
- 2 Select **EDIT** mode. A program directory is displayed.
- 3 Press soft key **[(OPRT)]**. The screen and soft keys change as shown below.
 - A program directory is displayed only in EDIT mode. In all other modes, the ALL IO screen is displayed.

```

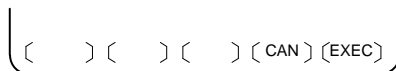
                                O0001 N00010
                                PROGRAM (NUM.)    MEMORY (CHAR.)
                                USED  :    60      3321
                                FREE  :     2      429

                                O0010 O0001 O0003 O0002 O0555 O0999
                                O0062 O0004 O0005 O1111 O0969 O6666
                                O0021 O1234 O0588 O0020 O0040

                                >_
                                EDIT  ****  ***  ***  ***          14:46:09
                                { F SRH } { READ } { PUNCH } { DELETE } { (OPRT) }

```

- 4 Enter address N.
- 5 Enter the number of the file to be found.
 - N0
The first floppy file is found.
 - One of N1 to N9999
Among the files numbered from 1 to 9999, a specified file is found.
 - N-9999
The file immediately after that used most recently is found.
 - N-9998
When -9998 is specified, the next file is found. Then, each time a file input/output operation is performed, N-9999 is automatically inserted. This means that subsequent files can be sequentially found automatically.
This state is canceled by specifying N0, N1 to N9999, or N-9999, or upon a reset.



- 6 Press soft keys **[F SRH]** and **[EXEC]**.
The specified file is found.

Explanations

- **Difference between N0 and N1**

When a file already exists in a cassette or card, specifying N0 or N1 has the same effect. If N1 is specified when there is no file on the cassette or card, an alarm is issued because the first file cannot be found. Specifying N0 places the head at the start of the cassette or card, regardless of whether the cassette/card already contains files. So, no alarm is issued in this case. N0 can be used, for example, when a program is written into a new cassette or card, or when a previously used cassette or card is used once all the files it contains have been erased.

- **Alarm issue during file search**

If an alarm (file search failure, for example) is generated during file search, the CNC does not issue an alarm immediately. However, a P/S alarm (No. 086) is issued if input/output is subsequently performed on that file.

- **File search using N-9999**

Instead of sequentially searching for files by specifying actual file numbers every time, the user can specify the first file number, then find the subsequent files by specifying N-9999. When N-9999 is specified, the time required for file search can be reduced.

Inputting a program

Procedure

- 1 Press soft key **[PRGRM]** on the ALL IO screen, described in Section 8.10.1.
- 2 Select EDIT mode. A program directory is displayed.
- 3 Press soft key **[(OPRT)]**. The screen and soft keys change as shown below.
 - A program directory is displayed only in EDIT mode. In all other modes, the ALL IO screen is displayed.

```

                                O0001 N00010
                                PROGRAM (NUM.)   MEMORY (CHAR.)
                                USED   :    60      3321
                                FREE   :    2       429

                                O0010 O0001 O0003 O0002 O0555 O0999
                                O0062 O0004 O0005 O1111 O0969 O6666
                                O0021 O1234 O0588 O0020 O0040

                                >_
                                EDIT ****  ***  ***  ***          14:46:09
                                ( F SRH ) ( READ ) ( PUNCH ) ( DELETE ) ( (OPRT) )

```

- 4 To specify a program number to be assigned to an input program, enter address O, followed by the desired program number. If no program number is specified, the program number in the file or on the NC tape is assigned as is.
- 5 Press soft key **[READ]**, then **[EXEC]**. The program is input with the program number specified in step 4 assigned. To cancel input, press soft key **[CAN]**. To stop input prior to its completion, press soft key **[STOP]**.

() () (STOP) (CAN) (EXEC)

Outputting programs

Procedure

- 1 Press soft key **[PRGRM]** on the ALL IO screen, described in Section 8.10.1.
- 2 Select EDIT mode. A program directory is displayed.
- 3 Press soft key **[(OPRT)]**. The screen and soft keys change as shown below.
 - A program directory is displayed only in EDIT mode. In all other modes, the ALL IO screen is displayed.

```

                                O0001 N00010
                                PROGRAM (NUM.)   MEMORY (CHAR.)
                                USED   :    60      3321
                                FREE   :    2       429

                                O0010 O0001 O0003 O0002 O0555 O0999
                                O0062 O0004 O0005 O1111 O0969 O6666
                                O0021 O1234 O0588 O0020 O0040

                                >_
                                EDIT ****  ***  ***  ***  14:46:09
                                ( F SRH ) ( READ ) ( PUNCH ) ( DELETE ) ( OPRT )

```

- 4 Enter address O.
- 5 Enter a desired program number.
If -9999 is entered, all programs in memory are output.
To output a range of programs, enter OΔΔΔΔ, O□□□□. The programs numbered from ΔΔΔΔ to □□□□ are output.
When bit 4 (SOR) of parameter No. 3107 for sorted display is set to 1 on the program library screen, programs are output in order, starting from those having the smallest program numbers.
- 6 Press soft key **[PUNCH]**, then **[EXEC]**.
The specified program or programs are output. If steps 4 and 5 are omitted, the currently selected program is output.
To cancel output, press soft key **[CAN]**.
To stop output prior to its completion, press soft key **[STOP]**.

{ () () (STOP) (CAN) (EXEC) }

Deleting files

Procedure

- 1 Press soft key **[PRGRM]** on the ALL IO screen, described in Section 8.10.1.
- 2 Select EDIT mode. A program directory is displayed.
- 3 Press soft key **[(OPRT)]**. The screen and soft keys change as shown below.
 - A program directory is displayed only in EDIT mode. In all other modes, the ALL IO screen is displayed.

```

                                O0001 N00010
                                PROGRAM (NUM.)   MEMORY (CHAR.)
                                USED   :    60      3321
                                FREE   :    2       429

                                O0010 O0001 O0003 O0002 O0555 O0999
                                O0062 O0004 O0005 O1111 O0969 O6666
                                O0021 O1234 O0588 O0020 O0040

                                >_
                                EDIT  ****  ***  ***  ***          14:46:09
                                ( F SRH ) ( READ ) ( PUNCH ) ( DELETE ) ( (OPRT) )

```

- 4 Press soft key **[DELETE]**.
- 5 Enter a file number, from 1 to 9999, to indicate the file to be deleted.
- 6 Press soft key **[EXEC]**.
The k-th file, specified in step 5, is deleted.

```

( ) ( ) ( ) ( ) ( CAN ) ( EXEC )

```

Explanations

- **File numbers after deletion**

After deletion of the k-th file, the previous file numbers (k+1) to n are decremented by 1 to k to (n-1).

Before deletion	After deletion
1 to (k-1)	1 to (k-1)
K	Delete
(k+1) to n	k to (n-1)

- **Write protect**

Before a file can be deleted, the write protect switch of the cassette must be set to make the cassette writable.

8.10.3 Inputting and Outputting Parameters

Parameters can be input and output using the ALL IO screen.

Inputting parameters

Procedure

- 1 Press soft key **[PARAM]** on the ALL IO screen, described in Section 8.10.1.
- 2 Select EDIT mode.
- 3 Press soft key **[(OPRT)]**. The screen and soft keys change as shown below.

```

READ/PUNCH (PARAMETER)                O1234 N12345

I/O CHANNEL          3      TV CHECK      OFF
DEVICE NUM.          0      PUNCH CODE    ISO
BAUDRATE             4800    INPUT CODE   ASCII
STOP BIT             2      FEED OUTPUT  FEED
NULL INPUT (EIA)     NO     EOB OUTPUT (ISO) CR
TV CHECK (NOTES)     ON     BAUDRATE CLK. INNER
CD CHECK (232C)      OFF    RESET/ALARM     ON
PARITY BIT           OFF    COM CODE        ASCII
END CODE             EXT    COM PROTOCOL    A
INTERFACE            RS422   SAT COMMAND     HOST

(0:EIA 1:ISO)>1_
MDI  ****  ***  ***  ***
      {      } { READ } { PUNCH } {      } {      }

```

```

{      } {      } {      } { CAN } { EXEC }

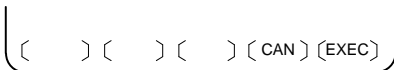
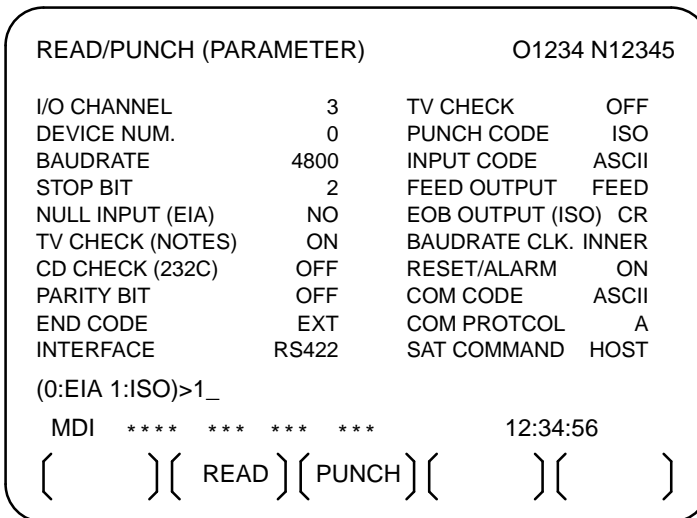
```

- 4 Press soft key **[READ]**, then **[EXEC]**.
The parameters are read, and the "INPUT" indicator blinks at the lower-right corner of the screen. Upon the completion of input, the "INPUT" indicator is cleared from the screen.
To cancel input, press soft key **[CAN]**.

Outputting parameters

Procedure

- 1 Press soft key **[PARAM]** on the ALL IO screen, described in Section 8.10.1.
- 2 Select EDIT mode.
- 3 Press soft key **[(OPRT)]**. The screen and soft keys change as shown below.



- 4 Press soft key **[PUNCH]**, then **[EXEC]**.
 The parameters are output, and the "OUTPUT" indicator blinks at the lower-right corner of the screen. Upon the completion of output, the "OUTPUT" indicator is cleared from the screen.
 To cancel output, press soft key **[CAN]**.

8.10.4 Inputting and Outputting Offset Data

Offset data can be input and output using the ALL IO screen.

Inputting offset data

Procedure

- 1 Press soft key **[OFFSET]** on the ALL IO screen, described in Section 8.10.1.
- 2 Select EDIT mode.
- 3 Press soft key **[(OPRT)]**. The screen and soft keys change as shown below.

```

READ/PUNCH (OFFSET)                                O1234 N12345

I/O CHANNEL          3      TV CHECK          OFF
DEVICE NUM.          0      PUNCH CODE        ISO
BAUDRATE             4800    INPUT CODE       ASCII
STOP BIT             2      FEED OUTPUT    FEED
NULL INPUT (EIA)     NO     EOB OUTPUT (ISO) CR
TV CHECK (NOTES)     ON     BAUDRATE CLK. INNER
CD CHECK (232C)      OFF    RESET/ALARM     ON
PARITY BIT           OFF    COM CODE        ASCII
END CODE             EXT    COM PROTOCOL    A
INTERFACE            RS422   SAT COMMAND     HOST

(0:EIA 1:ISO)>1_
  MDI  ****  ***  ***  ***  12:34:56
  (    ) ( READ ) ( PUNCH ) (    ) (    )

```

```

(    ) (    ) (    ) ( CAN ) ( EXEC )

```

- 4 Press soft key **[READ]**, then **[EXEC]**.
The offset data is read, and the "INPUT" indicator blinks at the lower-right corner of the screen.
Upon the completion of input, the "INPUT" indicator is cleared from the screen.
To cancel input, press soft key **[CAN]**.

Outputting offset data

Procedure

- 1 Press soft key **[OFFSET]** on the ALL IO screen, described in Section 8.10.1.
- 2 Select EDIT mode.
- 3 Press soft key **[(OPRT)]**. The screen and soft keys change as shown below.

```

READ/PUNCH (OFFSET)                                O1234 N12345

I/O CHANNEL          3      TV CHECK          OFF
DEVICE NUM.          0      PUNCH CODE        ISO
BAUDRATE             4800    INPUT CODE      ASCII
STOP BIT             2      FEED OUTPUT     FEED
NULL INPUT (EIA)     NO     EOB OUTPUT (ISO) CR
TV CHECK (NOTES)     ON     BAUDRATE CLK. INNER
CD CHECK (232C)      OFF    RESET/ALARM      ON
PARITY BIT           OFF    COM CODE         ASCII
END CODE             EXT    COM PROTOCOL     A
INTERFACE            RS422   SAT COMMAND      HOST

(0:EIA 1:ISO)>1_
MDI  ****  ***  ***  ***
      {      } { READ } { PUNCH } {      } {      }

```

```

{      } {      } {      } { CAN } { EXEC }

```

- 4 Press soft key **[PUNCH]**, then **[EXEC]**.
The offset data is output, and the "OUTPUT" indicator blinks at the lower-right corner of the screen. Upon the completion of output, the "OUTPUT" indicator is cleared from the screen.
To cancel output, press soft key **[CAN]**.

8.10.5 Outputting Custom Macro Common Variables

Custom macro common variables can be output using the ALL IO screen.

Outputting custom macro common variables

Procedure

- 1 Press soft key **[MACRO]** on the ALL IO screen, described in Section 8.10.1.
- 2 Select EDIT mode.
- 3 Press soft key **[(OPRT)]**. The screen and soft keys change as shown below.

```

READ/PUNCH (MACRO)                                O1234 N12345

I/O CHANNEL          3      TV CHECK          OFF
DEVICE NUM.          0      PUNCH CODE        ISO
BAUDRATE             4800    INPUT CODE      ASCII
STOP BIT             2      FEED OUTPUT    FEED
NULL INPUT (EIA)     NO     EOB OUTPUT (ISO) CR
TV CHECK (NOTES)     ON     BAUDRATE CLK. INNER
CD CHECK (232C)      OFF    RESET/ALARM    ON
PARITY BIT           OFF    COM CODE       ASCII
END CODE             EXT    COM PROTOCOL   A
INTERFACE            RS422   SAT COMMAND    HOST

(0:EIA 1:ISO)>1_
MDI  ****  ***  ***  ***  12:34:56
(      )( READ )( PUNCH )(      )(      )

```

```

(      )(      )(      )( CAN )( EXEC )

```

- 4 Press soft key **[PUNCH]**, then **[EXEC]**.
The custom macro common variables are output, and the "OUTPUT" indicator blinks at the lower-right corner of the screen. Upon the completion of output, the "OUTPUT" indicator is cleared from the screen.
To cancel output, press soft key **[CAN]**.

NOTE


To input a macro variable, read the desired custom macro statement as a program, then execute the program.

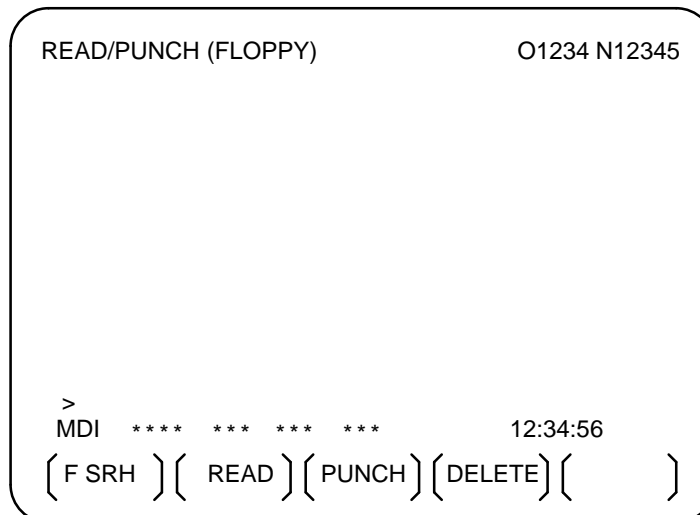
8.10.6 Inputting and Outputting Floppy Files

The ALL IO screen supports the display of a directory of floppy files, as well as the input and output of floppy files.

Displaying a file directory

Procedure

- 1 Press the rightmost soft key  (next–menu key) on the ALL IO screen, described in Section 8.10.1.
- 2 Press soft key **[FLOPPY]**.
- 3 Select EDIT mode. The floppy screen is displayed.
- 4 Press soft key **[(OPRT)]**. The screen and soft keys change as shown below.
 - The floppy screen is displayed only in EDIT mode. In all other modes, the ALL IO screen is displayed.



- 5 Press soft key **[F SRH]**.
- 6 Enter the number of the desired file, then press soft key **[F SET]**.
- 7 Press soft key **[EXEC]**. A directory is displayed, with the specified file uppermost. Subsequent files in the directory can be displayed by pressing the page key.


[F SET] [] [] [CAN] [EXEC]

READ/PUNCH (FLOPPY)		O1234 N12345
No.	FILE NAME	(Meter) VOL
0001	PARAMETER	46.1
0002	ALL.PROGRAM	12.3
0003	O0001	1.9
0004	O0002	1.9
0005	O0003	1.9
0006	O0004	1.9
0007	O0005	1.9
0008	O0010	1.9
0009	O0020	1.9
F SRH		
File No.=2		
>2_		
EDIT	**** * * * * *	12:34:56
{ F SRH }	{ }	{ CAN }
{ }	{ }	{ EXEC }

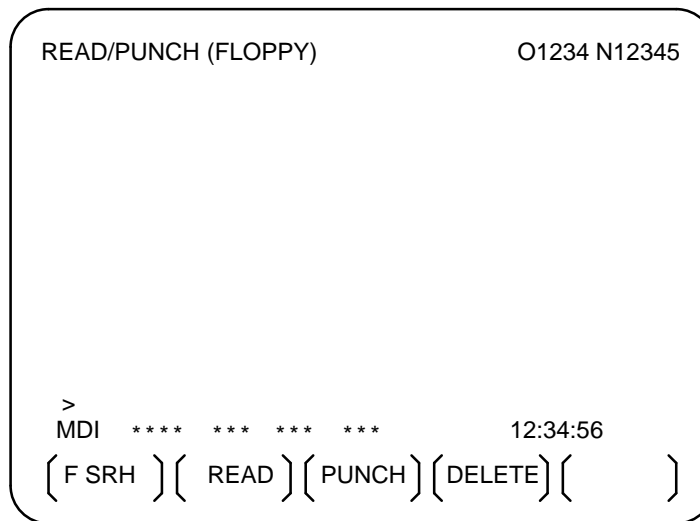
A directory in which the first file is uppermost can be displayed simply by pressing the page key. (Soft key **[F SRH]** need not be pressed.)

Inputting a file

Procedure

- 1 Press the rightmost soft key  (next-menu key) on the ALL IO screen, described in Section 8.10.1.
- 2 Press soft key **[FLOPPY]**.
- 3 Select EDIT mode. The floppy screen is displayed.
- 4 Press soft key **[(OPRT)]**. The screen and soft keys change as shown below.

The floppy screen is displayed only in EDIT mode. In all other modes, the ALL IO screen is displayed.




- 5 Press soft key **[READ]**.
- 6 Enter the number of a file or program to be input.
 - Setting a file number: Enter the number of the desired file, then press soft key **[F SET]**.
 - Setting a program number: Enter the number of the desired program, then press soft key **[O SET]**.
- 7 Press soft key **[EXEC]**.
The specified file or program is read, and the "INPUT" indicator blinks at the lower-right corner of the screen. Upon the completion of input, the "INPUT" indicator is cleared from the screen.

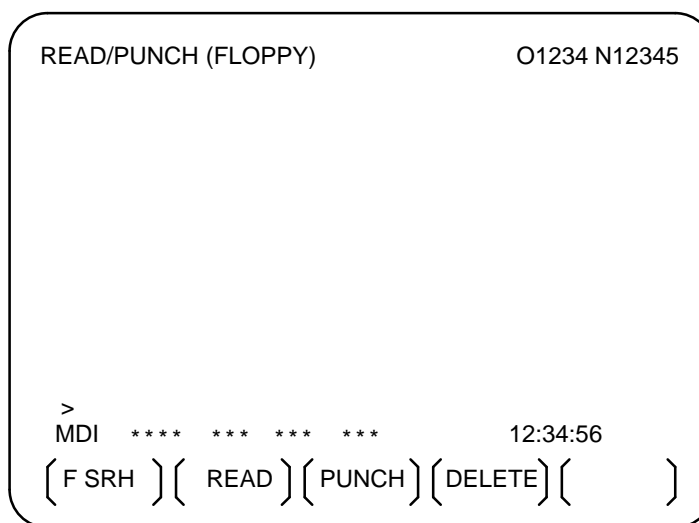
[F SET] [O SET] [STOP] [CAN] [EXEC]

Outputting a file

Procedure

- 1 Press the rightmost soft key  (next-menu key) on the ALL IO screen, described in Section 8.10.1.
- 2 Press soft key **[FLOPPY]**.
- 3 Select EDIT mode. The floppy screen is displayed.
- 4 Press soft key **[(OPRT)]**. The screen and soft keys change as shown below.

The floppy screen is displayed only in EDIT mode. In all other modes, the ALL IO screen is displayed.




- 5 Press soft key **[PUNCH]**.
- 6 Enter the number of the program to be output, together with a desired output file number.
 - Setting a file number: Enter the number of the desired file, then press soft key **[F SET]**.
 - Setting a program number: Enter the number of the desired program, then press soft key **[O SET]**.
- 7 Press soft key **[EXEC]**.
The specified program is output, and the "OUTPUT" indicator blinks at the lower-right corner of the screen. Upon the completion of output, the "OUTPUT" indicator is cleared from the screen.
If no file number is specified, the program is written at the end of the currently registered files.

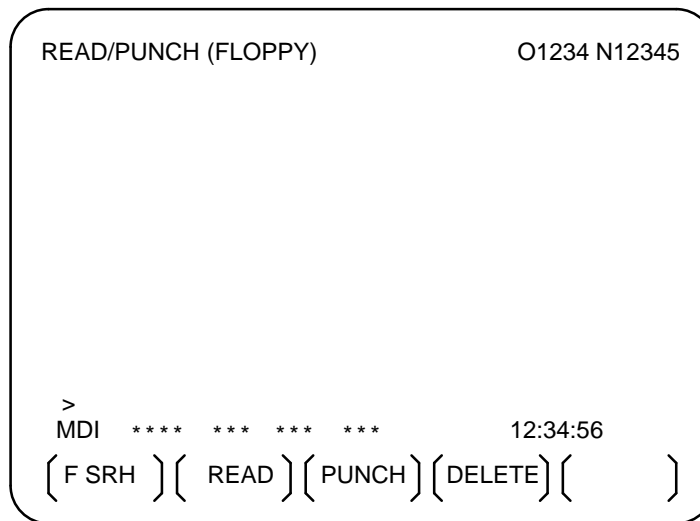
[F SET] [O SET] [STOP] [CAN] [EXEC]

Deleting a file

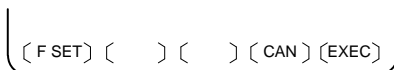
Procedure

- 1 Press the rightmost soft key  (next-menu key) on the ALL IO screen, described in Section 8.10.1.
- 2 Press soft key **[FLOPPY]**.
- 3 Select EDIT mode. The floppy screen is displayed.
- 4 Press soft key **[(OPRT)]**. The screen and soft keys change as shown below.

The floppy screen is displayed only in EDIT mode. In all other modes, the ALL IO screen is displayed.



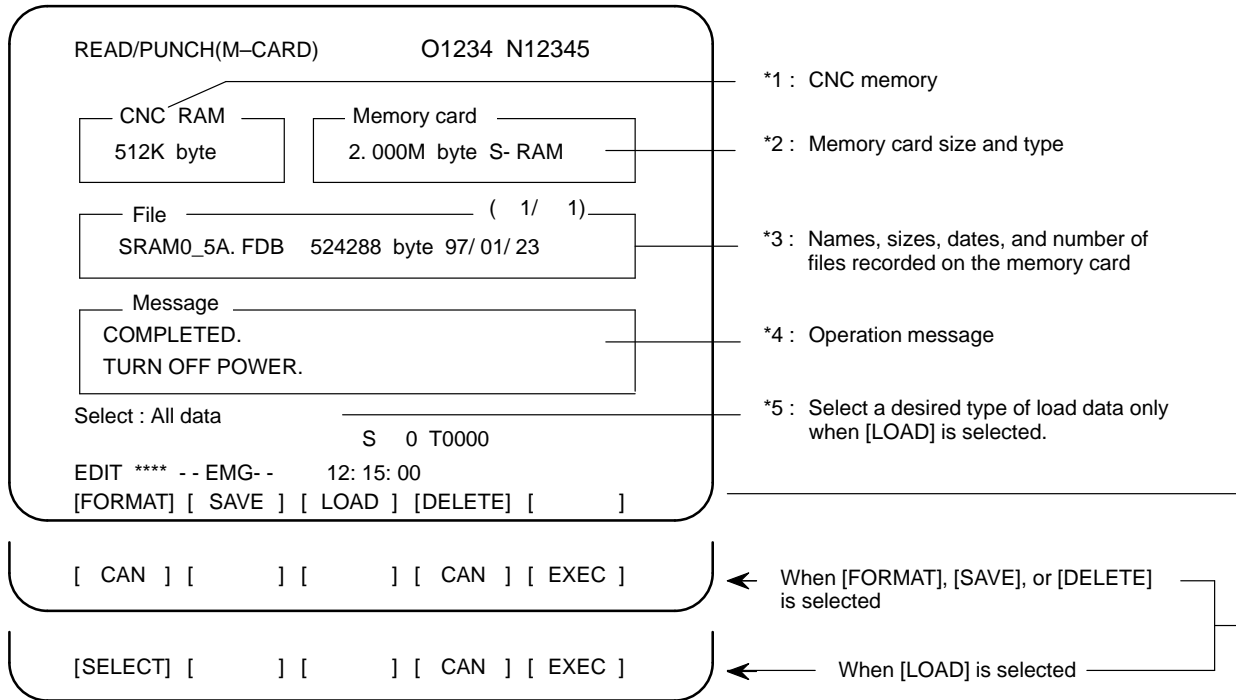
- 5 Press soft key **[DELETE]**.
- 6 Enter the number of the desired file, then press soft key **[F SET]**.
- 7 Press soft key **[EXEC]**. The specified file is deleted. After the file has been deleted, the subsequent files are shifted up.



8.10.7 Memory Card Input/Output

Data held in CNC memory can be saved to a memory card in MS-DOS format. Data held on a memory card can be loaded into CNC memory. A save or load operation can be performed using soft keys while the CNC is operating.

Loading can be performed in either of two ways. In the first method, all saved memory data is loaded. In the second method, only selected data is loaded.




- The CNC memory size (*1) is displayed at all times.
- When no memory card is inserted, the message field (*4) displays a message prompting the user to insert a memory card, but does not display the memory card states (*2 and *3).
- If an inserted memory card is invalid (if there is no attribute memory, or if the attribute memory does not contain any device information), the message field (*4) displays an error message, but does not display the memory card states (*2 and *3).

Saving memory data

Data held in CNC memory can be saved to a memory card in MS-DOS format.

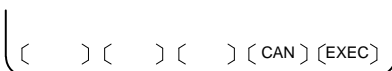
Saving memory data

Procedure

- 1 Press the rightmost soft key  (next-menu key) on the ALL IO screen, described in Section 8.10.1.
- 2 Press soft key **[M-CARD]**.
- 3 Place the CNC in the emergency stop state.
- 4 When a memory card is inserted, the state of the memory card is displayed as shown below.

READ/PUNCH(M-CARD) O1234 N12345

CNC RAM 512K byte	Memory card 2.000M byte S- RAM
File _____ (1/ 1) SRAM0_5A. FDB 524288 byte 97/ 01/ 23	
Message	
Select : All data S 0 T0000	
EDIT **** -- EMG-- 12: 15: 00	
[FORMAT] [SAVE] [LOAD] [DELETE] []	



- 5 Press soft key **[SAVE]**.
- 6 A message prompting the user to confirm the operation is displayed. Press soft key **[EXEC]** to execute the save operation.
- 7 As the data is being saved to the card, the message "RUNNING" blinks, and the number of bytes saved is displayed in the message field.
- 8 Once all data has been saved to the card, the message "COMPLETED" is displayed in the message field, with the message "PRESS RESET KEY." displayed on the second line.
- 9 Press the RESET key. The displayed messages are cleared from the screen, and the display of the memory card state is replaced with that of the saved file.

NOTE

All CNC memory data is saved to a memory card. CNC memory data cannot be saved selectively.

Explanations

- File name**

The file name used for save operation is determined by the amount of SRAM mounted in the CNC. A file holding saved data is divided into blocks of 512KB.


HEAD1 SRAM file

Amount of SRAM	256KB	0.5 MB	1.0 MB	2.5 MB
Number of files 1	SRAM256A. FDB	SRAM0_5A. FDB	SRAM1_0A. FDB SRAM1_0B. FDB	SRAM2_5A. FDB
2				SRAM2_5B. FDB
3			SRAM2_5C. FDB	
4			SRAM2_5D. FDB	
5			SRAM2_5E. FDB	

HEAD2 SRAM file

Amount of SRAM	256KB	0.5 MB	1.0 MB	2.5 MB
Number of files 1	SRAM256A. OP2	SRAM0_5A. OP2	SRAM1_0A. OP2 SRAM1_0B. OP2	SRAM2_5A. OP2
2				SRAM2_5B. OP2
3			SRAM2_5C. OP2	
4			SRAM2_5D. OP2	
5			SRAM2_5E. OP2	

- Canceling saving**

To cancel file save prior to its completion, press the  key on the MDI panel.
- Memory card replacement request**

When the memory card has less than 512K bytes of free space, a memory card replacement request is displayed. Insert a new memory card.


Loading Data into Memory (Restoration)

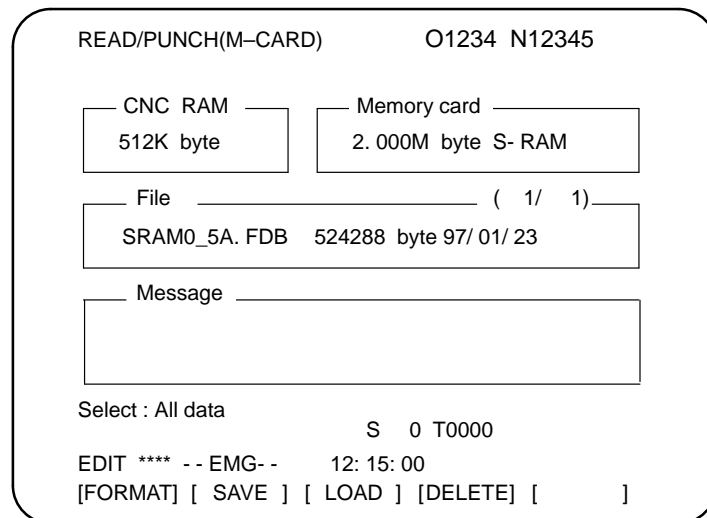
CNC memory data that has been saved to a memory card can be loaded (restored) back into CNC memory.

CNC memory data can be loaded in either of two ways. In the first method, all saved memory data is loaded. In the second method, only selected data is loaded.

Loading memory data

Procedure

- 1 Press the rightmost soft key  (next-menu key) on the ALL IO screen, described in Section 8.10.1.
- 2 Press soft key **[M-CARD]**.
- 3 Place the CNC in the emergency stop state.
- 4 When a memory card is inserted, the state of the memory card is displayed as shown below.



READ/PUNCH(M-CARD) O1234 N12345



CNC RAM 512K byte	Memory card 2.000M byte S- RAM
----------------------	-----------------------------------

File _____ (1/ 1)
SRAM0_5A. FDB 524288 byte 97/ 01/ 23

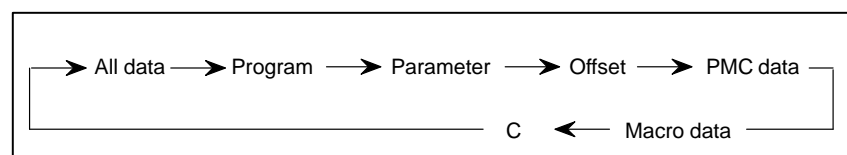
Message _____

Select : All data S 0 T0000

EDIT **** -- EMG-- 12: 15: 00
[FORMAT] [SAVE] [LOAD] [DELETE] []

- 5 Press soft key **[LOAD]**.
- 6 With cursor keys  and , select the file to be loaded from the memory card.
A system having 1.0MB or 2.5MB of CNC RAM may require the loading of multiple files. All or selective data load can be specified for each file.
- 7 To perform selective data loading, press soft key **[SELECT]**, then select the data to be loaded. Each time the soft key is pressed, the information displayed changes cyclically, as shown below.

{SELEC} { } { } {CAN} {EXEC}




- 8 After checking the file selection, press soft key **[EXEC]**.

- 9 During loading, the message "RUNNING" blinks, and the number of bytes loaded is displayed in the message field.
- 10 Upon the completion of loading, the message "COMPLETED" is displayed in the message field, with the message "PRESS RESET KEY." displayed on the second line.
- 11 Press the RESET key. The messages are cleared from the screen.

Explanations

- **Canceling loading**

To cancel file load prior to its completion, press the  key on the MDI panel.

- **Turning off the power after loading**

Depending on the type of data, the system power may have to be turned off, then back on, for the load to become effective. When necessary, the message "TURN OFF POWER." is displayed in the message field.

- **Parameter/PMC data**

Before performing parameter/PMC data load, enable parameter write.

- **Program/offset data**

Before performing program/offset data load, set the data protection key, on the machine operator's panel, to the ON position.

- **Loading files from multiple memory cards**

When multiple files are to be loaded from multiple memory cards, a message requesting memory card replacement is displayed.

NOTE

If the saved data and CNC system onto which the saved data is to be loaded do not satisfy the conditions described below, an error message is displayed in the message field, and loading is disabled. Note, however, that in selective loading, even if the CNC system structure differs from that of a saved file, the file is never the less loaded.


- The size of a saved file does not match the size of CNC RAM.
- The saved file has a different extension.

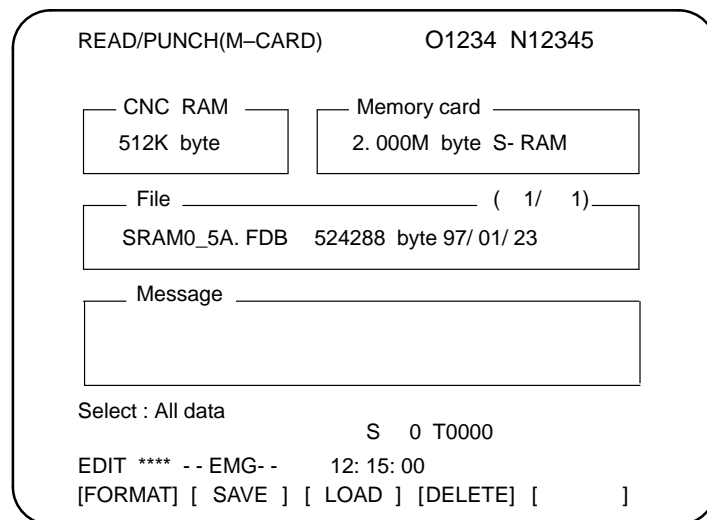
Memory card formatting

Before a file can be saved to a memory card, the memory card must be formatted.

Formatting a memory card

Procedure

- 1 Press the rightmost soft key  (next-menu key) on the ALL IO screen, described in Section 8.10.1.
- 2 Press soft key **[M-CARD]**.
- 3 Place the CNC in the emergency stop state.
- 4 When a memory card is inserted, the state of the memory card is displayed as shown below.



READ/PUNCH(M-CARD) O1234 N12345

CNC RAM 512K byte	Memory card 2.000M byte S- RAM
----------------------	-----------------------------------

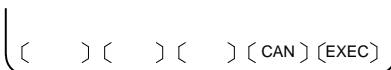
File _____ (1/ 1)
SRAM0_5A. FDB 524288 byte 97/ 01/ 23

Message _____

Select : All data S 0 T0000

EDIT **** -- EMG-- 12: 15: 00

[FORMAT] [SAVE] [LOAD] [DELETE] []



- 5 Press soft key **[FORMAT]**.
- 6 A message prompting the user to confirm the operation is displayed. Press soft key **[EXEC]** to execute the formatting operation.
- 7 As formatting is being performed, the message "FORMATTING" blinks.
- 8 Upon the completion of formatting, the message "COMPLETED" is displayed in the message field.

Messages and restrictions

Messages

Message	Description
INSERT MEMORY CARD.	No memory card is inserted.
UNUSABLE MEMORY CARD	The memory card does not contain device information.
FORMAT MEMORY CARD.	The memory card is not formatted. Format the memory card before use.
THE FILE IS UNUSABLE.	The format or extension of the file to be loaded is invalid. Alternatively, the data stored on the memory card does not match the CNC memory size.
REPLACE MEMORY CARD.	Replace the memory card.
FILE SYSTEM ERROR □□□	An error occurred during file system processing. □□□ represents a file system error code.
SET EMERGENCY STOP STATE.	Save/load operation is enabled in the emergency stop state only.
WRITE-PROTECTED	Save operation: The protect switch of the memory card is set to the disabled position. Load operation: Parameter write is disabled.
VOLTAGE DECREASED.	The battery voltage of the memory card has dropped. (The battery requires replacement.)
DEVICE IS BUSY.	Another user is using the memory card. Alternatively, the device cannot be accessed because automatic operation is in progress.
SRAM → MEMORY CARD?	This message prompts the user to confirm the start of data saving.
MEMORY CARD → SRAM?	This message prompts the user to confirm the start of data loading.
DO YOU WANT TO DELETE FILE(S)?	This message prompts the user to confirm the start of deletion.
DO YOU WANT TO PERFORM FORMATTING?	This message prompts the user to confirm the start of formatting.
SAVING	Saving is currently being performed.
LOADING	Loading is currently being performed.
DELETING	File deletion is currently being performed.
FORMATTING	Memory card formatting is currently being performed.
COMPLETED	Save or load processing has been completed.
PRESS RESET KEY.	Press the RESET key.
TURN OFF POWER.	Turn the power off, then back on again.

File system error codes

Code	Meaning
102	The memory card does not have sufficient free space.
105	No memory card is mounted.
106	A memory card is already mounted.
110	The specified directory cannot be found.
111	There are too many files under the root directory to allow a directory to be added.
114	The specified file cannot be found.
115	The specified file is protected.
117	The file has not yet been opened.
118	The file is already open.
119	The file is locked.
122	The specified file name is invalid.
124	The extension of the specified file is invalid.
129	A non-corresponding function was specified.
130	The specification of a device is invalid.
131	The specification of a pathname is invalid.
133	Multiple files are open at the same time.
135	The device is not formatted.
140	The file has the read/write disabled attribute.

Restrictions

- **Memory card size**

The size of the memory card to be used must be larger than that of the RAM module mounted in the CNC. The size of the RAM module can be determined from the system configuration screen.

- **Memory card specifications**

Use a memory card that conforms to PCMCIA Ver. 2.0, or JEIDA Ver. 4.1.

- **Attribute memory**

A memory card which has no attribute memory, or no device information in its attribute memory, cannot be used.

- **Compatibility of saved data**

Data saved to a memory card is compatible only with CNCs that have the same hardware configuration and the same option configuration.

- **Flash ROM card**

A flash ROM card can be used only for data loading.

- **Operation during automatic operation**

During automatic operation, the contents of a memory card cannot be displayed, formatted, or deleted. To enable these operations, therefore, stop or suspend automatic operation.

8.11 DATA INPUT/OUTPUT USING A MEMORY CARD

By setting the I/O channel (parameter No. 20) to 4, files on a memory card can be referenced, and different types of data such as part programs, parameters, and offset data on a memory card can be input and output in text file format.

The major functions are listed below.

- Displaying a directory of stored files

The files stored on a memory card can be displayed on the directory screen.

- Searching for a file

A search is made for a file on a memory card and, if found, it is displayed on the directory screen.

- Reading a file

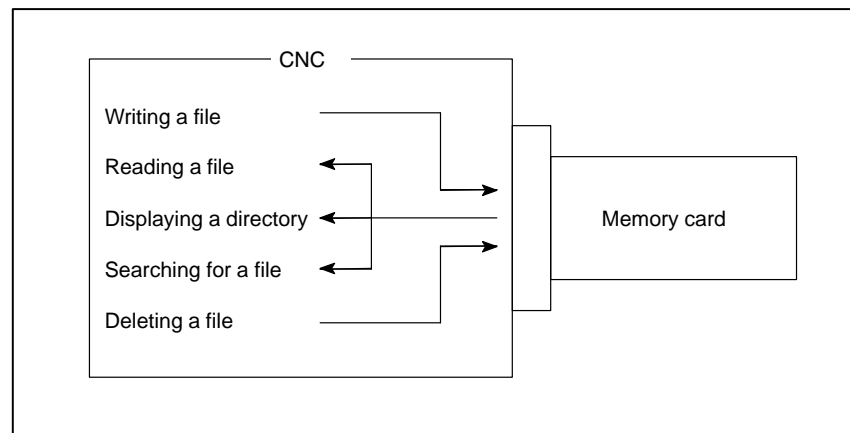
Text-format files can be read from a memory card.

- Writing a file

Data such as part programs can be stored to a memory card in text file format.





- Deleting a file

A file can be selected and deleted from a memory card.



Displaying a directory of stored files

Procedure

- 1 Press the EDIT switch on the machine operator's panel.
- 2 Press function key  .
- 3 Press the rightmost soft key  (next-menu key).
- 4 Press soft key **[CARD]**. The screen shown below is displayed. Using page keys  and , the screen can be scrolled.

DIRECTORY (M-CARD)			O0034 N00045
No.	FILE NAME	SIZE	DATE
0001	O1000	123456	96/07/10
0002	O1001	8458	96/07/30
0003	O0002	3250	96/07/30
0004	O2000	73456	96/07/31
0005	O2001	3444	96/07/31
0006	O3001	8483	96/08/02
0007	O3300	406	96/08/05
0008	O3400	2420	96/07/31
0009	O3500	7460	96/07/31

~ (PROG) () (DIR +) () (OPRT) ~

- 5 Comments relating to each file can be displayed by pressing soft key **[DIR+]**.



DIRECTORY (M-CARD)			O0034 N00045
No.	FILE NAME		COMMENT
0001	O1000		(COMMENT)
0002	O1001		(SUB PROGRAM)
0003	O0002		(12345678)
0004	O2000		()
0005	O2001		()
0006	O3001		(SKIP-K)
0007	O3300		(HI-SPEED)
0008	O3400		()
0009	O3500		(TEST PROGRAM)

~ (PROG) () (DIR +) () (OPRT) ~

- 6 Repeatedly pressing soft key **[DIR+]** toggles the screen between the display of comments and the display of sizes and dates. Any comment described after the O number in the file is displayed. Up to 18 characters can be displayed on the screen.

Searching for a file

Procedure

- 1 Press the EDIT switch on the machine operator's panel.
- 2 Press function key  .
- 3 Press the rightmost soft key  (next-menu key).
- 4 Press soft key **[CARD]**. The screen shown below is displayed.

DIRECTORY (M-CARD)			O0034 N00045
No.	FILE NAME	SIZE	DATE
0001	O1000	123456	96/07/10
0002	O1001	8458	96/07/30
0003	O0002	3250	96/07/30
0004	O2000	73456	96/07/31
0005	O2001	3444	96/07/31
0006	O3001	8483	96/08/02
0007	O3300	406	96/08/05
0008	O3400	2420	96/07/31
0009	O3500	7460	96/07/31

~ ([PROG]) ([DIR +]) ([OPRT]) ~

- 5 Press soft key **[(OPRT)]**.
- 6 Set the number of the desired file number with soft key **[F SRH]**. Then, start the search by pressing soft key **[EXEC]**. If found, the file is displayed at the top of the directory screen.

[F SRH] [F READ] [N READ] [PUNCH] [DELETE]

When a search is made for file number 19

DIRECTORY (M-CARD)		O0034 N00045
No.	FILE NAME	COMMENT
0019	O1000	(MAIN PROGRAM)
0020	O1010	(SUBPROGRAM-1)
0021	O1020	(COMMENT)
0022	O1030	(COMMENT)

~ ~

Reading a file

Procedure

- 1 Press the EDIT switch on the machine operator's panel.
- 2 Press function key PROG.
- 3 Press the rightmost soft key (next-menu key).
- 4 Press soft key **[CARD]**. Then, the screen shown below is displayed.

DIRECTORY (M-CARD)			O0034 N00045
No.	FILE NAME	SIZE	DATE
0001	O1000	123456	96/07/10
0002	O1001	8458	96/07/30
0003	O0002	3250	96/07/30
0004	O2000	73456	96/07/31
0005	O2001	3444	96/07/31
0006	O3001	8483	96/08/02
0007	O3300	406	96/08/05
0008	O3400	2420	96/07/31
0009	O3500	7460	96/07/31

[(PROG)] [()] [(DIR +)] [()] [(OPRT)]

[(F SRH)] [(F READ)] [(N READ)] [(PUNCH)] [(DELETE)]

- 5 Press soft key **[(OPRT)]**.
- 6 To specify a file number, press soft key **[F READ]**. The screen shown below is displayed.

DIRECTORY (M-CARD)		O0001 N00010
No.	FILE NAME	COMMENT
0019	O1000	(MAIN PROGRAM)
0020	O1010	(SUBPROGRAM-1)
0021	O1030	(COMMENT)

READ
 FILE NAME=20 PROGRAM No.=120
 >
 EDIT *** ***** 15:40:21
 [(F NAME)] [(O SET)] [(STOP)] [(CAN)] [(EXEC)]

- 7 Enter file number 20 from the MDI panel, then set the file number by pressing soft key **[F SET]**. Next, enter program number 120, then set the program number by pressing soft key **[O SET]**. Then, press soft key **[EXEC]**.
 - File number 20 is registered as O0120 in the CNC.
 - Set a program number to register a read file with a separate O number. If no program number is set, the O number in the file name column is registered.

- 8 To specify a file with its file name, press soft key **[N READ]** in step 6 above. The screen shown below is displayed.



DIRECTORY (M-CARD)		O0001 N00010
No.	FILE NAME	COMMENT
0012	O0050	(MAIN PROGRAM)
0013	TESTPRO	(SUB PROGRAM-1)
0014	O0060	(MACRO PROGRAM)

READ	FILE NAME =TESTPRO
	PROGRAM No. =1230
>	
EDIT	*** ***** 15:40:21
(F NAME)	(O SET)
(STOP)	(CAN)
(EXEC)	

- 9 To register file name TESTPRO as O1230, enter file name TESTPRO from the MDI panel, then set the file name with soft key **[F NAME]**. Next, enter program number 1230, then set the program number with soft key **[O SET]**. Then, press soft key **[EXEC]**.

Writing a file

Procedure

- 1 Press the EDIT switch on the machine operator's panel.
- 2 Press function key  .
- 3 Press the rightmost soft key  (next-menu key).
- 4 Press soft key **[CARD]**. The screen shown below is displayed.

DIRECTORY (M-CARD)			O0034 N00045
No.	FILE NAME	SIZE	DATE
0001	O1000	123456	96/07/10
0002	O1001	8458	96/07/30
0003	O0002	3250	96/07/30
0004	O2000	73456	96/07/31
0005	O2001	3444	96/07/31
0006	O3001	8483	96/08/02
0007	O3300	406	96/08/05
0008	O3400	2420	96/07/31
0009	O3500	7460	96/07/31

~ (PROG) () (DIR +) () (OPRT) ~

(F SRH) (F READ) (N READ) (PUNCH) (DELETE)

- 5 Press soft key **[(OPRT)]**.
- 6 Press soft key **[PUNCH]**.
- 7 Enter a desired O number from the MDI panel, then set the program number with soft key **[O SET]**.
When soft key **[EXEC]** is pressed after the setting shown below has been made, for example, the file is written under program number O1230.

```

PUNCH          FILE NAME =
                PROGRAM No. =1230
>
EDIT *** **** * 15:40:21
( F NAME ) ( O SET ) ( STOP ) ( CAN ) ( EXEC )

```

- 8 In the same way as for O number setting, enter a desired file name from the MDI panel, then set the file name with soft key **[F SET]**.
When soft key **[EXEC]** is pressed after the setting shown below has been made, for example, the file is written under program number O1230 and file name ABCD12.

```

PUNCH          FILE NAME =ABCD12
                PROGRAM No. =1230
>
EDIT *** **** * 15:40:21
( F NAME ) ( O SET ) ( STOP ) ( CAN ) ( EXEC )

```

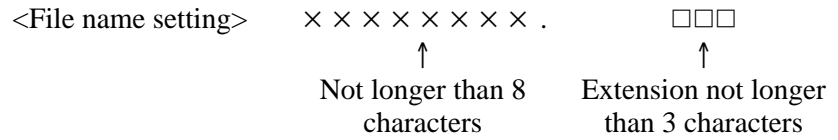

Explanations

- **Registering the same file name**
- **Writing all programs**
- **File name restrictions**

When a file having the same name is already registered in the memory card, the existing file will be overwritten.



To write all programs, set program number = -9999. If no file name is specified in this case, file name PROGRAM.ALL is used for registration.

The following restrictions are imposed on file name setting:



Deleting a file

Procedure

- 1 Press the EDIT switch on the machine operator's panel.
- 2 Press function key  .
- 3 Press the rightmost soft key  (next-menu key).
- 4 Press soft key **[CARD]**. The screen shown below is displayed.

DIRECTORY (M-CARD)			O0034 N00045
No.	FILE NAME	SIZE	DATE
0001	O1000	123456	96/07/10
0002	O1001	8458	96/07/30
0003	O0002	3250	96/07/30
0004	O2000	73456	96/07/31
0005	O2001	3444	96/07/31
0006	O3001	8483	96/08/02
0007	O3300	406	96/08/05
0008	O3400	2420	96/07/31
0009	O3500	7460	96/07/31

~ ([PROG]) ([DIR +]) ([OPRT]) ~

- 5 Press soft key **[(OPRT)]**.
- 6 Set the number of the desired file with soft key **[DELETE]**, then press soft key **[EXEC]**. The file is deleted, and the directory screen is displayed again.

{ F SRH } { F READ } { N READ } { PUNCH } { DELETE }

When file number 21 is deleted

DIRECTORY (M-CARD)			O0034 N00045
No.	FILE NAME		COMMENT
0019	O1000		(MAIN PROGRAM)
0020	O1010		(SUBPROGRAM-1)
0021	O1020		(COMMENT)
0022	O1030		(COMMENT)

~

File name O1020 is deleted.

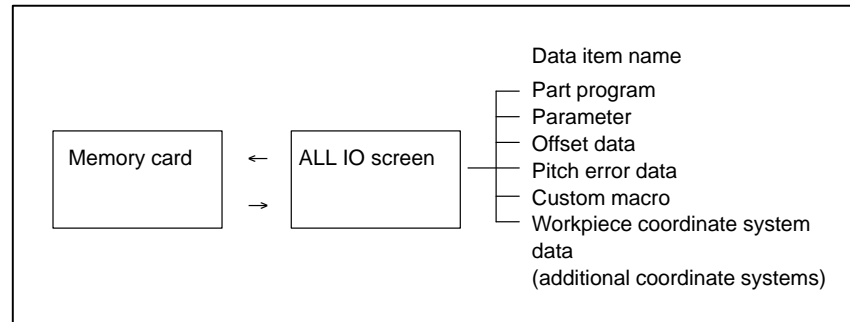
DIRECTORY (M-CARD)			O0034 N00045
No.	FILE NAME		COMMENT
0019	O1000		(MAIN PROGRAM)
0020	O1010		(SUBPROGRAM-1)
0021	O1020		(COMMENT)
0022	O1030		(COMMENT)

~



File number 21 is assigned to the next file name.

Batch input/output with a memory card

On the ALL IO screen, different types of data including part programs, parameters, offset data, pitch error data, custom macros, and workpiece coordinate system data can be input and output using a memory card; the screen for each type of data need not be displayed for input/output.





Procedure


- 1 Press the EDIT switch on the machine operator's panel.
- 2 Press function key  .
- 3 Press the rightmost soft key  (next-menu key) several times.
- 4 Press soft key **[ALL IO]**. The screen shown below is displayed.

READ/PUNCH (PROGRAM)						O0001 N0001
No.	FILE NAME	SIZE				DATE
*0001	O0222	332010				96-04-06
*0002	O1003	334450				96-05-04
*0003	MACROVAR.DAT	653400				96-05-12
*0004	O0002	341205				96-05-13
[PROGRAM]						
*O0001	O0002	O0003	O0005	O0100	O0020	
*O0006	O0004	O0110	O0200	O2200	O0441	
*O0330						
>						
EDIT	***	****	***	****	10:07:37	
(PROG)	(PARAM)	(OFFSET)	()	(OPRT))



Upper part : Directory of files on the memory card

Lower part : Directory of registered programs

- 5 With cursor keys  and  , the user can choose between upper part scrolling and lower part scrolling. (An asterisk (*) displayed at the left edge indicates the part for which scrolling is possible.)


 : Used for memory card file directory scrolling.

 : Used for program directory scrolling.

- 6 With page keys  and  , scroll through the file directory or program directory.

Explanations

- **Each data item**

When this screen is displayed, the program data item is selected. The soft keys for other screens are displayed by pressing the rightmost soft key  (next-menu key). Soft key **[M-CARD]** represents a separate memory card function for saving and restoring system RAM data. (See Sections 8.10.7 and Section NO TAG.)

(MACRO) (PITCH) (WORK) () (OPRT)

() () () (M-CARD) (OPRT)

When a data item other than program is selected, the screen displays only a file directory.

A data item is indicated, in parentheses, on the title line.

READ/PUNCH (PARAMETER)		O0001 N0001	
No.	FILE NAME	SIZE	DATE
0001	O0222	32010	96/04/06
0002	O1003	4450	96/05/04
0003	MACROVAR.DAT	653400	96/05/12
0004	O0003	4610	96/05/04
0005	O0001	4254	96/06/04
0006	O0002	750	96/06/04
0007	CNCPARAM.DAT	34453	96/06/04

- **Program directory display**

Program directory display does not match bit 0 (NAM) of parameter No. 3107, or bit 4 (SOR) of parameter No. 3107.

- **Using each function**

Display the following soft keys with soft key **[(OPRT)]**.

(F SRH) (F READ) (N READ) (PUNCH) (DELETE)

The operation of each function is the same as on the directory (memory card) screen. Soft key **[O SET]**, used for program number setting, and the "PROGRAM NUMBER =" indication are not displayed for data items other than program.

[F SRH] : Finds a specified file number.

[F READ] : Reads a specified file number.

[PUNCH] : Writes a file.

[N READ] : Reads a file under a specified file name.

[DELETE] : Deletes a specified file number.

NOTE

With a memory card, RMT mode operation and the subprogram call function (based on the M198 command) cannot be used.

File format and error messages

Format

All files that are read from and written to a memory card are of text format. The format is described below.

A file starts with % or LF, followed by the actual data. A file always ends with %. In a read operation, data between the first % and the next LF is skipped. Each block ends with an LF, not a semicolon (;).

- LF: 0A (hexadecimal) of ASCII code
- When a file containing lowercase letters, kana characters, and several special characters (such as \$, \, and !) is read, those letters and characters are ignored.

Example:

```
%
O0001(MEMORY CARD SAMPLE FILE)
G17 G49 G97
G92 X-11.3 Y2.33
.
.
M30
%
```

- ASCII code is used for input/output, regardless of the setting parameter (ISO/EIA).
- Bit 3 of parameter No. 0100 can be used to specify whether the end of block code (EOB) is output as "LF" only, or as "LF, CR, CR."

Error messages

If an error occurs during memory card input/output, a corresponding error message is displayed.

```

~
0028  O0003                               7382  96-06-14
M-CARD ERROR                               × × × ×
FILE No. =          1          PROGRAM No. =13
>_
EDIT  ***  ****  ***  ****                15:40:21
( F SET ) ( O SET ) ( STOP ) ( CAN ) ( EXEC )
~

```

× × × × represents a memory card error code.

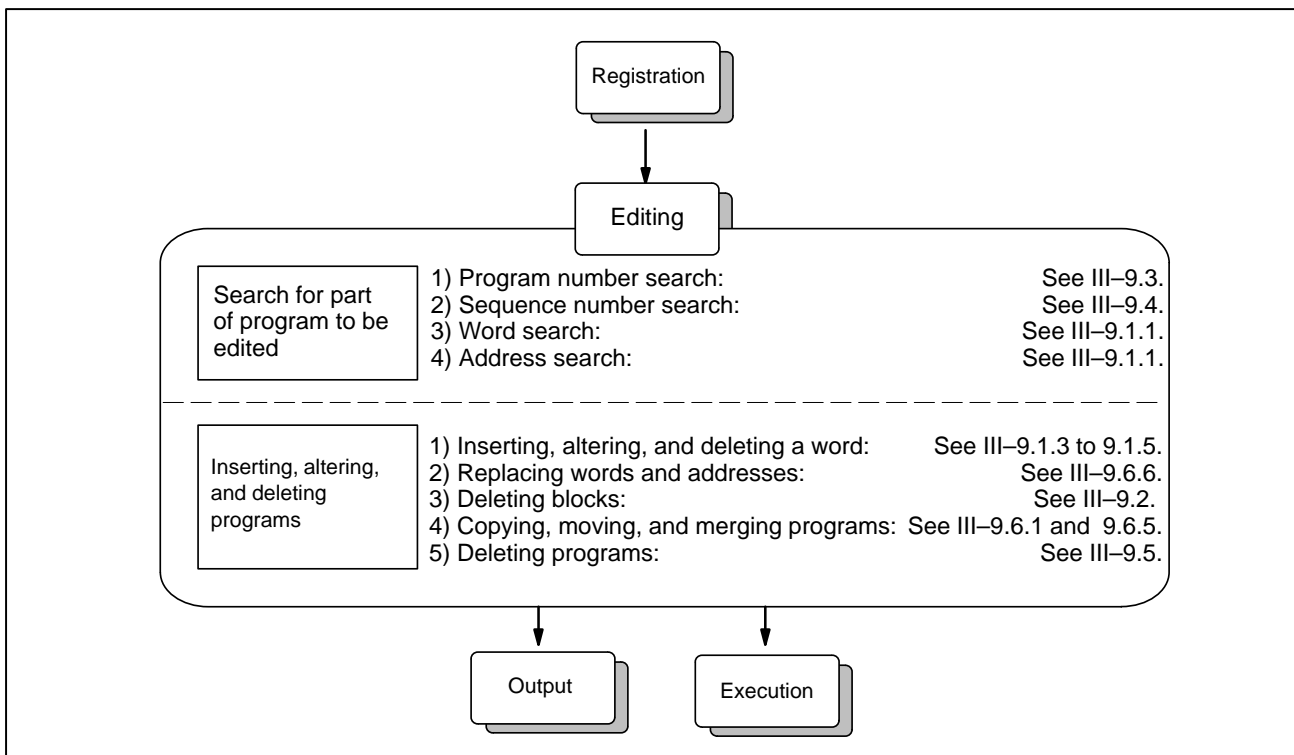
**Memory Card Error
Codes**

Code	Meaning
102	The memory card does not have sufficient free space.
105	No memory card is mounted.
106	A memory card is already mounted.
110	The specified directory cannot be found.
111	There are too many files under the root directory to allow a directory to be added.
114	The specified file cannot be found.
115	The specified file is protected.
117	The file has not yet been opened.
118	The file is already open.
119	The file is locked.
122	The specified file name is invalid.
124	The extension of the specified file is invalid.
129	A non-corresponding function was specified.
130	The specification of a device is invalid.
131	The specification of a pathname is invalid.
133	Multiple files are open at the same time.
135	The device is not formatted.
140	The file has the read/write disabled attribute.

9 EDITING PROGRAMS

General


This chapter describes how to edit programs registered in the CNC. Editing includes the insertion, modification, deletion, and replacement of words. Editing also includes deletion of the entire program and automatic insertion of sequence numbers. The extended part program editing function can copy, move, and merge programs. This chapter also describes program number search, sequence number search, word search, and address search, which are performed before editing the program.



9.1 INSERTING, ALTERING AND DELETING A WORD

This section outlines the procedure for inserting, modifying, and deleting a word in a program registered in memory.

Procedure for inserting, altering and deleting a word

- 1 Select **EDIT** mode.
- 2 Press  .
- 3 Select a program to be edited.
If a program to be edited is selected, perform the operation 4.
If a program to be edited is not selected, search for the program number.
- 4 Search for a word to be modified.
 - Scan method
 - Word search method
- 5 Perform an operation such as altering, inserting, or deleting a word.

Explanation

- **Concept of word and editing unit**

A word is an address followed by a number. With a custom macro, the concept of word is ambiguous.

So the editing unit is considered here.

The editing unit is a unit subject to alteration or deletion in one operation.

In one scan operation, the cursor indicates the start of an editing unit.

An insertion is made after an editing unit.

Definition of editing unit

(i) Program portion from an address to immediately before the next address

(ii) An address is an alphabet, **IF**, **WHILE**, **GOTO**, **END**, **DO=**, or ; (**EOB**).
According to this definition, a word is an editing unit.

The word “word,” when used in the description of editing, means an editing unit according to the precise definition.


WARNING

The user cannot continue program execution after altering, inserting, or deleting data of the program by suspending machining in progress by means of an operation such as a single block stop or feed hold operation during program execution. If such a modification is made, the program may not be executed exactly according to the contents of the program displayed on the screen after machining is resumed. So, when the contents of memory are to be modified by part program editing, be sure to enter the reset state or reset the system upon completion of editing before executing the program.


9.1.1 Word Search

A word can be searched for by merely moving the cursor through the text (scanning), by word search, or by address search.

Procedure for scanning a program

- 1 Press the cursor key .

The cursor moves forward word by word on the screen; the cursor is displayed at a selected word.











- 2 Press the cursor key .

The cursor moves backward word by word on the screen; the cursor is displayed at a selected word.

Example) When Z1250.0 is scanned

```

Program                                O0050 N01234
O0050 ;
N01234 X100.0 Z1250.0 ;
S12 ;
N56789 M03 ;
M02 ;
%
```

- 3 Holding down the cursor key  or  scans words continuously.
- 4 The first word of the next block is searched for when the cursor key  is pressed.
- 5 The first word of the previous block is searched for when the cursor key  is pressed.
- 6 Holding down the cursor key  or  moves the cursor to the head of a block continuously.
- 7 Pressing the page key  displays the next page and searches for the first word of the page.
- 8 Pressing the page key  displays the previous page and searches for the first word of the page.
- 9 Holding down the page key  or  displays one page after another.

Procedure for searching a word

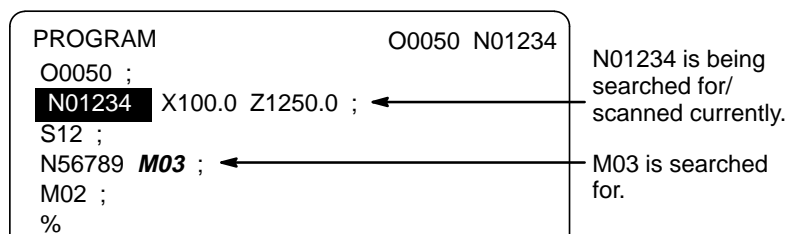
Example) of Searching for S12



- 1 Key in address S .
- 2 Key in 1 2 .
 - S12 cannot be searched for if only S1 is keyed in.
 - S09 cannot be searched for by keying in only S9.
 - To search for S09, be sure to key in S09.
- 3 Pressing the **[SRH↓]** key starts search operation. Upon completion of search operation, the cursor is displayed at S12. Pressing the **[SRH↑]** key rather than the **[SRH↓]** key performs search operation in the reverse direction.

Procedure for searching an address

Example) of Searching for M03



- 1 Key in address M .
- 2 Press the **[SRH↓]** key. Upon completion of search operation, the cursor is displayed at M03. Pressing the **[SRH↑]** key rather than the **[SRH↓]** key performs search operation in the reverse direction.

Alarm


Alarm number	Description
71	The word or address being searched for was not found.

9.1.2 Heading a Program

The cursor can be jumped to the top of a program. This function is called heading the program pointer. This section describes the three methods for heading the program pointer.


Procedure for Heading a Program

Method 1


- 1 Press  when the program screen is selected in EDIT mode. When the cursor has returned to the start of the program, the contents of the program are displayed from its start on the screen.

Method 2

Search for the program number.


- 1 Press address , when a program screen is selected in the **MEMORY** or **EDIT** mode.
- 2 Input a program number.
- 3 Press the soft key **[O SRH]**.

Method 3

- 1 Select **[MEMORY]** or **[EDIT]** mode.
- 2 Press .
- 3 Press the **[(OPRT)]** key.
- 4 Press the **[REWIND]** key.

9.1.3 Inserting a Word

Procedure for inserting a word

- 1 Search for or scan the word immediately before a word to be inserted.
- 2 Key in an address to be inserted.
- 3 Key in data.
- 4 Press the  key.


Example of Inserting T15

Procedure

- 1 Search for or scan Z1250.

<pre> Program O0050 N01234 O0050 ; N01234 X100.0 Z1250.0 ; ← S12 ; N56789 M03 ; M02 ; %</pre>	Z1250.0 is searched for/ scanned.
---	---


- 2 Key in    .

- 3 Press the  key.

<pre> Program O0050 N01234 O0050 ; N01234 X100.0 Z1250.0 T15 ; ← S12 ; N56789 M03 ; M02 ; %</pre>	T15 is inserted.
---	------------------

9.1.4 Altering a Word

Procedure for altering a word

- 1 Search for or scan a word to be altered.
- 2 Key in an address to be inserted.
- 3 Key in data.
- 4 Press the  key.




Example of changing T15 to M15


Procedure

- 1 Search for or scan T15.

```

Program                                O0050 N01234
O0050 ;
N01234 X100.0 Z1250.0 T15 ; ← T15 is searched
S12 ;                                  for/scanned.
N56789 M03 ;
M02 ;
%
```

- 2 Key in    .


- 3 Press the  key.

```

Program                                O0050 N01234
O0050 ;
N1234 X100.0 Z1250.0 M15 ; ← T15 is changed to
S12 ;                                  M15.
N5678 M03 ;
M02 ;
%
```

9.1.5 Deleting a Word

Procedure for deleting a word


- 1 Search for or scan a word to be deleted.
- 2 Press the  key.

Example of deleting X100.0

Procedure

- 1 Search for or scan X100.0.

<pre> Program O0050 N01234 O0050 ; N01234 X100.0 Z1250.0 M15 ; ← S12 ; N56789 M03 ; M02 ; %</pre>	<p>X100.0 is searched for/ scanned.</p>
--	---

- 2 Press the  key.

<pre> Program O0050 N01234 O0050 ; N01234 Z1250.0 M15 ; ← S12 ; N56789 M03 ; M02 ; %</pre>	<p>X100.0 is deleted.</p>
---	---------------------------

9.2 DELETING BLOCKS

A block or blocks can be deleted in a program.

9.2.1 Deleting a Block

The procedure below deletes a block up to its EOB code; the cursor advances to the address of the next word.

Procedure for deleting a block

- 1 Search for or scan address N for a block to be deleted.
- 2 Key in .
- 3 Press the .

Example of deleting a block of N01234

Procedure

- 1 Search for or scan N01234.

```

Program                                O0050 N01234
O0050 ;
N01234 Z1250.0 M15 ; ← N01234 is
S12 ;                                  searched for/
N56789 M03 ;                          scanned.
M02 ;
%
```

- 2 Key in .
- 3 Press the key.

```

Program                                O0050 N01234
O0050 ; ← Block containing
S12 ;                                  N01234 has
N56789 M03 ;                          been deleted.
M02 ;
%
```

9.2.2 Deleting Multiple Blocks

The blocks from the currently displayed word to the block with a specified sequence number can be deleted.

Procedure for deleting multiple blocks

- 1 Search for or scan a word in the first block of a portion to be deleted.
- 2 Key in address N .
- 3 Key in the sequence number for the last block of the portion to be deleted.
- 4 Press the DELETE key.

Example of deleting blocks from a block containing N01234 to a block containing N56789

Procedure

- 1 Search for or scan N01234.

```

Program                                O0050 N01234
O0050 ;
N01234 Z1250.0 M15 ; ← N01234 is
S12 ;                                  searched for/
N56789 M03 ;                           scanned.
M02 ;
%
```

- 2 Key in N 5 6 7 8 9 .

```

Program                                O0050 N01234
O0050 ;
N01234 Z1250.0 M15 ; } ← Underlined
S12 ;                                  part is de-
N56789 M03 ;                           leted.
M02 ;
%
```

- 3 Press the DELETE key.




```

Program                                O0050 N01234
O0050 ; ← Blocks from block
M02 ;                                  containing
%                                       N01234 to block
                                       containing
                                       N56789 have
                                       been deleted.
```


9.3 PROGRAM NUMBER SEARCH

When memory holds multiple programs, a program can be searched for. There are three methods as follows.

Procedure for program number search

- Method 1**
- 1 Select **EDIT** or **MEMORY** mode.
 - 2 Press  to display the program screen.
 - 3 Key in address  .
 - 4 Key in a program number to be searched for.
 - 5 Press the **[O SRH]** key.
 - 6 Upon completion of search operation, the program number searched for is displayed in the upper-right corner of the CRT screen
If the program is not found , P/S alarm No. 71 occurs.
- Method 2**
- 1 Select **EDIT** or **MEMORY** mode.
 - 2 Press  to display the program screen.
 - 3 Press the **[O SRH]** key.
In this case, the next program in the directory is searched for .
- Method 3**
- This method searches for the program number (0001 to 0015) corresponding to a signal on the machine tool side to start automatic operation. Refer to the relevant manual prepared by the machine tool builder for detailed information on operation.
- 1 Select **MEMORY** mode.
 - 2 Set the reset state(*1)
·The reset state is the state where the LED for indicating that automatic operation is in progress is off. (Refer to the relevant manual of the machine tool builder.)
 - 3 Set the program number selection signal on the machine tool side to a number from 01 to 15.
· If the program corresponding to a signal on the machine tool side is not registered, P/S alarm (No. 059) is raised.
 - 4 Press the cycle start button.
· When the signal on the machine tool side represents 00, program number search operation is not performed.

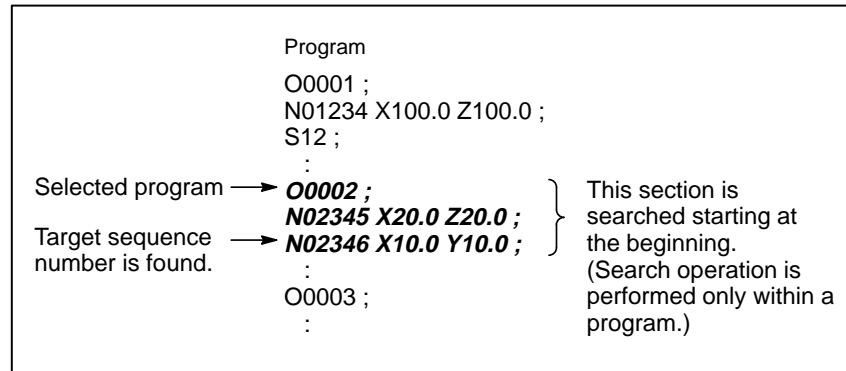
Alarm

No.	Contents
59	The program with the selected number cannot be searched during external program number search.
71	The specified program number was not found during program number search.

9.4 SEQUENCE NUMBER SEARCH

Sequence number search operation is usually used to search for a sequence number in the middle of a program so that execution can be started or restarted at the block of the sequence number.

Example) Sequence number 02346 in a program (O0002) is searched for.



Procedure for sequence number search

- 1 Select **MEMORY** mode.
- 2 Press .
- 3 · If the program contains a sequence number to be searched for, perform the operations 4 to 7 below.
 - If the program does not contain a sequence number to be searched for, select the program number of the program that contains the sequence number to be searched for.
- 4 Key in address .
- 5 Key in a sequence number to be searched for.
- 6 Press the **[N SRH]** key.
- 7 Upon completion of search operation, the sequence number searched for is displayed in the upper-right corner of the CRT screen. If the specified sequence number is not found in the program currently selected, P/S alarm No. 060 occurs.

Explanations

- **Operation during Search**

Those blocks that are skipped do not affect the CNC. This means that the data in the skipped blocks such as coordinates and M, S, and T codes does not alter the CNC coordinates and modal values.

So, in the first block where execution is to be started or restarted by using a sequence number search command, be sure to enter required M, S, and T codes and coordinates. A block searched for by sequence number search usually represents a point of shifting from one process to another. When a block in the middle of a process must be searched for to restart execution at the block, specify M, S, and T codes, G codes, coordinates, and so forth as required from the MDI after closely checking the machine tool and NC states at that point.

- **Checking during search**

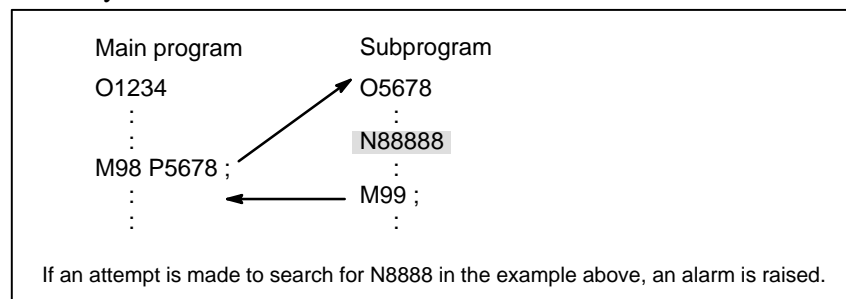
During search operation, the following checks are made:

- Optional block skip
- P/S alarm (No. 003 to 010)

Limitations

- **Searching in sub-program**

During sequence number search operation, M98Pxxxx (subprogram call) is not executed. So a P/S alarm (No.060) is raised if an attempt is made to search for a sequence number in a subprogram called by the program currently selected.



Alarm

Number	Contents
60	Command sequence number was not found in the sequence number search.




9.5 DELETING PROGRAMS

Programs registered in memory can be deleted, either one program by one program or all at once. Also, More than one program can be deleted by specifying a range.

9.5.1 Deleting One Program

A program registered in memory can be deleted.




Procedure for deleting one program

- 1 Select the **EDIT** mode.
- 2 Press  to display the program screen.
- 3 Key in address  .
- 4 Key in a desired program number.
- 5 Press the  key.
The program with the entered program number is deleted.

9.5.2 Deleting All Programs

All programs registered in memory can be deleted.



Procedure for deleting all programs

- 1 Select the **EDIT** mode.
- 2 Press  to display the program screen.
- 3 Key in address  .
- 4 Key in -9999.
- 5 Press edit key  to delete all programs.

9.5.3 Deleting More Than One Program by Specifying a Range

Programs within a specified range in memory are deleted.

Procedure for deleting more than one program by specifying a range

- 1 Select the **EDIT** mode.
- 2 Press  to display the program screen.
- 3 Enter the range of program numbers to be deleted with address and numeric keys in the following format:
OXXXX,OYYYY
where XXXX is the starting number of the programs to be deleted and YYYYY is the ending number of the programs to be deleted.
- 4 Press edit key  to delete programs No. XXXX to No. YYYYY.

9.6 EXTENDED PART PROGRAM EDITING FUNCTION

With the extended part program editing function, the operations described below can be performed using soft keys for programs that have been registered in memory.

Following editing operations are available :

- All or part of a program can be copied or moved to another program.
- One program can be merged at free position into other programs.
- A specified word or address in a program can be replaced with another word or address.

9.6.1 Copying an Entire Program

A new program can be created by copying a program.

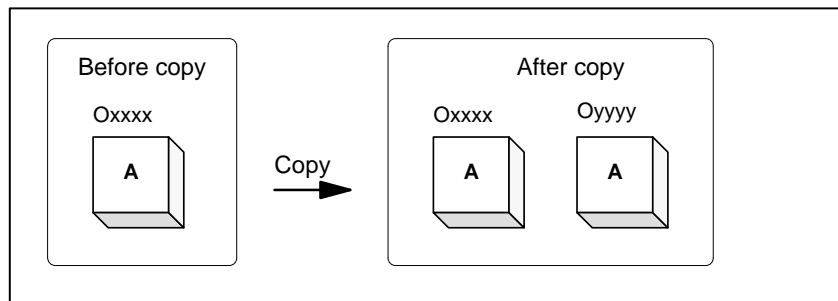


Fig. 9.6.1 Copying an Entire Program

In Fig. 9.6.1, the program with program number xxxx is copied to a newly created program with program number yyyy. The program created by copy operation is the same as the original program except the program number.

Procedure of copying an entire program

1 Enter the **EDIT** mode.

2 Press function key **PROG** .

3 Press soft key **[(OPRT)]**.

4 Press the continuous menu key.

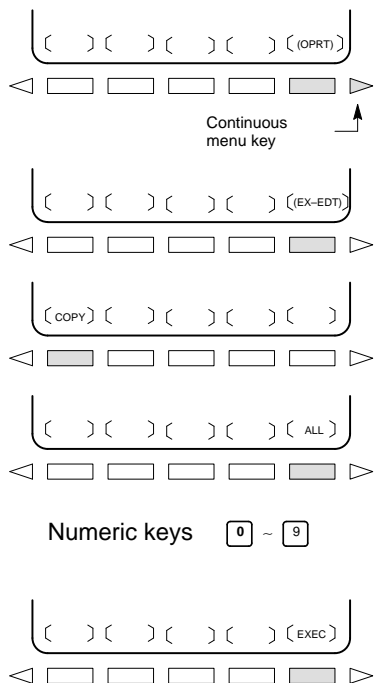
5 Press soft key **[EX-EDT]**.

6 Check that the screen for the program to be copied is selected and press soft key **[COPY]**.

7 Press soft key **[ALL]**.

8 Enter the number of the new program (with only numeric keys) and press the **INPUT** key.

9 Press soft key **[EXEC]**.



9.6.2 Copying Part of a Program

A new program can be created by copying part of a program.

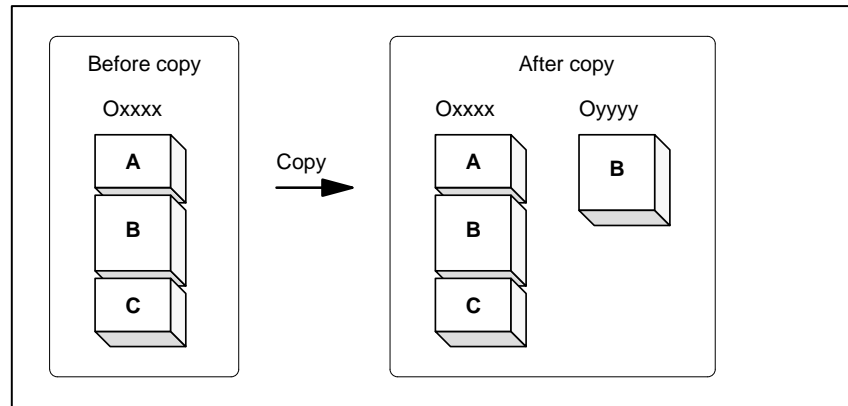


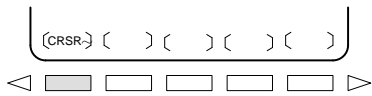
Fig. 9.6.2 Copying Part of a Program

In Fig. 9.6.2, part B of the program with program number xxxx is copied to a newly created program with program number yyyy. The program for which an editing range is specified remains unchanged after copy operation.

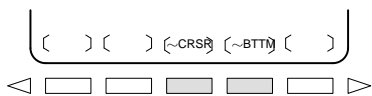
Procedure for copying part of a program

1 Perform steps 1 to 6 in III-9.6.1.

2 Move the cursor to the start of the range to be copied and press soft key [CRSR~].



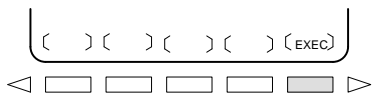
3 Move the cursor to the end of the range to be copied and press soft key [~CRSR] or [~BTM] (in the latter case, the range to the end of the program is copied regardless of the position of the cursor).



4 Enter the number of the new program (with only numeric keys) and press the [INPUT] key.

Numeric keys [0] ~ [9]

5 Press soft key [EXEC].



9.6.3 Moving Part of a Program

A new program can be created by moving part of a program.

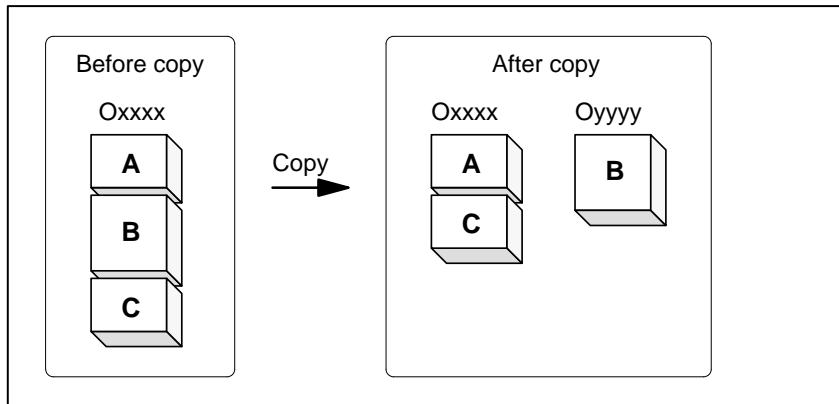
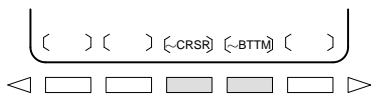
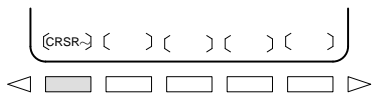
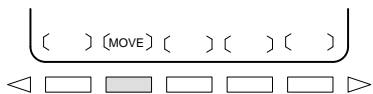


Fig. 9.6.3 Moving Part of a Program

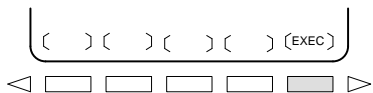
In Fig. 9.6.3, part B of the program with program number xxxx is moved to a newly created program with program number yyyy; part B is deleted from the program with program number xxxx.

Procedure for moving part of a program

- 1 Perform steps 1 to 5 in III-9.6.1.
- 2 Check that the screen for the program to be moved is selected and press soft key **[MOVE]**.
- 3 Move the cursor to the start of the range to be moved and press soft key **[CRSR~]**.
- 4 Move the cursor to the end of the range to be moved and press soft key **[~CRSR]** or **[~BTTM]**(in the latter case, the range to the end of the program is copied regardless of the position of the cursor).
- 5 Enter the number of the new program (with only numeric keys) and press the key.
- 6 Press soft key **[EXEC]**.



Numeric keys ~



9.6.4 Merging a Program

Another program can be inserted at an arbitrary position in the current program.

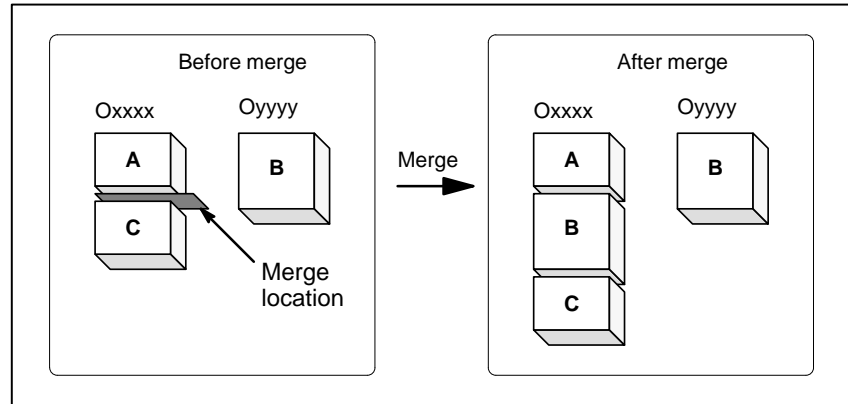
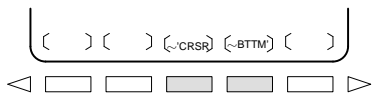
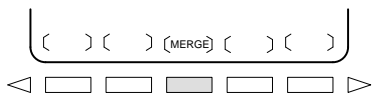


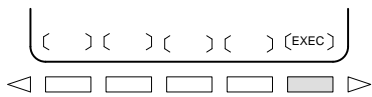
Fig. 9.6.4 Merging a program at a specified location

In Fig. 9.6.4, the program with program number XXXX is merged with the program with program number YYYYY. The OYYYY program remains unchanged after merge operation.

Procedure for merging a program



Numeric keys ~



- 1 Perform steps 1 to 5 in III-9.6.1.
- 2 Check that the screen for the program to be edited is selected and press soft key **[MERGE]**.
- 3 Move the cursor to the position at which another program is to be inserted and press soft key **[~CRSR]** or **[~BTM]** (in the latter case, the end of the current program is displayed).
- 4 Enter the number of the program to be inserted (with only numeric keys) and press the key.
- 5 Press soft key **[EXEC]**.
The program with the number specified in step 4 is inserted before the cursor positioned in step 3.

9.6.5 Supplementary Explanation for Copying, Moving and Merging

Explanations

- **Setting an editing range**

The setting of an editing range start point with [**CRSR~**] can be changed freely until an editing range end point is set with [**~CRSR**] or [**~BTM**]. If an editing range start point is set after an editing range end point, the editing range must be reset starting with a start point.


The setting of an editing range start point and end point remains valid until an operation is performed to invalidate the setting.

One of the following operations invalidates a setting:

- An edit operation other than address search, word search/scan, and search for the start of a program is performed after a start point or end point is set.
- Processing is returned to operation selection after a start point or end point is set.

- **Without specifying a program number**

In copying program and moving program, if [**EXEC**] is pressed without specifying a program number after an editing range end point is set, a program with program number O0000 is registered as a work program. This O0000 program has the following features:

- The program can be edited in the same way as a general program. (Do not run the program.)
- If a copy or move operation is newly performed, the previous information is deleted at execution time, and newly set information (all or part of the program) is reregistered. (In merge operation, the previous information is not deleted.) However, the program, when selected for foreground operation, cannot be reregistered in the background. (A BP/S alarm No. 140 is raised.) When the program is reregistered, a free area is produced. Delete such a free area with the  key.
- When the program becomes unnecessary, delete the program by a normal editing operation.

- **Editing when the system waiting for a program number to be entered**



When the system is waiting for a program number to be entered, no edit operation can be performed.

Limitations

- **Number of digits for program number**

If a program number is specified by 5 or more digits, a format error is generated.

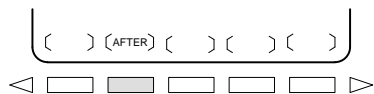
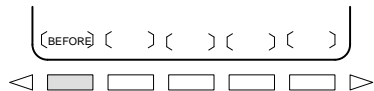
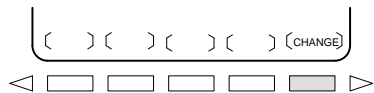
Alarm

Alarm no.	Contents
70	Memory became insufficient while copying or inserting a program. Copy or insertion is terminated.
101	The power was interrupted during copying, moving, or inserting a program and memory used for editing must be cleared. When this alarm occurs, press the key  while pressing function key  . Only the program being edited is deleted.

9.6.6 Replacement of Words and Addresses

Replace one or more specified words.
Replacement can be applied to all occurrences or just one occurrence of specified words or addresses in the program.

Procedure for change of words or addresses



- 1 Perform steps 1 to 5 in III-9.6.1.
- 2 Press soft key **[CHANGE]**.
- 3 Enter the word or address to be replaced.
- 4 Press soft key **[BEFORE]**.
- 5 Enter the new word or address.
- 6 Press soft key **[AFTER]**.
- 7 Press soft key **[EXEC]** to replace all the specified words or addresses after the cursor.
Press soft key **[1-EXEC]** to search for and replace the first occurrence of the specified word or address after the cursor.
Press soft key **[SKIP]** to only search for the first occurrence of the specified word or address after the cursor.

Examples

- Replace X100 with Y200

[CHANGE] X 1 0 0 [BEFORE] Y 2 0 0
[AFTER][EXEC]

- Replace X100Y200 with X30

[CHANGE] X 1 0 0 Y 2 0 0 [BEFORE]
X 3 0 [AFTER][EXEC]

- Replace IF with WHILE

[CHANGE] I F [BEFORE] W H I L E [AFTER]
[EXEC]

- Replace X with ,C10

[CHANGE] X [BEFORE] , C 1 0 [AFTER][EXEC]

Explanation

- **Replacing custom macros**

The following custom macro words are replaceable:
IF, WHILE, GOTO, END, DO, BPRNT, DPRINT, POPEN, PCLOS
The abbreviations of custom macro words can be specified.
When abbreviations are used, however, the screen displays the abbreviations as they are key input, even after soft key **[BEFORE]** and **[AFTER]** are pressed.

Restrictions

- **The number of characters for replacement**

Up to 15 characters can be specified for words before or after replacement.
(Sixteen or more characters cannot be specified.)

- **The characters for replacement**

Words before or after replacement must start with a character representing an address.(A format error occurs.)

9.7 EDITING OF CUSTOM MACROS

Unlike ordinary programs, custom macro programs are modified, inserted, or deleted based on editing units.

Custom macro words can be entered in abbreviated form.

Comments can be entered in a program.

Refer to the III-10.1 for the comments of a program.

Explanations

- **Editing unit**

When editing a custom macro already entered, the user can move the cursor to each editing unit that starts with any of the following characters and symbols:

- (a) Address
- (b) # located at the start of the left side of a substitution statement
- (c) /, (=, and ;
- (d) First character of IF, WHILE, GOTO, END, DO, POPEN, BPRNT, DPRNT and PCLOS

On the CRT screen, a blank is placed before each of the above characters and symbols.

(Example) Head positions where the cursor is placed

```

N001 X-#100.;
#1 =123.;
N002 /2 X[12/#3].;
N003 X-SQRT[#3/3*[#4+1]].;
N004 X-#2 Z#1.;
N005 #5 =1+2-#10.;
IF[#1NE0] GOTO10.;
WHILE[#2LE5] DO1.;
#[200+#2] =#2*10.;
#2 =#2+1.;
END1.;

```

- **Abbreviations of custom macro word**

When a custom macro word is altered or inserted, the first two characters or more can replace the entire word.

Namely,

WHILE → WH	GOTO → GO	XOR → XO	AND → AN
SIN → SI	ASIN → AS	COS → CO	ACOS → AC
TAN → TA	ATAN → AT	SQRT → SQ	ABS → AB
BCD → BC	BIN → BI	FIX → FI	FUP → FU
ROUND → RO	END → EN	EXP → EX	THEN → TH
POPEN → PO	BPRNT → BP	DPRNT → DP	PCLOS → PC

(Example) Keying in

```
WH [AB [#2 ] LE RO [#3 ] ]
```

has the same effect as

```
WHILE [ABS [#2 ] LE ROUND [#3 ] ]
```

The program is also displayed in this way.


9.8 BACKGROUND EDITING

Editing a program while executing another program is called background editing. The method of editing is the same as for ordinary editing (foreground editing).

A program edited in the background should be registered in foreground program memory by performing the following operation:

During background editing, all programs cannot be deleted at once.

Procedure for background editing

- 1 Enter **EDIT** or **MEMORY** mode.
Memory mode is allowed even while the program is being executed.
- 2 Press function key  .
- 3 Press soft key **[(OPRT)]**, then press soft key **[BG-EDT]**.
The background editing screen is displayed (PROGRAM (BG-EDIT) is displayed at the top left of the screen).
- 4 Edit a program on the background editing screen in the same way as for ordinary program editing.
- 5 After editing is completed, press soft key **[(OPRT)]**, then press soft key **[BG-EDT]**. The edited program is registered in foreground program memory.

Explanation

- **Alarms during background editing**

Alarms that may occur during background editing do not affect foreground operation. Conversely, alarms that may occur during foreground operation do not affect background editing. In background editing, if an attempt is made to edit a program selected for foreground operation, a BP/S alarm (No. 140) is raised. On the other hand, if an attempt is made to select a program subjected to background editing during foreground operation (by means of subprogram calling or program number search operation using an external signal), a P/S alarm (Nos. 059, 078) is raised in foreground operation. As with foreground program editing, P/S alarms occur in background editing. However, to distinguish these alarms from foreground alarms, BP/S is displayed in the data input line on the background editing screen.


9.9 PASSWORD FUNCTION

The password function (bit 4 (NE9) of parameter No. 3202) can be locked using parameter No. 3210 (PASSWD) and parameter No. 3211 (KEYWD) to protect program Nos. 9000 to 9999. In the locked state, parameter NE9 cannot be set to 0. In this state, program Nos. 9000 to 9999 cannot be modified unless the correct keyword is set.


A locked state means that the value set in the parameter PASSWD differs from the value set in the parameter KEYWD. The values set in these parameters are not displayed. The locked state is released when the value already set in the parameter PASSWD is also set in parameter KEYWD. When 0 is displayed in parameter PASSWD, parameter PASSWD is not set.

Procedure for locking and unlocking

Locking

- 1 Set the MDI mode.
- 2 Enable parameter writing. At this time, P/S alarm No. 100 is issued on the CNC.
- 3 Set parameter No. 3210 (PASSWD). At this time, the locked state is set.
- 4 Disable parameter writing.
- 5 Press the  key to release the alarm state.

Unlocking

- 1 Set the MDI mode.
- 2 Enable parameter writing. At this time, P/S alarm No. 100 is issued on the CNC.
- 3 In parameter No. 3211 (KEYWD), set the same value as set in parameter No. 3210 (PASSWD) for locking. At this time, the locked state is released.
- 4 Set bit 4 (NE9) of parameter No. 3202 to 0.
- 5 Disable parameter writing.
- 6 Press the  key to release the alarm state.
- 7 Subprograms from program Nos. 9000 to 9999 can now be edited.

Explanations

- **Setting parameter PASSWD**

The locked state is set when a value is set in the parameter PASSWD. However, note that parameter PASSWD can be set only when the locked state is not set (when PASSWD = 0, or PASSWD = KEYWD). If an attempt is made to set parameter PASSWD in other cases, a warning is given to indicate that writing is disabled. When the locked state is set (when PASSWD = 0 and PASSWD = KEYWD), parameter NE9 is automatically set to 1. If an attempt is made to set NE9 to 0, a warning is given to indicate that writing is disabled.

- **Changing parameter PASSWD**

Parameter PASSWD can be changed when the locked state is released (when PASSWD = 0, or PASSWD = KEYWD). After step 3 in the procedure for unlocking, a new value can be set in the parameter PASSWD. From that time on, this new value must be set in parameter KEYWD to release the locked state.

- **Setting 0 in parameter PASSWD**

When 0 is set in the parameter PASSWD, the number 0 is displayed, and the password function is disabled. In other words, the password function can be disabled by either not setting parameter PASSWD at all, or by setting 0 in parameter PASSWD after step 3 of the procedure for unlocking. To ensure that the locked state is not entered, care must be taken not to set a value other than 0 in parameter PASSWD.

- **Re-locking**

After the locked state has been released, it can be set again by setting a different value in parameter PASSWD, or by turning the power to the NC off then on again to reset parameter KEYWD.

CAUTION


Once the locked state is set, parameter NE9 cannot be set to 0 and parameter PASSWD cannot be changed until the locked state is released or the memory all-clear operation is performed. Special care must be taken in setting parameter PASSWD.

9.10 COPYING A PROGRAM BETWEEN TWO PATHS

For a 2-path control CNC, setting bit 0 (PCP) of parameter No. 3206 to 1 enables the copying of a specified machining program from one path to another. Single-program copy and specified-range copy are supported.

Procedure for copying a program between two paths

Procedure

- 1 Select EDIT mode for both paths.
- 2 Press function key  .
- 3 Press soft key **[(OPRT)]**.
- 4 Press soft key **[P COPY]**.
The following soft keys appear:

```

PROGRAM                                O1357 N00130

O1357 (HEAD-1 MAIN PROGRAM);
N010 G90 G00 X200.0 Z220.0 ;
N020 T0101 ;
N030 S30000 M03 ;
N040 G40 G00 X40.0 Z180.0 ;

N080 X100.0 Z80.0 ;
N090 Z60.0 ;
N100 X140.0 Z40.0 ;

>_

EDIT **** * 14:25:36 HEAD1
{ PATH1 } {   } { PATH2 } {   } { CAN }

```

- 5 Press soft key **[PATH1]** or **[PATH2]** to select the path from which a program is to be copied.
(Example) Pressing soft key **[PATH1]** causes an operation guidance, shown below, to appear on the screen.

```

SOURCE : PATH1 =1357
DEST : PATH2   =      REPLACE : OFF
>_

EDIT **** * 14:25:36 HEAD1
{ SOURCE } { DEST } { REPLACE } { CAN } { EXEC }

```

- First, the program currently selected for the copy source path is displayed as the program to be copied. If no program has been selected for the copy source path, "0000" is displayed.

6 Select one or more programs to be copied.

· Single-program copy

(1) Enter the number of the program to be copied.

→ "× × × ×"

(2) Press soft key **[SOURCE]** to set the number.

→ SOURCE:PATH?="× × × ×"

· Specified-range copy

(1) Enter the range of the programs to be copied, as a number.

→ "× × × ×-□□□□"

[Entry format]	× × × ×	-	□□□□	┌ Range symbol
				└ Range end (largest) number
				└ Range start (smallest) number

(2) Press soft key **[SOURCE]** to set the number.

→ SOURCE:PATH?="× × × ×-□□□□"

· To cancel the selection of the program(s) to be copied, press **[SOURCE]** again.**7** Select the copy destination number.

The selected program(s) can be copied by assigning numbers other than their original numbers.

(1) Type the destination number.

→ "△△△△"

(2) Press soft key **[DEST]** to set the number.

→ DEST:PATH?="△△△△"

· Pressing **[DEST]** without entering any number causes the original program number(s) to be used as is.· To cancel the set number, press **[DEST]** again.

· For specified-range copy, the set number is assigned to the first program of the specified range. The subsequent programs are assigned numbers obtained by repeatedly incrementing the set number by one.

8 Specify replacement.

If any number to be assigned to a program to be copied is already being used for a program registered for the destination path, specify whether the existing program is to be replaced with that to be copied. If replacement is currently disabled, pressing soft key **[REPLACE]** enables replacement. Pressing **[REPLACE]** repeatedly toggles between replacement being enabled and disabled.

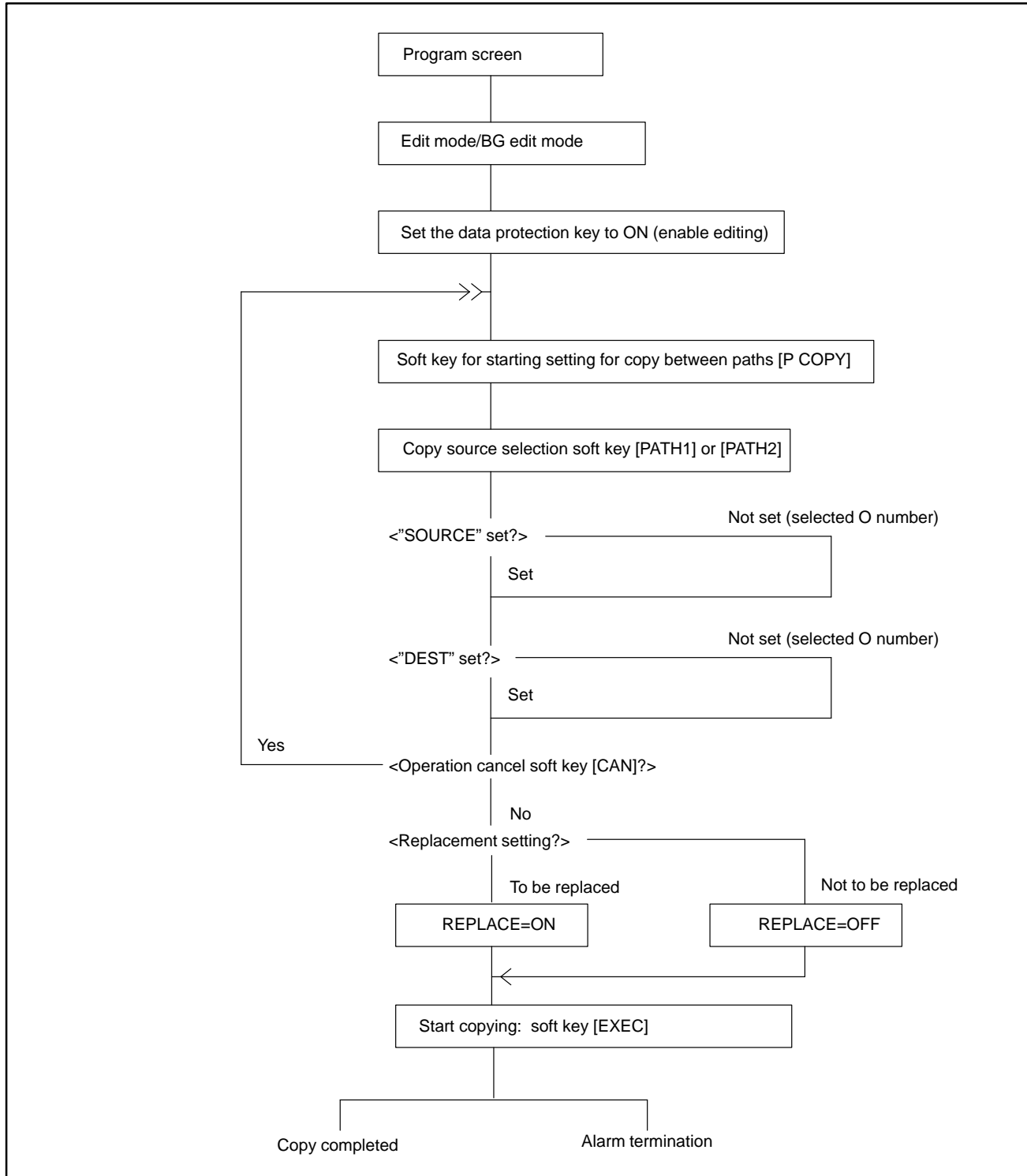
"REPLACE=ON" indicates that replacement is enabled.

"REPLACE=OFF" indicates that replacement is disabled.

9 Press soft key **[EXEC]** to start copying.

Explanations

- Operation flow



- Background editing

Copying can also be performed during background editing.

● **Major related alarms**

Major related alarm numbers

Alarm number	Description	Relevant path
P/S 70,70 BP/S0	Insufficient free memory	Copy destination
P/S 71,71 BP/S	Specified program not found	Copy source
P/S 72,72 BP/S	Too many programs	Copy destination
P/S 73,73 BP/S	Duplicate registration	Copy destination
P/S 75,75 BP/S	Protected program number	Copy source/destination

- BP/S indicates an alarm output during background editing.
- Each alarm is issued to the path for which the operation causing the alarm is being performed.

Restrictions

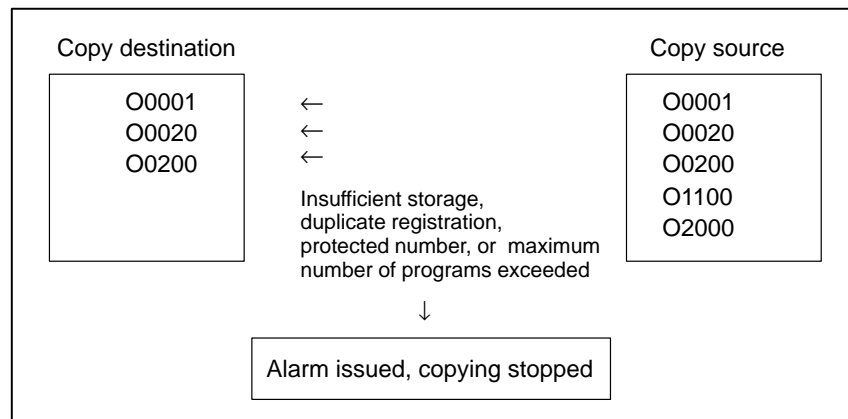
● **Conditions under which copying cannot be performed**

Copying is not performed under any of the following conditions:

- The data protection key for the copy destination path is set to OFF.
- The specified O number is protected.
- The specified O number is already being used for a program registered for the copy destination path (if replacement is disabled).
- The part program storage for the copy destination path does not have sufficient free space.
- The copy source or destination path is placed in the alarm state. During background editing, however, only P/S alarms 000 and 101 disable copying.

● **Specified-range copy**

During specified-range copy, if the part program storage for the copy destination path becomes insufficient, if the maximum number of programs which can be registered for the destination path is exceeded, if a specified program number has already been registered for the destination path, or if a specified program number is protected, an alarm is issued immediately and copying is stopped.



- **Replacement**

Even if replacement is enabled, the program is not replaced if the part program storage for the copy destination path does not have sufficient free space. During background editing, copying by replacing the currently running program is not allowed.

CAUTION

Once the copying of a program between paths has been started, it cannot be canceled. Carefully confirm all the settings before starting copying.

10 CREATING PROGRAMS

Programs can be created using any of the following methods:

- MDI keyboard
- PROGRAMMING IN TEACH IN MODE
- CONVERSATIONAL PROGRAMMING INPUT WITH GRAPHIC FUNCTION
- CONVERSATIONAL AUTOMATIC PROGRAMMING FUNCTION
- AUTOMATIC PROGRAM PREPARATION DEVICE (FANUC SYSTEM P)




This chapter describes creating programs using the MDI panel, Teach IN mode, and conversational programming with graphic function. This chapter also describes the automatic insertion of sequence numbers.

10.1 CREATING PROGRAMS USING THE MDI PANEL

Programs can be created in the EDIT mode using the program editing functions described in III-9.

Procedure for Creating Programs Using the MDI Panel

Procedure




- 1 Enter the **EDIT** mode.
- 2 Press the  key.
- 3 Press address key  and enter the program number.
- 4 Press the  key.
- 5 Create a program using the program editing functions described in III-9.

Explanation


• Comments in a program

Comments can be written in a program using the control in/out codes.

Example) O0001 (FANUC SERIES 16) ;
M08 (COOLANT ON) ;

- When the  key is pressed after the control-out code “(”, comments, and control-in code “)” have been typed, the typed comments are registered.
- When the  key is pressed midway through comments, to enter the rest of comments later, the data typed before the  key is pressed may not be correctly registered (not entered, modified, or lost) because the data is subject to an entry check which is performed in normal editing.

Note the following to enter a comment:






- Control-in code “)” cannot be registered by itself.
- Comments entered after the  key is pressed must not begin with a number, space, or address O.
- If an abbreviation for a macro is entered, the abbreviation is converted into a macro word and registered (see Section 9.7).
- Address O and subsequent numbers, or a space can be entered but are omitted when registered.

10.2 AUTOMATIC INSERTION OF SEQUENCE NUMBERS

Sequence numbers can be automatically inserted in each block when a program is created using the MDI keys in the EDIT mode.
Set the increment for sequence numbers in parameter 3216.

Procedure for automatic insertion of sequence numbers

Procedure

- 1 Set 1 for SEQUENCE NO. (see III-11.4.3).
- 2 Enter the **EDIT** mode.
- 3 Press  to display the program screen.
- 4 Search for or register the number of a program to be edited and move the cursor to the EOB (;) of the block after which automatic insertion of sequence numbers is started.
When a program number is registered and an EOB (;) is entered with the  key, sequence numbers are automatically inserted starting with 0. Change the initial value, if required, according to step 10, then skip to step 7.
- 5 Press address key  and enter the initial value of N.
- 6 Press  .
- 7 Enter each word of a block.
- 8 Press  .

- 9 Press . The EOB is registered in memory and sequence numbers are automatically inserted. For example, if the initial value of N is 10 and the parameter for the increment is set to 2, N12 is inserted and displayed below the line where a new block is specified.

```

PROGRAM                                O0040 N00012
O0040 ;
N10 G92 X0 Y0 Z0 ;
N12
%

>
EDIT ***** 13:18:08
[PRGRM] ([ LIB ]) ([ C.A.P ]) ([ OPRT ])

```

- 10
- In the example above, if N12 is not necessary in the next block, pressing the key after N12 is displayed deletes N12.
 - To insert N100 in the next block instead of N12, enter N100 and press after N12 is displayed. N100 is registered and initial value is changed to 100.

10.3 CREATING PROGRAMS IN TEACH IN MODE (PLAYBACK)








When the playback option is selected, the **TEACH IN JOG** mode and **TEACH IN HANDLE** mode are added. In these modes, a machine position along the X, Y, and Z axes obtained by manual operation is stored in memory as a program position to create a program.

The words other than X, Y, and Z, which include O, N, G, R, F, C, M, S, T, P, Q, and EOB, can be stored in memory in the same way as in **EDIT** mode.

Procedure for Creating Programs in TEACH IN Mode

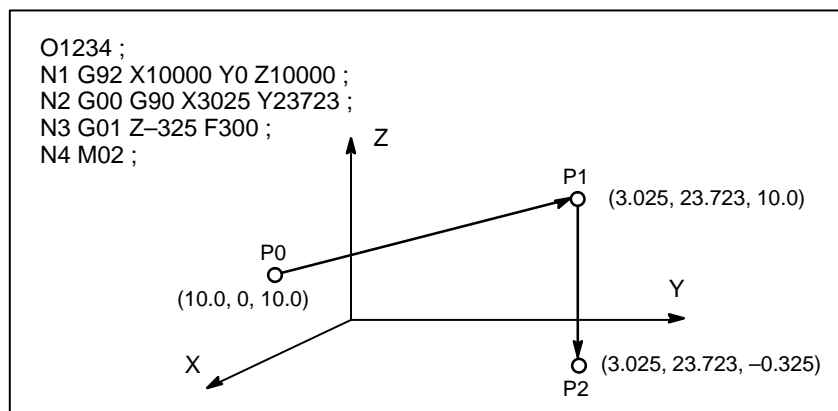
Procedure

The procedure described below can be used to store a machine position along the X, Y, and Z axes.

- 1 Select the **TEACH IN JOG** mode or **TEACH IN HANDLE** mode.
- 2 Move the tool to the desired position with jog or handle.
- 3 Press  key to display the program screen. Search for or register the number of a program to be edited and move the cursor to the position where the machine position along each axis is to be registered (inserted).
- 4 Key in address  .
- 5 Press the  key. Then a machine position along the X axis is stored in memory.
(Example) X10.521 Absolute position (for mm input)
X10521 Data stored in memory
- 6 Similarly, key in  , then press the  key. Then a machine position along the Y axis is stored in memory. Further, key in  , then press the  key. Then a machine position along the Z axis is stored in memory.

All coordinates stored using this method are absolute coordinates.

Examples



- 1 Set the setting data **SEQUENCE NO.** to 1 (on). (The incremental value parameter (No. 3216) is assumed to be “1”.)
- 2 Select the **TEACH IN HANDLE** mode.
- 3 Make positioning at position P0 by the manual pulse generator.
- 4 Select the program screen.

- 5 Enter program number O1234 as follows:

O 1 2 3 4 INSERT

This operation registers program number O1234 in memory.

Next, press the following keys:

EOB INSERT

An EOB (;) is entered after program number O1234. Because no number is specified after N, sequence numbers are automatically inserted for N0 and the first block (N1) is registered in memory.

- 6 Enter the P0 machine position for data of the first block as follows:

G 9 2 INSERT X INSERT Y INSERT Z
INSERT EOB INSERT

This operation registers G92X10000Y0Z10000; in memory. The automatic sequence number insertion function registers N2 of the second block in memory.

- 7 Position the tool at P1 with the manual pulse generator.

- 8 Enter the P1 machine position for data of the second block as follows:

G 0 0 INSERT G 9 0 X INSERT Y
INSERT EOB INSERT

This operation registers G00G90X3025Z23723; in memory. The automatic sequence number insertion function registers N3 of the third block in memory.

- 9 Position the tool at P2 with the manual pulse generator.

- 10 Enter the P2 machine position for data of the third block as follows:


G 0 1 INSERT Z INSERT F 3 0 0
INSERT EOB INSERT

This operation registers G01Z-325F300; in memory.

The automatic sequence number insertion function registers N4 of the fourth block in memory.

- 11 Register M02; in memory as follows:

M 0 2 INSERT EOB INSERT

N5 indicating the fifth block is stored in memory using the automatic sequence number insertion function. Press the  key to delete it.

This completes the registration of the sample program.

Explanations

- **Checking contents of the memory**

The contents of memory can be checked in the **TEACH IN** mode by using the same procedure as in **EDIT** mode.

```

PROGRAM                                O1234 N00004
(RELATIVE)                             (ABSOLUTE)
X   -6.975                             X    3.025
Y   23.723                             Y   23.723
Z  -10.325                             Z   -0.325

O1234 ;
N1 G92 X10000 Y0 Z10000 ;
N2 G00 G90 X3025 Y23723 ;
N3 G01 Z-325 F300 ;
N4 M02 ■
%

>_
THND  ****  ***  ***                                14 : 17 : 27
(PRGRM) ( LIB ) ( ) ( ) ( ) ( (OPRT) )

```

- **Registering a position with compensation**

When a value is keyed in after keying in address **X**, **Y**, or **Z**, then the **INSERT** key is pressed, the value keyed in for a machine position is added for registration. This operation is useful to correct a machine position by key-in operation.

- **Registering commands other than position commands**

Commands to be entered before and after a machine position must be entered before and after the machine position is registered, by using the same operation as program editing in **EDIT** mode.


10.4 CONVERSATIONAL PROGRAMMING WITH GRAPHIC FUNCTION

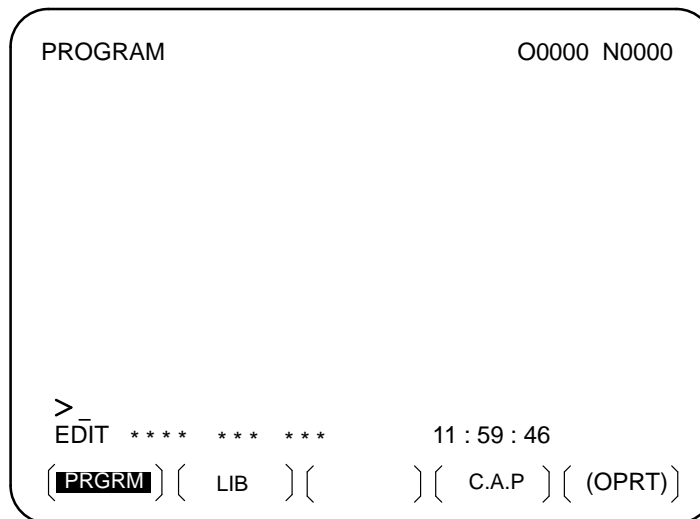
Programs can be created block after block on the conversational screen while displaying the G code menu.






Blocks in a program can be modified, inserted, or deleted using the G code menu and conversational screen.


Procedure for Conversational Programming with Graphic Function

Procedure 1 Creating a program

- 1 Enter the **EDIT** mode.
- 2 Press . If no program is registered, the following screen is displayed. If a program is registered, the program currently selected is displayed.



- 3 Key in the program number of a program to be registered after keying in address O, then press . For example, when a program with program number 10 is to be registered, key in   , then press . This registers a new program O0010.


- 4 Press the [**C.A.P**] soft key. The following G code menu is displayed on the screen.
If soft keys different from those shown in step 2 are displayed, press the menu return key  to display the correct soft keys.

```

PROGRAM                                O1234 N00004
G00 : POSITIONING
G01 : LINEAR IPL
G02 : CIRCULAR IPL. CW
G03 : CIRCULAR IPL. CCW
G04 : DWELL
G09 : EXACT STOP CHECK
G10 : OFFSET&TLC VALUE SETTING (0)
G17 : XY PLANE
G18 : ZX PLANE
G19 : YZ PLANE
G20 : INCH
G21 : METRIC
>
EDIT ***** ** 14:26:15

{ PRGRM } { } { G.MENU } { BLOCK } { }

```

- 5 Key in the G code corresponding to a function to be programmed. When the positioning function is desired, for example, the G code menu lists the function with the G code G00. So key in G00. If the screen does not indicate a function to be programmed, press the page key  to display the next G code menu screen. Repeat this operation until a desired function appears. If a desired function is not a G code, key in no data.
- 6 Press the soft key [**BLOCK**] to display a detailed screen for a keyed in G code. The figure below shows an example of detailed screen for G00.

```

PROGRAM                                O1234 N00000
G00 : POSITIONING

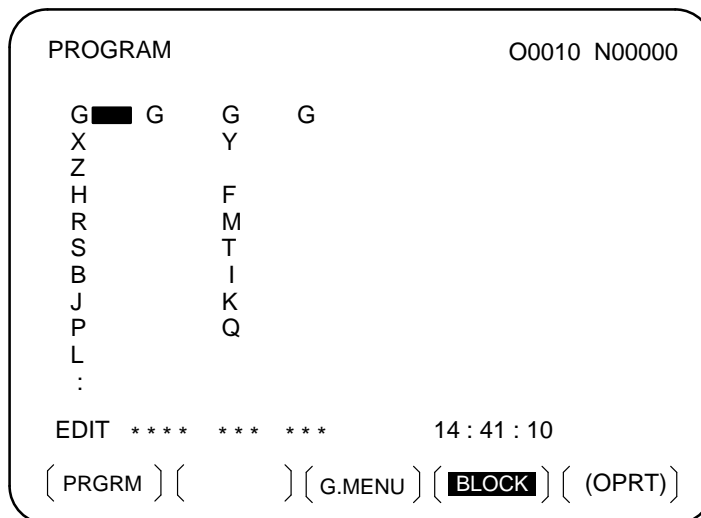
G00 G   G   G
X  100. Y   50.0
Z
H           OFFSET NO.
M
S
T
B
:

EDIT ***** ** 14:32:57

{ PRGRM } { } { G.MENU } { BLOCK } { (OPRT) }

```

When no keys are pressed, the standard details screen is displayed.




- 7 Move the cursor to the block to be modified on the program screen. At this time, a data address with the cursor blinks.
- 8 Enter numeric data by pressing the numeric keys and press the **[INPUT]** soft key or key. This completes the input of one data item.
- 9 Repeat this operation until all data required for the entered G code is entered.
- 10 Press the key. This completes the registration of data of one block in program memory. On the screen, the G code menu screen is displayed, allowing the user to enter data for another block. Repeat the procedure starting with 5 as required.
- 11 After registering all programs, press the **[PRGRM]** soft key. The registered programs are converted to the conversational format and displayed.
- 12 Press the key to return to the program head.

Procedure 2 Modifying a block


- 1 Move the cursor to the block to be modified on the program screen and press the **[C.A.P]** soft key. Or, press the **[C.A.P]** soft key first to display the conversational screen, then press the or page key until the block to be modified is displayed.
- 2 When data other than a G code is to be altered, just move the cursor to the data and key in a desired value, then press the **[INPUT]** soft key or key.
- 3 When a G code is to be altered, press the menu return key and the soft key **[G.MENU]**. Then the G code menu appears. Select a desired G code, then key in the value. For example, to specify a cutting feed, since the G code menu indicates G01, key in G01. Then press the soft key **[BLOCK]**. The detailed screen of the G code is displayed, so enter the data.

Procedure 3 Inserting a block


4 After data is changed completely, press the  key. This operation replaces an entire block of a program.

1 On the conversational screen, display the block immediately before a new block is to be inserted, by using the page keys. On the program screen, move the cursor with the page keys and cursor keys to immediately before the point where a new block is to be inserted.

2 Press the soft key **[G.MENU]** to display the G code menu. Then enter new block data.

3 When input of one block of data is completed in step 2, press the  key. This operation inserts a block of data.

Procedure 4 Deleting a block

1 On the conversational screen, display the contents of a block to be deleted, then press the  key.

2 The contents of the block displayed are deleted from program memory. Then the contents of the next block are displayed on the conversational screen.

11

SETTING AND DISPLAYING DATA

General


To operate a CNC machine tool, various data must be set on the MDI panel for the CNC. The operator can monitor the state of operation with data displayed during operation.

This chapter describes how to display and set data for each function.






Explanations

Screen transition chart



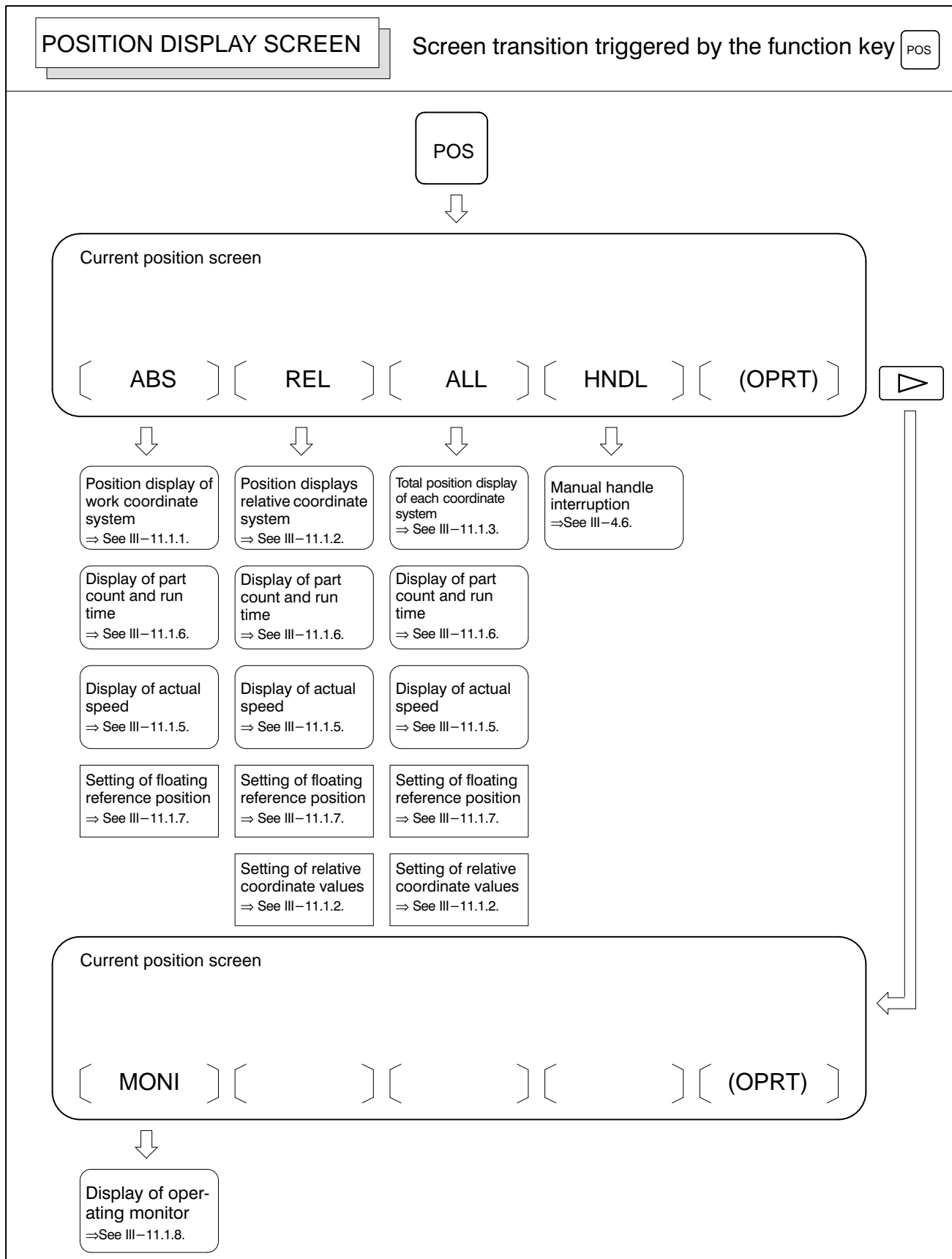
MDI function keys
(Shaded keys () are described in this chapter.)

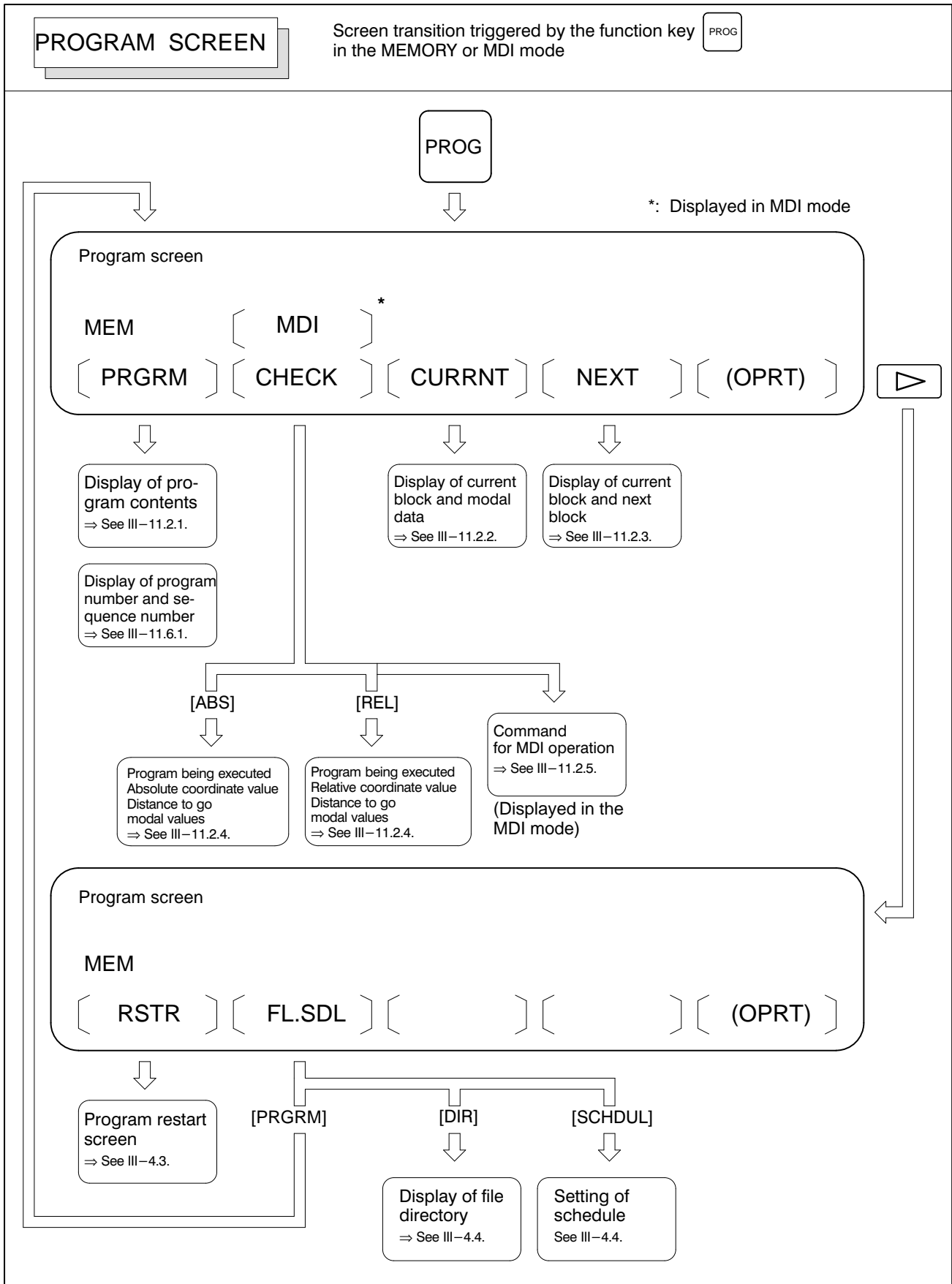
The screen transition for when each function key on the MDI panel is pressed is shown below. The subsections referenced for each screen are also shown. See the appropriate subsection for details of each screen and the setting procedure on the screen. See other chapters for screens not described in this chapter.

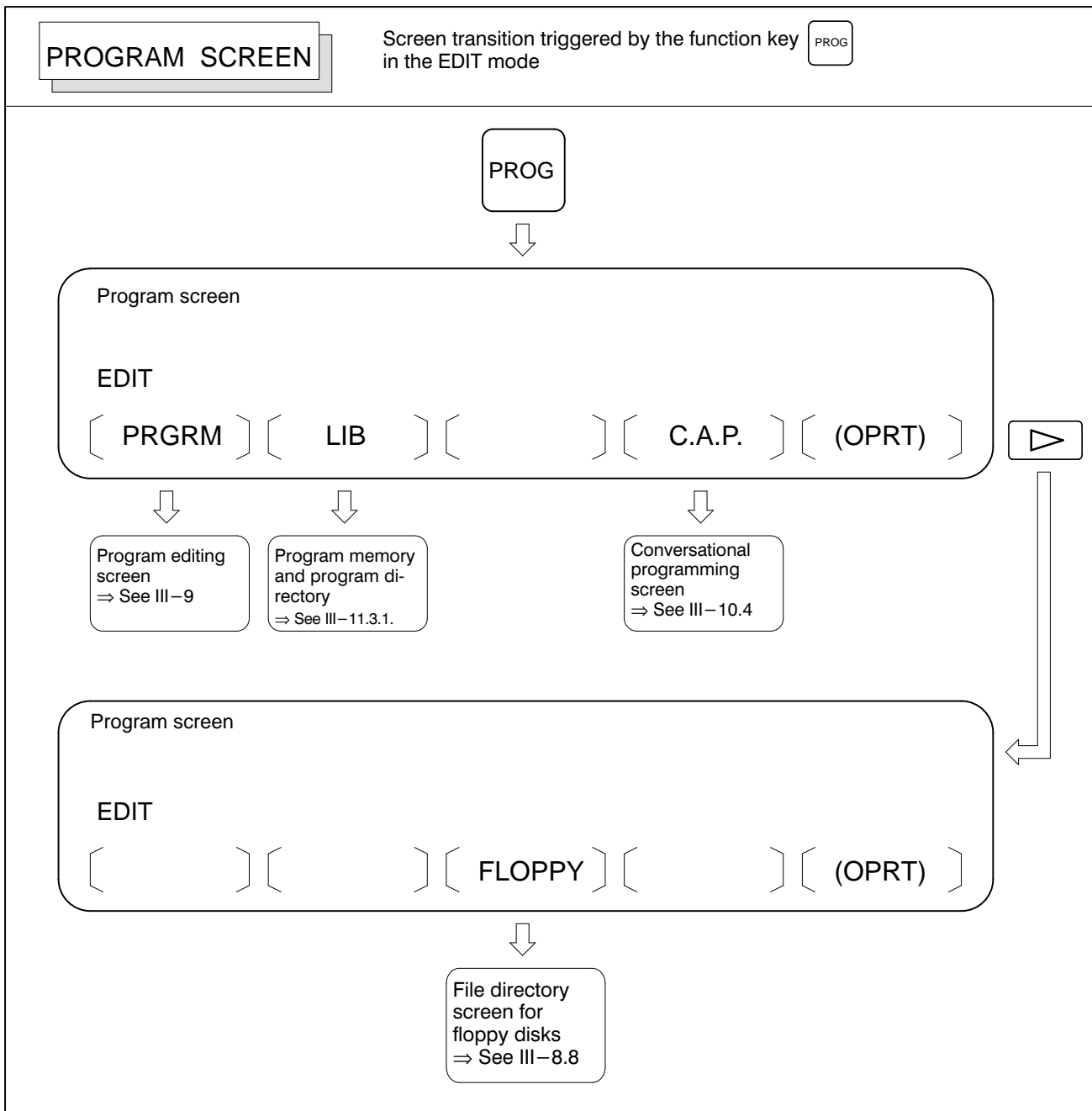
See Chapter 7 for the screen that appears when function key  is pressed. See Chapter 12 for the screen that appears when function key  is pressed. See Chapter 13 for the screen that appears when function key  is pressed. In general, function key  is prepared by the machine tool builder and used for macros. Refer to the manual issued by the machine tool builder for the screen that appears when function key  is pressed.

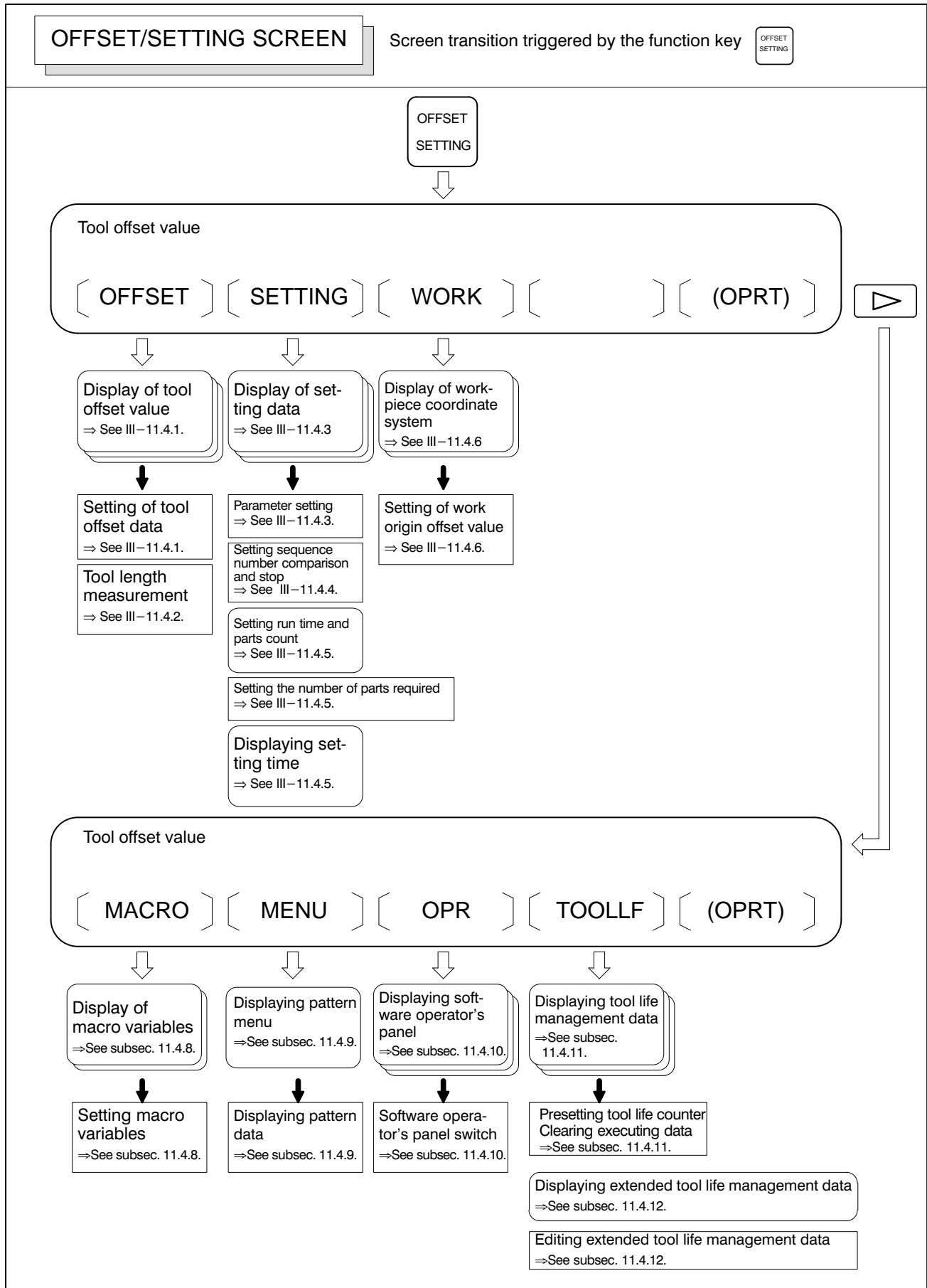
• Data protection key

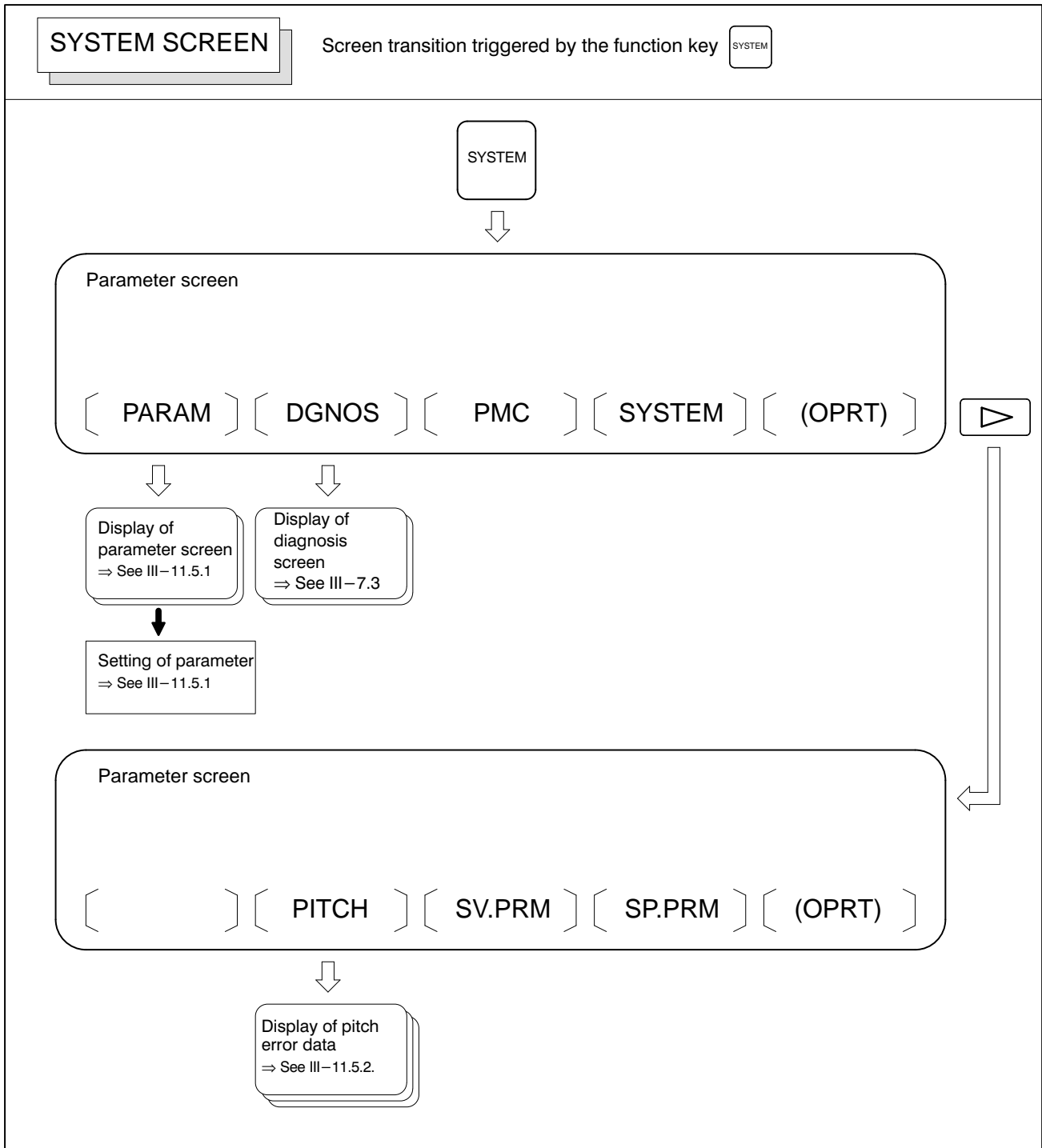
The machine may have a data protection key to protect part programs, tool compensation values, setting data, and custom macro variables. Refer to the manual issued by the machine tool builder for where the data protection key is located and how to use it.











- **Setting screens**

The table below lists the data set on each screen.

Table.11. Setting screens and data on them

No.	Setting screen	Contents of setting	Reference item
1	Tool offset value	Tool offset value Tool length offset value Cutter compensation value	III-11.4.1
		Tool length measurement	III-11.4.2
2	Setting data(handy)	Parameter write TV check Punch code Input unit (mm/inch) I/O channel Automatic insert of Sequence No. Conversion of tape format (F15)	III-11.4.3
		Sequence number comparison and stop	III-11.4.4
3	Setting data (mirror image)	Mirror image	III-11.4.3
4	Setting data (timer)	Parts required	III-11.4.5
5	Macro variables	Custom macro common variables (#100 to #149) or (#100 to #199) (#500 to #531) or (#500 to #599)	III-11.4.8
6	Parameter	Parameter	III-11.5.1
7	Pitch error	Pitch error compensation data	III-11.5.2
8	software operator's panel	Mode selection Jog feed axis selection Jog rapid traverse Axis selection for Manual pulse generator Multiplication for manual pulse generator Jog feedrate Feedrate override Rapid traverse override Optional block skip Single block Machine lock Dry run Protect key Feed hold	III-11.4.10
9	Tool life data (Tool life management)	Life count	III-11.4.11
10	Tool life data (Extended tool life management)	Life count type (cycle or minute) Life value Life counter Tool number H code D code New tool group New tool number Skipping tool Clearing tool	III-11.4.12
11	Work coordinate system setting	Work origin offset value	III-11.4.6
12	Current position display screen	Floating reference position	III-11.1.7

11.1


SCREENS DISPLAYED BY FUNCTION KEY


Press function key  to display the current position of the tool.

The following three screens are used to display the current position of the tool:

- Position display screen for the work coordinate system.
- Position display screen for the relative coordinate system.
- Overall position display screen.

The above screens can also display the feedrate, run time, and the number of parts. In addition, a floating reference position can be set on these screens.


Function key  can also be used to display the load on the servo motor and spindle motor and the rotation speed of the spindle motor (operating monitor display).

Function key  can also be used to display the screen for displaying the distance moved by handle interruption. See III-4.8 for details on this screen.

11.1.1 Position Display in the Work Coordinate System

Displays the current position of the tool in the workpiece coordinate system. The current position changes as the tool moves. The least input increment is used as the unit for numeric values. The title at the top of the screen indicates that absolute coordinates are used.

Display procedure for the current position screen in the workpiece coordinate system

- 1 Press function key  .
- 2 Press soft key **[ABS]**.
- 3 On a 9" CRT, press the **[ABS]** soft key one more time to display the coordinates along axes other than the six standard axes.

- Display with one-path control

ACTUAL POSITION(ABSOLUTE) O1000 N00010

X	123.456
Y	363.233
Z	0.000

RUN TIME 0H15M	PART COUNT 5
ACT.F 3000 MM/M	CYCLE TIME 0H 0M38S
	S 0 T0000
MEM STRT MTN ***	09:06:35
[ABS] [REL] [ALL] [HNDL] [OPRT]	

- Display with two-path control
(7.2"/8.4"LCD)

ACTUAL POSITION(ABSOLUTE) O1000 N00010

X ₁	100.000
Z ₁	200.000
X ₁	300.000

RUN TIME 0H15M	PART COUNT 5
ACT.F 3000 MM/M	CYCLE TIME 0H 0M38S
	S 0 T0000
MEM STRT MTN ***	09:06:35 HEAD1
[ABS] [REL] [ALL] [HNDL] [(OPRT)]	

- **Display with two-path control (9.5"/10.4"LCD)**

ACTUAL POSITION O1000 N10010		O2000 N20010	
(ACTUAL)		(ACTUAL)	
X ₁	100.000	X ₂	400.000
Y ₁	200.000	Y ₂	500.000
Z ₁	300.000	Z ₂	600.000
(ACTUAL SPEED) F : 0MM/MIN		(ACTUAL SPEED) F : 0MM/MIN	
S : 0RPM		S : 0RPM	
(PARTS COUNT) 114		(PARTS COUNT) 114	
(RUN TIME) 5H 3M		(RUN TIME) 5H 3M	
(CYCLE TIME) 0H 0M 6S		(CYCLE TIME) 0H 0M 6S	
		MEM STOP *** ** 12:34:56 HEAD1	
		[ABS] REL ALL	

Explanations

- **Display including compensation values**
- **Displaying the sixth and subsequent axes**


Bits 6 and 7 of parameter 3104 (DAL, DAC) can be used to select whether the displayed values include tool length offset and cutter compensation.

Only the coordinates for the first to fifth axes are displayed initially whenever when there are six or more controlled axes. Pressing the **[ABS]** soft key displays the coordinates for the sixth and subsequent axes.

11.1.2 Position Display in the Relative Coordinate System

Displays the current position of the tool in a relative coordinate system based on the coordinates set by the operator. The current position changes as the tool moves. The increment system is used as the unit for numeric values. The title at the top of the screen indicates that relative coordinates are used.

Display procedure for the current position screen with the relative coordinate system

- 1 Press function key  .
- 2 Press soft key [REL].
- 3 On a 9" CRT, press the [REL] soft key one more time to display the coordinates along axes other than the six standard axes.

• Display with one-path control

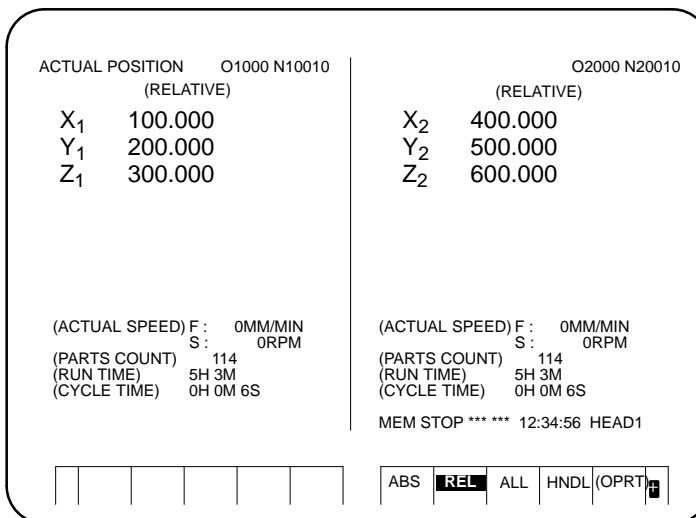
ACTUAL POSITION(RELATIVE)		O1000 N00010
X	123.456	
Y	363.233	
Z	0.000	
PART COUNT		5
RUN TIME	0H15M	CYCLE TIME
ACT.F	3000 MM/M	0H 0M38S
		S 0 T0000
MEM STRT MTN ***		09:06:35
[ABS] [REL] [ALL] [HNDL] [OPRT]		

See Explanations for the procedure for setting the coordinates.

• Display with two-path control (7.2"/8.4"LCD)

ACTUAL POSITION(RELATIVE)		O1000 N00010
X ₁	100.000	
Y ₁	200.000	
Z ₁	300.000	
PART COUNT		5
RUN TIME	0H15M	CYCLE TIME
ACT.F	3000 MM/M	0H 0M38S
		S 0 T0000
MEM STRT MTN ***		09:06:35 HEAD1
[ABS] [REL] [ALL] [HNDL] [(OPRT)]		

● **Display with two-path control)
(9.5"/10.4"LCD)**



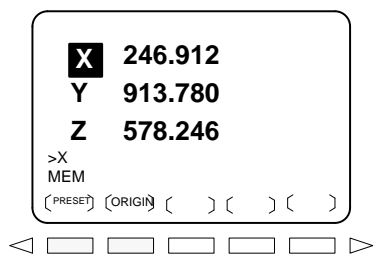
Explanations

● **Setting the relative coordinates**

The current position of the tool in the relative coordinate system can be reset to 0 or preset to a specified value as follows:

Procedure to set the axis coordinate to a specified value

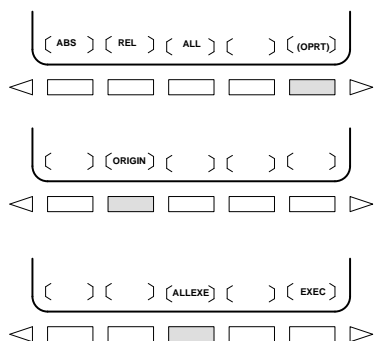
Procedure



- 1 Enter an axis address (such as X or Y) on the screen for the relative coordinates. The indication for the specified axis blinks and the soft keys change as shown on the left.
- 2 · To reset the coordinate to 0, press soft key **[ORIGIN]**. The relative coordinate for the blinking axis is reset to 0.
· To preset the coordinate to a specified value, enter the value and press soft key **[PRESET]**. The relative coordinate for the blinking axis is set to the entered value.

Procedure to reset all axes

Procedure



- 1 Press soft key **[(OPRT)]**.
- 2 Press soft key **[ORIGIN]**.
- 3 Press soft key **[ALLEXE]**.
The relative coordinates for all axes are reset to 0.


- **Display including compensation values**
Bits 6 and 7 of parameter 3104 (DRL, DRC) can be used to select whether the displayed values include tool length offset and cutter compensation.
- **Presetting by setting a coordinate system**
Bit 3 of parameter 3104 (PPD) is used to specify whether the displayed positions in the relative coordinate system are preset to the same values as in the workpiece coordinate system when a coordinate system is set by a G92 command or when the manual reference position return is made.
- **Displaying the sixth and subsequent axes**
Only the coordinates for the first to fifth axes are displayed initially whenever there are six or more controlled axes. Pressing the **[ABS]** soft key displays the coordinates for the sixth and subsequent axes.

11.1.3 Overall Position Display

Displays the following positions on a screen : Current positions of the tool in the workpiece coordinate system, relative coordinate system, and machine coordinate system, and the remaining distance. The relative coordinates can also be set on this screen. See III-11.1.2 for the procedure.

Procedure for displaying overall position display screen

Procedure

- 1 Press function key  .
- 2 Press soft key **[ALL]**.

• Display with one-path control

```

ACTUAL POSITION                O1000 N00010
(RELATIVE)                   (ABSOLUTE)
X 246.912                    X 123.456
Y 913.780                    Y 456.890
Z 1578.246                   Z 789.123

(MACHINE)                    (DISTANCE TO GO)
X 0.000                      X 0.000
Y 0.000                      Y 0.000
Z 0.000                      Z 0.000

RUN TIME 0H15M              PART COUNT      5
ACT.F 3000 MM/M            CYCLE TIME 0H 0M38S
MEM **** * * * *          09:06:35
[ ABS ] [ REL ] [ ALL ] [ HNDL ] [ OPRT ]

```

• Display with two-path control (7.2"/8.4"LCD)

```

ACTUAL POSITION                O1000 N00010
(RELATIVE)                   (ABSOLUTE)
X1 100.000                   X1 100.000
Y1 200.000                   Y1 200.000
Z1 300.000                   Z1 300.000

(MACHINE)                    (DISTANCE TO GO)
X1 100.000                   X1 000.000
Y1 200.000                   Y1 000.000
Z1 300.000                   Z1 000.000
                               Z2 000.000

PART COUNT      5
RUN TIME 0H15M  CYCLE TIME 0H 0M38S
ACT.F 3000 MM/M S 0 T0000
MEM **** * * * *          09:06:35  HEAD1
[ ABS ] [ REL ] [ ALL ] [ HNDL ] [(OPRT)]

```


- **Display with two-path control (9.5"/10.4"LCD)**

ACTUAL POSITION O1000 N10010		O2000 N20010	
(RELATIVE)	(ABSOLUTE)	(RELATIVE)	(ABSOLUTE)
X1 100.000	X1 100.000	X1 100.000	X1 100.000
Y1 100.000	Y1 100.000	Y1 200.000	Y1 200.000
Z1 300.000	Z1 300.000	Z1 300.000	Z1 300.000
(MACHINE)	(DISTANCE TO GO)	(MACHINE)	(DISTANCE TO GO)
X1 100.000	X1 000.000	X1 100.000	X1 000.000
Y1 200.000	Y1 000.000	Y1 200.000	Y1 000.000
Z1 300.000	Z1 000.000	Z1 300.000	Z1 000.000
(ACTUAL SPEED) F: 0MM/MIN	S: 0RPM	(ACTUAL SPEED) F: 0MM/MIN	S: 0RPM
(PARTS COUNT) 114		(PARTS COUNT) 114	
(RUN TIME) 5H 3M		(RUN TIME) 5H 3M	
(CYCLE TIME) 0H 0M 6S		(CYCLE TIME) 0H 0M 6S	
MEM STOP **** ** 12:34:56 HEAD1			

Explanations

- **Coordinate display**

The current positions of the tool in the following coordinate systems are displayed at the same time:

- Current position in the relative coordinate system (relative coordinate)
- Current position in the work coordinate system (absolute coordinate)
- Current position in the machine coordinate system (machine coordinate)
- Distance to go (distance to go)

- **Distance to go**

The distance remaining is displayed in the MEMORY or MDI mode. The distance the tool is yet to be moved in the current block is displayed.

- **Machine coordinate system**

The least command increment is used as the unit for values displayed in the machine coordinate system. However, the least input increment can be used by setting bit 0 (MCN) of parameter 3104.

- **Displaying the sixth and subsequent axes**

Only the coordinates for the first to fifth axes are displayed initially whenever there are six or more controlled axes. Pressing the **[ALL]** soft key displays the coordinates for the sixth and subsequent axes.

- **Displaying the fifth and subsequent axes**

Relative coordinates cannot be displayed together with absolute coordinates whenever there are five or more controlled axes. Pressing the **[ALL]** soft key toggles the display between absolute and relative coordinates.

- **Resetting the relative coordinates**

The total position display screen also supports the resetting of the relative coordinates to 0 or presetting of them to specified values. See the procedure for resetting the relative coordinates described in Subsection III-11.1.2

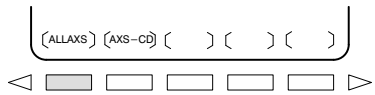
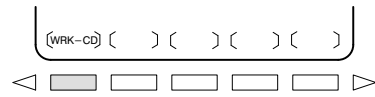
11.1.4 Presetting the Workpiece Coordinate System

A workpiece coordinate system shifted by an operation such as manual intervention can be preset using MDI operations to a pre-shift workpiece coordinate system. The latter coordinate system is displaced from the machine zero point by a workpiece zero point offset value.

A command (G92.1) can be programmed to preset a workpiece coordinate system. (See II-7.2.4 in the section for programming.)

Procedure for Presetting the Workpiece Coordinate System

Procedure



- 1 Press function key POS .
- 2 Press soft key **[(OPRT)]**.
- 3 When **[WRK-CD]** is not displayed, press the continuous menu key ▶ .
- 4 Press soft key **[WRK-CD]**.
- 5 Press soft key **[ALLAXS]** to preset all axes.
- 6 To preset a particular axis in step 5, enter the axis name (X , Y , ...) and 0 , then press soft key **[AXS-CD]**.

Explanations

- **Operation mode**
- **Presetting relative coordinates**

This function can be executed when the reset state or automatic operation stop state is entered, regardless of the operation mode.

As with absolute coordinates, bit 3 (PPD) of parameter No. 3104 is used to specify whether to preset relative coordinates (RELATIVE).

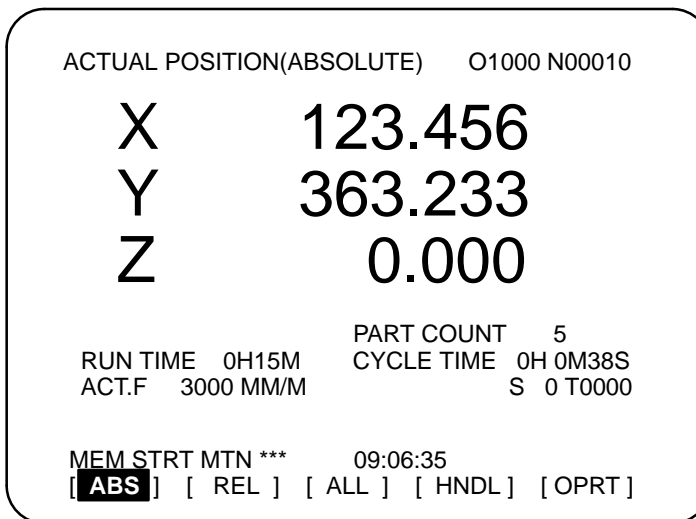
11.1.5 Actual Feedrate Display

The actual feedrate on the machine (per minute) can be displayed on a current position display screen or program check screen by setting bit 0 (DPF) of parameter 3105. On the 9.5"/10.4" LCD, the actual feedrate is always displayed.

Display procedure for the actual feedrate on the current position display screen

Procedure

- 1 Press function key POS to display a current position display screen.



Actual feedrate is displayed after ACT.F.

Explanations

The actual feedrate is displayed in units of millimeter/min or inch/min (depending on the specified least input increment) under the display of the current position.

- **Actual feedrate value**

The actual rate is calculated by the following expression:

$$Fact = \sqrt{\sum_{i=1}^n (f_i)^2}$$

where

n : Number of axes

f_i : Cutting feed rate in the tangential direction of each axis or rapid traverse rate

Fact : Actual feedrate displayed

The display unit: mm/min (metric input).

inch/min (Inch input, Two digits below the decimal point are displayed.)

The feedrate along the PMC axis can be omitted by setting bit 1 (PCF) of parameter 3105.

- **Actual feedrate display of feed per revolution**

In the case of feed per revolution and thread cutting, the actual feedrate displayed is the feed per minute rather than feed per revolution.

- **Actual feedrate display of rotary axis**
In the case of movement of rotary axis, the speed is displayed in units of deg/min but is displayed on the screen in units of input system at that time. For example, when the rotary axis moves at 50 deg/min, the following is displayed: 0.50 INCH/M
- **Actual feedrate display on the other screen**
The program check screen also displays the actual feedrate.

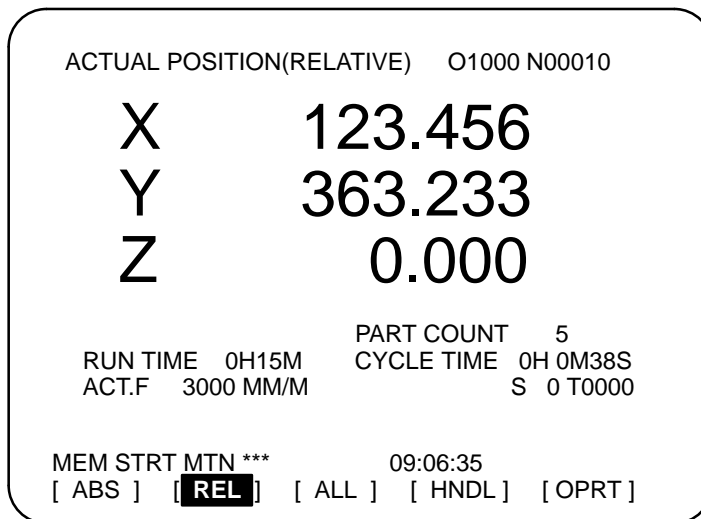
11.1.6 Display of Run Time and Parts Count

The run time, cycle time, and the number of machined parts are displayed on the current position display screens.

Procedure for displaying run time and parts count on the current position display screen

Procedure

- 1 Press function key POS to display a current position display screen.



The number of machined parts (PART COUNT), run time (RUN TIME), and cycle time (CYCLE TIME) are displayed under the current position.

Explanations

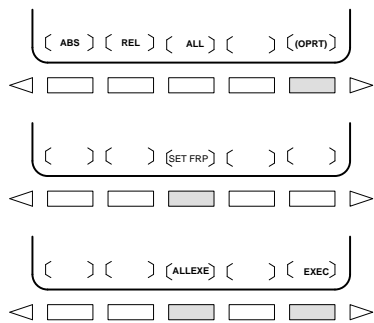
- **PART COUNT** Indicates the number of machined parts. The number is incremented each time M02, M30, or an M code specified by parameter 6710 is executed.
- **RUN TIME** Indicates the total run time during automatic operation, excluding the stop and feed hold time.
- **CYCLE TIME** Indicates the run time of one automatic operation, excluding the stop and feed hold time. This is automatically preset to 0 when a cycle start is performed at reset state. It is preset to 0 even when power is removed.
- **Display on the other screen** Details of the run time and the number of machined parts are displayed on the setting screen. See III-11.4.5.
- **Parameter setting** The number of machined parts and run time cannot be set on current position display screens. They can be set by parameters No. 6711, 6751, and 6752 or on the setting screen.
- **Incrementing the number of machined parts** Bit 0 (PCM) of parameter 6700 is used to specify whether the number of machined parts is incremented each time M02, M30, or an M code specified by parameter 6710 is executed, or only each time an M code specified by parameter 6710 is executed.

11.1.7 Setting the Floating Reference Position

To perform floating reference position return with a G30.1 command, the floating reference position must be set beforehand.

Procedure for setting the floating reference position

Procedure



- 1 Press function key **POS** to display a screen used for displaying the current position.
 - 2 Move the tool to the floating reference position by jogging.
 - 3 Press soft key **[(OPRT)]**.
 - 4 Press soft key **[SET FRP]**.
 - 5 To register the floating reference positions for all axes, press soft key **[ALLEXE]**.
To register the floating reference position of a specific axis, enter the name of the axis [**X** , **Y** , etc.), then press soft key **[EXEC]**. Two or more names can be entered consecutively (e.g., **X** **Y** **Z** **[EXEC]**).
- The above operation stores the floating reference position. It can be checked with parameter (no. 1244).
- 6 In step 4, the floating reference position along a specified axis can also be stored by entering the axis name (such as **X** or **Y**) and pressing soft key **[SET FRP]**.

Explanations

- **Presetting the relative coordinate system**



By parameter FPC (bit 3 of parameter 1201), the relative position can be preset to 0 when a floating reference position is registered.

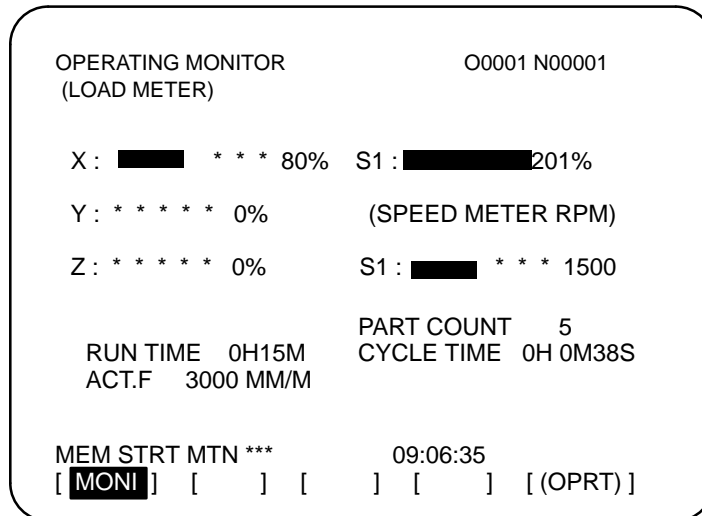
11.1.8 Operating Monitor Display

The reading on the load meter can be displayed for each servo axis and the serial spindle by setting bit 5 (OPM) of parameter 3111 to 1. The reading on the speedometer can also be displayed for the serial spindle.

Procedure for displaying the operating monitor

Procedure

- 1 Press function key  to display a current position display screen.
- 2 Press the continuous-menu key .
- 3 Press soft key **[MONI]**.



Explanations

- **Display of the servo axes** The reading on the load meter can be displayed for up to eight servo axes by setting parameters 3151 to 3158. When all these parameters are set to 0, data is displayed only to the 3rd axis.
- **Display of the spindle axes** When serial spindles are used, the reading on the load meter and speedometer can be displayed only for the main serial spindle.
- **Unit of graph** The bar graph for the load meter shows load up to 200% (only a value is displayed for load exceeding 200%). The bar graph for the speedometer shows the ratio of the current spindle speed to the maximum spindle speed (100%).
- **Load meter** The reading on the load meter depends on servo parameter 2086 and spindle parameter 4127.

- **Speedometer**

Although the speedometer normally indicates the speed of the spindle motor, it can also be used to indicate the speed of the spindle by setting bit 6 (OPS) of parameter 3111 to 1.

The spindle speed to be displayed during operation monitoring is calculated from the speed of the spindle motor (see the formula below). The spindle speed can therefore be displayed, during operation monitoring, even when no position coder is used. To display the correct spindle speed, however, the maximum spindle speed for each gear (spindle speed at each gear ratio when the spindle motor rotates at the maximum speed) must be set in parameters No. 3741 to 3744.

The input of the clutch and gear signals for the first serial spindle is used to determine the gear which is currently selected. Control the input of the CTH1A and CTH2A signals according to the gear selection, by referring to the table below.

(Formula for calculating the spindle speed to be displayed)

$$\text{Spindle speed displayed during operation monitoring} = \frac{\text{Speed of spindle motor}}{\text{Maximum speed of spindle motor}} \times \text{Maximum spindle speed with the gear being used}$$

The following table lists the correspondence between clutch and gear selection signals CTH1A and CTH2A, used to determine the gear being used, and parameters:


CTH1A	CTH2A	Parameter	Serial spindle spec
0	0	=No.3741 (Maximum spindle speed with gear 1)	HIGH
0	1	=No.3742 (Maximum spindle speed with gear 2)	MEDIUM HIGH
1	0	=No.3743 (Maximum spindle speed with gear 3)	MEDIUM LOW
1	1	=No.3744 (Maximum spindle speed with gear 4)	LOW

The speed of the spindle motor and spindle can be displayed, during operation monitoring, only for the first serial spindle and the spindle switching axis for the first serial spindle. It cannot be displayed for the second spindle.


- **Color of graph**

If the value of a load meter exceeds 100%, the bar graph turns purple.

11.2 SCREENS DISPLAYED BY FUNCTION KEY (IN MEMORY MODE OR MDI MODE)

This section describes the screens displayed by pressing function key  in MEMORY or MDI mode. The first four of the following screens display the execution state for the program currently being executed in MEMORY or MDI mode and the last screen displays the command values for MDI operation in the MDI mode:

1. Program contents display screen
2. Current block display screen
3. Next block display screen
4. Program check screen
5. Program screen for MDI operation
6. Stamping the machining time


Function key  can also be pressed in MEMORY mode to display the program restart screen and scheduling screen.
See III-4.5 for the program restart screen.
See III-4.6 for the scheduling screen.

11.2.2 Current Block Display Screen

Displays the block currently being executed and modal data in the MEMORY or MDI mode.

Procedure for displaying the current block display screen

Procedure

- 1 Press function key  .
- 2 Press chapter selection soft key **[CURRNT]**.
The block currently being executed and modal data are displayed.
The screen displays up to 22 modal G codes and up to 11 G codes specified in the current block.

```

PROGRAM                                O2000 N00130
(CURRNT)                                (MODAL)
G01 X 17.500   G67   G01 F 2000
G17 F 2000     G54   G17
G41 H 2        G64   G91
G80           G69   G22
              G15   G94
              G40 .1 G21 H 2 D
              G25   G41
                   G49 T
                   G80
                   G98 S
                   G50
>_ S 0 T0000
MEM STRT ***          16:05:59
[ PRGRM ] [ CHECK ] [ CURRNT ] [ NEXT ] [ (OPRT) ]

```

Explanations







- 9.5"/10.4"LCD

The current block display screen is not provided for 9.5"/10.4" LCD. Press soft key **[PRGRM]** to display the contents of the program on the right half of the screen. The block currently being executed is indicated by the cursor. Modal data is displayed on the left half of the screen. The screen displays up to 18 modal G codes.

```

ACTUAL POSITION                            O3001 N00000
(ABSOLUTE)                                F          0 MM/MIN
X          0.000
Y          0.000
Z          30.000
(MODAL)
G00 G40 G54 F 500 M 3
G17 G43 G64
G90 G80 G69 H 5
G22 G90 G15 D          T 9
G94 G50 G25
G21 G67 S 6000
          SACT 0
PROGRAM
O3001 ;
G40 ;
G49 M06 T9 ;
G0 G54 G90 X0 Y0 ;
G43 Z30. H5 S6000 M3 ;
M0 ;
X17.5 Y-22 ;
Z-6.5 ;
G10 P11 R0.995 F500 ;
M30 ;
%
>_ MEM **** * 07:07:40

```









11.2.3 Next Block Display Screen

Displays the block currently being executed and the block to be executed next in the MEMORY or MDI mode.

Procedure for displaying the next block display screen

Procedure

- 1 Press function key  .
- 2 Press chapter selection soft key **[NEXT]**.
The block currently being executed and the block to be executed next are displayed.
The screen displays up to 11 G codes specified in the current block and up to 11 G codes specified in the next block.

```

PROGRAM                                O2000 N00130

      (CURRNT)                          (NEXT)
G01 X 17.500                            G39 I -17.500
G17 F 2000                               G42
G41 H 2
G80

>_ S 0 T0000
MEM STRT ***                            16:05:59
[ PRGRM ][ CHECK ][ CURRNT ][ NEXT ][ (OPRT) ]


```

11.2.4 Program Check Screen

Displays the program currently being executed, current position of the tool, and modal data in the MEMORY mode.

Procedure for displaying the program check screen

Procedure

- 1 Press function key  .
- 2 Press chapter selection soft key **[CHECK]**.
The program currently being executed, current position of the tool, and modal data are displayed.

• Display with one-path control

```

PROGRAM                                O2000 N00130

O0010:
G92 G90 X100. Y200. Z50. ;
G00 X0 Y0 Z0 ;
G01 Z250. F1000 ;
(ABSOLUTE)(DIST TO GO) G00 G94
G80
X 0.000 X 0.000 G17 G21 G98
Y 0.000 Y 0.000 G90 G40 G50
Z 0.000 Z 0.000 G22 G49 G67
                                     B
                                     H M
T                                     D
F                                     S
>_ MEM STRT *** 16:05:59 S 0 T0000
[ PRGRM ] [CHECK] [ CURRNT ] [ NEXT ] [ (OPRT) ]

```

• Display with two-path control (7.2"/8.4" LCD)

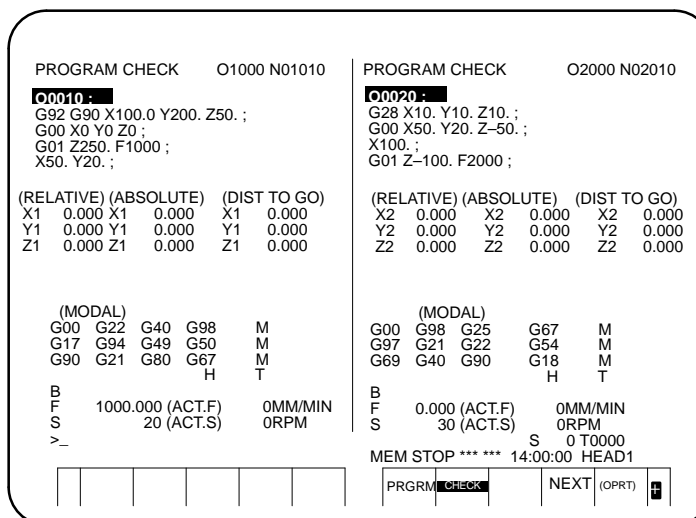
```

PROGRAM                                O2000 N00130

O0010:
G92 G90 X100. Y200.0 Z50. ;
G00 X0 Y0 Z0 ;
G01 Z250. F1000 ;
(ABSOLUTE) (DIST TO GO) G00 G94 G80
X1 0.000 X1 0.000 G17 G21 G98
Y1 0.000 Y1 0.000 G90 G40 G50
Z1 0.000 Z1 0.000 G22 G49 G67
                                     B
                                     H M
T                                     D
F                                     S
MEM STRT *** 16:05:59 HEAD1
[ PRGRM ] [CHECK] [ CURRNT ] [ NEXT ] [ (OPRT) ]

```

- **Display with two path control (9.5"/10.4"LCD)**



Explanations

- **Program display**

The screen displays up to four blocks of the current program, starting from the block currently being executed. The block currently being executed is displayed in reverse video. During DNC operation, however, only three blocks can be displayed.

- **Current position display**

The position in the workpiece coordinate system or relative coordinate system and the remaining distance are displayed. The absolute positions and relative positions are switched by soft keys **[ABS]** and **[REL]**. When there are six or more controlled axes, pressing the **[ABS]** soft key toggles the display between the absolute coordinates for the first to fifth axes and those for the sixth to eighth axes. Pressing the **[REL]** soft key toggles the relative coordinate display in the same way.

- **Modal G codes**

Up to 12 modal G codes are displayed.

- **Display during automatic operation**

During automatic operation, the actual speed, SACT, and repeat count are displayed. The key input prompt (>_) is displayed otherwise.

- **T codes**


Then bit 2 (PCT) of parameter No. 3108 is set to 1, the T codes specified with the PMC (HD.T/NX.T) are displayed instead of those specified in the program. Refer to the FANUC PMC Programming Manual (B-61863E) for details of HD.T/NX.T.

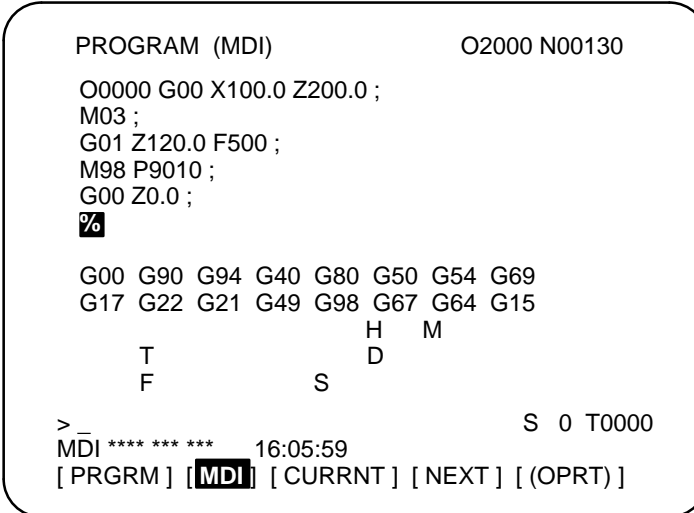
11.2.5 Program Screen for MDI Operation

Displays the program input from the MDI and modal data in the MDI mode.

Procedure for displaying the program screen for MDI operation

Procedure

- 1 Press function key  .
- 2 Press chapter selection soft key **[MDI]**.
The program input from the MDI and modal data are displayed.



```

PROGRAM (MDI)                O2000 N00130
O0000 G00 X100.0 Z200.0 ;
M03 ;
G01 Z120.0 F500 ;
M98 P9010 ;
G00 Z0.0 ;
%
G00 G90 G94 G40 G80 G50 G54 G69
G17 G22 G21 G49 G98 G67 G64 G15
      T           H   M
      F           S   D
>_ MDI **** * 16:05:59 S 0 T0000
[ PRGRM ] [ MDI ] [ CURRNT ] [ NEXT ] [(OPRT)]

```

Explanations




- **MDI operation** See III-4.2 for MDI operation.
- **Modal information** The modal data is displayed when bit 7 (MDL) of parameter 3107 is set to 1. Up to 16 modal G codes are displayed. On the 9.5"/10.4" LCD, however, the contents of the program are displayed on the right half of the screen and the modal data is displayed on the left half of the screen, regardless of this parameter.
- **Displaying during automatic operation** During automatic operation, the actual speed, SACT, and repeat count are displayed. The key input prompt (>_) is displayed otherwise.

11.2.6 Stamping the Machining Time

When a machining program is executed, the machining time of the main program is displayed on the program machining time display screen. The machining times of up to ten main programs are displayed in hours/minutes/seconds. When more than ten programs are executed, data for the oldest programs is discarded.

Procedure for Stamping Machining Time

Procedure 1 Machining time calculation and display

- 1 Select the memory operation mode, then press the  key.
- 2 Select the program screen, then select a program whose machining time is to be calculated.
- 3 Execute the program to perform actual machining.
- 4 When the  key is pressed, or M02 or M30 is executed, the machining time count operation stops. When the machining time display screen is selected, the program number of the stopped main program and its machining time are displayed.
To display the machining time display screen, use the procedure below. (Machining time data can be displayed in any mode and during background editing.)
 - Press the function key .
 - Press the rightmost soft key once or twice to display soft key **[TIME]**.
 - Press soft key **[TIME]**. The machining time display screen appears.

Machining time display screen

PROGRAM (TIME)		O0010 N00002
NO.	TIME	
O0020	12H48M02S	
>_ EDIT **** ** * [TIME] [] [] [] [] [(OPRT)]		16:52:13

Procedure 2 Stamping machining time

- 1 To insert the calculated machining time of a program in a program as a comment, the machining time of the program must be displayed on the machining time display screen. Before stamping the machining time of the program, check that the machining time display screen shows the program number
- 2 Set the part program storage and edit mode or background edit state and select the program screen. Then select the program whose machining time is to be inserted.
- 3 Suppose that the machining time of O0100 is displayed on the machining time display screen. Press soft key **[(OPRT)]** to display the operation soft keys. Then, hold down the rightmost soft key until soft key **[TIME-INSERT]** appears. When soft key **[TIME-INSERT]** is pressed, the cursor moves to the start of the program, and the machining time of the program is inserted after the program number.

```

PROGRAM                                O0100 N00000

O0100 ;
N10 G92 X100. Z10. ;
N20 S1500 M03 ;
N30 G00 X20.5 Z5. T0101 ;
N40 G01 X-10. F25. ;
N50 G02 X-16.5 Z-12. R2. ;
N60 G01 X40. ;
N70 X42. Z-13. ;
N80 Z-50. ;
N90 X44. Z-51. ;
N100 X80. ;

EDIT  * * * * *
[ INS-TM ][           ][           ][           ][           ]

```



```

PROGRAM                                O0100 N00000

O0100 (001H20M01S) ;
N10 G92 X100. Z10. ;
N20 S1500 M03 ;
N30 G00 X20.5 Z5. T0101 ;
N40 G01 Z-10. F25. ;
N50 G02 X16.5 Z-12. R2. ;
N60 G01 X40. ;
N70 X42. Z-13. ;
N80 Z-50. ;
N90 X44. Z-51. ;
N100 X80. ;

EDIT  * * * * *
[ INS-TM ][           ][           ][           ][           ]

```

- 4 If a comment already exists in the block containing the program number of a program whose machining time is to be inserted, the machining time is inserted after the existing comment.

```

PROGRAM                                O0100 O00000
O0100 (SHAFT XSF001) ;
N10 G92 X100. Z10. ;
N20 S1500 M03 ;
N30 G00 X20.5 Z5. T0101 ;
N40 G01 X-10. F25. ;
N50 G02 X16.5 Z-12. R2. ;
N60 G01 X40. ;
    X42. Z-13. ;
N80 Z-50. ;
N90 X44. Z-51. ;
N100 X80. ;

EDIT *** ** * 16:52:13
[ INS-TM ] [   ] [   ] [   ] [   ]

```



```

PROGRAM                                O0100 N00000

O0100 (SHAFT XSF001) O01H20M01S)
N10 G92 X100. Z10. ;
N20 S1500 M03 ;
N30 G00 X20.5 Z5. T0101 ;
N40 G01 Z-10. F25. ;
N50 G02 X16.5 Z-12. R2. ;
N60 G01 X40. ;
N70 X42. Z-13. ;
N80 Z-50. ;
N90 X44. Z-51. ;
N100 X80. ;

EDIT *** ** * 16:52:13
[ INS-TM ] [   ] [   ] [   ] [   ]

```

- 5 The machining time of a program inserted as a comment can be displayed after an existing program comment on the program directory screen.

```

PROGRAM DIRECTORY                      O0001 N00010

    PROGRAM (NUM.)  MEMORY (CHAR.)
USED:             60             3321
FREE:             2              429

O0020 (GEAR XGR001):(012H48M01S)
O0002 (GEAR XGR002):(000H48M01S)
O0010 (BOLT YBT001):(004H16M01S)
O0020 (BOLT YBT002):(000H16M01S)
O0040 (SHAFT XSF001):(001H20M01S)
O0050 (SHAFT XSF002):(002H08M01S)
O0100 (SHAFT XSF011):(002H32M02S)
O0200 (PLATE XPL100):(000H51M01S)

>_
EDIT **** ** * 14:46:09
[ PRGRM ] [ DIR ] [   ] [   ] [ (OPRT) ]

```

Explanations

- **Machining time**

Machining time is counted from the initial start after a reset in memory operation mode to the next reset. If a reset does not occur during operation, machining time is counted from the start to M03 (or M30). However, note that the time during which operation is held is not counted, but the time used to wait for completion of M, S, T, and/or B functions is counted.
- **Stamping the machining time**

The displayed machining time can be inserted (stamped) as a comment in a program stored in memory. Machining time is inserted as a comment after the program number.
- **Program directory**

The machining time inserted after a program number can be displayed on the program directory screen by setting bit 0 (NAM) of parameter No. 3107 to 1. This lets the user know the machining time of each program. This information is useful as reference data when planning processing.

Limitations

- **Alarm**

When program execution is terminated by an alarm during the machining time count, the machining time until the alarm is released is counted.
- **M02**

If the user specifies that M02 does not reset the CNC but returns completion signal FIN to the CNC to restart the program from the beginning successively (with bit 5 (M02) of parameter No. 3404 set to 0), the machining time count stops when M02 returns completion signal FIN.
- **Stamping the machining time**

When the machining time of a program to be stamped is not displayed on the machining time display screen, the machining time cannot be inserted into the program even if soft key **[TIME-INSERT]** is pressed.

- **Program directory**

When the machining time inserted into a program is displayed on the program directory screen and the comment after the program number consists of only machining time data, the machining time is displayed in both the program name display field and machining time display field. If machining time data is inserted into a program as shown below, the program directory screen does not display the data or displays only part of the data.

Example 1: Program directory screen when a program name longer than 16 characters

```

PROGRAM                                O0100 N00000

O0240 (SHAFT XSF301 MATERIAL=FC25)
(001H20M01S);
N10 G92 X100. Z10. ;
N20 S1500 M03 ;
N30 G00 X20.5 Z5. T0101 ;
N40 G01 Z-10. F25. ;
N50 G02 X16.5 Z-12. R2. ;
N60 G01 X40. ;
N70 X42. Z-13. ;
N80 Z-50. ;
N90 X44. Z-51. ;

EDIT *****                               16:52:13
[ INS-TM ] [           ] [           ] [           ] [           ]

```



All characters after the first 16 characters of the program comment are discarded and the machining time display field is left blank.

```

PROGRAM DIRECTORY                       O0001 N00010

PROGRAM (NUM.)    MEMORY (CHAR.)
USED:             60             3321
FREE:             2             429

O0240 (SHAFT XSF301 ) : (           )

>_
EDIT *****                               16:52:13
[ PRGRM ] [ DIR ] [           ] [           ] [(OPRT)]

```

Example 2: Program directory screen when two or more machining times are stamped.

```

PROGRAM                                O0260 N00000

O0260 (SHAFT XSF302) (001H15M59S)
(001H20M01S)
N10 G92 X100. Z10. ;
N20 S1500 M03 ;
N30 G00 X20.5 Z5. T0101 ;
N40 G01 Z-10. F25. ;
N50 G02 X16.5 Z-12. R2. ;
N60 G01 X40. ;
N70 X42. Z-13. ;
N80 Z-50. ;
N90 X44. Z-51. ;

EDIT *** ** * 16:52:13
[ INS-TM ] [   ] [   ] [   ] [   ]
    
```



Only the first machining time is displayed.

```

PROGRAM DIRECTORY                      O0001 N00010

PROGRAM (NUM.)  MEMORY (CHAR.)
USED:           60           3321
FREE:           2           429

O0260 (SHAFT XSF302 ) : (001H15M59S)

>
EDIT *** ** * 16:52:13
[ PRGRM ] [ DIR ] [   ] [   ] [ (OPRT) ]
    
```

Example 3: Program directory screen when inserted machining time data does not conform to the format hhhHmMssS (3-digit number followed by H, 2-digit number followed by M, and 2-digit number followed by S, in this order)

```

PROGRAM                                O0280 N00000

O0280 (SHAFT XSF303) 1H10M59S
N10 G92 X100. Z10. ;
N20 S1500 M03 ;
N30 G00 X20.5 Z5. T0101 ;
N40 G01 Z-10. F25. ;
N50 G02 X16.5 Z-12. R2. ;
N60 G01 X40. ;
N70 X42. Z-13. ;
N80 Z-50. ;
N90 X44. Z-51. ;
N100 X80. ;

EDIT **** ** 16:52:13
[ INS-TM ] [   ] [   ] [   ] [   ]

```



The machining time display field is blank.

```

PROGRAM DIRECTORY                      O0001 N00010

PROGRAM (NUM.)  MEMORY (CHAR.)
USED:           60          3321
FREE:           2          429

O0260 (SHAFT XSF302 ) : (001H15M59S)
O0280 (SHAFT XSF303 ) : (      )




>_
EDIT **** ** 16:52:13
[ PRGRM ] [ DIR ] [   ] [   ] [ (OPRT) ]

```

- **Correcting the machining time**

If an incorrect machining time is calculated (such as when a reset occurs during program execution), reexecute the program to calculate the correct machining time. If the machining time display screen displays multiple programs with the same program number, select the machining time of the latest program number for insertion into the program.

11.3 SCREENS DISPLAYED BY FUNCTION KEY (IN THE EDIT MODE)


This section describes the screens displayed by pressing function key  in the EDIT mode. Function key  in the EDIT mode can display the program editing screen and the program list screen (displays memory used and a list of programs). Pressing function key  in the EDIT mode can also display the conversational graphics programming screen and the floppy file directory screen. See III-9 and 10 for the program editing screen and conversational graphics programming screen. See III-8 for the floppy file directory screen.

11.3.1 Displaying Memory Used and a List of Programs

Displays the number of registered programs, memory used, and a list of registered programs.

Procedure for displaying memory used and a list of programs

Procedure

- 1 Select the **EDIT** mode.
- 2 Press function key .
- 3 Press chapter selection soft key **[DIR]**.

```
PROGRAM DIRECTORY          O0001 N00010
```

```
      PROGRAM (NUM.)  MEMORY (CHAR.)
USED:           60           3321
FREE:            2           429
```

```
O0010 O0001 O0003 O0002 O0555 O0999
O0062 O0004 O0005 O1111 O0969 O6666
O0021 O1234 O0588 O0020 O0040
```

```
> _          S 0 T0000
MDI **** * 16:05:59
[ PRGRM ] [ DIR ] [      ] [ C.A.P. ] [(OPRT)]
```

Explanations

- **Details of memory used**

PROGRAM NO. USED

PROGRAM NO. USED : The number of the programs registered (including the subprograms)

FREE : The number of programs which can be registered additionally.

MEMORY AREA USED

MEMORY AREA USED : The capacity of the program memory in which data is registered (indicated by the number of characters).

FREE : The capacity of the program memory which can be used additionally (indicated by the number of characters).

- **Program library list**

Program Nos. registered are indicated.

Also, the program name can be displayed in the program table by setting parameter NAM (No. 3107#0) to 1.

```

PROGRAM DIRECTORY          O0001 N00010
      PROGRAM (NUM.)  MEMORY (CHAR.)
USED:          60          3321
FREE:           2          429

O0001 (MACRO-GCODE.MAIN)
O0002 (MACRO-GCODE.SUB1)
O0010 (TEST-PROGRAM.ARTHMETIC NO.1)
O0020 (TEST-PROGRAM.F10-MACRO)
O0040 (TEST-PROGRAM.OFFSET)
O0050
O0100 (INCH/MM CONVERT CHECK NO.1)
O0200 (MACRO-MCODE.MAIN)

> _
EDIT **** * 16:05:59
[ PRGRM ] [ DIR ] [ ] [ C.A.P. ] [ (OPRT) ]

```

- **Program name**

Always enter a program name between the control out and control in codes immediately after the program number.

Up to 31 characters can be used for naming a program within the parentheses. If 31 characters are exceeded, the exceeded characters are not displayed.

Only program number is displayed for the program without any program name.

○ □□□□ (ΔΔΔΔ...Δ) ;
 | |
 Program number Program name (up to 31 characters)

- **Software series**

Software series of the system is displayed.

It is used for maintenance ; user is not required this information.

- **Order in which programs are displayed in the program library list**

Programs are displayed in the same order that they are registered in the program library list. However, if bit 4 (SOR) of parameter 3107 is set to 1, programs are displayed in the order of program number starting from the smallest one.

- **Order in which programs are registered**

When no program has been deleted from the list, each program is registered at the end of the list.

If some programs in the list were deleted, then a new program is registered, the new program is inserted in the empty location in the list created by the deleted programs.

Example) When bit 4 (SOR) of parameter 3107 is 0

1. After clearing all programs, register programs O0001, O0002, O0003, O0004, and O0005 in this order. The program library list displays the programs in the following order:

O0001, O0002, O0003, O0004, O0005

2. Delete O0002 and O0004. The program library list displays the programs in the following order:

O0001, O0003, O0005

3. Register O0009. The program library list displays the programs in the following order:

O0001, O0009, O0003, O0005

11.3.2 Displaying a Program List for a Specified Group



In addition to the normal listing of the numbers and names of CNC programs stored in memory, programs can be listed in units of groups, according to the product to be machined, for example.

To assign CNC programs to the same group, assign names to those programs, beginning each name with the same character string.

By searching through the program names for a specified character string, the program numbers and names of all the programs having names including that string are listed.

Procedure for Displaying a Program List for a Specified Group

Procedure

- 1 Enter EDIT or background editing mode.
- 2 Press the  function key.
- 3 Press the  function key or **[DIR]** soft key to display the program list.

```
PROGRAM DIRECTORY          O0001 N00010
      PROGRAM (NUM.)      MEMORY (CHAR.)
USED:           60          3321
FREE:           2          429
```

```
O0020 (GEAR-1000 MAIN)
O0040 (GEAR-1000 SUB-1)
O0060 (SHAFT-2000 MAIN)
O0100 (SHAFT-2000 SUB-1)
O0200 (GEAR-1000 SUB-2)
O1000 (FRANGE-3000 MAIN)
O2000 (GEAR-1000 SUB-3)
O3000 (SHAFT-2000 SUB-2)
```

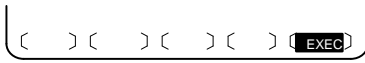
```
>_
EDIT **** * 16:52:13
[ PRGRM ] [ DIR ] [ ] [ ] [ (OPRT) ]
```

```
[G-ED] [O-SRH] [ ] [ ] [ ] [GROUP]
[ ] [ ] [ ] [NAME] [PR-GRP] [ ] [ ]
```

- 4 Press the **[(OPRT)]** operation soft key.
- 5 Press the **[GROUP]** operation soft key.
- 6 Press the **[NAME]** operation soft key.
- 7 Enter the character string corresponding to the group for which a search is to be made, using the MDI keys. No restrictions are imposed on the length of a program name. Note, however, that search is made based on only the first 32 characters.

Example: To search for those CNC programs having names that begin with character string “GEAR-1000,” enter the following:

```
>GEAR-1000*_
```



- 8 Pressing the **[EXEC]** operation soft key displays the group-unit program list screen, listing all those programs whose name includes the specified character string.

```

PROGRAM DIRECTORY (GROUP)   O0001 N00010
      PROGRAM (NUM.)   MEMORY (CHAR.)
USED:           60           3321
FREE:           2           429

O0020 (GEAR-1000 MAIN)
O0040 (GEAR-1000 SUB-1)
O0200 (GEAR-1000 SUB-2)
O2000 (GEAR-1000 SUB-3)

>_
EDIT **** * 16:52:25
[ PRGRM ] [ DIR ] [ ] [ ] [ (OPRT) ]

```

**[Group-unit program list screen displayed
when a search is made for "GEAR-1000*"]**

When the program list consists of two or more pages, the pages can be changed by using a page key.

Explanations

- * and ?

In the above example, the asterisk (*) must not be omitted. The asterisk indicates an arbitrary character string (wild card specification).

“GEAR-1000*” indicates that the first nine characters of the target program names must be “GEAR-1000,” followed by an arbitrary character string. If only “GEAR-1000” is entered, a search is made only for those CNC programs having the nine-character name “GEAR-1000.”

A question mark (?) can be used to specify a single arbitrary character. For example, entering “????-1000” enables a search to be made for programs having names which start with four arbitrary characters, followed by “-1000”.

[Example of using wild cards]

(Entered character string)	(Group for which the search will be made)
(a) “*”	CNC programs having any name
(b) “*ABC”	CNC programs having names which end with “ABC”
(c) “ABC*”	CNC programs having names which start with “ABC”
(d) “*ABC*”	CNC programs having names which include “ABC”
(e) “?A?C”	CNC programs having four-character names, the second and fourth characters of which are A and C, respectively
(f) “??A?C”	CNC programs having five-character names, the third and fifth characters of which are A and C, respectively
(g) “123*456”	CNC programs having names which start with “123” and which end with “456”

- **When the specified character string cannot be found**
- **Holding the group for which a search is made**
- **Group for which previous search was made**

If no program is located as a result of a search for an entered character string, warning message “DATA NOT FOUND” is displayed on the program list screen.


A group-unit program list, generated by a search, is held until the power is turned off or until another search is performed.

After changing the screen from the group-unit program list to another screen, pressing the **[PR-GRP]** operation soft key (displayed in step 6) redisplay the group-unit program list screen, on which the program names for the previously searched group are listed. Using this soft key eliminates the need to enter the relevant character string again to redisplay the search results after changing the screen.

Examples

Assume that the main programs and subprograms for machining gear part number 1000 all have names which include character string “GEAR-1000.” The numbers and names of those programs can be listed by searching through the names of all CNC programs for character string “GEAR-1000.” This function facilitates the management of the CNC programs stored in large-capacity memory.

11.4 SCREENS DISPLAYED BY FUNCTION KEY

Press function key  to display or set tool compensation values and other data.

This section describes how to display or set the following data:

1. Tool offset value
2. Settings
3. Run time and part count
4. Workpiece origin offset value
5. Custom macro common variables
6. Pattern menu and pattern data
7. Software operator's panel
8. Tool life management data

This section also describes measurement of tool length and the sequence number comparison and stop function.


The pattern menu, pattern data, software operator's panel, and tool life management data depend on the specifications of the machine tool builder. See the manual issued by the machine tool builder for details.

11.4.1 Setting and Displaying the Tool Offset Value


Tool offset values, tool length offset values, and cutter compensation values are specified by D codes or H codes in a program. Compensation values corresponding to D codes or H codes are displayed or set on the screen.

Procedure for setting and displaying the tool offset value

Procedure

- 1 Press function key  .

For the two-path control, select the tool post for which tool compensation values are to be displayed with the tool post selection switch.

- 2 Press chapter selection soft key **[OFFSET]** or press  several times until the tool compensation screen is displayed.
The screen varies according to the type of tool offset memory.

OFFSET		O0001 N00000	
NO.	DATA	NO.	DATA
001	1.000	009	0.000
002	-2.000	010	-7.500
003	0.000	011	12.000
004	5.000	012	-20.000
005	0.000	013	0.000
006	0.000	014	0.000
007	0.000	015	0.000
008	0.000	016	0.000
ACTUAL POSITION (RELATIVE)			
X	0.000	Y	0.000
Z	0.000		

> _
MDI **** *
[OFFSET] [SETING] [WORK] [] [(OPRT)]

Tool offset memory A

OFFSET		O0001 N00000		
NO.	GEOM(H)	WEAR(H)	GEOM(D)	WEAR(D)
001		0.000	0.000	0.000
002	-1.000	0.000	0.000	0.000
003	0.000	0.000	0.000	0.000
004	20.000	0.000	0.000	0.000
005	0.000	0.000	0.000	0.000
006	0.000	0.000	0.000	0.000
007	0.000	0.000	0.000	0.000
008	0.000	0.000	0.000	0.000
ACTUAL POSITION (RELATIVE)				
X	0.000	Y	0.000	
Z	0.000			

> _
MDI **** *
[OFFSET] [SETING] [WORK] [] [(OPRT)]

Tool offset memory C

- 3 Move the cursor to the compensation value to be set or changed using page keys and cursor keys, or enter the compensation number for the compensation value to be set or changed and press soft key **[NO.SRH]**.
- 4 To set a compensation value, enter a value and press soft key **[INPUT]**. To change the compensation value, enter a value to add to the current value (a negative value to reduce the current value) and press soft key **[+INPUT]**. Or, enter a new value and press soft key **[INPUT]**.

Explanations

- **Decimal point input**

A decimal point can be used when entering a compensation value.

- **Other setting method**

An external input/output device can be used to input or output a tool offset value. See III-8. A tool length offset value can be set by measuring the tool length as described in the next subsection.

- **Tool offset memory**

There are tool offset memories A, B, and C, which are classified as follows:

Tool offset memory A

D codes and H codes are treated the same. Tool geometry compensation and tool wear compensation are treated the same.

Tool offset memory B

D codes and H codes are treated the same. Tool geometry compensation and tool wear compensation are treated differently.

Tool offset memory C

D codes and H codes are treated differently. Tool geometry compensation and tool wear compensation are treated differently.

- **Disabling entry of compensation values**

The entry of compensation values may be disabled by setting bit 0 (WOF) and bit 1 (GOF) of parameter 3290 (not applied to tool offset memory A). And then, the input of tool compensation values from the MDI can be inhibited for a specified range of offset numbers. The first offset number for which the input of a value is inhibited is set in parameter No. 3294. The number of offset numbers, starting from the specified first number, for which the input of a value is inhibited is set in parameter No. 3295. Consecutive input values are set as follows:

- 1) When values are input for offset numbers, starting from one for which input is not inhibited to one for which input is inhibited, a warning is issued and values are set only for those offset numbers for which input is not inhibited.
- 2) When values are input for offset numbers, starting from one for which input is inhibited to one for which input is not inhibited, a warning is issued and no values are set.

● 9.5"/10.4" LCD

OFFSET				O0000	N00000
NO.	DATA	NO.	DATA	ACTUAL POSITION (RELATIVE)	
001	0.000	017	0.000		
002	0.000	018	0.000	X-12345.678	
003	0.000	019	0.000	Y-12345.678	
004	0.000	020	0.000	Z-12345.678	
005	0.000	021	0.000	A-12345.678	
006	0.000	022	0.000	B-12345.678	
007	0.000	023	0.000	C-12345.678	
008	0.000	024	0.000	7-12345.678	
009	0.000	025	0.000	8-12345.678	
010	0.000	026	0.000		
011	0.000	027	0.000		
012	0.000	028	0.000		
013	0.000	029	0.000		
014	0.000	030	0.000		
015	0.000	031	0.000		
016	0.000	032	0.000		

>_ MDI ***** 20:45:00

OFFSET SETTING (OPRT)

Tool offset memory A

OFFSET				O0000	N00000
NO.	(LENGTH)	(RADIUS)	ACTUAL POSITION		(RELATIVE)
	GEOM	WEAR	GEOM	WEAR	
001	0.000	0.000	0.000	0.000	X 0.000
002	0.000	0.000	0.000	0.000	Y 0.000
003	0.000	0.000	0.000	0.000	Z 0.000
004	0.000	0.000	0.000	0.000	A 0.000
005	0.000	0.000	0.000	0.000	B 0.000
006	0.000	0.000	0.000	0.000	C 0.000
007	0.000	0.000	0.000	0.000	7 0.000
008	0.000	0.000	0.000	0.000	8 0.000
009	0.000	0.000	0.000	0.000	
010	0.000	0.000	0.000	0.000	
011	0.000	0.000	0.000	0.000	
012	0.000	0.000	0.000	0.000	
013	0.000	0.000	0.000	0.000	
014	0.000	0.000	0.000	0.000	
015	0.000	0.000	0.000	0.000	
016	0.000	0.000	0.000	0.000	

>_ MDI ***** 20:45:00

OFFSET SETTING (OPRT)

Tool offset memory C


11.4.2 Tool Length Measurement

The length of the tool can be measured and registered as the tool length offset value by moving the reference tool and the tool to be measured until they touch the specified position on the machine.



The tool length can be measured along the X-, Y-, or Z-axis.




Procedure for tool length measurement

Procedure

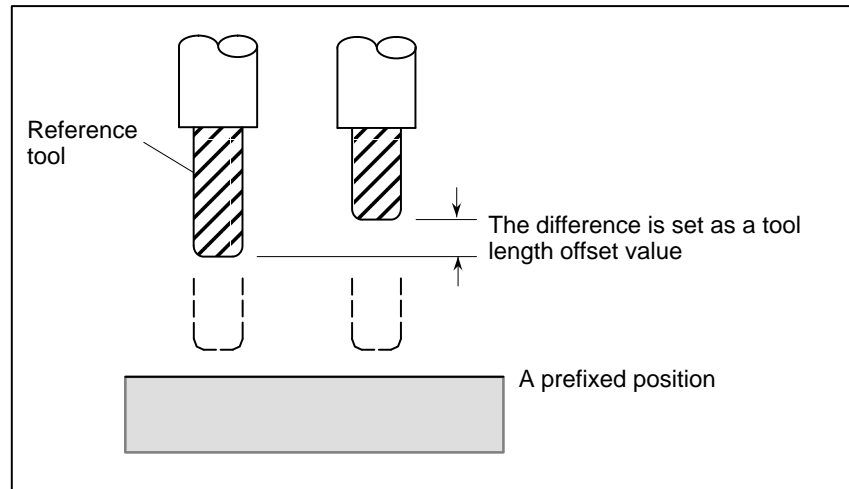
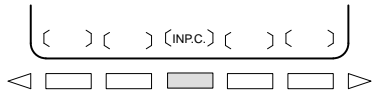
- 1 Use manual operation to move the reference tool until it touches the specified position on the machine (or workpiece.)
- 2 Press function key  several times until the current position display screen with relative coordinates is displayed.

ACTUAL POSITION(RELATIVE)		O1000 N00010
X	123.456	
Y	363.233	
Z	0.000	
RUN TIME 0H15M		PART COUNT 5
ACT.F 3000 MM/M		CYCLE TIME 0H 0M38S
		S 0 T0000
MEM STRT MTN ***		09:06:35
[ABS] [REL] [ALL] [HNDL] [OPRT]		

- 3 Reset the relative coordinate for the Z-axis to 0 (see III-11.1.2 for details).
- 4 Press function key  several times until the tool compensation screen is displayed.
- 5 Use manual operation to move the tool to be measured until it touches the same specified position. The difference between the length of the reference tool and the tool to be measured is displayed in the relative coordinates on the screen.
- 6 Move the cursor to the compensation number for the target tool (the cursor can be moved in the same way as for setting tool compensation values).
- 7 Press the address key  .

If either  or  key is depressed instead of  key, the X or Y axis relative coordinate value is input as an tool length compensation value.

- 8 Press the soft key **[INP.C.]**. The Z axis relative coordinate value is input and displayed as an tool length offset value.



11.4.3 Displaying and Entering Setting Data




Data such as the TV check flag and punch code is set on the setting data screen. On this screen, the operator can also enable/disable parameter writing, enable/disable the automatic insertion of sequence numbers in program editing, and perform settings for the sequence number comparison and stop function.

See III-10.2 for automatic insertion of sequence numbers.

See III-11.4.4 for the sequence number comparison and stop function. This subsection describes how to set data.

Procedure for setting the setting data

Procedure

- 1 Select the **MDI** mode.
- 2 Press function key  .
- 3 Press soft key [**SETTING**] to display the setting data screen. This screen consists of several pages.
Press page key  or  until the desired screen is displayed.
An example of the setting data screen is shown below.

```
SETTING (HANDY)                                O0001 N00000
```

```
PARAMETER WRITE = 1(0:DISABLE 1:ENABLE)
TV CHECK         = 0 (0:OFF 1:ON)
PUNCH CODE      = 1 (0:EIA 1:ISO)
INPUT UNIT      = 0 (0:MM 1:INCH)
I/O CHANNEL     = 0 (0-3:CHANNEL NO.)
SEQUENCE NO.    = 0 (0:OFF 1:ON)
TAPE FORMAT     = 0 (0:NO CNV 1:F15)
SEQUENCE STOP   =          0 (PROGRAM NO.)
SEQUENCE STOP   =          0 (SEQUENCE NO.)
```

```
> _
MDI **** * 16:05:59
[ OFFSET ] [ SETTING ] [ WORK ] [      ] [(OPRT)]
```

```
SETTING (HANDY)                                O0001 N00000
```

```
MIRROR IMAGE   X = 0(0:OFF 1:ON)
MIRROR IMAGE   Y = 0 (0:OFF 1:ON)
MIRROR IMAGE   Z = 0 (0:OFF 1:ON)
```

```
> _
MDI **** * 16:05:59
[ OFFSET ] [ SETTING ] [ WORK ] [      ] [(OPRT)]
```

- 4 Move the cursor to the item to be changed by pressing cursor keys



- 5 Enter a new value and press soft key **[INPUT]**.

Contents of settings

- **PARAMETER WRITE** Setting whether parameter writing is enabled or disabled.
0 : Disabled
1 : Enabled

- **TV CHECK** Setting to perform TV check.
0 : No TV check
1 : Perform TV check

- **PUNCH CODE** Setting code when data is output through reader puncher interface.
0 : EIA code output
1 : ISO code output

- **INPUT UNIT** Setting a program input unit, inch or metric system
0 : Metric
1 : Inch



- **I/O CHANNEL** Using channel of reader/puncher interface.
0 : Channel 0
1 : Channel 1
2 : Channel 2
3 : Channel 3

- **SEQUENCE STOP** Setting of whether to perform automatic insertion of the sequence number or not at program edit in the EDIT mode.
0 : Does not perform automatic sequence number insertion.
1 : Perform automatic sequence number insertion.

- **TAPE FORMAT** Setting the F15 tape format conversion.
0 : Tape format is not converted.
1 : Tape format is converted.
See II. PROGRAMMING for the F15 tape format.

- **SEQUENCE STOP** Setting the sequence number with which the operation stops for the sequence number comparison and stop function and the number of the program to which the sequence number belongs

- **MIRROR IMAGE** Setting of mirror image ON/OFF for each axes.
0 : Mirror image off
1 : Mirror image on




- **Others** Page key  or  can also be pressed to display the SETTING (TIMER) screen. See III-11.4.5 for this screen.

11.4.4 Sequence Number Comparison and Stop

If a block containing a specified sequence number appears in the program being executed, operation enters single block mode after the block is executed.

Procedure for sequence number comparison and stop

Procedure

- 1 Select the **MDI** mode.
- 2 Press function key  .
- 3 Press chapter selection soft key **[SETTING]**.
- 4 Press page key  or  several times until the following screen is displayed.

```

SETTING (HANDY)                                00001 N00000

PARAMETER WRITE = 1 (0:DISABLE 1:ENABLE)
TV CHECK        = 0 (0:OFF 1:ON)
PUNCH CODE      = 1 (0:EIA 1:ISO)
INPUT UNIT      = 0 (0:MM 1:INCH)
I/O CHANNEL     = 0 (0-3:CHANNEL NO.)
SEQUENCE NO.    = 0 (0:OFF 1:ON)
TAPE FORMAT     = 0 (0:NO CNV 1:F10/11)
SEQUENCE STOP   = 0 (PROGRAM NO.)
SEQUENCE STOP   = 11 (SEQUENCE NO.)

>_
MDI **** *
[OFFSET] [SETTING] [WORK] [ ] [(OPRT)]
16:05:59

```

- 5 Enter in (PROGRAM NO.) for SEQUENCE STOP the number (1 to 9999) of the program containing the sequence number with which operation stops.
- 6 Enter in (SEQUENCE NO.) for SEQUENCE STOP (with five or less digits) the sequence number with which operation is stopped.
- 7 When automatic operation is executed, operation enters single block mode at the block containing the sequence number which has been set.

Explanations

- **Sequence number after the program is executed**

After the specified sequence number is found during the execution of the program, the sequence number set for sequence number compensation and stop is decremented by one. When the power is turned on, the setting of the sequence number is 0.
- **Exceptional blocks**

If the predetermined sequence number is found in a block in which all commands are those to be processed within the CNC control unit, the execution does not stop at that block.

Example

```
N1 #1=1 ;  
N2 IF [#1 EQ 1] GOTO 08 ;  
N3 GOTO 09 ;  
N4 M98 P1000 ;  
N5 M99 ;
```

In the example shown above, if the predetermined sequence number is found, the execution of the program does not stop.
- **Stop in the canned cycle**

If the predetermined sequence number is found in a block which has a canned-cycle command, the execution of the program stops after the return operation is completed.
- **When the same sequence number is found several times in the program**

If the predetermined sequence number appears twice or more in a program, the execution of the program stops after the block in which the predetermined sequence number is found for the first time is executed.
- **Block to be repeated a specified number of times**

If the predetermined sequence number is found in a block which is to be executed repeatedly, the execution of the program stops after the block is executed specified times.




11.4.5 Displaying and Setting Run Time, Parts Count, and Time

Various run times, the total number of machined parts, number of parts required, and number of machined parts can be displayed. This data can be set by parameters or on this screen (except for the total number of machined parts and the time during which the power is on, which can be set only by parameters).

This screen can also display the clock time. The time can be set on the screen.

Procedure for Displaying and Setting Run Time, Parts Count and Time

Procedure

- 1 Select the MDI mode.
- 2 Press function key  .
- 3 Press chapter selection soft key **[SETTING]**.
- 4 Press page key  or  several times until the following screen is displayed.

SETTING (TIMER)	O0001 N00000
PARTS TOTAL =	14
PARTS REQUIRED =	0
PARTS COUNT =	23
POWER ON	= 4H 31M
OPERATING TIME	= 0H 0M 0S
CUTTING TIME	= 0H 37M 5S
FREE PURPOSE	= 0H 0M 0S
CYCLE TIME	= 0H 0M 0S
DATE =	1993/07/05
TIME=	11:32:52
> _	
MDI **** * * * *	16:05:59
[OFFSET] [SETTING] [WORK] [] [(OPRT)]	

- 5 To set the number of parts required, move the cursor to PARTS REQUIRED and enter the number of parts to be machined.
- 6 To set the clock, move the cursor to DATE or TIME, enter a new date or time, then press soft key **[INPUT]**.

Display items

- PARTS TOTAL

This value is incremented by one when M02, M30, or an M code specified by parameter 6710 is executed. This value cannot be set on this screen. Set the value in parameter 6712.

- PARTS REQUIRED

It is used for setting the number of machined parts required. When the “0” is set to it, there is no limitation to the number of parts. Also, its setting can be made by the parameter (NO. 6713).

- **PARTS COUNT** This value is incremented by one when M02, M30, or an M code specified by parameter 6710 is executed. The value can also be set by parameter 6711. In general, this value is reset when it reaches the number of parts required. Refer to the manual issued by the machine tool builder for details.
- **POWER ON** Displays the total time which the power is on. This value cannot be set on this screen but can be preset in parameter 6750.
- **OPERATING TIME** Indicates the total run time during automatic operation, excluding the stop and feed hold time.
This value can be preset in parameter 6751 or 6752.
- **CUTTING TIME** Displays the total time taken by cutting that involves cutting feed such as linear interpolation (G01) and circular interpolation (G02 or G03). This value can be preset in parameter 6753 or 6754.
- **FREE PURPOSE** This value can be used, for example, as the total time during which coolant flows. Refer to the manual issued by the machine tool builder for details.
- **CYCLE TIME** Indicates the run time of one automatic operation, excluding the stop and feed hold time. This is automatically preset to 0 when a cycle start is performed at reset state. It is preset to 0 even when power is removed.
- **DATA and TIME** Displays the current date and time. The date and time can be set on this screen.

Limitations

- **Usage** When the command of M02 or M30 is executed, the total number of machined parts and the number of machined parts are incremented by one. Therefore, create the program so that M02 or M30 is executed every time the processing of one part is completed. Furthermore, if an M code set to the parameter (NO. 6710) is executed, counting is made in the similar manner. Also, it is possible to disable counting even if M02 or M30 is executed (parameter PCM (No. 6700#0) is set to 1). For details, see the manual issued by machine tool builders.

Restrictions

- **Run time and part count settings** Negative value cannot be set. Also, the setting of “M” and “S” of run time is valid from 0 to 59.
Negative value may not be set to the total number of machined parts.
- **Time settings** Neither negative value nor the value exceeding the value in the following table can be set.


Item	Maximum value	Item	Maximum value
Year	2085	Hour	23
Month	12	Minute	59
Day	31	Second	59

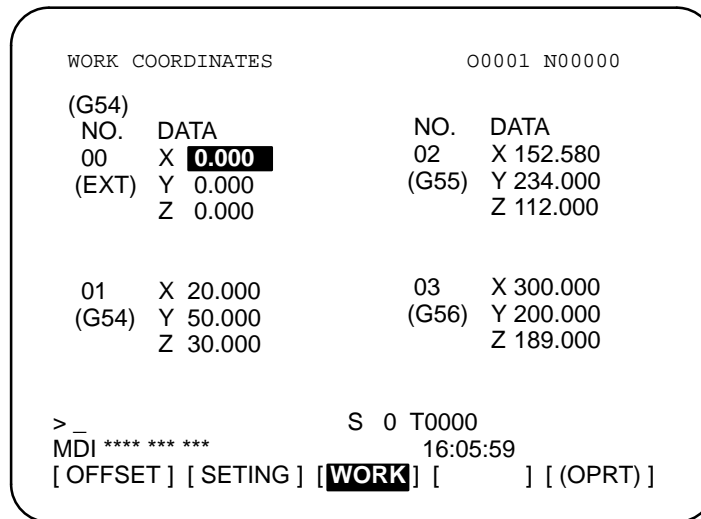
11.4.6 Displaying and Setting the Workpiece Origin Offset Value



Displays the workpiece origin offset for each workpiece coordinate system (G54 to G59, G54.1 P1 to G54.1 P48 and G54.1 P1 to G54.1 P300) and external workpiece origin offset. The workpiece origin offset and external workpiece origin offset can be set on this screen.

Procedure for Displaying and Setting the Workpiece Origin Offset Value

Procedure

- 1 Press function key  .
- 2 Press chapter selection soft key **[WORK]**.
The workpiece coordinate system setting screen is displayed.



- 3 The screen for displaying the workpiece origin offset values consists of two or more pages. Display a desired page in either of the following two ways:
 - Press the page up  or page down  key.
 - Enter the workpiece coordinate system number (0 : external workpiece origin offset, 1 to 6: workpiece coordinate systems G54 to G59, P1 to P48 : workpiece coordinate systems G54.1 P1 to G54.1 P48, P1 to P300 : workpiece coordinate systems G54.1 P1 to G54.1 P300) and press operation selection soft key **[NO.SRH]**.
- 4 Turn off the data protection key to enable writing.
- 5 Move the cursor to the workpiece origin offset to be changed.
- 6 Enter a desired value by pressing numeric keys, then press soft key **[INPUT]**. The entered value is specified in the the workpiece origin offset value. Or, by entering a desired value with numeric keys and pressing soft key **[+INPUT]**, the entered value can be added to the previous offset value.
- 7 Repeat **5** and **6** to change other offset values.
- 8 Turn on the data protection key to disable writing.

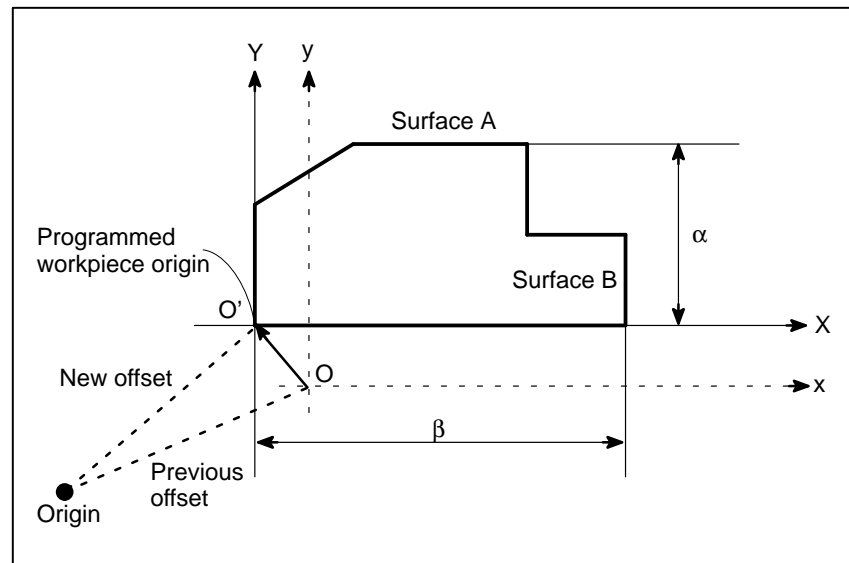
11.4.7 Direct Input of Measured Workpiece Origin Offsets

This function is used to compensate for the difference between the programmed workpiece coordinate system and the actual workpiece coordinate system. The measured offset for the origin of the workpiece coordinate system can be input on the screen such that the command values match the actual dimensions.

Selecting the new coordinate system matches the programmed coordinate system with the actual coordinate system.

Procedure for Direct Inputting of Measured Workpiece Origin Offsets

Procedure



- 1 When the workpiece is shaped as shown above, position the reference tool manually until it touches surface A of the workpiece.
- 2 Retract the tool without changing the Y coordinate.
- 3 Measure distance α between surface A and the programmed origin of the workpiece coordinate system as shown above.
- 4 Press function key OFFSET
SETTING .

- 5 To display the workpiece origin offset setting screen, press the chapter selection soft key **[WORK]**.

WORK COORDINATES (G54)				O1234 N56789			
NO.		DATA		NO.		DATA	
00	X	0.000		02	X	0.000	
(EXT)	Y	0.000		(G55)	Y	0.000	
	Z	0.000			Z	0.000	
01	X	0.000		03	X	0.000	
(G54)	Y	0.000		(G56)	Y	0.000	
	Z	0.000			Z	0.000	
> Z100.				S 0 T0000			
MDI **** * * * *				16:05:59			
[NO.SRH] [MEASUR] [] [+INPUT] [INPUT]			

- 6 Position the cursor to the workpiece origin offset value to be set.
- 7 Press the address key for the axis along which the offset is to be set (Y-axis in this example).
- 8 Enter the measured value (α) then press the **[MEASUR]** soft key.
- 9 Move the reference tool manually until it touches surface B of the workpiece.
- 10 Retract the tool without changing the X coordinate.
- 11 Measure distance β then enter the distance at X on the screen in the same way as in steps 7 and 8.

Limitations

- **Consecutive input**
- **During program execution**

Offsets for two or more axes cannot be input at the same time.

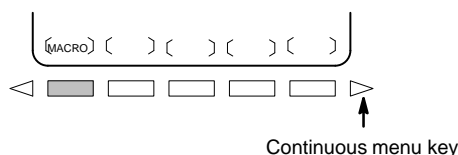
This function cannot be used while a program is being executed.



11.4.8 Displaying and Setting Custom Macro Common Variables

Displays common variables (#100 to #149 or #100 to #199, and #500 to #531 or #500 to #999) on the CRT. When the absolute value for a common variable exceeds 99999999, ***** is displayed. The values for variables can be set on this screen. Relative coordinates can also be set to variables.










Procedure for displaying and setting custom macro common variables

Procedure



- 1 Press function key  .
- 2 Press the continuous menu key  , then press chapter selection soft key **[MACRO]**. The following screen is displayed:

VARIABLE		O0001 N00000	
NO.	DATA	NO.	DATA
100	1000.000	108	0.000
101	0.000	109	40000.000
102	-50000.000	110	153020.00
103	0.000	111	0001.000
104	1238501.0	112	0.000
105	0.000	113	20000.000
106	0.000	114	0.000
107	0.000	115	0.000
ACTUAL POSITION (RELATIVE)			
X	0.000	Y	0.000
Z	0.000		
> _		S 0 T0000	
MDI **** * * * *		16:05:59	
[NO.SRH]	[]	[INP.C.]	[] [INPUT]

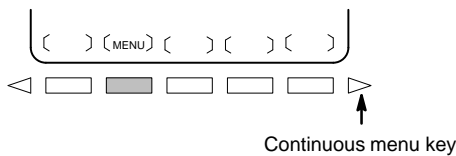
- 3 Move the cursor to the variable number to set using either of the following methods:
 - Enter the variable number and press soft key **[NO.SRH]**.
 - Move the cursor to the variable number to set by pressing page keys  and/or  and cursor keys  ,  ,  , and/or  .
- 4 Enter data with numeric keys and press soft key **[INPUT]**.
- 5 To set a relative coordinate in a variable, press address key  ,  , or  , then press soft key **[INP.C.]**.
- 6 To set a blank in a variable, just press soft key **[INPUT]**. The value field for the variable becomes blank.



11.4.9 Displaying Pattern Data and Pattern Menu

This subsection uses an example to describe how to display or set machining menus (pattern menus) created by the machine tool builder. Refer to the manual issued by the machine tool builder for the actual pattern menus and pattern data. See II. PROGRAMMING for the pattern data entry function.

Procedure for displaying the pattern data and the pattern menu

Procedure




- 1 Press function key  .
- 2 Press the continuous menu key  , then press chapter selection soft key **[MENU]**.
The following screen (pattern menu screen) is displayed:

```

MENU : HOLE PATTERN                O0000 N00000
  1. TAPPING
  2. DRILLING
  3. BORING
  4. POCKET
  5. BOLT HOLE
  6. LINE ANGLE
  7. GRID
  8. PECK
  9.
 10.

>_
MDI **** * 16:05:59
[ MACRO ] MENU [ OPR ] [   ] [(OPRT)]

```

- 3 Enter a pattern number and press soft key **[SELECT]**.
In this example, press  , then press **[SELECT]**.


The following screen (pattern data screen) is displayed:

```

VAR. : BOLT HOLE                O0001 N00000
NO.  NAME          DATA      COMMENT
500  TOOL          0.000
501  STANDARD X    0.000    *BOLT HOLE
502  STANDARD Y    0.000    CIRCLE*
503  RADIUS        0.000    SET PATTERN
504  S. ANGL      0.000    DATA TO VAR.
505  HOLES NO     0.000    NO.500-505.
506  0.000
507  0.000

ACTUAL POSITION (RELATIVE)
  X  0.000          Y  0.000
>_ Z  0.000
MDI **** * 16:05:59
[ OFFSET ] [ SETING ] [   ] [   ] [(OPRT)]

```

- 4 Enter necessary pattern data and press .
- 5 After entering all necessary data, enter the **MEMORY** mode and press the cycle start button to start machining.

Explanations

- **Explanation of the pattern menu screen**

HOLE PATTERN : Menu title

An optional character string can be displayed within 12 characters.

BOLE HOLE : Pattern name

An optional character string can be displayed within 10 characters.

The machine tool builder should program character strings of menu title and pattern name by custom macro, and load them into the program memory.

- **Explanation of the pattern data screen**

BOLT HOLE : Pattern data title

An optional character string can be displayed within 12 characters.

TOOL : Variable name

An optional character string can be displayed within 10 characters.

BOLT HOLE CIRCLE : Comment statement

An optional character string comment can be displayed up to 12 characters/line by 8 lines.

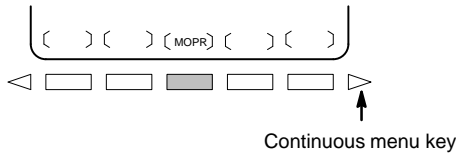
The machine tool builder should program the character strings of variable name and comment statement by custom macro, and load them into the program memory.





11.4.10 Displaying and Setting the Software Operator's Panel

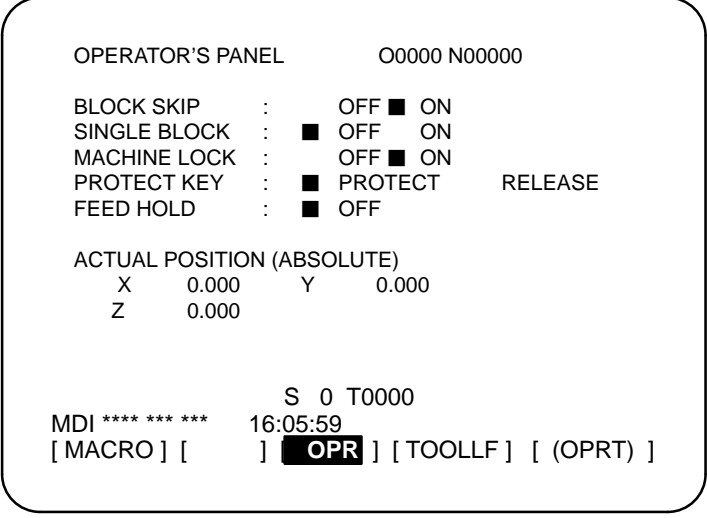
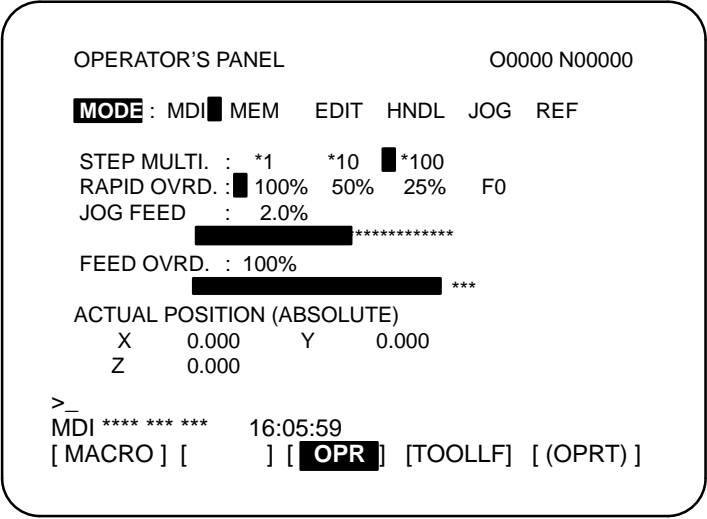
With this function, functions of the switches on the machine operator's panel can be controlled from the CRT/MDI panel.
Jog feed can be performed using numeric keys.







Procedure for displaying and setting the software operator's panel








Procedure



- 1 Press function key  .
- 2 Press the continuous menu key , then press chapter selection soft key **[OPR]**.
- 3 The screen consists of several pages.
Press page key  or  until the desired screen is displayed.



- 4 Move the cursor to the desired switch by pressing cursor key  or  .
- 5 Push the cursor move key  or  to match the mark  to an arbitrary position and set the desired condition.
- 6 Press one of the following arrow keys to perform jog feed. Press the  key together with an arrow key to perform jog rapid traverse.

Explanations

- **Valid operations**

The valid operations on the software operator's panel are shown below. Whether to use the CRT/MDI panel or machine operator's panel for each group of operations can be selected by parameter 7200.

Group1 : Mode selection

Group2 : Selection of jog feed axis, jog rapid traverse

Group3 : Selection of manual pulse generator feed axis, selection of manual pulse magnification x1, x10, x100

Group4 : Jog federate, federate override, rapid traverse override

Group5 : Optional block skip, single block, machine lock, dry run

Group6 : Protect key

Group7 : Feed hold

- **Display**

The groups for which the machine operator's panel is selected by parameter 7200 are not displayed on the software operator's panel.

- **Screens on which jog feed is valid**

When the CRT indicates other than the software operator's panel screen and diagnostic screen, jog feed is not conducted even if the arrow key is pushed.

- **Jog feed and arrow keys**

The feed axis and direction corresponding to the arrow keys can be set with parameters (Nos. 7210 to 7217).

- **General purpose switches**

Eight optionally definable switches are added as an extended function of the software operator's panel. The name of these switches can be set by parameters (Nos. 7220 to 7283) as character strings of max. 8 characters. For the meanings of these switches, refer to the manual issued by machine tool builder.





11.4.11 Displaying and Setting Tool Life Management Data

Tool life data can be displayed to inform the operator of the current state of tool life management. Groups which require tool changes are also displayed. The tool life counter for each group can be preset to an arbitrary value. Tool data (execution data) can be reset or cleared. To register or modify tool life management data, a program must be created and executed. See Explanations in this section for details.

When bit 6 (EXT) of parameter 6801 is 1, extended tool life management applies. See III-11.4.12.

Procedure for display and setting the tool life management data

Procedure

- 1 Press function key  .
- 2 Press the continuous menu key  to display chapter selection soft key **[TOOLLF]**.
- 3 Press softkey **[TOOLLF]**.
- 4 One page displays data on two groups. Pressing page key  or  successively displays data on the following groups. Up to four group Nos., for which the Tool Change signal is being issued, are displayed at the bottom of each page. An arrow shown in the figure is displayed for five or more groups, if exists.

```

TOOL LIFE DATA :                               O3000 N00060
                                           SELECTED GROUP 000
GROUP 001 : LIFE 0150  COUNT 0000
              0034 0078  0012  0056
              0090 0035  0026  0061
              0000 0000  0000  0000
              0000 0000  0000  0000



              GROUP 002 : LIFE 1400  COUNT 0000
              0062 0024  0044  0074
              0000 0000  0000  0000
              0000 0000  0000  0000
              0000 0000  0000  0000
              TO BE CHANGED : 003 004 005 006 —>

```

```

> _
MEM **** * 16:05:59
[ MACRO ][   ] [ OPR ] [TOOLLF] [(OPRT)]

```

- 5 To display the page containing the data for a group, enter the group number and press soft key **[NO.SRH]**.
The cursor can be moved to an arbitrary group by pressing cursor key  or  .
- 6 To change the value in the life counter for a group, move the cursor to the group, enter a new value (four digits), and press **[INPUT]**. The life counter for the group indicated by the cursor is preset to the entered value. Other data for the group is not changed.
- 7 To reset the tool data, move the cursor on the group to reset, then press the **[(OPRT)]**, **[CLEAR]**, and **[EXEC]** soft keys in this order.
All execution data for the group indicated by the cursor is cleared together with the marks (@, #, or *).

Explanations

- Display contents

```

TOOL LIFE DATA :                                O3000 N00060
                                           SELECTED GROUP 000
GROUP 001      LIFE  0150  COUNT  0007
  * 0034      # 0078      @ 0012      0056
    0090      0035      0026      0061
    0000      0000      0000      0000
    0000      0000      0000      0000

GROUP 002 :      LIFE  1400  COUNT  0000
  0062      0024      0044      0074
  0000      0000      0000      0000
  0000      0000      0000      0000
  0000      0000      0000      0000

TO BE CHANGED : 003 004 005 006 ——>
>_
MEM **** * 16:05:59
[ MACRO ][      ] [ OPR ] [TOOLLF] [(OPRT) ]

```

- The first line is the title line.
- In the second line the group number of the current command is displayed.
When there is no group number of the current command, 0 is displayed.
- In lines 3 to 7 the tool life data of the group is displayed.
The third line displays group number, life and the count used.
The life count is chosen by parameter LTM (No. 6800#2) as either minutes(or hours) or number of times used.
In lines 4 to 5, tool numbers are displayed. In this case, the tool is selected in the order, 0034 → 0078 → 0012 → 0056 → 0090 ...
The meaning of each mark before the tool numbers is :
* : Shows the life has finished.
: Shows that the skip command has been accepted.
@ : Shows that the tool is currently being used.
The life counter counts for tool with @.
“*” is displayed when the next command is issued by the group to which it belongs.
- Lines 8 to 12 are next group life data to the group displayed in lines 3 to 7.
- In the thirteenth line the group number when the tool change signal is being emitted is displayed. The group number display appears in ascending order. When it cannot be completely displayed, “——>” is displayed.

11.4.12 Displaying and Setting Extended Tool Life Management

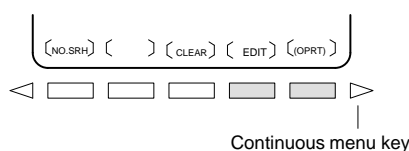
The extended tool life management function provides more detailed data display and more data editing functions than the ordinary tool life management function.



Moreover, if the tool life is specified in units of time, the time which has been set can be increased or reduced (life count override).

When bit 6 (EXT) of parameter 6801 is set to 0, the ordinary tool life management function applies. See III-11.4.11.

Procedure for displaying and Setting extended tool life management

Procedure



- 1 Press function key  .
- 2 Press the continuous menu key  to display chapter selection soft key **[TOOLLF]**.
- 3 Press soft key **[TOOLLF]** to display the tool life management data screen.
On this screen, place the cursor on a group of items to be edited.
- 4 Press soft key **[(OPRT)]**.
- 5 Press soft key **[EDIT]**.
The extended tool life management data editing screen for the group indicated by the cursor is the displayed.

```

LIFE DATA  EDIT  GROUP : 001 O0010 N00001
TYPE       : 1 (1:C 2:M)      NEXT GROUP: ***
LIFE       : 9800             USE GROUP  : ***
COUNT     : 6501             SELECTED GROUP : 001

NO.   STATE   T-CODE   H-CODE   D-CODE
01    *       0034   011     005
02    #       0078   000     033
03    @       0012   004     018
04    *       0056   000     000
05    *       0090   000     000
06    *       0076   023     012

> _
MDI **** * 16:05:59
[INSERT] [DELETE] [STATE] [END] [INPUT]

```

Tool life management data can be edited as follows:

- 6 Select the **MDI** mode.
- 7 Stop, pause, or reset the CNC by the feed hold, single block stop, or reset operation (tool life management data cannot be edited while data is set by a program.).
The following editing can be performed. See each step for details:
 - Setting the life count type, life value, current life count, and tool data (T, H, or D code) : **7-1**
 - Adding a tool group : **7-2**
 - Adding a tool number (T code) : **7-3**

- Deleting a tool group : 7-4
- Deleting tool data (T, H, or D code) : 7-5
- Skipping a tool : 7-6
- Clearing the life count (resetting the life) : 7-7

7-1 Setting the life count type, life value, current life count, and tool data (T, H, or D code)

- (1) Position the cursor on the data item to be changed.
- (2) Enter a desired value.
- (3) Press the softkey **[INPUT]**.

7-2 Adding a tool group

- (1) In step 3, select a group for which no data is set and display the editing screen.
- (2) Enter tool numbers.
- (3) Press soft key **[INSERT]**.

- In this case, the type of the life counter is determined by the setting of LTM (No. 6800#2), and 0 is set in both the life expectancy and life counter.
- 0 is set in both the H code and D code.
- The cursor remains on the tool number until the T code is specified.

7-3 Adding a tool number

- (1) Move the cursor to the tool data (T, H, or D code) after which a new number is to be added.
- (2) Enter the tool number.
- (3) Press soft key **[INSERT]**.

Example), Inserting tool No. 1500 between No. 1 and No. 2.

NO.	STATE	T-CODE	H-CODE	D-CODE
01	*	0034	11	5
02	#	0078	0	33

Move the cursor to 5 in D-CODE column and press soft key **[INSERT]**.

NO.	STATE	T-CODE	H-CODE	D-CODE
01	*	0034	11	5
02		1500	0	0
03	#	0078	0	33

7-4 Deleting a tool group

- (1) In step 3, position the cursor on a group to be deleted and display the editing screen.
- (2) Press soft key **[DELETE]**.
- (3) Press soft key **[GROUP]**.
- (4) Press soft key **[EXEC]**.

7-5 Deleting tool data (T, H, or D code)

- (1) Position the cursor on the data item (T, H, or D code) to be deleted.
- (2) Press soft key **[DELETE]**.
- (3) Press soft key **[<CRSR>]**.

· The line containing the cursor is deleted.

· When a tool with mark @ (being used) is deleted, mark @ shifts to the tool whose life has expired most recently or which has been skipped.

In this case, marks * and # are displayed in reverse video.  

7-6 Skipping a tool

- (1) Position the cursor on the data item (T, H, or D code) for the tool to be skipped.
- (2) Press soft key **[STATE]**.
- (3) Press soft key **[SKIP]**.

7-7 Clearing the life count (resetting the life)

- (1) Position the cursor on the data item (T, H, or D code) of the tool to be cleared.
- (2) Press soft key **[STATE]**.
- (3) Press soft key **[CLEAR]**.

- 8** To complete the edit operation, press soft key **[END]**.
The tool life management screen is displayed again.

Explanations

- Displays

```

LIFE DATA EDIT    GROUP : 001 O0010 N00001
TYPE   : 1 (1:C 2:M)    NEXT GROUP: ***
LIFE   : 9800           USE GROUP  : ***
COUNT : 6501           SELECTED GROUP : 001

NO.  STATE  T-CODE   H-CODE   D-CODE
01   *      0034    011     005
02   #      0078    000     033
03   @      0012    004     018
04   *      0056    000     000
05   *      0090    000     000
06   *      0076    023     012

> _
MDI **** * 16:05:59
[ INSERT ] [ DELETE ] [ STATE ] [ END ] [ INPUT ]
    
```

NEXT GROUP :

Number of the tool group whose life is to be calculated by the next M06 command

USE GROUP :

Number of the tool group whose life is being calculated

SELECTED GROUP :

Number of the tool group whose life is being calculated or was calculated last

TYPE: 1: Life count is represented in units of cycles.

TYPE: 2 : Life count is represented in units of minutes.

LIFE : Life expectancy

COUNT : Life counter

STATE : State of the tool

Tool state	In use	Not in use
Available	@	_(Space)
Skip	#	#
Skipped	w / * (Note)	*

NOTE

When bit 3 (EMD) of parameter 6801 is set to 0, @ is displayed until the next tool is selected.

T-CODE : Tool number

H-CODE : H code

D-CODE : D code

- **Tool life management screen**

When the extended tool life management function is provided, the following items are added to the tool life management screen:

- NEXT: Tool group to be used next
- USE: Tool group in use
- Life counter type for each tool group (C: Cycles, M: Minutes)

```

TOOL LIFE DATA                                O0001 N00001
NEXT *** USE *** SELECTED GROUP: 001
GROUP 001: C LIFE 9800 COUNT 6501
  *0034 #0078 @0012 *0056
  0090 *0076
GROUP 002: C LIFE 9800 COUNT 1001
  *0011 #0022 *0201 *0144
  *0155 #0066 0176 0188
  0019 0234 0007 0112
  0156 0090 0016 0232
TO BE CHANGED : 006 012 013 014 →

> _ S 0 T0000
MDI **** * 16:05:59
[ NO.SRH ] [ ] [ CLEAR ] [ EDIT ] [ INPUT ]

```

- **Life count override**

The tool life count can be overridden provided that the life counter is indicated in units of minutes and LFV (bit 2 of parameter 6801) is 1. Override values can be specified using the override switch on the operator's panel within the range from 0 to 99.9. If 0 is specified, tool life is not counted. If the count of actual cutting time is less than 4 seconds, the override value is invalid.

Example

When cutting is performed for 10 minutes with an override of 0.1, the tool life counter counts one minute.

- **Display of the mark indicating that the life of a tool has expired**

The symbol * for indicating that the life of a tool has expired can be displayed either when the machine starts using the next tool or when the life of the tool actually expires. Either of these methods can be selected using EMD (bit 3 of parameter 6801).

- **Influence of changes in data**

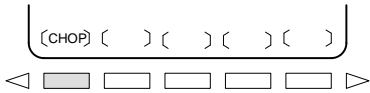
- Modification of the life expectancy or life counter does not affect the tool states or tool change signal.
- When the type of the life counter is changed, be sure to change the life expectancy and life count as well.



11.4.13 Displaying and Setting Chopping Data

Chopping data, including the reference point (R point), upper dead point, and chopping feedrate, can be displayed and set by using the chopping screen.

Procedure for displaying and setting chopping data

Procedure



- 1 Press the  function key.
- 2 Press the continuous menu key  several times until **[CHOP]** is displayed.
- 3 Press the **[CHOP]** soft key.

The following chopping screen appears:

CHOPPING PARAMETER	O1000 N10000
R (REFERENCE) POINT =	50.000
UPPER DEAD POINT =	40.000
LOWER DEAD POINT =	10.000
CHOPPING FEED RATE =	2000
> _ MDI **** * [] [] [TEACH] [+INPUT] [INPUT]	

Explanations

● Numerical input

- Position the cursor to the item to be set.
- Enter data, then press the **[INPUT]** soft key.
- To append the entered data to the current data, press the **[+INPUT]** soft key.

The set data is displayed.

● Teaching the position

The reference point (R point), upper dead point, and lower dead point can be set by teaching the current position (absolute coordinates).

- Move the current position (absolute coordinates) along the chopping axis to the position to be taught.
- Position the cursor to the item to be set.
- Press the **[TEACH]** soft key, then the **[EXEC]** soft key.

The current position (absolute coordinates) is set for that item.

● G81.1

The data for each item displayed on the chopping screen can also be changed by executing a G81.1 command.

Limitations

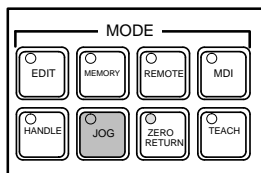
- **Chopping feedrate** If bit 7 (CHPX) of parameter No. 8360 is set to 1, the chopping feedrate cannot be set by using the chopping screen.
- **Data setting conditions** The chopping screen can be used to set chopping data regardless of the current mode, even during automatic or manual operation that includes chopping. If the level of memory protection signal KEY2 (G046#4) is currently low, however, chopping data cannot be set.

11.4.14 Tool Length/Workpiece Origin Measurement B

To enable measurement of the tool length, the following functions are supported: automatic measurement of the tool length by using a program command (G37) (automatic tool length measurement, described in Section II.14.2) and measurement of the tool length by manually moving the tool until it touches a reference position, such as the workpiece top surface (tool length measurement, described in Subsection III.11.4.2). In addition to these functions, tool length/workpiece origin measurement B is supported to simplify the tool length measurement procedure, thus facilitating and reducing the time required for machining setup. This function also facilitates the measurement of the workpiece origin offsets. This function allows the operator to specify T/M code commands or reference position return, by means of a manual numeric command, while the tool length offset measurement screen is displayed.

Procedure for measuring the tool length offset value

Procedure



The tool length offset value can be measured by manually moving the tool until it touches the workpiece or a reference block. For details of this operation, refer to the manual supplied by the machine tool builder.

- 1 Move the tool to the tool change position by means of manual reference position return, for example.
- 2 Press mode selection switch HANDLE or JOG.
- 3 Set the tool offset value measurement mode switch on the machine operator's panel to ON. The tool length offset measurement screen, shown below, appears and "OFST" blinks in the status display at the bottom of the screen.

The tool length offset measurement screen varies slightly depending on whether tool length offset memory A, B (geometry compensation and wear compensation are treated differently), or C (geometry compensation and wear compensation are treated differently, and cutter compensation and tool length compensation are treated differently) is used.

OFFSET		01234 N12345	
No.	GEOMETRY		(MACHINE)
001	100.000		X-12345.678
002	200.000		Y-12345.678
003	300.000		Z-12345.678
004	400.000		A-12345.678
005	500.000		B-12345.678
006	600.000		C-12345.678
007	700.000		U-12345.678
008	800.000		V-12345.678
009	900.000	(T)	12345678
010	-999.999	(M)	12345678
		(HM)	-12345.678
>			
JOG **** ** *		ALM 13:14:15	OFST
[OFFSET]	[SETTING]	[WORK]	[(OPRT)]

Tool length offset measurement screen for tool offset memory A


OFFSET		01234 N12345	
No.	GEOMETRY	WEAR	(MACHINE)
001	100.000	100.000	X-12345.678
002	200.000	200.000	Y-12345.678
003	300.000	300.000	Z-12345.678
004	400.000	400.000	A-12345.678
005	500.000	500.000	B-12345.678
006	600.000	600.000	C-12345.678
007	700.000	700.000	U-12345.678
008	800.000	800.000	V-12345.678
009	900.000	900.000	(T) 12345678
010	-999.999	-999.999	(M) 12345678
			(HM) -12345.678
>			
JOG **** ** *		ALM 13:14:15	OFST
[OFFSET]	[SETTING]	[WORK]	[(OPRT)]

Tool length offset measurement screen for tool offset memory B

OFFSET		01234 N12345	
		(LENGTH)	(MACHINE)
No.	GEOMETRY	WEAR	X-12345.678
001	100.000	100.000	Y-12345.678
002	200.000	200.000	Z-12345.678
003	300.000	300.000	A-12345.678
004	400.000	400.000	B-12345.678
005	500.000	500.000	C-12345.678
006	600.000	600.000	U-12345.678
007	700.000	700.000	V-12345.678
008	800.000	800.000	(T) 12345678
009	900.000	900.000	(M) 12345678
010	-999.999	-999.999	(HM) -12345.678
>			
JOG **** ** *		ALM 13:14:15	OFST
[OFFSET]	[SETTING]	[WORK]	[(OPRT)]

Tool length offset measurement screen for tool offset memory C

NOTE

Pressing the  key resets the displayed T and M addresses to 0. Once MEM or MDI mode has been selected, however, the modal T and M codes are displayed.

- 4 Use the numeric keys to enter the distance from the base measurement surface to the measurement surface, then press soft key **[HM INPUT]** to set the distance. For details of the measurement surface and base measurement surface, see Explanations, below.
- 5 Select the tool for which the tool length offset value is to be measured. While "OFST" is blinking at the bottom of the tool length offset measurement screen, a T code or M code can be specified in manual handle feed or jog feed mode (manual numeric command). First, enter Tttt (where tttt is a T code number), then press the cycle start button on the machine operator's panel or MDI panel. The Tttt command is executed, thus selecting the tool to be measured. Then, usually, enter the M06 command to move the tool to the spindle position. Once the tool for which the tool length offset is to be measured has been selected at the spindle position, position the cursor to the tool offset number with which the tool length offset for the selected tool is to be stored. The positioning of the cursor to the offset number is usually done by the operator. Some machines, however, automatically position the cursor to an appropriate tool offset number upon the completion of tool selection, if bit 5 (QNI) of parameter No. 5005 is set to 1.
- 6 Perform manual handle feed or jog feed to move the tool until it touches the measurement surface of the workpiece or reference block.
- 7 Press soft key **[MEASURE B]**. The tool length offset is stored in the tool offset memory. If tool offset memory B or C is being used, the tool length offset is set as the tool geometry value, while 0 is set as the tool wear offset. The cursor remains positioned to the set tool offset number. To automatically advance the cursor to the next tool offset number upon the completion of the setting an offset, press soft key **[MEASURE B+]**, instead of **[MEASURE B]**.
- 8 Once the tool length offset has been set, the tool is automatically moved to the tool change position.
- 9 This completes tool length offset measurement for a single tool. To measure the tool length offsets of other tools, repeat steps 5 to 8.
- 10 Once the tool length offsets of all tools have been measured, set the tool offset measurement mode switch on the machine operator's panel to OFF. The "OFST" blinking indication is cleared from the bottom of the screen.

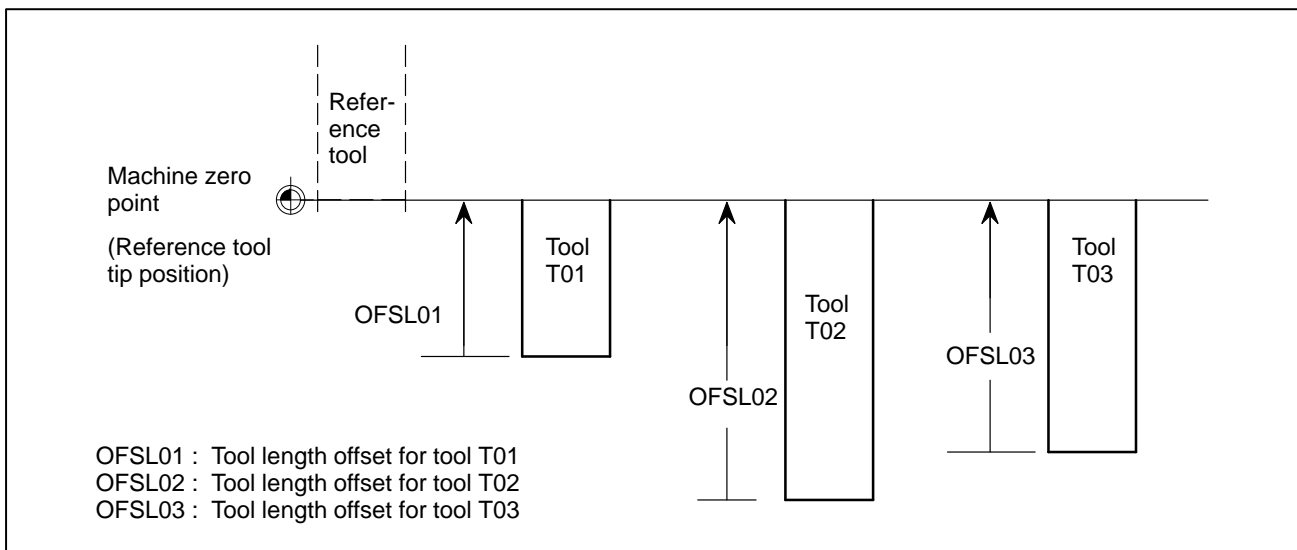
Explanations

• Definition of tool length offset value

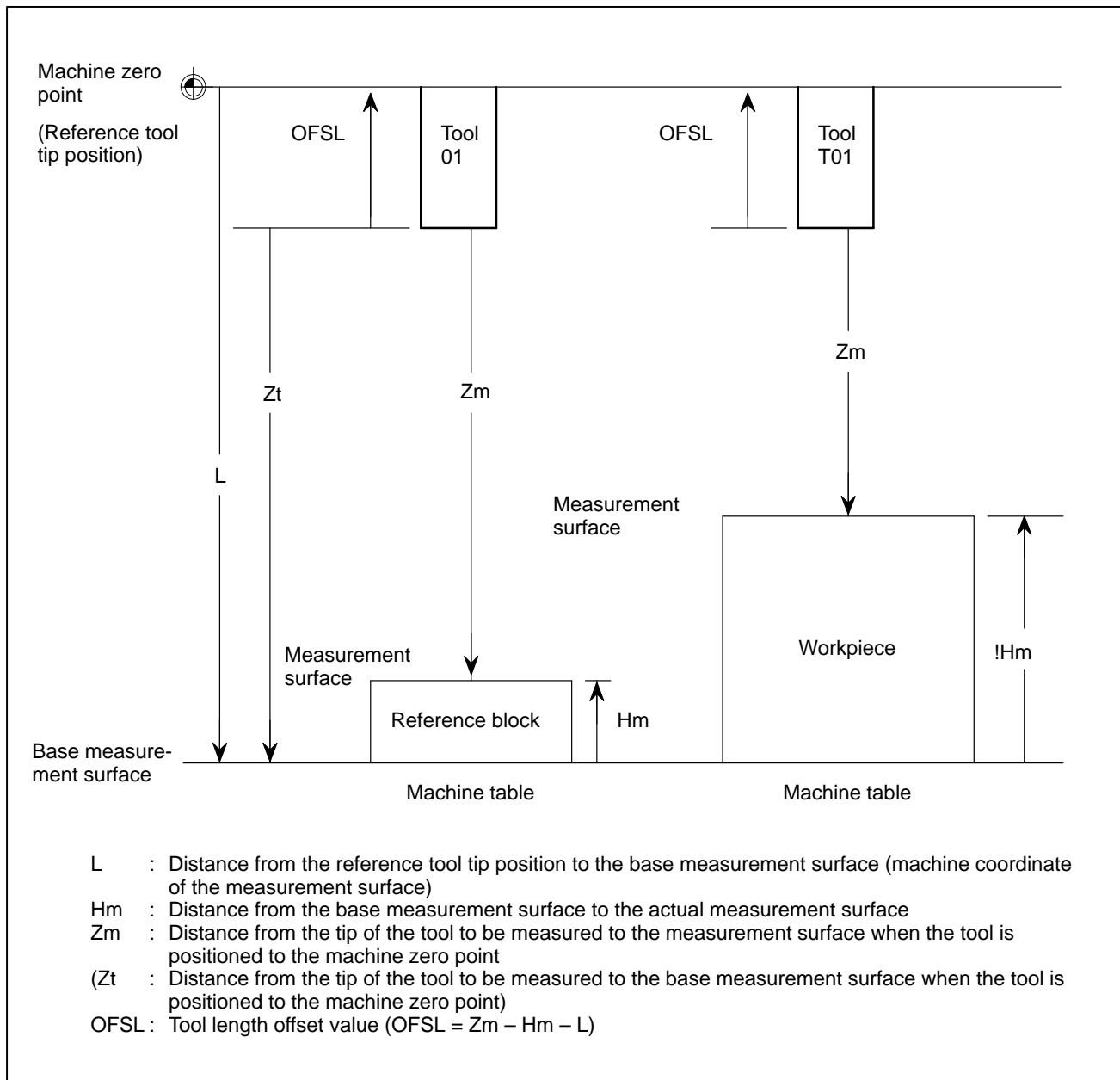
In general, the tool length offset value can be defined in either of the following two ways. Both methods are based on the same concept: The difference between the tip position of the tool and that of a reference tool is used as the tool offset.

(1) Definition 1

The first method involves using the actual tool length as the tool length offset. In this case, the reference tool is an imaginary tool which has its tip at the machine zero point when the machine is positioned to the Z-axis machine zero point. The difference between the tip position of the tool to be measured and that of the reference tool, that is, the distance along the Z-axis from the machine zero point to the tip of the tool when the machine is positioned to the Z-axis machine zero point, is defined as the tool length offset.



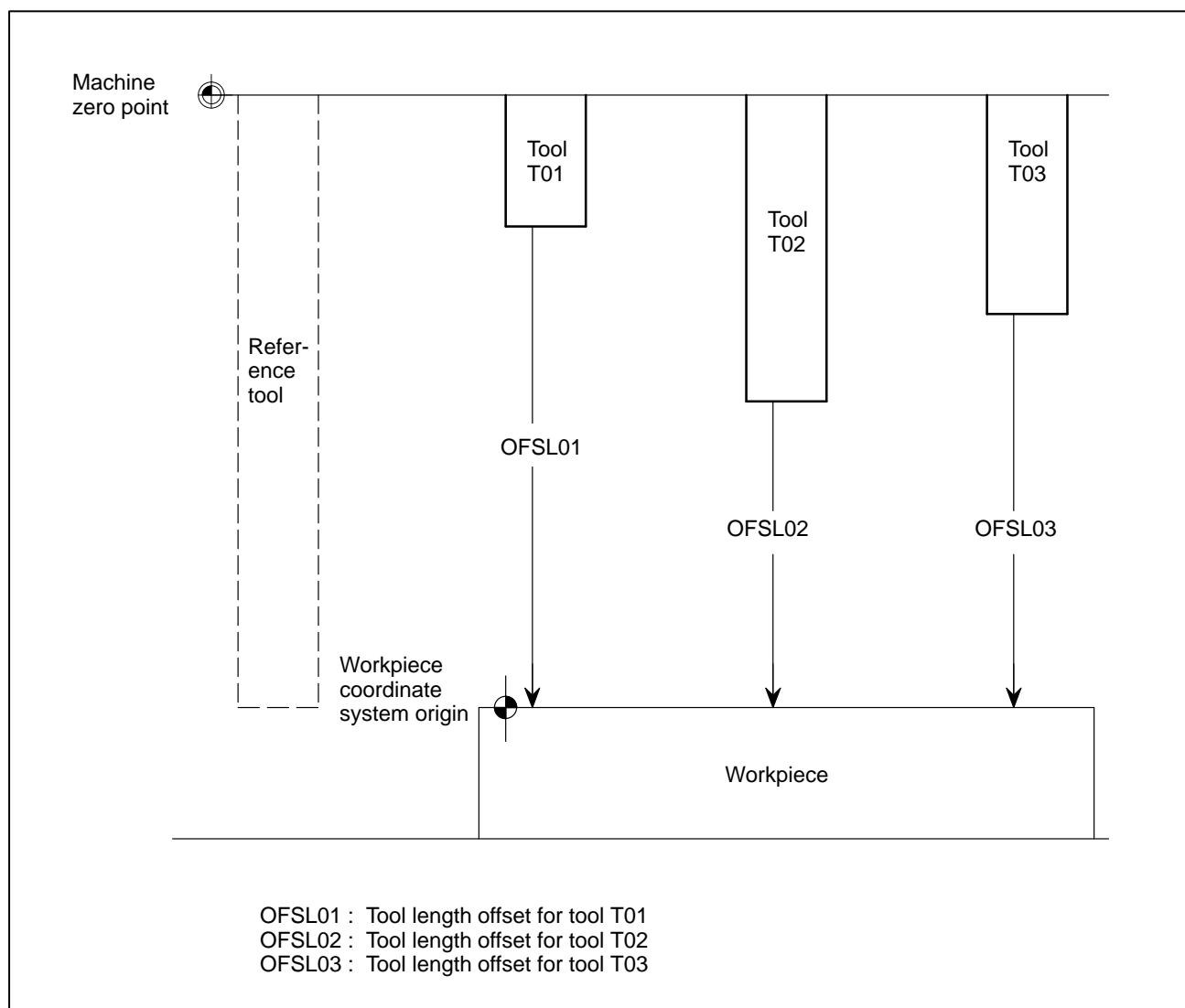
Also, with this function, the tool is manually moved by means of jog feed until its tip touches the top surface of the workpiece or reference block. This surface is called the measurement surface. Assume that the top surface of the machine's table is set as the measurement surface, although this is actually not allowed because the machine would be damaged. In such a case, distance L from the machine zero point to the machine table top surface is specific to that machine. Set distance L in a parameter (No. 5022). Assume Z_t to be the machine coordinate of the tool at the position where it would touch the machine table top surface if that surface were set as the measurement surface. The tool length offset (OFSL) can then be easily calculated from L and Z_t . Because the machine table top surface cannot actually be used as the measurement surface, however, that surface is defined as the base measurement surface and the distance from the base measurement surface to the actual measurement surface, that is, the height of the workpiece or reference block (H_m) must be set. The tool length offset value (OFSL) can thus be obtained from the formula shown below.



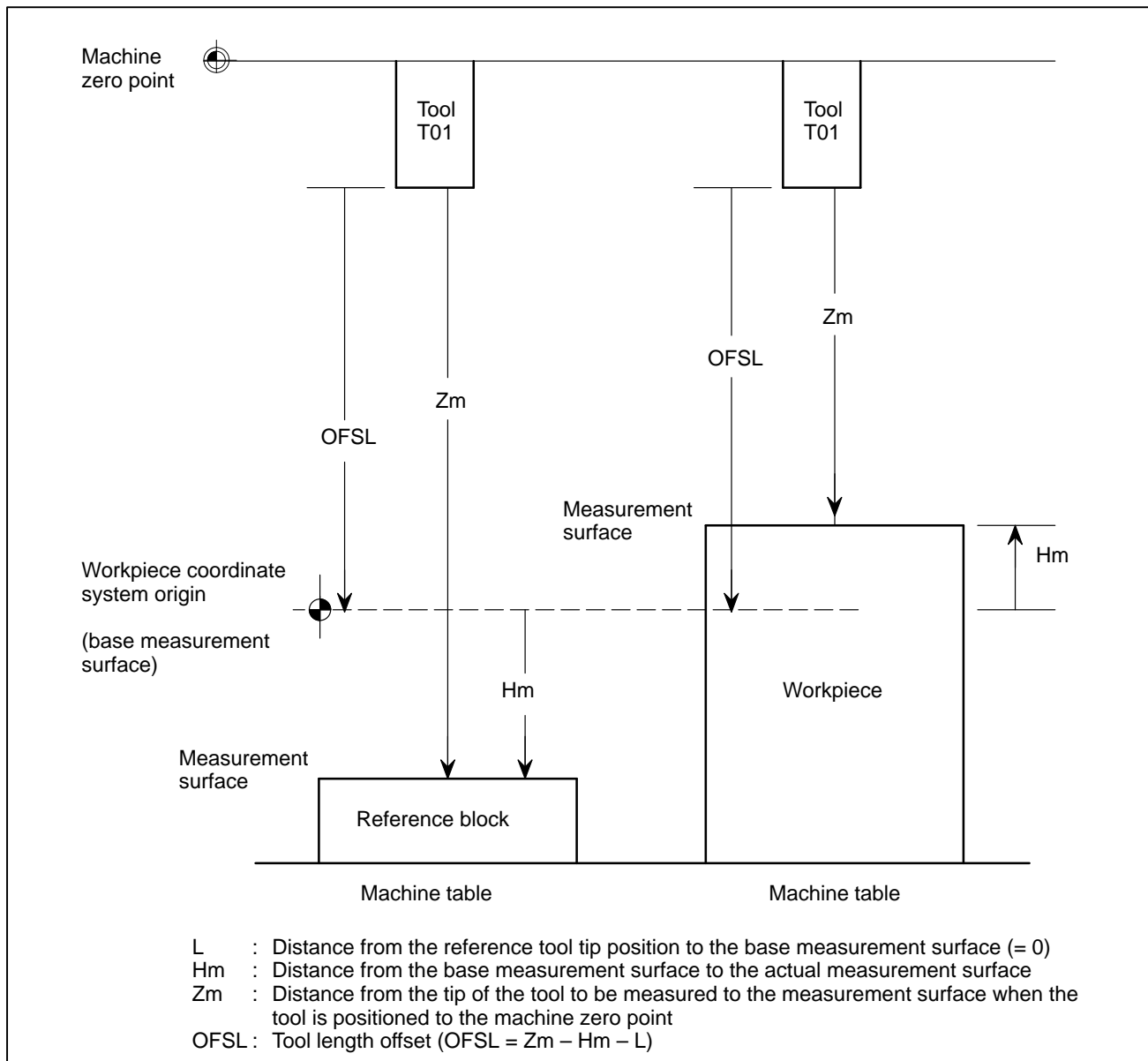
Defining the actual tool length as the tool length offset has the advantage of eliminating the need for remeasuring, even if the workpiece is changed, provided the tool is not worn. Another advantage is that the tool length offset need not be re-set when multiple workpieces are machined. In this case, assign a workpiece coordinate system to each workpiece, using G54 to G59, and set the workpiece origin offset for each workpiece. For an explanation of how to measure the workpiece origin offset, see "Measuring the workpiece origin offset", below.

(2) Definition 2

In the second definition method, the tool length offset is the distance from the tool tip position to the workpiece coordinate system origin when the machine is positioned to the Z-axis zero point. A tool length offset defined in this way will be equal to the difference between the length of the tool to be measured and that of the reference tool, in the same way as with definition 1. The reference tool for definition 2 is, however, an imaginary tool which has a tip at the workpiece coordinate system origin when the machine is positioned to the Z-axis zero point.



The base measurement surface for this definition is located at the workpiece coordinate system origin. Because the tip of the reference tool is also located at the workpiece coordinate system origin, distance L from the reference tool tip position to the base measurement surface is 0. Set, therefore, 0 in the parameter for distance L (No. 5022). The actual measurement surface is usually the same as the base measurement surface, located at the workpiece coordinate system origin. If, however, the measurement surface is the top surface of the reference block, or if the workpiece coordinate system origin is located on other than the top surface of the workpiece (for example, when the origin is shifted from the workpiece top surface by an amount equal to the cutting allowance), set the distance from the base measurement surface to the actual measurement surface as H_m , such that the tool length offset (OFSL) can be calculated using the same formula as that used for definition 1.



The reference tool for definition 2 has a tip at the workpiece coordinate system origin when the machine is positioned to the Z-axis zero point. Whenever the workpiece is changed, therefore, the tool length offset must be remeasured. Remeasuring is not, however, necessary if the difference between the workpiece coordinate system origin for a new workpiece and that when the tool length offset value was measured is set as the new workpiece origin offset (any of G54 to G59). In such a case, the tool length offset need not be modified, even when the workpiece is changed.

Taking a different point of view, definition 2 can be thought of as setting the workpiece origin offset as the tool length offset for each tool.

- **Measuring the tool length offset along a specified axis**

Because the tool is usually mounted in parallel with the Z-axis, the tool length offset is measured by moving the tool along the Z-axis. Some machines, however, have their W-axis in parallel with the Z-axis, making it necessary to measure the tool length offset by moving the tool along the W-axis. Moreover, some machines, when fitted with an attachment, support the mounting of the tool in parallel with an axis other than the Z-axis. For such a machine, the tool length offset can be measured along a specified axis by setting bit 2 (TMA) of parameter No. 5007 to 1. To measure the tool length offset along an axis other than the Z-axis, first set distance L from the reference tool tip position to the base measurement surface, for each of the axes along which the tool length offset may be measured, in parameter No. 5022, in addition to distance L along the Z-axis. Next, set distance Hm from the base measurement surface to the actual measurement surface for the axis along which the tool length offset is to be measured (see Explanations, below). Finally, move the tool along that axis until it touches the workpiece or reference block, then enter the name of that axis before pressing soft key **[MEASURE B]** or **[MEASURE B+]**. When the tool offset is measured along the W-axis, for example, enter W then press soft key **[MEASURE B]** or **[MEASURE B+]**.

- **Tool change position**

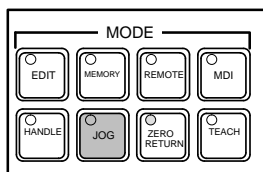
The tool change position must be set beforehand, using bits 1 (TC3) and 0 (TC2) of parameter No. 5007.

TC3	TC2	Meaning
0	0	The tool change position is the first reference position (G28)
0	1	The tool change position is the second reference position (G30 P2)
1	0	The tool change position is the third reference position (G30 P3)
1	1	The tool change position is the fourth reference position (G30 P4)

Procedure for measuring the workpiece origin offset

In addition to the workpiece origin offset along the tool lengthwise axis, that is, the Z-axis, the workpiece origin offsets along the X- and Y-axes, on a plane perpendicular to the Z-axis, can also be measured easily. The workpiece origin offsets along the X- and Y-axes can be measured regardless of whether the workpiece origin is located on a surface of the workpiece or at the center of a hole to be machined. For details of this measurement, refer to the manual supplied by the machine tool builder.

Measuring the Z-axis workpiece origin offset

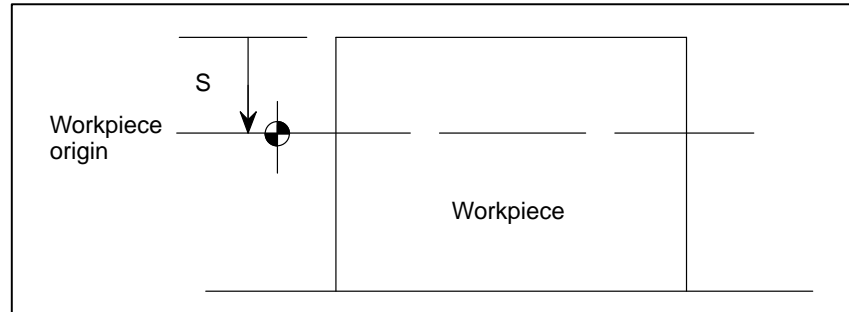


- 1 Select a tool using an MDI command, then move it to the spindle position (see the explanation of the procedure for measuring the tool length offset). The tool length offset for the selected tool must be measured beforehand.
- 2 Press mode selection switch HANDLE or JOG.
- 3 Set the workpiece origin offset measurement mode switch on the machine operator's panel to ON. The workpiece origin offset screen appears and "WOFS" blinks in the status display at the bottom of the screen.
- 4 Enter the tool length offset for the selected tool. Enter the offset using numeric keys then press soft key [TL INPUT].

WORK COORDINATES		01234 N12345	
(G54)			
No.	DATA	NO.	DATA
00	X-12345.678	02	X-12345.678
(EXT)	Y-12345.678	(G55)	Y-12345.678
	Z-12345.678		Z-12345.678
	A-12345.678		A-12345.678
01	X-12345.678	03	X-12345.678
(G54)	Y-12345.678	(G56)	Y-12345.678
	Z-12345.678		Z-12345.678
	A-12345.678		A-12345.678
(MACHINE)	Z-12345.678	(TL)	-12345.678
>			
JOG	**** **	ALM	13:14:15
			WOFS
[OFFSET]	[SETTING]	[WORK]	[(OPRT)]

- 5 Position the cursor to the workpiece origin offset number to be used to store the offset (any of G54 to G59). No problem will arise even if the cursor is positioned to the offset for other than the Z-axis.
- 6 Move the tool by means of manual handle feed or jog feed until it touches the top surface of the workpiece.
- 7 Enter the axis name, Z, press soft key [MEASURE B], then press soft key [INPUT]. The Z-axis workpiece origin offset value is set and the cursor is positioned to the set Z-axis workpiece origin offset. There is no need to enter Z provided the parameter has been set so that only the Z-axis workpiece origin offset is to be measured (bit 3 (WMA) of No. 5007 = 0).

To set the workpiece origin on other than the workpiece top surface (for example, when the origin is shifted from the workpiece top surface by an amount equal to the cutting allowance), enter the amount of shift (S in the following figure) using the numeric keys, press soft key **[MEASURE B]**, then press soft key **[INPUT]**.



- 8 To measure any subsequent workpiece origins, retract the tool from the workpiece, then repeat steps 5 to 7.

Measuring the X-/Y-axis workpiece origin offset based on a reference surface

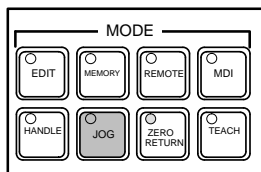
To set the X- or Y-axis workpiece origin offset on a specified surface of the workpiece, set bit 3 (WMA) of parameter No. 5007 to 1, then follow the same procedure as that for measuring the Z-axis workpiece origin offset. In step 4, however, enter the cutter compensation value for the selected tool, instead of the tool length offset. After entering the cutter compensation value with the numeric keys, press soft key **[TL INPUT]**.

NOTE

When entering the cutter compensation value, ensure that its sign is entered correctly.

- When the measurement surface is located in the positive (+) direction relative to the tool, enter a minus (-) sign.
- When the measurement surface is located in the negative (-) direction relative to the tool, enter a plus (+) sign.

Measuring the X-/Y-axis workpiece origin offset based on a reference hole



- 1 Connect a measurement probe, fitted with a sensor, to the spindle.
- 2 Press mode selection switch **HANDLE** or **JOG**.
- 3 Set the workpiece origin offset measurement mode switch on the machine operator's panel to **ON**. The workpiece origin offset screen appears and "WOFS" blinks in the status display at the bottom of the screen, indicating that the preparation required prior to measuring the workpiece origin offset has been completed.
- 4 Position the cursor to the workpiece origin offset number to be used to store the offset (any of G54 to G59). No problem will arise even if the cursor is positioned to the offset for other than the X- or Y-axis.
- 5 Move the tool by means of manual handle feed or jog feed until the measurement probe touches the circumference of the hole. Do not move the tool along more than one axis at any one time.

- 6 As soon as the sensor detects contact with the circumference, input a skip signal to the machine, thus stopping the axial movement of manual handle feed or jog feed. Simultaneously, the position at which feed stopped is stored as the first measurement point. The machine coordinates of the stored measurement point are displayed at the bottom right of the screen, as follows:

WORK COORDINATES		01234 N12345
(G54)		(TL) -12345.678
No.	DATA	(MACHINE)
00	X-12345.678	X-12345.678
(EXT)	Y-12345.678	Y-12345.678
	Z-12345.678	Z-12345.678
	A-12345.678	(HOLE MEASURED)
		#1 X-12345.678
00	X-12345.678	Y-12345.678
(G54)	Y-12345.678	#2 X-12345.678
	Z-12345.678	Y-12345.678
	A-12345.678	#3 X-12345.678
		Y-12345.678
>		
JOG	**** **	ALM 13:14:15 WOFS
[OFFSET]	[SETTING]	[WORK] [(OPRT)]

- 7 Move the measurement probe to the second measurement point. At this time, the CNC interlocks the machine to prevent the probe from moving in the direction in which it was moved so as to touch the current measurement point. For example, when the probe touched the measurement point after being moved in the +X direction, movement of the probe to the next measurement point is allowed only in the -X direction. Movement in the +X, +Y, or -Y direction is interlocked until the skip signal is set to 0. Once the probe touches the second measurement point, follow the same procedure as that for storing the first measurement point.
- 8 Once the probe has touched the third measurement point, press soft key [MEASURE B], then **[CENTER]**. This calculates the center of the hole from the coordinates of the three measured points, then sets the X- and Y-axis workpiece origin offsets. To cancel and restart measurement at any point, press the key. Pressing the key clears the coordinates of all stored measurement points.

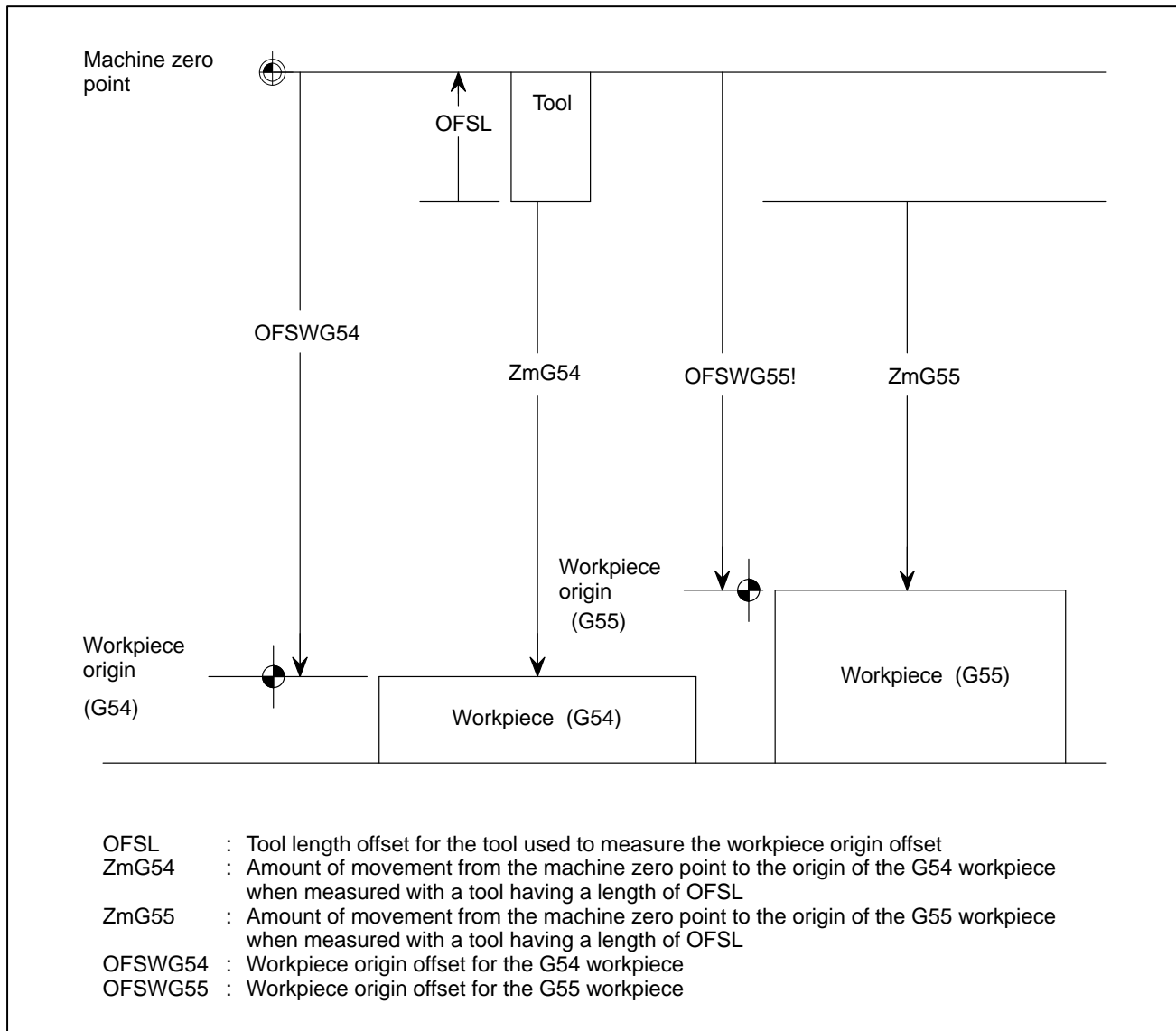
Explanations

- **Z-axis workpiece origin offset**

Definitions 1 and 2, described in "Definition of tool length offset" in Explanations for measuring the tool length offset, also apply to the general concept of the Z-axis workpiece origin offset, as follows:

(1) Definition 1

In definition 1, the Z-axis workpiece origin offset is defined as the distance from the machine zero point to the origin of the workpiece coordinate system.



As can be seen from the above figure, the Z-axis workpiece origin offset can be calculated from the following formula:

$$\text{OFSW} = \text{Zm} - \text{OFSL}$$

where

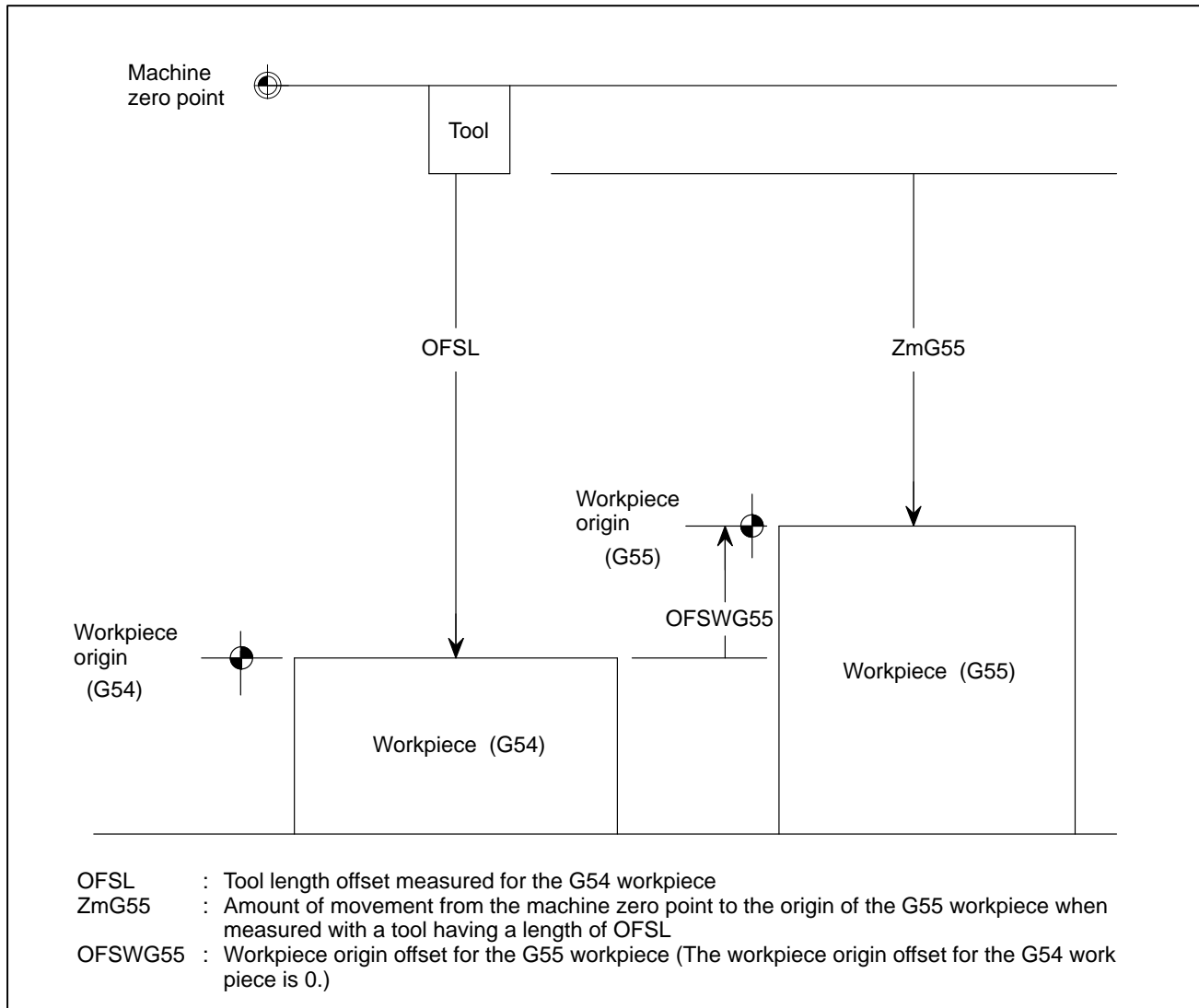
OFSW : Workpiece origin offset

OFSL : Tool length offset for the tool used to measure the workpiece origin offset

Zm : Amount of movement from the machine zero point to the workpiece origin when measured with a tool having a length of OFSL

(2) Definition 2

The tool length offset in definition 2 equals the Z-axis workpiece origin offset, as described above. Usually in this case, therefore, the workpiece origin offset need not be set. If, however, the workpiece is changed after its tool length offset has been measured, or if multiple workpieces are machined, the workpiece origin coordinates can be set as follows when assigning workpiece coordinate systems to G54 to G59, thus eliminating the need to remeasure the tool length offset.



For definition 2, the workpiece origin offset can be calculated using the same formula as that used for definition 1:

$$\text{OFSW} = \text{Zm} - \text{OFSL}$$

where

OFSW : Workpiece origin offset

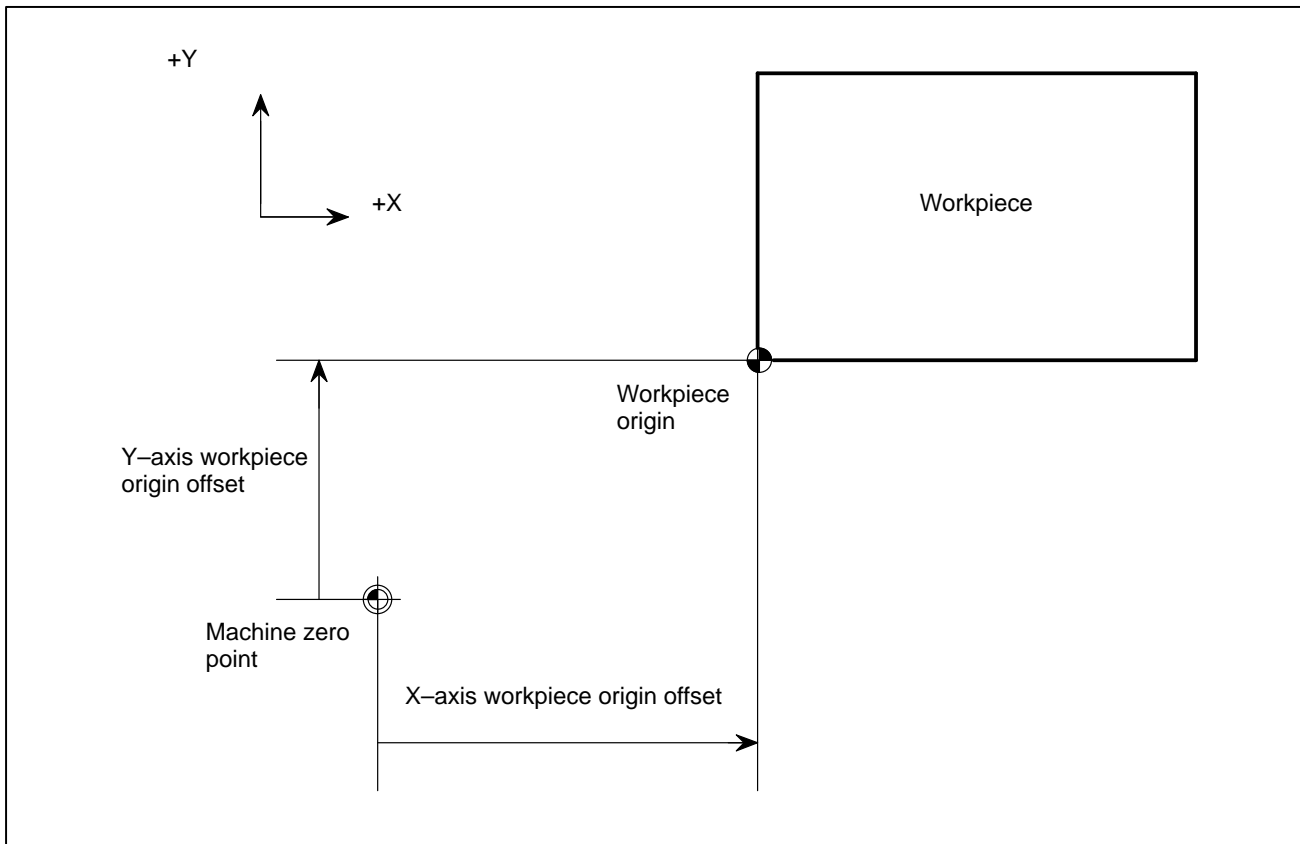
OFSL : Tool length offset for the tool used to measure the workpiece origin offset

Zm : Amount of movement from the machine zero point to the workpiece origin when measured with a tool having a length of OFSL

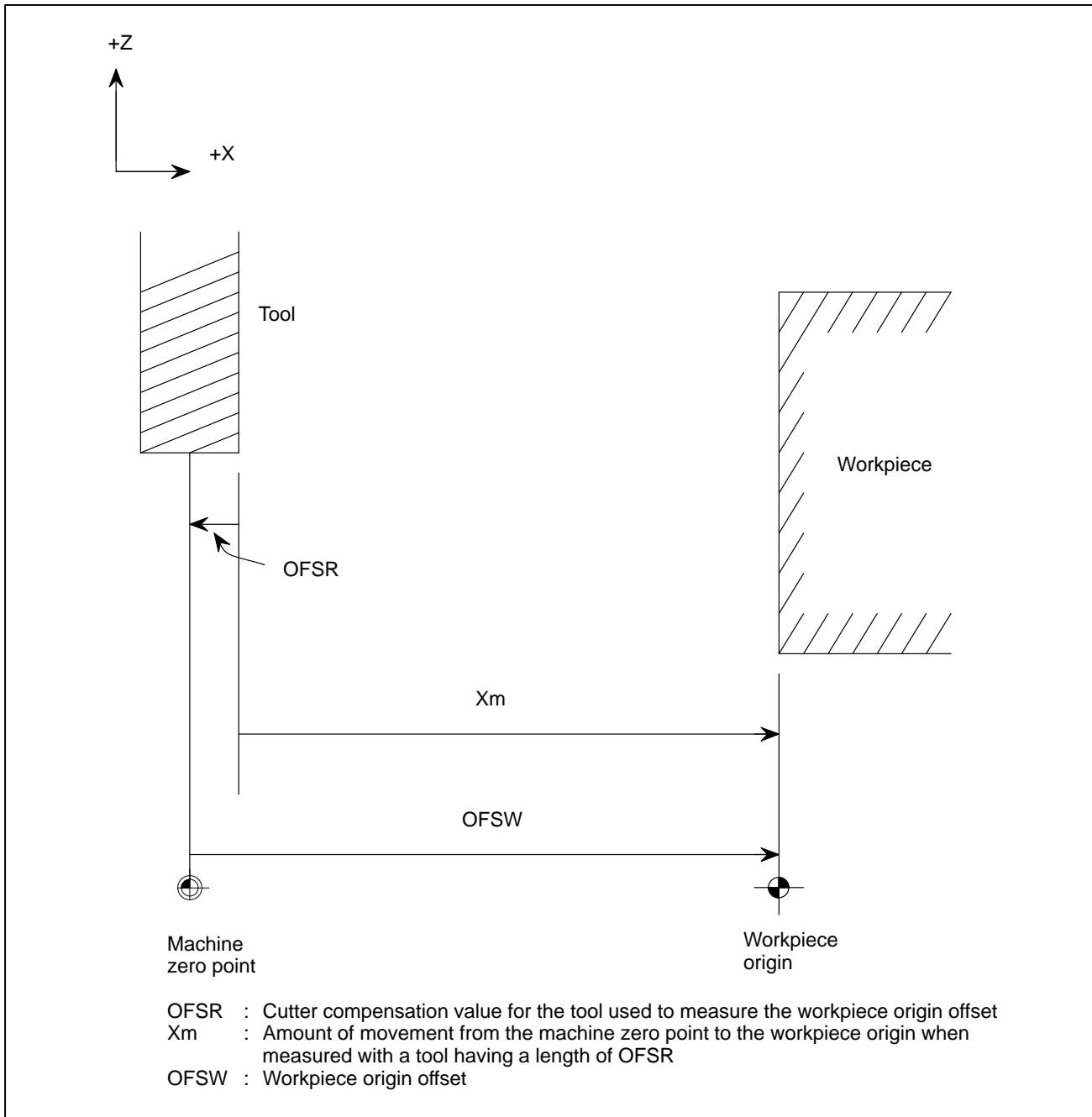
- **X-/Y-axis workpiece origin offset**

The X- and Y-axis workpiece origin offsets can be measured regardless of whether the workpiece origin is located on a surface of the workpiece or at the center of a hole to be machined.

(1) When the workpiece origin is located on a surface



In the above case, the workpiece origin is located on a side surface of the workpiece. The measurement of the X-/Y-axis workpiece origin offset when the origin is located on a surface of the workpiece is the same as that for the Z-axis workpiece origin offset, but with the following exception: The tool length offset for the tool used to measure the offset is used to calculate the Z-axis workpiece origin offset, while the cutter compensation value for the tool is used to calculate the X-/Y-axis workpiece origin offset.



As can be seen from the above figure, the workpiece origin offset can be calculated from the following formula:

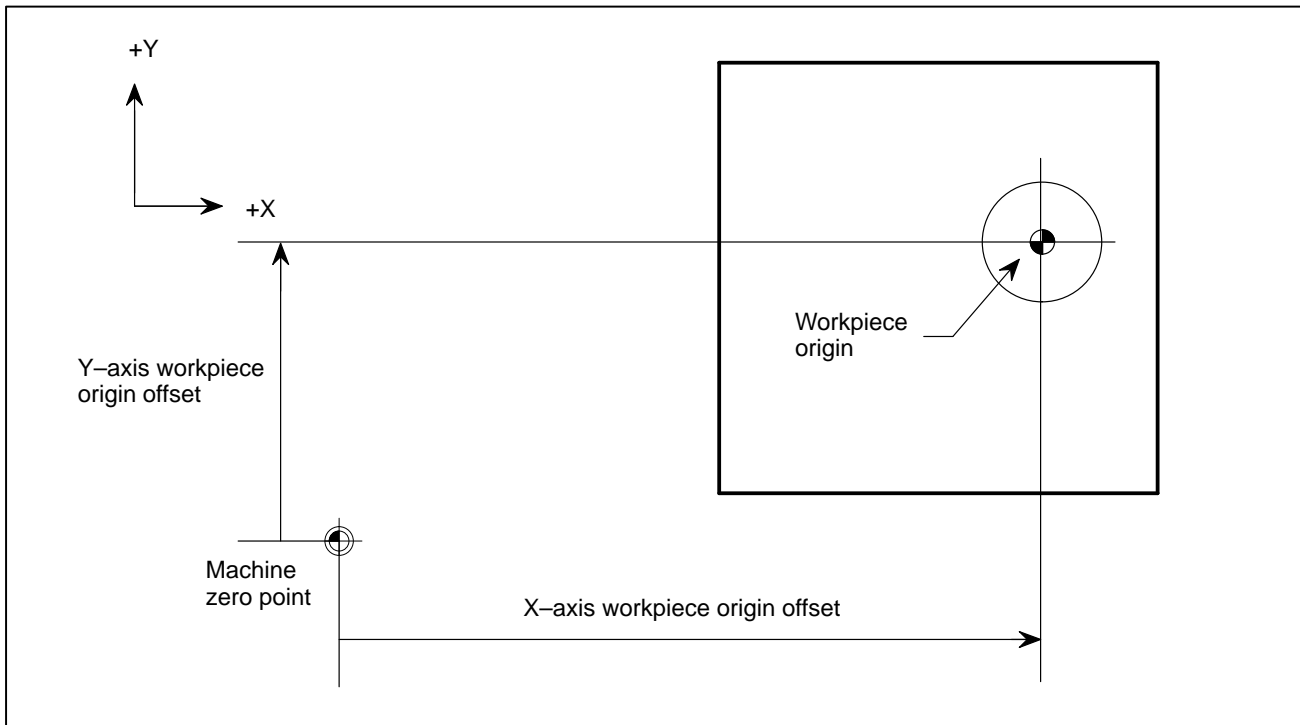
$$\text{OFSW} = \text{Xm} - \text{OFSR}$$

Pay particularly careful attention, however, to the sign of the cutter compensation value OFSR:

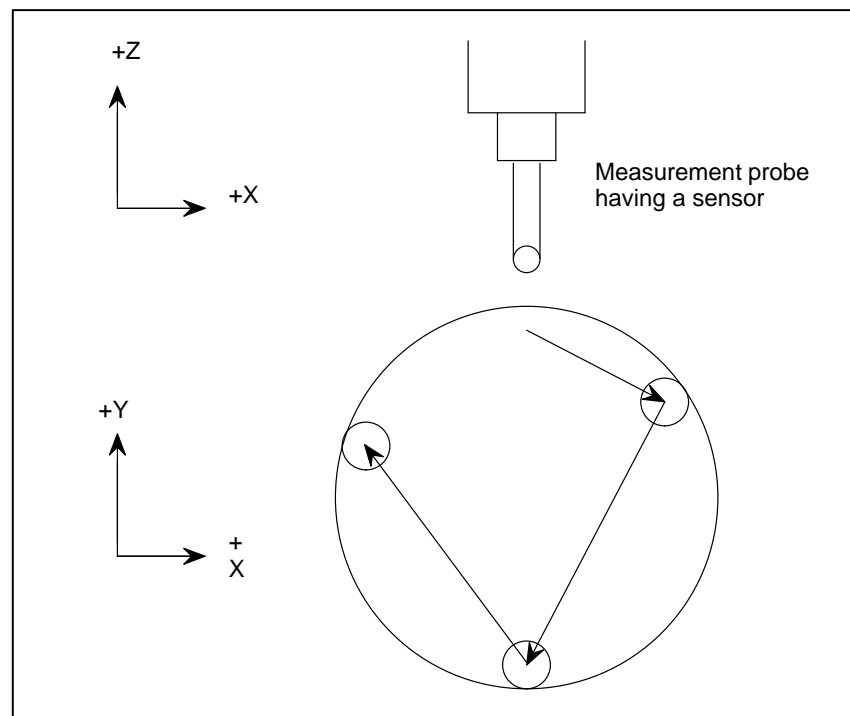
The sign of OFSR is - when the measurement surface is located in the positive (+) direction relative to the tool center.

The sign of OFSR is + when the measurement surface is located in the negative (-) direction relative to the tool center.

(2) When the workpiece origin is located at the center of a hole.



In the above case, the workpiece origin is located at the center of a hole in the workpiece. A measurement probe having a sensor at its tip is used to measure the positions of three arbitrary points on the circumference of the hole. The three points prescribe a unique circle, the center of which is set as the X-/Y-axis workpiece origin. Set bit 4 (WMH) of parameter No. 5007 to 1 before starting the measurement.




- **Using a skip signal**

A measurement probe, fitted with a sensor, can also be used to measure the Z-axis workpiece origin offset or measure the X-/Y-axis workpiece origin offset based on a surface, in the same way as when measuring the X-/Y-axis workpiece origin offset based on a hole. By inputting a skip signal as soon as the probe touches the workpiece surface, feed is automatically stopped. Subsequently, apply the same procedure as that for each measurement.

11.5 SCREENS DISPLAYED BY FUNCTION KEY

When the CNC and machine are connected, parameters must be set to determine the specifications and functions of the machine in order to fully utilize the characteristics of the servo motor or other parts.

This chapter describes how to set parameters on the MDI panel. Parameters can also be set with external input/output devices such as the Handy File (see III-8).

In addition, pitch error compensation data used for improving the precision in positioning with the ball screw on the machine can be set or displayed by the operations under function key  .

See III-7 for the diagnostic screens displayed by pressing function key

 .


11.5.1 Displaying and Setting Parameters

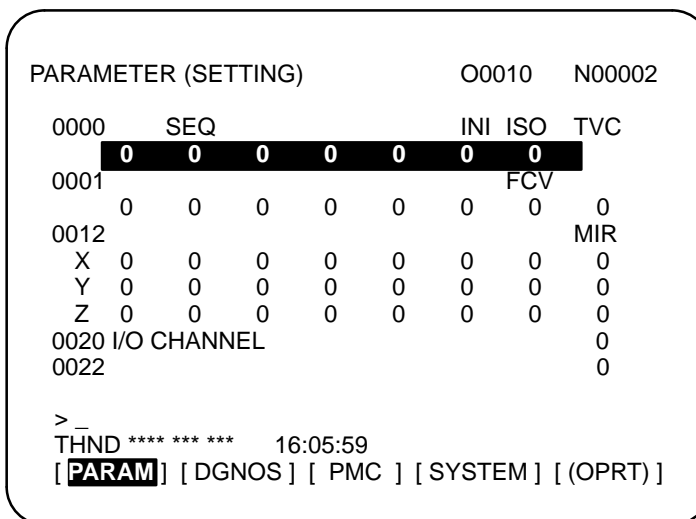
When the CNC and machine are connected, parameters are set to determine the specifications and functions of the machine in order to fully utilize the characteristics of the servo motor. The setting of parameters depends on the machine. Refer to the parameter list prepared by the machine tool builder.







Normally, the user need not change parameter setting.

Procedure for displaying and setting parameters


Procedure

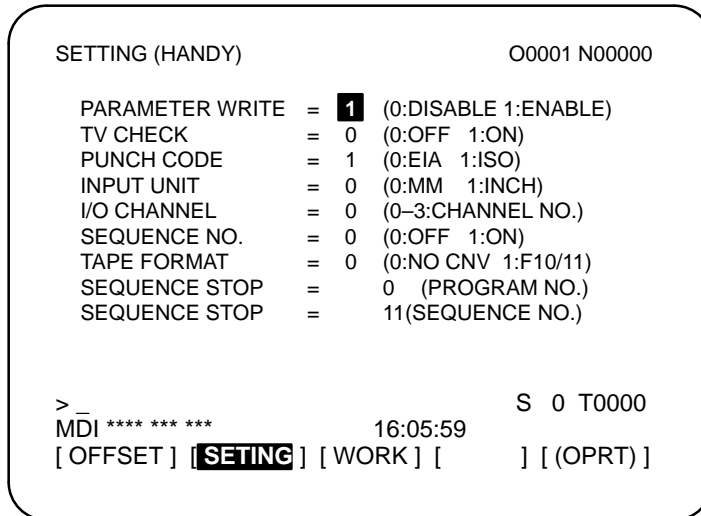
- 1 Set 1 for **PARAMETER WRITE** to enable writing. See the procedure for enabling/disabling parameter writing described below.
- 2 Press function key  .
- 3 Press chapter selection soft key **[PARAM]** to display the parameter screen.




- 4 Move the cursor to the parameter number to be set or displayed in either of the following ways:
 - Enter the parameter number and press soft key **[NO.SRH]** .
 - Move the cursor to the parameter number using the page keys,  and  , and cursor keys,  ,  ,  , and  .
- 5 To set the parameter, enter a new value with numeric keys and press soft key **[INPUT]**. The parameter is set to the entered value and the value is displayed.
- 6 Set 0 for **PARAMETER WRITE** to disable writing.

Procedure for enabling/displaying parameter writing

- 1 Select the **MDI** mode or enter state emergency stop.
- 2 Press function key  .
- 3 Press soft key [**SETTING**] to display the setting screen.



- 4 Move the cursor to **PARAMETER WRITE** using cursor keys.
- 5 Press soft key [(OPRT)], then press **[1: ON]** to enable parameter writing.
At this time, the CNC enters the P/S alarm state (No. 100).
- 6 After setting parameters, return to the setting screen. Move the cursor to **PARAMETER WRITE** and press soft key [(OPRT)] , then press **[0: OFF]**.
- 7 Depress the  key to release the alarm condition. If P/S alarm No. 000 has occurred, however, turn off the power supply and then turn it on, otherwise the P/S alarm is not released.

Explanations

- **Setting parameters with external input/output devices**
- **Parameters that require turning off the power**
- **Parameter list**
- **Setting data**

See III-8 for setting parameters with external input/output devices such as the Handy File.

Some parameters are not effective until the power is turned off and on again after they are set. Setting such parameters causes P/S alarm 000. In this case, turn off the power, then turn it on again.

Refer to the FANUC Series 16i/18i/160i/180i-A Parameter Manual (B-63010EN) for the parameter list.

Some parameters can be set on the setting screen if the parameter list indicates "Setting entry is acceptable". Setting 1 for **PARAMETER WRITE** is not necessary when three parameters are set on the setting screen.

11.5.2 Displaying and Setting Pitch Error Compensation Data

If pitch error compensation data is specified, pitch errors of each axis can be compensated in detection unit per axis.

Pitch error compensation data is set for each compensation point at the intervals specified for each axis. The origin of compensation is the reference position to which the tool is returned.

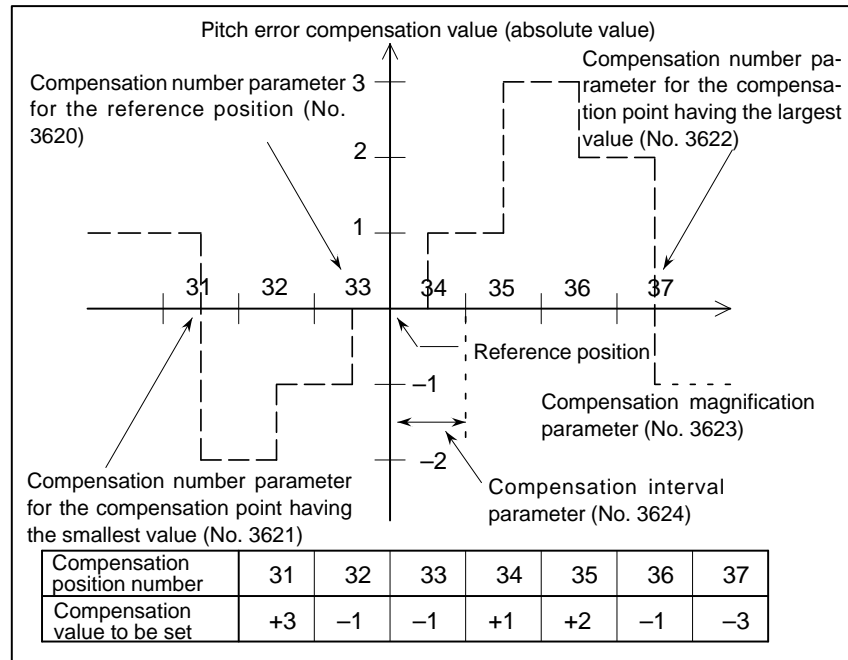
The pitch error compensation data is set according to the characteristics of the machine connected to the NC. The content of this data varies according to the machine model. If it is changed, the machine accuracy is reduced.

In principle, the end user must not alter this data.

Pitch error compensation data can be set with external devices such as the Handy File (see III-8). Compensation data can also be written directly with the MDI panel.

The following parameters must be set for pitch error compensation. Set the pitch error compensation value for each pitch error compensation point number set by these parameters.

In the following example, 33 is set for the pitch error compensation point at the reference position.




- Number of the pitch error compensation point at the reference position (for each axis) : Parameter 3620
- Number of the pitch error compensation point having the smallest value (for each axis) : Parameter 3621
- Number of the pitch error compensation point having the largest value (for each axis) : Parameter 3622
- Pitch error compensation magnification (for each axis) : Parameter 3623
- Interval of the pitch error compensation points (for each axis) : Parameter 3624

Procedure for displaying and setting the pitch error compensation data

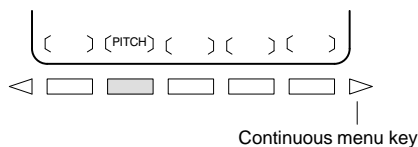
Procedure

- Set the following parameters:
 - Number of the pitch error compensation point at the reference position (for each axis): Parameter 3620
 - Number of the pitch error compensation point having the smallest value (for each axis): Parameter 3621
 - Number of the pitch error compensation point having the largest value (for each axis): Parameter 3622
 - Pitch error compensation magnification (for each axis): Parameter 3623
 - Interval of the pitch error compensation points (for each axis): Parameter 3624

- Press function key .







- Press the continuous menu key , then press chapter selection soft key **[PITCH]**.

The following screen is displayed:



PIT-ERROR SETTING				O0000 N00000	
NO.	DATA	NO.	DATA	NO.	DATA
0000	0	0010	0	0020	0
0001	0	0011	0	0021	0
0002	0	0012	0	0022	0
0003	0	0013	0	0023	0
(X) 0004	0	0014	0	0024	0
0005	0	0015	0	0025	0
0006	0	0016	0	0026	0
0007	0	0017	0	0027	0
0008	0	0018	0	0028	0
0009	0	0019	0	0029	0
>_					
MEM **** * * *				16:05:59	
[NO.SRH] [ON:1] [OFF:0] [+INPUT] [-INPUT]					

- Move the cursor to the compensation point number to be set in either of the following ways:

- Enter the compensation point number and press the **[NO.SRH]** soft key.
- Move the cursor to the compensation point number using the page keys,  and , and cursor keys, , , , and .

- Enter a value with numeric keys and press the **[INPUT]** soft key.

11.6 DISPLAYING THE PROGRAM NUMBER, SEQUENCE NUMBER, AND STATUS, AND WARNING MESSAGES FOR DATA SETTING OR INPUT/OUTPUT OPERATION

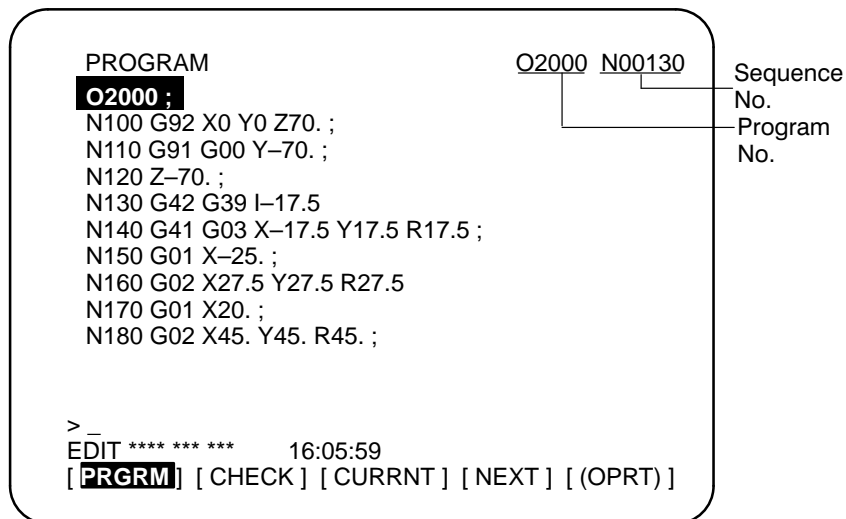
The program number, sequence number, and current CNC status are always displayed on the screen except when the power is turned on, a system alarm occurs, or the PMC screen is displayed.

If data setting or the input/output operation is incorrect, the CNC does not accept the operation and displays a warning message.

This section describes the display of the program number, sequence number, and status, and warning messages displayed for incorrect data setting or input/output operation.

11.6.1 Displaying the Program Number and Sequence Number

The program number and sequence number are displayed at the top right on the screen as shown below.



The program number and sequence number displayed depend on the screen and are given below:

On the program screen in the EDIT mode on Background edit screen :
The program No. being edited and the sequence number just prior to the cursor are indicated.

Other than above screens :

The program No. and the sequence No. executed last are indicated.

Immediately after program number search or sequence number search :

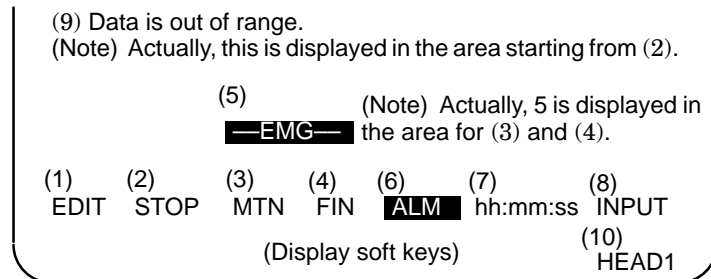
Immediately after the program No. search and sequence No. search, the program No. and the sequence No. searched are indicated.

11.6.2 Displaying the Status and Warning for Data Setting or Input/Output Operation

The current mode, automatic operation state, alarm state, and program editing state are displayed on the next to last line on the screen allowing the operator to readily understand the operation condition of the system. If data setting or the input/output operation is incorrect, the CNC does not accept the operation and a warning message is displayed on the next to last line of the screen. This prevents invalid data setting and input/output errors.

Explanations

Description of each display



NOTE

Actually, (10) is displayed at the position where (8) is now displayed.

(1) Current mode

MDI : Manual data input, MDI operation
MEM : Automatic operation (memory operation)
RMT : Automatic operation (DNC operation, or such like)
EDIT : Memory editing
HND : Manual handle feed
JOG : Jog feed
TJOG : TEACH IN JOG
THND : TEACH IN HANDLE
INC : Manual incremental feed
REF : Manual reference position return

(2) Automatic operation status

**** : Reset (When the power is turned on or the state in which program execution has terminated and automatic operation has terminated.)
STOP : Automatic operation stop (The state in which one block has been executed and automatic operation is stopped.)
HOLD : Feed hold (The state in which execution of one block has been interrupted and automatic operation is stopped.)
STRT : Automatic operation start-up (The state in which the system operates automatically)

(3) Axis moving status/dwell status

MTN : Indicates that the axis is moving.
DWL : Indicates the dwell state.
*** : Indicates a state other than the above.

(4) State in which an auxiliary function is being executed

FIN : Indicates the state in which an auxiliary function is being executed. (Waiting for the complete signal from the PMC)
*** : Indicates a state other than the above.


- (5) Emergency stop or reset status** **—EMG—** : : Indicates emergency stop.(Blinks in reversed display.)
—RESET— : : Indicates that the reset signal is being received.
- (6) Alarm status** **ALM** : : Indicates that an alarm is issued. (Blinks in reversed display.)
BAT : : Indicates that the battery is low. (Blinks in reversed display.)
Space : : Indicates a state other than the above.
- (7) Current time** hh:mm:ss – Hours, minutes, and seconds
- (8) Program editing status** INPUT : : Indicates that data is being input.
OUTPUT : : Indicates that data is being output.
SRCH : : Indicates that a search is being performed.
EDIT : : Indicates that another editing operation is being performed
(insertion, modification, etc.)
LSK : : Indicates that labels are skipped when data is input.
RSTR : : Indicates that the program is being restarted
Space : : Indicates that no editing operation is being performed.
- (9) Warning for data setting or input/output operation** When invalid data is entered (wrong format, value out of range, etc.), when input is disabled (wrong mode, write disabled, etc.), or when input/output operation is incorrect (wrong mode, etc.), a warning message is displayed. In this case, the CNC does not accept the setting or input/output operation (retry the operation according to the message). The following are examples of warning messages:
- Example 1)**
When a parameter is entered
- ```
> 1
EDIT WRONG MODE

(Display soft keys)
```
- Example 2)**  
When a parameter is entered
- ```
> 999999999
MDI  TOO MANY DIGITS

(Display soft keys)
```
- Example 3)**
When a parameter is output to an external input/output device
- ```
> _
MEM WRONG MODE

(Display soft keys)
```
- (10) Tool post name (for the two-path control)**      HEAD1 : : Tool post 1 is selected.  
HEAD2 : : Tool post 2 is selected.  
Other names can be used depending on the settings of parameters 3141 to 3147.  
The tool post name is displayed at the position where (8) is now displayed. While the program is edited, (8) is displayed.

# 11.7 SCREENS DISPLAYED BY FUNCTION KEY



By pressing the function key  , data such as alarms, alarm history data, and external messages can be displayed. For information relating to alarm display, see Section III.7.1. For information relating to alarm history display, see Section III.7.2. For information relating to external message display, see the relevant manual supplied by the machine tool builder.

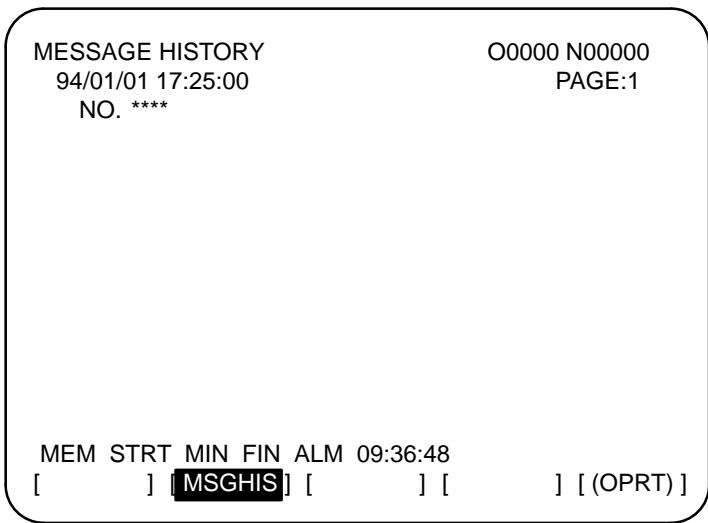
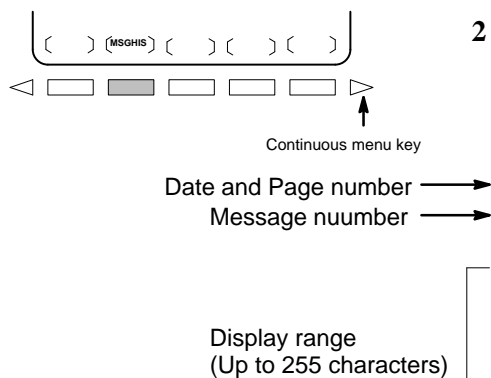
## 11.7.1 External Operator Message History Display

External operator messages can be preserved as history data. Preserved history data can be displayed on the external operator message history screen.

### Procedure for external operator message history display

#### Procedure

- 1 Press the  function key.
- 2 Press the continuous menu key  , then press the chapter selection soft key **[MSGHIS]**. The screen shown below appears.



**NOTE**  
Up to 255 characters can be specified for an external operator message. By setting MS1 and MS0 (bits 7 and 6 of parameter No. 3113), however, the number of characters that can be preserved as external operator message history data can be restricted, and the number of history data items selected.

## Explanations

- **Updating external operator message history data**

When an external operator message number is specified, updating of the external operator message history data is started; this updating is continued until a new external operator message number is specified or deletion of the external operator message history data is specified.
- **Clearing external operator message history data**

To clear external operator message history data, press the **[CLEAR]** soft key. This clears all external operator message history data. (Set MSGCR (bit 0 of parameter No. 3113) to 1.)  
Note that when MS1 and MS0 (bits 7 and 6 of parameter No. 3113), used to specify the number of external operator message history data items to be displayed, are changed, all existing external operator message history data is cleared.

## Limitations

- **Two-path control**

When two-path control is exercised, the external operator messages for system 1 are displayed. (The external operator messages for system 2 are not displayed.)
- **Option**


Before this function can be used, the external data input function or optional external message function must be selected.

## 11.8 CLEARING THE SCREEN

Displaying the same characters in the same positions on the screen causes a LCD to degrade relatively quickly. To help prevent this, the screen can be cleared by pressing specific keys. It is also possible to specify the automatic clearing of the screen if no keys are pressed during a period specified with a parameter.

---

### 11.8.1 Erase Screen Display

Holding down the  key and pressing an arbitrary function key clears the screen.




---

#### Procedure for erase screen display

---

#### Procedure

- **Clearing the screen**

Hold down the  key and press an arbitrary function key (such as  and  ).

- **Restoring the screen**

Press an arbitrary function key.

## 11.8.2 Automatic Erase Screen Display

The CNC screen is automatically cleared if no keys are pressed during the period (in minutes) specified with a parameter. The screen is restored by pressing any key.

### Procedure for automatic erase screen display

- **Clearing the screen**

The CNC screen is cleared once the period (minutes) specified with parameter No. 3123 has elapsed, provided the following conditions are satisfied:

#### Conditions for clearing the CNC screen

- Parameter No. 3123 is set to other than 0.
- None of the following keys have been pressed:
  - MDI keys
  - Soft keys
  - External input keys
- No alarm has been issued.

- **Restoring the screen**

The cleared CNC screen is restored once at least one of the following conditions is satisfied:


#### Conditions for restoring the CNC screen


- Any of the following keys has been pressed:
  - MDI keys
  - Soft keys
  - Externally input keys
- An alarm has been issued.

Some machines feature a special key for restoring the screen. For an explanation of the location and use of this key, refer to the corresponding manual, supplied by the machine tool builder.

### Explanations

- **Clearing the screen**

using  + function key

If parameter No. 3123 is set to 0, clearing of the screen using the  key and a function key (III-11.8.1) is disabled.




- **Specified period**

The period specified with parameter No. 3123 is valid only for tool post 1.

- **Alarm for another path**

The screen is not cleared if an alarm is issued for tool post 1 or 2 or the loader before the specified period elapses.

#### CAUTION

Pressing any key while the screen is being cleared restores the screen. In such a case, however, the function assigned to the pressed key is initiated. Do not press the , , or  key to restore the screen, therefore.



# 12

## GRAPHICS FUNCTION

---

Two graphic functions are available. One is a graphic display function, and the other is a dynamic graphic display function.

The graphic display function can draw the tool path specified by a program being executed on a screen. The graphic display function also allows enlargement and reduction of the display.

The dynamic graphic display function can draw a tool path and machining profile.

In tool path drawing, automatic scaling and solid drawing are possible. In machining profile drawing, the status of machining in progress can be drawn through simulation. Blank figures can also be drawn.

The background drawing function enables drawing to be performed by one program while machining is performed by another program.

This chapter mainly explains drawing procedures and drawing parameters for the following:

1. Drawing the tool path specified by a program being executed, with the graphic display function
2. Drawing the tool path with the dynamic graphic display function
3. Drawing the machining profile with the dynamic graphic display function
4. Background drawing procedure

## 12.1 GRAPHICS DISPLAY

It is possible to draw the programmed tool path on the screen, which makes it possible to check the progress of machining, while observing the path on the screen.

In addition, it is also possible to enlarge/reduce the screen.

Before drawing, graphic parameters must be set.

When the dynamic graphics function is used, the graphics function described in this section cannot be used. See Section 12.2 for the dynamic graphics function.


### Graphics display procedure

#### Procedure

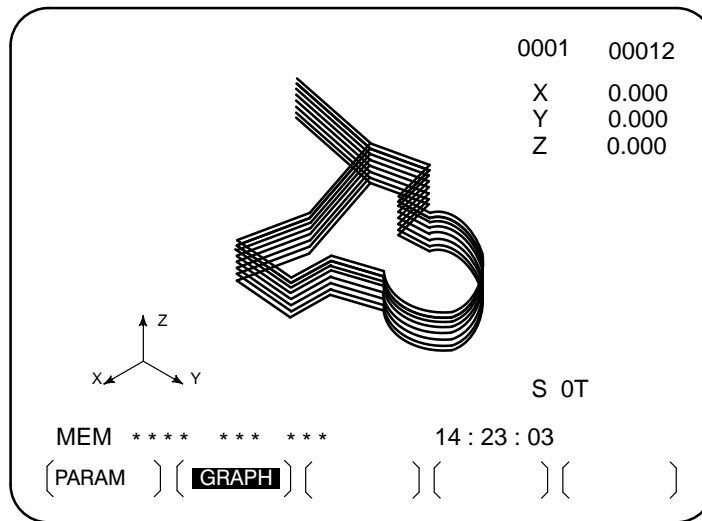
- 1 Press function key . Press  for a small MDI unit.

The graphic parameter screen shown below appears. (If this screen does not appear, press soft key **[PARAM]**.)

| GRAPHIC PARAMETER |                                        | O0000 N00000 |        |
|-------------------|----------------------------------------|--------------|--------|
| AXES              | P= <b>4</b>                            |              |        |
|                   | (XY=0, YZ=1, ZY=2, XZ=3, XYZ=4, ZXY=5) |              |        |
| RANGE (MAX.)      |                                        |              |        |
| X=                | 115000                                 | Y=           | 150000 |
| Z=                |                                        |              | 0      |
| RANGE (MIN.)      |                                        |              |        |
| X=                | 0                                      | Y=           | 0      |
| Z=                |                                        |              | 0      |
| SCALE             |                                        | K=           | 70     |
| GRAPHIC CENTER    |                                        |              |        |
| X=                | 57500                                  | Y=           | 75000  |
| Z=                |                                        |              | 0      |
| PROGRAM STOP      | N=                                     |              | 0      |
| AUTO ERASE        | A=                                     |              | 1      |
| MDI *****         |                                        | 14:23:54     |        |
| <b>[PARAM]</b>    | }[GRAPH]                               | {            | }{ }   |

- 2 Move the cursor with the cursor keys to a parameter to set.
- 3 Enter data, then press the  key.
- 4 Repeat steps 2 and 3 until all required parameters are specified.
- 5 Press soft key **[GRAPH]**.

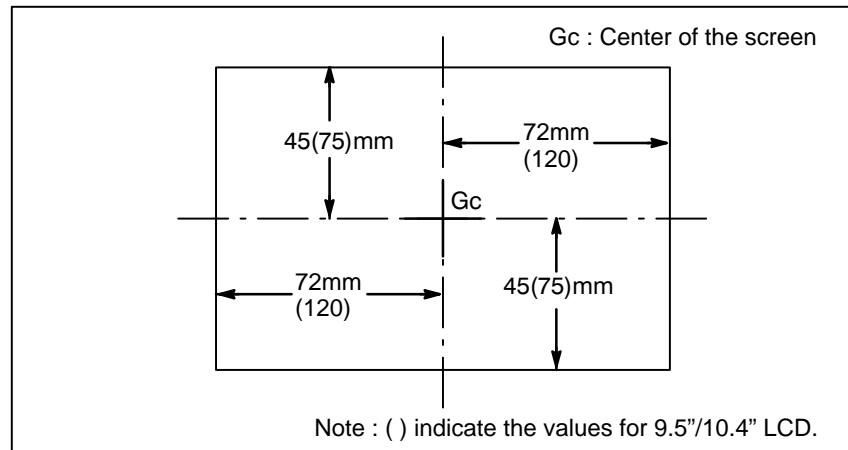
- 6 Automatic operation is started and machine movement is drawn on the screen.



**Explanation**

- **RANGE (Actual graphic range)**

The size of the graphic screen will be as follows:



**Fig.12.1 (a) Graphic range**

As shown in Fig.12.1 (a), the maximum graphics range is an area of approx. 144 mm (width) × 90 mm (height) for 7.2"/8.4" LCD and approx. 240 mm (width) × 150 mm (height) for 9.5"/10.4" LCD.

- **Setting the graphics range**

To draw a section of the program within the actual graphics range, set the graphics range using one of the following two methods:

- 1 . Set the center coordinates of the range and the magnification.
- 2 . Set the maximum and minimum coordinates for the range in the program.

Whether 1 or 2 is used depends on which parameters are set last. A graphics range which has been set is retained when the power is turned off.

1. Setting the center coordinate of the graphics range and graphics magnification

Set the center of the graphic range to the center of the screen. If the drawing range in the program can be contained in the above actual graphics range, set the magnification to 1 (actual value set is 100).

When the drawing range is larger than the maximum graphics range or much smaller than the maximum graphics range, the graphics magnification should be changed. The graphics magnification is 0.01 to 100.00 times, which is usually determined as follows;

Graphics magnification=Graphics magnification (**H**), or graphics magnifications (**V**), whichever is smaller

Graphics magnification **H** = $\alpha$ /(length on program to horizontal direction axis)

Graphics magnification **V** = $\beta$ /(length on program to vertical direction axis)

$\alpha$ :144mm(for 7.2"/8.4" LCD)

$\beta$ :90mm

$\alpha$ :240mm(for 9.5"/10.4" LCD)

$\beta$ :150mm

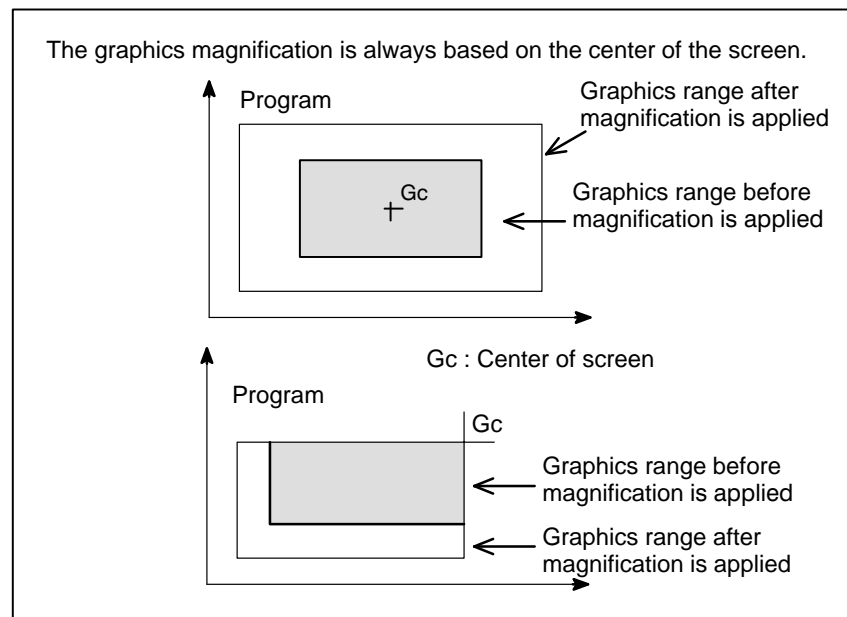


Fig.12.1 (b) Applying graphics magnification (Example of enlargement)

2. Setting the maximum and minimum coordinates for the drawing range in the program

When the actual tool path is not near the center of the screen, method 1 will cause the tool path to be drawn out of the graphics range if graphics magnification is not set properly.

To avoid such cases, the following six graphic parameters are prepared;

**Graphic range (Max.) X**

**Graphic range (Max.) Y**

**Graphic range (Max.) Z**

**Graphic range (Min.) X**

**Graphic range (Min.) Y**

**Graphic range (Min.) Z**

With the above parameters, the center of screen (Gcx, Gcy, Gcz) is determined by the CNC as follows;

$$Gcx = (X (MAX.) + X (MIN.) ) / 2$$

$$Gcy = (Y (MAX.) + Y (MIN.) ) / 2$$

$$Gcz = (Z (MAX.) + Z (MIN.) ) / 2$$

The unit of the value will be 0.001 mm or 0.0001 inch depending on the input unit.

Graphics magnification is applied automatically. When the graphics range is specified, the center coordinates and magnification do not need to be calculated.

- **Work coordinate system and graphics**

The graphic origin and graphic center point will not be changed even if the workpiece coordinate origin is changed.

In other words, the workpiece coordinate origin is always consistent with the graphic origin.

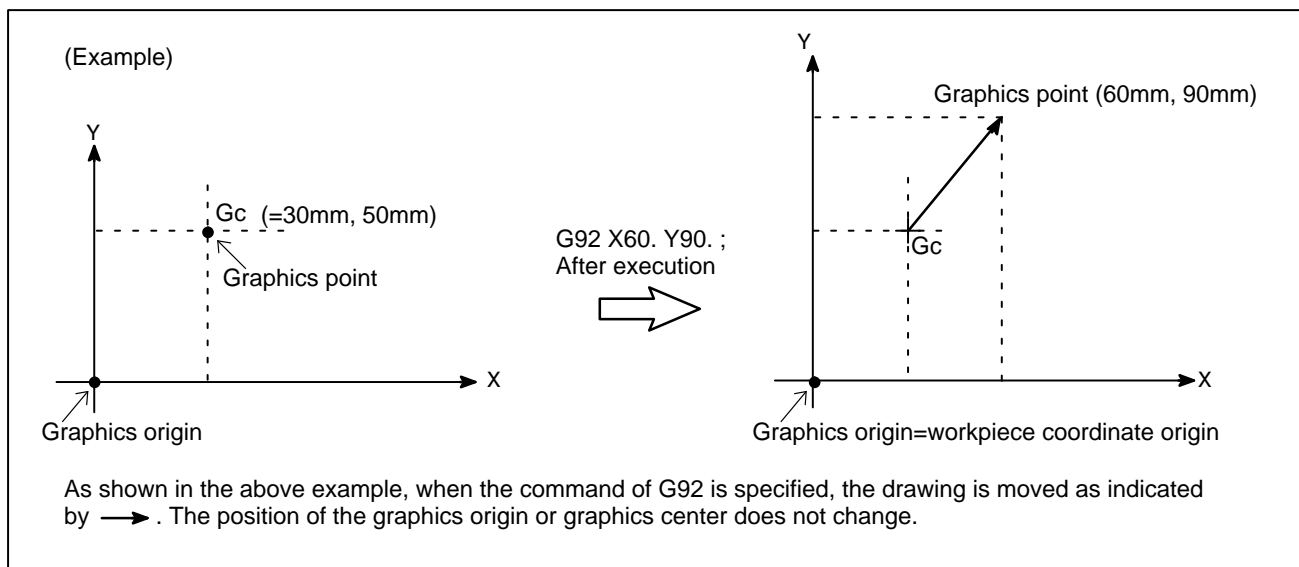


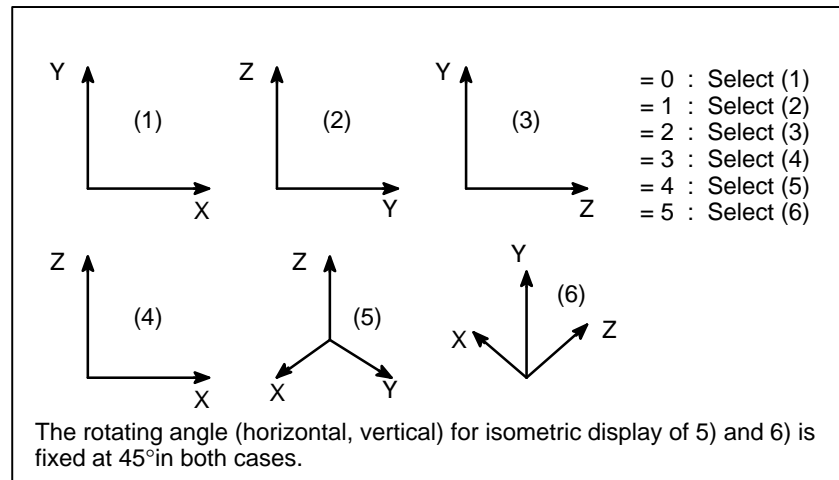
Fig.12.1 (c) Workpiece coordinate origin and graphics origin

- **Graphics parameter**

- **AXES**

Specify the plane to use for drawing. The user can choose from the following six coordinate systems.

With two-path control, a different drawing coordinate system can be selected for each tool post.



**Fig12.1 (d) Coordinate system**

- **RANGE (Max., Min.)**

Set the graphic range displayed on the screen by specifying maximum and minimum values along each axis.

X=Maximum value X=Minimum value

Y=Maximum value Y=Minimum value

Z=Maximum value Z=Minimum value

Valid range: 0 to  $\pm 9999999$

**NOTE**

- 1 The units are 0.001 mm or 0.0001 inch. Note that the maximum value must be greater than the minimum value for each axis.
- 2 When setting the graphics range with the graphics parameters for the maximum and minimum values, do not set the parameters for the magnification and screen center coordinates afterwards. Only the parameters set last are effective.

- **SCALE**

Set the graphic magnification

The setting range is 0 to 10000 (unit:0.01 time).

· **GRAPHIC CENTER**

X= \_

Y= \_

Z= \_

Set the coordinate value on the workpiece coordinate system at graphic center.

**NOTE**

- 1 When MAX. and MIN. of RANGE are set, the values will be set automatically once drawing is executed
- 2 When setting the graphics range with the graphics parameters for the magnification and screen center coordinates, do not set the parameters for the maximum and minimum values afterward. Only the parameters set last are effective.

· **PROGRAM STOP**

N= \_

Set the sequence No. of the end block when necessary to partially display.

This value is automatically cancelled and set to -1 once drawing is executed.

· **AUTO ERASE**

1 : Erase the previous drawing automatically when the automatic operation is started under reset condition.

2 : Not erase automatically.

● **Executing drawing only**

Since the graphic drawing is done when coordinate value is renewed during automatic operation, etc., it is necessary to start the program by automatic operation. To execute drawing without moving the machine, therefore, enter the machine lock state.

● **Deleting the previous drawing**

When the AUTO operation is started under reset condition, the program is executed after deleting the previous drawing automatically (Automatic deleting=1). It is possible not to delete the previous drawing by graphic parameter (Automatic deleting=0).

● **Drawing a part of a program**

When necessary to display a part of a program, search the starting block to be drawn by the sequence No. search, and set the sequence No. of the end block to the PROGRAM STOP N= of the graphic parameter before starting the program under cycle operation mode.

● **Drawing using dashed lines and solid lines**

The tool path is shown with a dashed line (- - - -) for rapid traverse and with a solid line (—) for cutting feed.

**Limitations**

● **Feedrate**

In case the feed rate is considerably high, drawing may not be executed correctly, decrease the speed by dry-run, etc. to execute drawing.

● **Two-path lathe control**

For the two-path lathe control, two paths can not be displayed at the same time.

## 12.2 DYNAMIC GRAPHIC DISPLAY

There are the following two functions in Dynamic Graphics.

|               |                                                                                                    |
|---------------|----------------------------------------------------------------------------------------------------|
| Path graphic  | This is used to draw the path of tool center commanded by the part program.                        |
| Solid graphic | This is used to draw the workpiece figure machined by tool movement commanded by the part program. |

The path graphic function is used to precisely check the part program for drawing the tool path with a line. The solid graphic function is used to draw the workpiece figure to be machined with a program. Thus, it is easy to recognize roughly the part program. These two functions can be used freely by switching them.

### 12.2.1 Path Drawing

The path graphic feature calls a program from memory and draws the tool path specified by the program. This feature provides the following functions.

1. Drawing plane  
The user can choose the drawing plane from four types of plane views, two types of isometric projection views, and biplane view.
2. Drawing rotation  
When an isometric projection view is used, the drawing can be rotated horizontally and vertically.
3. Drawing enlargement and reduction  
A drawing can be enlarged or reduced by specifying a magnification from 0.01 to 100 with respect to the actual size. In addition, a drawing can be automatically enlarged or reduced by setting maximum and minimum values.
4. Partial drawing  
A range of the program can be drawn by specifying a starting sequence number and ending sequence number.
5. Programmed path and tool path drawing  
The user can specify whether to apply tool length offset and cutter compensation to drawing. This way, either the actual programmed path or the tool path can be drawn.
6. Color  
When a tool path is drawn on a screen, the colors used can be chosen from seven colors including white. The color of the tool path can be changed according to the T code.
7. Automatic scaling  
The CNC automatically determines the maximum and minimum drawing coordinates for each program. This means that drawing can be performed with a magnification automatically determined according to these maximum and minimum values.
8. Partial enlargement drawing  
Except for biplane views the user can enlarge all types of drawings by a factor of up to 100 while looking at the drawing that has been made.
9. Indicating the current tool position with a mark  
The current tool position can be displayed on the screen.
10. Indicating the coordinates of the current position  
The current position can also be indicated using coordinates.



11. Displaying coordinate axes and actual size dimensions lines

Coordinate axes and actual size dimension lines are displayed together with the drawing so that actual size can be referenced.

The first six functions above (1. to 6.) are available by setting the graphic parameters. The seventh to ninth functions (7. to 9.) are mainly executed using soft keys after drawing has been setup. The tenth function (10.) is enabled by setting a parameter. The eleventh function (11.) can be used at any time.

**Path drawing procedure**

**Procedure**

- To draw a tool path, necessary data must be set beforehand. So press the function button **GRAPH** some times ( **CUSTOM GRAPH** for the small MDI).The “PATH GRAPHIC (PARAMETER)” is displayed.

```

PATH GRAPHIC (PARAMETER-1) O0000 N00002

AXES P= 4
(XY=0, YZ=1, ZY=2, XZ=3, XYZ=4, ZXY=5, 2P=6)
ANGLE
ROTATION A= 0
TILTING A= 0
SCALE K= 0.00
CENTER OR MAX./MIN.
 X=130.000 Y= 110.000 Z= 50.000
 I= 0.000 J= -10.000 K= 0.000
START SEQ. NO. N= 0
END SEQ. NO. N= 0
NO. A=

MDI ***** 14:25:07

{ PARAM } { EXEC } { SCALE } { POS }

```

```

PATH GRAPHIC (PARAMETER-2) O0000 N00001

TOOL. COMP P= 0
COLOR (0123456)
PATH P= 0
TOOL Q= 0
AUTO CHANGE R= 0

MDI ***** 14:25:51

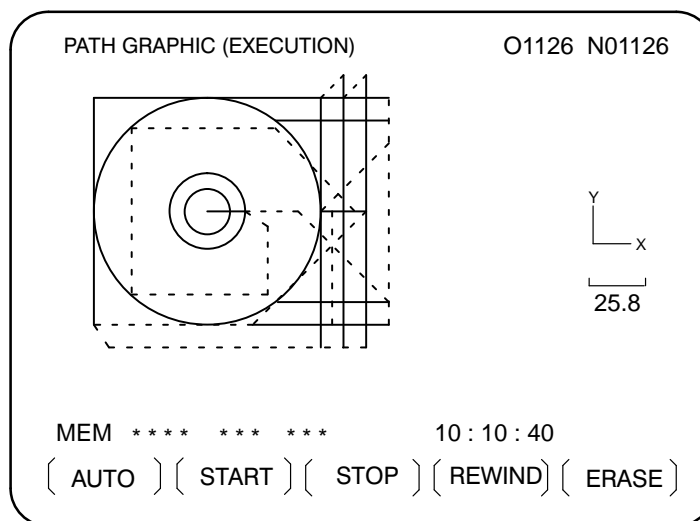
{ PARAM } { EXEC } { SCALE } { POS }

```

- 2 There are two screens for setting drawing parameters.  
Press the page key according to the setting items for selecting screens.
- 3 Set the cursor to an item to be set by cursor keys.
- 4 Input numerics by numeric keys.
- 5 Press the  key.

The input numerics are set by these operations and the cursor automatically moves to the next setting items. The set data is held even after the power is turned off.

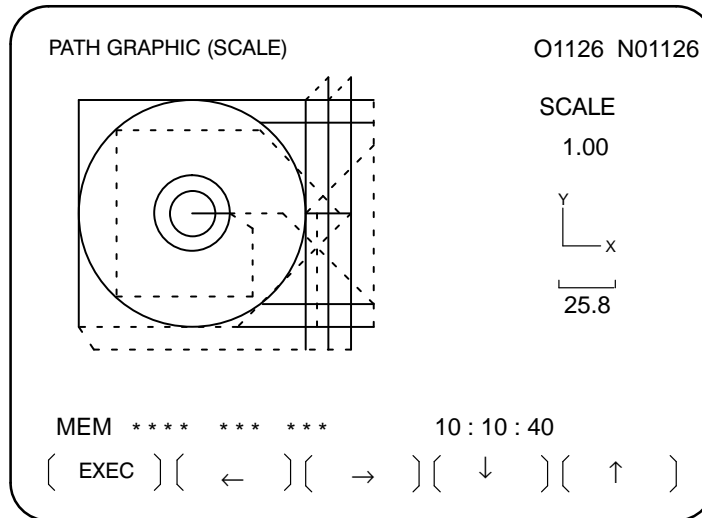
- 6 Set the operation mode to the memory mode, press function key , and call the part program which should be drawn.
- 7 Press function key  () for a small MDI) several times to redisplay the PATH GRAPHIC (PARAMETER) screen, then press soft key **[EXEC]** to display the PATH GRAPHIC (EXECUTION) screen.



- 8 Press soft key **[(OPRT)]**, then press soft key **[AUTO]** or **[START]**. Pressing **[AUTO]** enables automatic scaling. See item 7 in introduction of path drawing and the description of soft key **[AUTO]** in Explanations for details. Drawing is now started. During drawing, the message "DRAWING" blinks at the lower-right corner of the CRT screen.
- 9 Press soft key **[STOP]** to pause drawing. The indication of "STOP" blinks at the lower right corner on the CRT screen. Press soft key **[START]** to start drawing. In addition, press soft key **[REWIND]** to redraw from the top of program before pressing soft key **[START]**.
- 10 Execute the last of part program (M02/M30) to end drawing. This will cause, blinking of the "DRAWING" light to turn off. The tool path view drawn can be retained until the power is turned off unless a new tool path view is drawn.

## Partial enlargement

- 11** For partial drawing enlargement, display the PATH GRAPHIC (SCALE) screen by pressing the soft key **[ZOOM]** on the PATH GRAPHIC (PARAMETER) screen of **step 1** above. The tool path is displayed. Next, press soft key **[(OPRT)]**.



- 12** Perform positioning of marks displayed at the center of the screen to the center of the part enlarged using soft keys **[←]**, **[→]**, **[↓]**, and **[↑]**.
- 13** Set the relative magnification rate for the tool path view which is being drawn using the address keys “P” and “M”. When you press address key P or M, the following results:

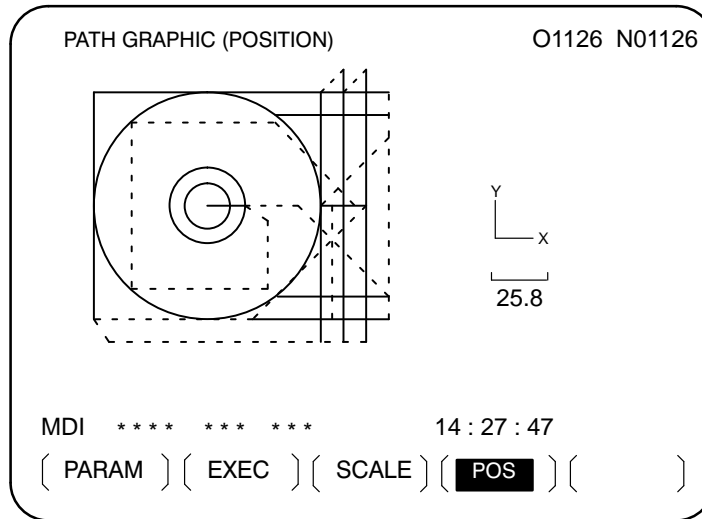
| Address key | Function                                          |
|-------------|---------------------------------------------------|
| P           | The relative magnification rate increases by 0.1. |
| M           | The relative magnification rate decreases by 0.1. |

The relative magnification rate is continuously changed by keeping the address keys depressed. It is possible to magnify up to 100 times in reference to the actual dimensions.

- 14** Press the soft key **[EXEC]** after setting the relative magnification rate. Then, the screen automatically changes to “TOOL PATH (EXECUTION)” and the drawing of set partial enlargement view starts. The set partial enlargement status is valid until soft key **[AUTO]** or **[ERASE]** is pressed.

**Mark display**

- 15 To display a mark at the current tool position**, display the PATH GRAPHIC (POSITION) screen by pressing soft key **[POS]** on the PATH GRAPHIC (PARAMETER) screen of **step 1** above. This mark blinks at the current tool center position on the tool path.



**Explanations**

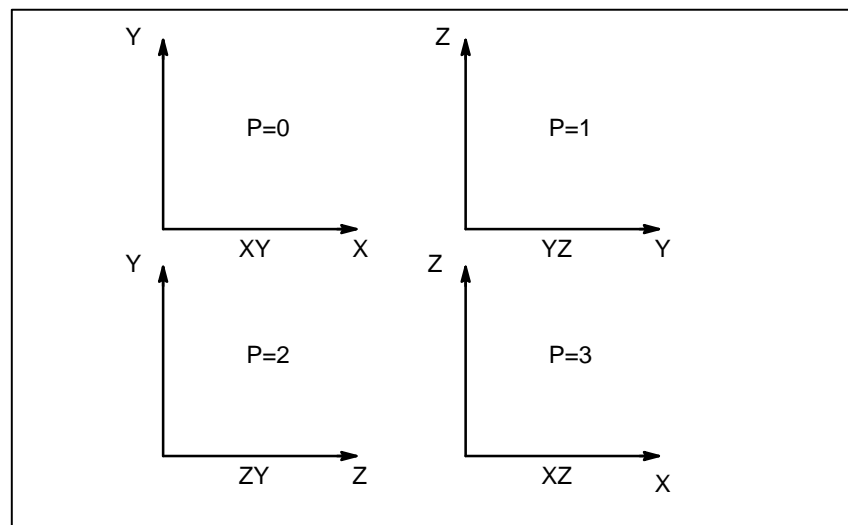
- **AXES**

The relationship between the setting value and drawing screen is as shown below:

| Setting value | Drawing screen             |
|---------------|----------------------------|
| 0             | Plane view (XY)            |
| 1             | Plane view (YZ)            |
| 2             | Plane view (ZY)            |
| 3             | Plane view (XZ)            |
| 4             | Isometric projection (XYZ) |
| 5             | Isometric projection (ZXY) |
| 6             | Biplane view (XY,XZ)       |

- **Plane view (XY,YZ,ZY,XZ)**

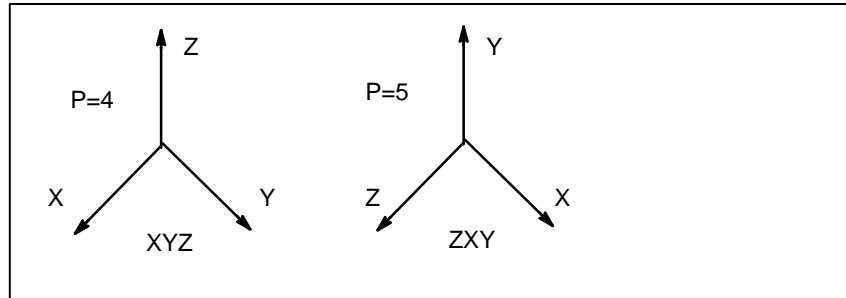
The following coordinate systems are selected.



**Fig. 12.1(e) Coordinate systems for the plane view**

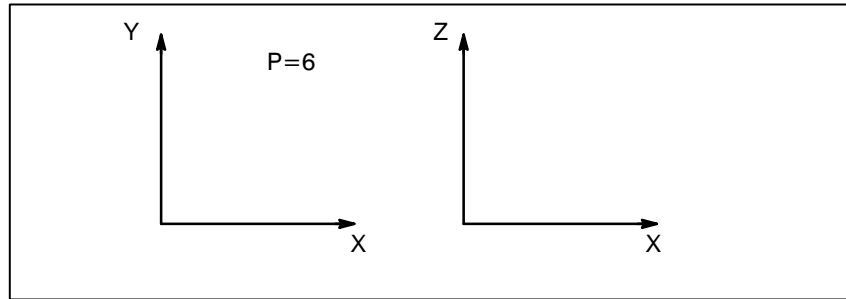
● **Isometric projection (XYZ,ZXY)**

Projector view by isometric can be drawn.



**Fig.12.1(f) Coordinate systems for the isometric projection**

● **Biplane view**



**Fig.12.1 (g) Coordinate systems for the biplane view**

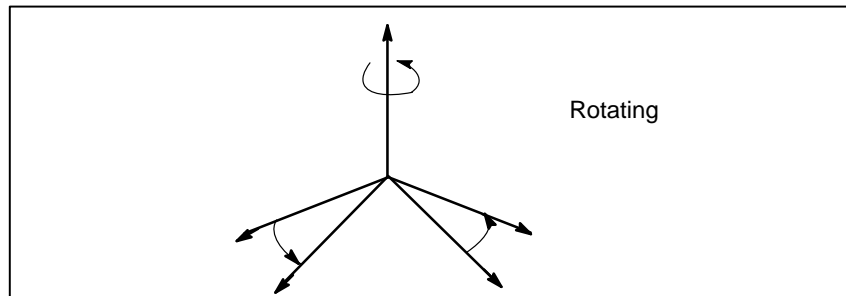
Biplanes (XY and XZ) can be drawn simultaneously. The maximum and minimum coordinate values must be set to draw the biplane view. The maximum and minimum coordinate values can also be set by performing automatic scaling

● **ANGLE**

The direction of the coordinate axis is set when the isometric projection is the setting of the drawing screen. The direction is set by horizontal and vertical rotation angles. The unit is expressed in degrees.

● **ROTATION**

The horizontal rotation angle is set in the range of  $-180^{\circ}$  to  $+180^{\circ}$  in reference to the vertical axis. Set a positive value for clockwise rotation of the coordinate axis. Thus, the direction of projection (visual arrow) becomes counterclockwise.



**Fig.12.1 (h) Rotating**

- **TILTING**

The tilting angle of the vertical axis is set in the range of  $-90^{\circ}$  to  $+90^{\circ}$  in reference to the horizontal axis crossing the vertical axis at a right angle. When a positive value is set, the vertical axis slants to the other side of the graphic screen. Thus, the projection direction (arrow direction) becomes the horizontal direction.

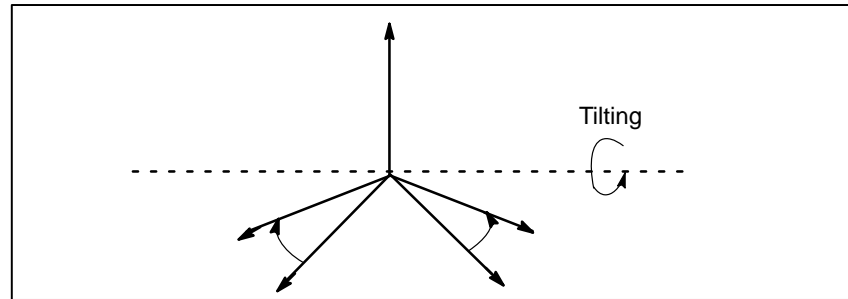


Fig.12.1 (i) Tilting

- **SCALE**

Set the magnification rate of drawing from 0.01 to 100.00. When 1.0 is set, drawing is carried out in actual dimensions. When 0 is set, the drawing magnification rate is automatically set based on the setting of maximum and minimum coordinate values of drawing.

- **CENTER OR MAX./MIN.**

When a graphics (drawing) magnification of 0 is set, maximum coordinates on the X-axis, Y-axis, and Z-axis in the workpiece coordinate system must be set in addresses X, Y, and Z, and minimum coordinates must be set in addresses I, J, and K, to specify the graphics (drawing) range. For biplane view drawing, maximum and minimum coordinates for drawing must be specified.

When a drawing magnification other than 0 is set, the X, Y, and Z coordinates of the drawing center in the workpiece coordinate system must be set in addresses X, Y, and Z. Addresses I, J, and K are not used. The table below summarizes the setting requirements described above.

| Setting the drawing magnification rate | Setting                                              |                                                      |
|----------------------------------------|------------------------------------------------------|------------------------------------------------------|
|                                        | Address X/Y/Z                                        | Address I/J/K                                        |
| Other than 0                           | Drawing center coordinate value of X, Y, and Z axes  | Ignored                                              |
| 0 or biplane view drawing              | Drawing maximum coordinate value of X, Y, and Z axes | Drawing minimum coordinate value of X, Y, and Z axes |

- **START SEQ. NO. and END SEQ. NO.**

Set the start and end sequence numbers of drawing in five digits each. The part program for drawing is executed from the head and only the part enclosed by the start sequence and end sequence numbers is drawn. When 0 is commanded as the start sequence number, drawing is performed from the head of the program. In addition, when 0 is commanded as the end sequence number, drawing is performed up to the end of program. The sequence number is referred to regardless of either main program or subprogram.

- **TOOL COMP.**

It is possible to set whether the tool path is drawn by making the tool length offset or cutter compensation valid or invalid.

| Setting value | Tool length offset or cutter compensation                                         |
|---------------|-----------------------------------------------------------------------------------|
| 0             | Perform drawing by making tool compensation valid (An actual tool path is drawn.) |
| 1             | Perform drawing by making tool compensation invalid (A programmed path is drawn.) |

Always set 0 before drawing when indicating the mark of the current tool position.

- **COLOR**

Specify the color of the tool path. In the case of monochrome it is not required to set it. The relationship between the setting value and color is as shown below:

| Setting value | Color      |
|---------------|------------|
| 0             | White      |
| 1             | Red        |
| 2             | Green      |
| 3             | Yellow     |
| 4             | Blue       |
| 5             | Purple     |
| 6             | Light blue |

- **PATH** Specify the color of the tool path.
- **TOOL** Specify the color of the current position mark of the tool.
- **AUTO CHANGE** Set if for changing the color of the tool path automatically according to the T-code command.

| Setting value | Function                                             |
|---------------|------------------------------------------------------|
| 0             | The color of the tool path is not changed.           |
| 1             | The color of the tool path is changed automatically. |

When 1 is set, the setting value of the color designation of PATH is incremented by 1 every time the T code is commanded. At the same time, the color of the tool path changes. If the setting value exceeds 6, it returns to 0.

- **Soft key functions on the "PATH GRAPHIC [EXECUTION]" screen**

| Software key | Function                                                                                                                                                                                                                                                                                                                           |
|--------------|------------------------------------------------------------------------------------------------------------------------------------------------------------------------------------------------------------------------------------------------------------------------------------------------------------------------------------|
| [AUTO]       | Automatic scaling is performed. Obtain the maximum and minimum coordinates of the part program before performing drawing, specify them for the maximum and minimum values of drawing parameters, and set the drawing magnification rate to 0 before starting drawing. Thus, the tool path view is properly laid out on the screen. |
| [START]      | Drawing starts. When the <b>[START]</b> is pressed while the drawing is not in STOP, the part program starts from the top of the part program. Press the <b>[START]</b> while the drawing is in stop to allow drawing to be carried out continuously.                                                                              |
| [STOP]       | Stop drawing. (Single block stop)                                                                                                                                                                                                                                                                                                  |
| [REWIND]     | Press this key to start drawing from the top of part program. Searches for the beginning of a part program.                                                                                                                                                                                                                        |
| [ERASE]      | Erase the tool path view which has been drawn.                                                                                                                                                                                                                                                                                     |

- **Graphic program** No part program which has not been registered in memory can be drawn. Also, it is necessary that the M02 or M30 should be commanded at the end of the part program.
- **Mark for the tool current position** The period of mark blinking is short when the tool is moving and becomes longer when the tool stops. The mark indicating the current position of tool is displayed on the XY plane view when the biplane drawing is performed.
- **Position mark** Parameter 6501 (CSR, bit 5) is used to specify whether to use ■ or x as the mark for indicating the current tool position and the center of a partially enlarged drawing.
- **Display of the coordinate value** Parameter 6500 (DPO, bit 5) is used to specify whether to display the coordinates of the current position on the tool path drawing screen.
- **Changing the coordinate system** If a program specifies a coordinate system change, parameter 6501 (ORG, bit 0) is used to specify whether to draw without changing the coordinate system or to draw by regarding the current drawing position as the current position in the new coordinate system.

## Restrictions

- **Graphic condition** If machine operation is not allowed, no drawing can be carried out. No drawing can be made during machine operation. The setting data and switches required for drawing are as shown below:

| Setting data and switch | Status                                                                              |
|-------------------------|-------------------------------------------------------------------------------------|
| Tool offset amount      | Set it properly when performing drawing while the tool offset amount becomes valid. |
| Single block            | Off                                                                                 |
| Optional block skip     | Set it properly.                                                                    |
| Feed hold               | Off                                                                                 |

- **Partial enlargement** The partial enlargement can be carried out on the plane view and isometric projection view. No partial enlargement can be made in the drawing of the biplane view.
- **Tool current position** In dynamic graphics display, drawing cannot be executed while the machine is operating even though this is possible in ordinary graphics display (see III-12.1). However, after drawing is executed, the operator can see how the tool moves along the tool path by operating the machine while displaying the mark for the current position of the tool. It is necessary that the setting data and switches related to the machine operation should be the same status between drawing operation and machining operation for properly displaying the current position of tool on the drawn tool path.
- **Two-path lathe control** For the two-path lathe control, two paths can not be displayed at the same time.



## 12.2.2 Solid Graphics

The solid graphics draws the figure of a workpieces machined by the movement of a tool.

The following graphic functions are provided :

1. Solid model graphic  
Solid model graphic is drawn by surfaces so that the machined figure can be recognized concretely.
2. Blank figure graphics  
It is possible to draw a blank figure before machining.  
A rectangular parallelepiped and a circular column or cylinder can be drawn. A circular column or cylinder parallel to the X-axis, Y-axis, or Z-axis can be selected.
3. Drawing of machining progress  
It is possible to draw the progress of machining by simulation.
4. Drawing of final machined figure  
It is possible to draw the final finish machined figure.
5. Changing of drawing direction  
The user can choose from four drawing directions and eight tilting angles.
6. Plane view graphics  
It is possible to draw XY plane views as well as solid model views. Height of the workpiece is discriminated by color for color or brightness for monochrome.
7. Triplane view graphic  
In addition to a solid drawing, a triplane view can be drawn. The user can choose from four types of plane view and side view positions. The user can freely change the cross-section position of a side view.
8. Horizontal hole machining  
It is possible to install tools in the direction which is parallel to the X or Y axis as well as the Z axis.
9. Tool change during machining  
It is possible to change tools during machining by the part program command.

## Solid graphics drawing procedure


### Procedure

- 1 To draw a machining profile, necessary data must be set beforehand.

So press the function key  ( for the small MDI).

The screen of "SOLID GRAPHIC (PARAMETER)" is displayed.

| SOLID GRAPHIC (PARAMETER) |            | O0000 N00003 |
|---------------------------|------------|--------------|
| BLANK FORM                | P=         |              |
| X= 0.000                  | Y= 0.000   | Z= 0.000     |
| I= 120.000                | J= 100.000 | K= 40.000    |
| TOOL FORM                 | P= 2       |              |
|                           | R= 7.500   | K= 0.000     |
| PROJECTION                | P= 3       |              |
|                           | Q= 1       | R= 0         |
| INTENSITY                 | P= 4       |              |
| (0123456)                 | Q= 2       | R= 1         |
| START SEQ.NO.             | N= 0       |              |
| END SEQ.NO.               | N= 0       |              |
| ANIM. SPEED               | N= 0       |              |
| >_                        |            |              |
| MDI **** * * * *          |            | 14 : 42 : 17 |
| { <b>PARAM</b> }          | { BLANK }  | { EXEC }     |
|                           |            | { REVIEW }   |
|                           |            | { }          |

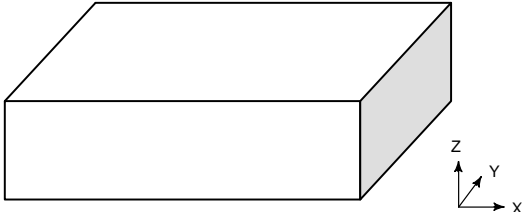
- 2 Use a cursor key to move the cursor to an item to be set.
- 3 Input numerics for the item at the cursor using the numeric key.
- 4 Press the .

Input numerics can be set by these operations and the cursor moves to the next setting item automatically. The set data is retained even if the power is turned off.


See Explanations for details on settings.

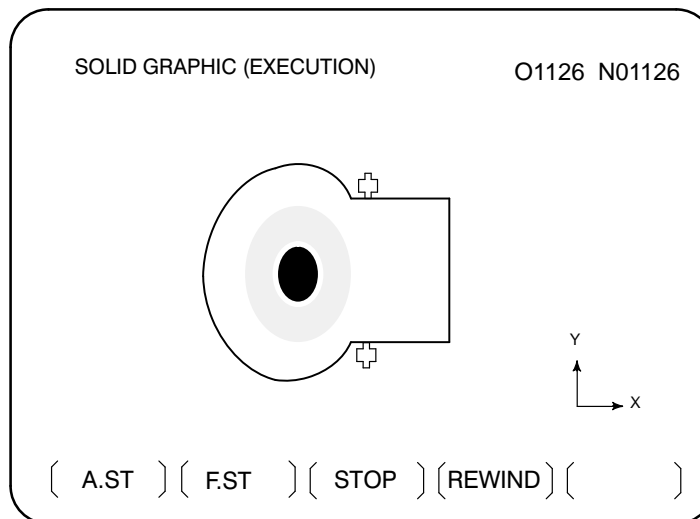
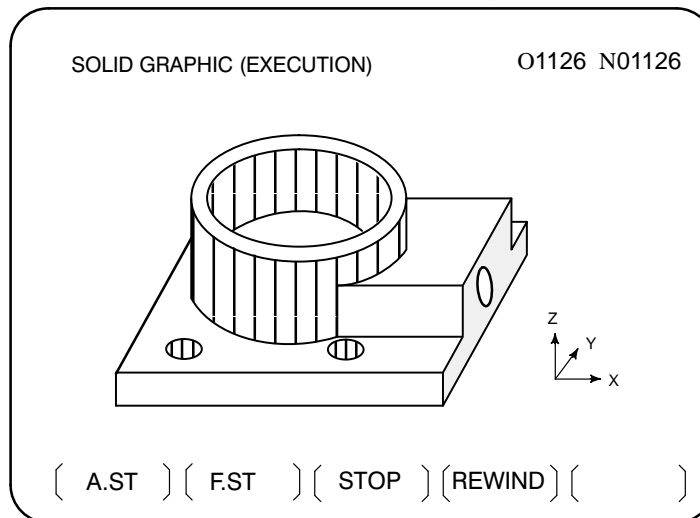
- **SOLID GRAPHIC (BLANK)**

- 5 **To draw a blank figure**, display the SOLID GRAPHIC (BLANK) screen by pressing soft key **[BLANK]** on the SOLID GRAPHIC (PARAMETER) screen of **step 1** above.

| SOLID GRAPHIC (BLANK)                                                                |          | O1126 N1126  |
|--------------------------------------------------------------------------------------|----------|--------------|
|  |          |              |
| MEM **** * * * *                                                                     |          | 10 : 10 : 40 |
| { ANEW }                                                                             | { +ROT } | { -ROT }     |
|                                                                                      |          | { +TILT }    |
|                                                                                      |          | { -TILT }    |

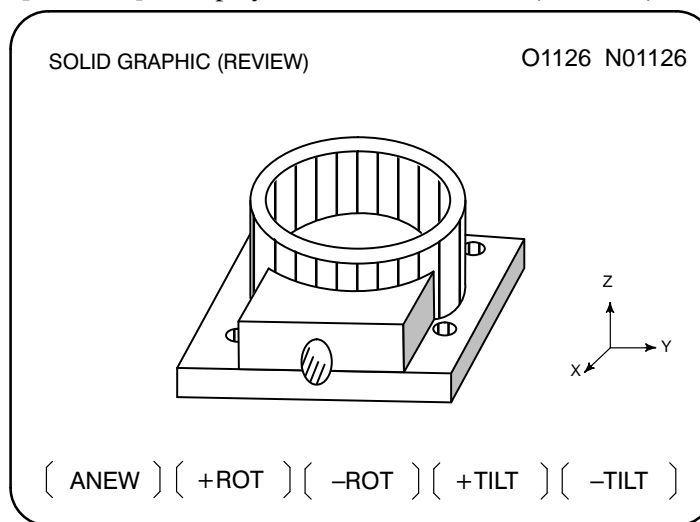
● **SOLID GRAPHICS  
(EXECUTION)**

- 6 Press soft key **[ANEW]**. This allows the blank figure drawing to be performed based on the blank figure data set.
- 7 Press soft keys **[+ROT]** **[-ROT]** **[+TILT]**, and **[-TILT]**, when performing drawing by changing the drawing directions. Parameters P and Q for the drawing direction are changed and the figure is redrawn with the new parameters.
- 8 Set the operation mode to the memory mode, press function key , and call the subject part program of drawing.
- 9 **To draw a machining profile**, display the SOLID GRAPHIC (EXECUTION) screen by pressing soft key **[EXEC]** on the SOLID GRAPHIC (PARAMETER) screen of **step 1** above.



- 10** Press soft key **[(OPRT)]** and press either soft key **[A.ST]** or **[F.ST]**. When **[A.ST]** is pressed, the status of machining in progress is drawn by simulation. When **[F.ST]** is pressed, the profile during machining is not drawn. Only the finished profile produced by the program is drawn. This allows drawing to be started. When “STOP” is not displayed at the lower right corner of the screen, the program is executed from its head. “DRAWING” blinks at the lower right corner of CRT screen during drawing.
- 11** Press soft key **[STOP]** to stop drawing temporarily. Drawing is stopped after drawing the current block and “STOP” blinks at the lower right corner of CRT screen. Press soft key **[A.ST]** or **[F.ST]** when restarting drawing. Press soft key **[REWIND]** and then the **[A.ST]** or **[F.ST]** if redrawing from the head. It is possible to continue drawing after changing the solid graphic parameters in temporary stop.
- 12** When the end of program (M02 or M03) is executed, the drawing ends and the blinking of “DRAWING” stops. Then, the final finish figure is drawn on the CRT screen. The drawn figure view is retained until the power is turned off as long as a new machine figure view is drawn.
- 13** The color, intensity, or drawing direction of a machining figure which has been drawn can be changed and the figure redrawn. To redraw the figure, first change the parameters for the color, intensity, or drawing direction on the SOLID GRAPHIC (PARAMETER) screen shown in **step 1**, then press soft key **[REVIEW]** to display the SOLID GRAPHIC (REVIEW) screen.

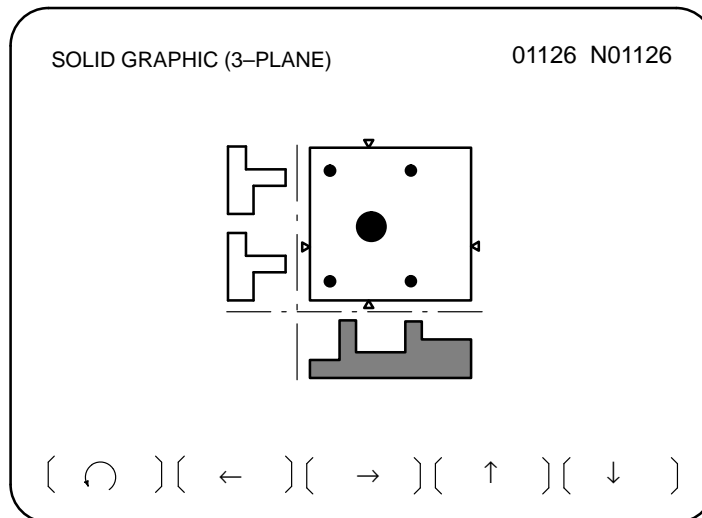
• **REVIEW**




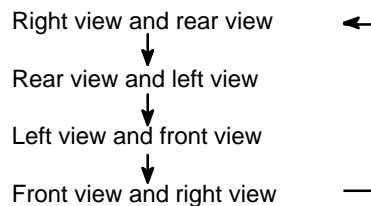
- 14** Press soft key **[(OPRT)]**, then press soft key **[ANEW]**. The machining figure is redrawn with the color, intensity, or drawing direction set in **step 13**.

• **Triplane view drawing**

- 15** To redraw the figure in a different mode, press soft key **[+ROT]**, **[-ROT]**, **[+TILT]**, or **[-TILT]**. Parameters P and Q for the drawing direction are changed and the figure is redrawn with the new parameters.
- 16** The machined figure can be drawn on the tri-plane view. To draw a triplane view, press the rightmost soft key (next-menu key) on the SOLID GRAPHIC (PARAMETER) screen of **step 1** above, then press soft key **[3-PLN]** and **[(OPRT)]**. The SOLID GRAPHIC (3-PLANE) screen appears.



- 17** Each time soft key [  ] is pressed, the side-view drawings displayed change as follows.



- 18** The sectional position of side view can be changed by the soft keys **[←]**, **[→]**, **[↑]**, and **[↓]**.  
 With the sectional position of the left/right side view, the marks ▲ and ▼ indicating the sectional position can be moved using the soft keys **[←]** and **[→]**.  
 With the sectional position of rear/front side view, the marks ► and ◄ indicating the sectional position can be moved using the soft keys **[↑]**, and **[↓]**. Keep the keys depressed to change sectional/views continuously.

## Explanations

### GRAPHICS PARAMETER

#### • BLANK FORM

##### ◆ BLANK FORM (P)

Set the type of blank figure under P. The relationship between the setting value and figure is as follows:

| P | Blank figure                            |
|---|-----------------------------------------|
| 0 | Rectangular parallelepiped (Cubed)      |
| 1 | Column or cylinder (parallel to Z-axis) |
| 2 | Column or cylinder (parallel to X-axis) |
| 3 | Column or cylinder (parallel to Y-axis) |

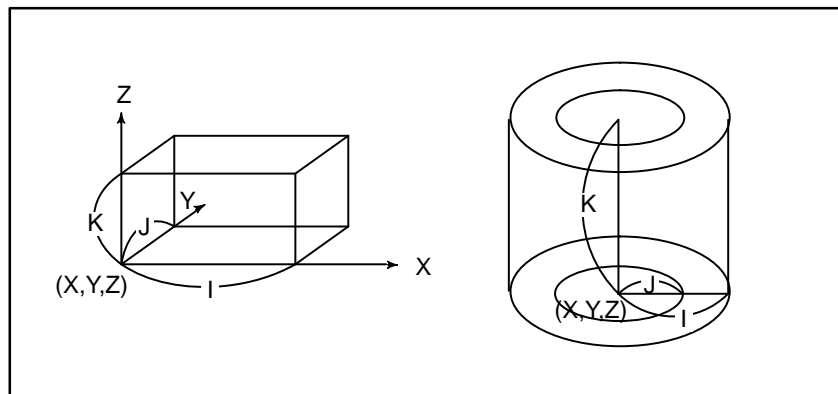
##### ◆ Material positions (X,Y,Z)

Set the X-axis, Y-axis, and Z-axis coordinate values of standard point of materials in workpiece coordinate system to the addresses X, Y, and Z. The standard point of materials is the corner point in the negative direction in the case of rectangular parallelepiped blank figure and the center point of bottom in the case of column and cylinder materials.

##### ◆ Material dimensions (I,J,K)

Set the dimensions of materials. The relationship between the addresses I, J, and K and setting value is as shown below:

| Material    | I                          | J                          | K                          |
|-------------|----------------------------|----------------------------|----------------------------|
| Rectangular | Length in X-axis direction | Length in Y-axis direction | Length in Z-axis direction |
| Column      | Radius of circle           | 0                          | Length of column           |
| Cylinder    | Radius of external circle  | Radius of internal circle  | Length of cylinder         |



## ● TOOL FORM

- ◆ Machining tool orientation (P)

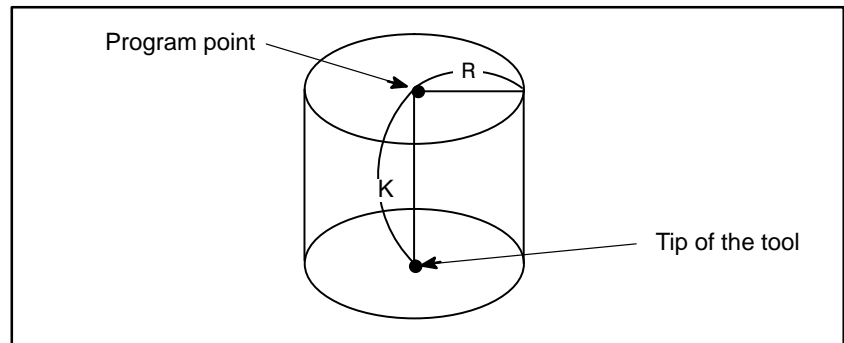
Set the machining direction of tools. The relationship between the setting value and machining direction is as shown below.

| P   | Machining direction of tools                                    |
|-----|-----------------------------------------------------------------|
| 0,1 | Parallel to the Z-axis (perform machining from the + direction) |
| 2   | Parallel to the X-axis (perform machining from the + direction) |
| 3   | Parallel to the Y-axis (perform machining from the + direction) |
| 4   | Parallel to the Z-axis (perform machining from the – direction) |
| 5   | Parallel to the X-axis (perform machining from the – direction) |
| 6   | Parallel to the Y-axis (perform machining from the – direction) |

- ◆ Dimensions of tools (R,K)

Set the dimensions of tool. The relationship between the displayed address and setting value is as shown below:

| Address | Setting numerics                                         |
|---------|----------------------------------------------------------|
| R       | Radius of tool                                           |
| K       | Distance from the program point to tool tip (normally 0) |



## ● PROJECTION

- ◆ Graphics method and direction (P)

The relationship between graphic method and direction and setting value is as shown below:

| P    | Graphic method and direction       |
|------|------------------------------------|
| 0, 4 | Oblique projection view (+ X-axis) |
| 1, 5 | Oblique projection view (+ Y-axis) |
| 2, 6 | Oblique projection view (– X-axis) |
| 3, 7 | Oblique projection view (–Y-axis)  |

This setting value can also be incremented or decremented by the soft keys **[+ROT]** or **[– ROT]**. In this case, if the setting value exceeds 7, it returns to 0. If it is smaller than 0, it becomes 7.

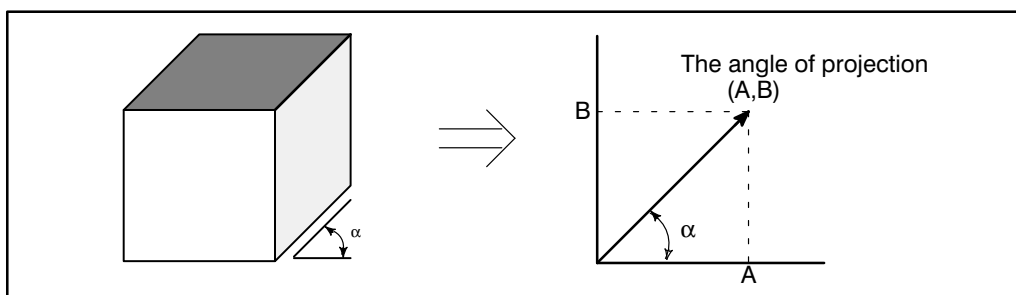
◆ Tilting angle (Q)

Set the slant direction of the projection axis in the case of oblique projection drawing. Moreover, plane view can be specified. The relationship between the setting value and slant direction is as shown below:

| Q  | Slant direction                                         |
|----|---------------------------------------------------------|
| 3  | Plane view                                              |
| 2  | (0,2) direction ; $\alpha=90^\circ$ in the figure below |
| 1  | (1,2) direction ; $\alpha=60^\circ$ in the figure below |
| 0  | (2,2) direction ; $\alpha=45^\circ$ in the figure below |
| -1 | (2,1) direction ; $\alpha=30^\circ$ in the figure below |
| -2 | (2,0) direction ; $\alpha=0^\circ$ in the figure below  |

This setting value can also be incremented or decremented by 1 using soft key **[+ TILT]** or **[-TILT]**.

Example) The angle of projection is changed by the set value.



Variations of the above figure determined by set values are shown below.

|                                                   |                                                |                                                 |
|---------------------------------------------------|------------------------------------------------|-------------------------------------------------|
| (i) Set value: 3<br><br>(Two-dimensional drawing) | (ii) Set value: 2<br><br>( $\alpha=90^\circ$ ) | (iii) Set value: 1<br><br>( $\alpha=60^\circ$ ) |
| (iv) Set value: 0<br><br>( $\alpha=45^\circ$ )    | (v) Set value: -1<br><br>( $\alpha=30^\circ$ ) | (vi) Set value: -2<br><br>( $\alpha=0^\circ$ )  |



- ◆ VERTICAL AXIS (R) Set the direction of the vertical axis.

| R    | VERTICAL AXIS |
|------|---------------|
| 0, 1 | Z-axis        |
| 2    | X-axis        |
| 3    | Y-axis        |

The direction of the vertical axis which is set is effective by executing graph.

● INTENSITY

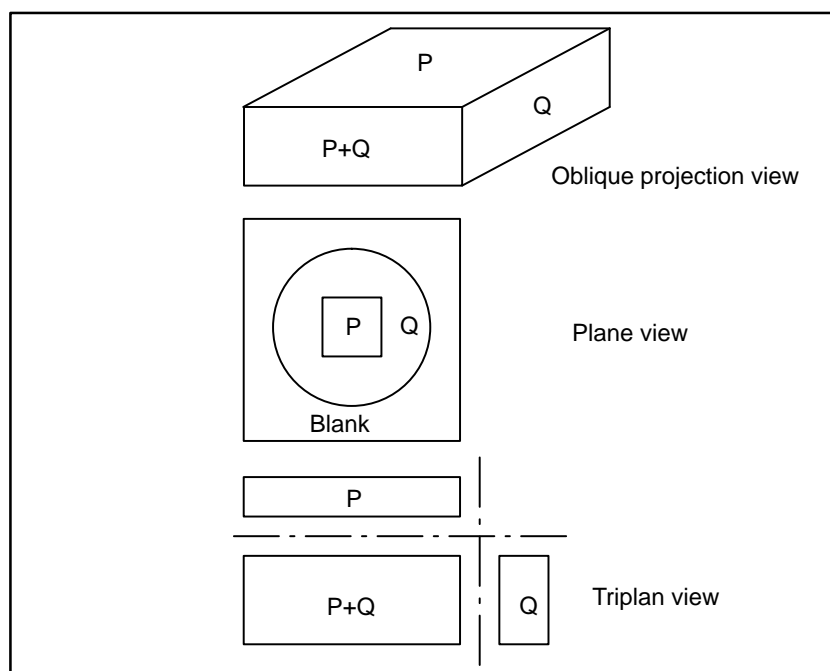
Specify the intensity of the drawing screen when performing drawing on the monochrome, and the color of the drawing screen when performing drawing on the color screen. The relationship between the setting, intensity, and color is as shown below:

However, when the plane view is displayed on the monochrome. The brighter surface, whichever is specified by P or Q becomes the top surface.

| Setting value | Intensity          | Color      |
|---------------|--------------------|------------|
| 0             | Maximum brightness | White      |
| 1             | Dark<br>↓<br>Light | Red        |
| 2             |                    | Green      |
| 3             |                    | Yellow     |
| 4             |                    | Blue       |
| 5             |                    | Purple     |
| 6             |                    | Light blue |

The relationship between the display address, surface, and line on the machined figure view is as shown below:

| Address | Oblique projection view                                 | Plane view             | Triplane view                                        |
|---------|---------------------------------------------------------|------------------------|------------------------------------------------------|
| P       | Upper surface                                           | Upper surface          | Upper/lower surface                                  |
| Q       | Side surface                                            | Middle surface         | Left/right surface                                   |
| R       | Ridge                                                   | Ridge                  | Ridge                                                |
| Remarks | The intensity/color of front surface is between P and Q | Lower surface is blank | The intensity/color of plane view is between P and Q |



- **START SEQ. NO. and END SEQ. NO.**

Specify the start sequence number and end sequence number of each drawing in a five-digit numeric. The subject part program is executed from the head. But only the part enclosed by the start sequence number and end sequence numeric is drawn. When 0 is commanded as the start sequence number, the program is drawn from its head. When 0 is commanded as the end sequence number, the program is drawn to its end. The comparison of sequence number is performed regardless of main program and subprogram.

- **ANIM. SPEED**

Set interval of animated simulation drawing ranging from 0 to 255. Every time the machining proceeds by the number set, the drawing is repeated. If 0 is set, drawing is repeated at every 1 block execution.

- **Soft key functions on the "SOLID GRAPHIC (EXECUTION)" screen**

| Soft key | Function                                                                                                                                      |
|----------|-----------------------------------------------------------------------------------------------------------------------------------------------|
| [A.ST]   | Simulate and draw the progress of machining.                                                                                                  |
| [F.ST]   | No figure during machining is drawn and only the final finish figure by that program is drawn.                                                |
| [STOP]   | When pressed, stops drawing at the end of block (single block stop).                                                                          |
| [REWIND] | Press this key to perform drawing from the head of part program. Heading is performed automatically after execution of program end (M02/M30). |

- **Graphics program**

No part program which has not been registered in memory can be drawn. It is also necessary that the M02 or M30 be commanded at the end of the part program.

- **Specifying the blank form and tool form in the part program**

It is possible to specify BLANK FORM and TOOL FORM in the part program. The command format is as shown below. If it is commanded during execution of drawing, the item corresponding to the screen of “SOLID GRAPHIC (PARAMETER)” is set and drawing continues with the set data.

- Command of BLANK FORM

```
G10 L90 P_X_Y_Z_I_J_K_;
```

The command value succeeding the address is the same as the numeric set to the address being displayed at the item of BLANK FORM of “SOLID GRAPHIC (PARAMETER)”. If BLANK FORM is commanded, drawing continues after a new blank figure is drawn.

- Command of TOOL FORM

```
G10 L91 P_R_K_;
```

The command value succeeding the address is the same as the numeric set to the address being displayed at the item of TOOL FORM of screen “SOLID GRAPHIC (PARAMETER)”. If 0 is commanded with the tool radius value, no machining simulation is performed thereafter.

- **Display of the coordinate value**

Parameter 6500 (DPO, bit 5) is used to specify whether to display the coordinates of the current position on SOLID GRAPHIC screen.

- **TOOL COMP.**

In solid graphics, parameter 6501 (TLC, bit 1) is used to specify whether to apply tool length offset.

- **Graphic method**

Parameter 6501 (3PL, bit 2) is used to select whether to draw a triplane view with the third-angle or first-angle projection.

- **Ridge drawing**

Parameter 6501 (RID, bit 3) is used to specify whether to draw ridges in plane view drawing.

- **Display mode**

Parameter 6501 (FIM, bit 4) is used to specify whether to display a solid graphics in the rough mode or in the fine mode. When a solid graphics is drawn in the fine mode, the drawing speed is slower than when drawn in the rough mode.

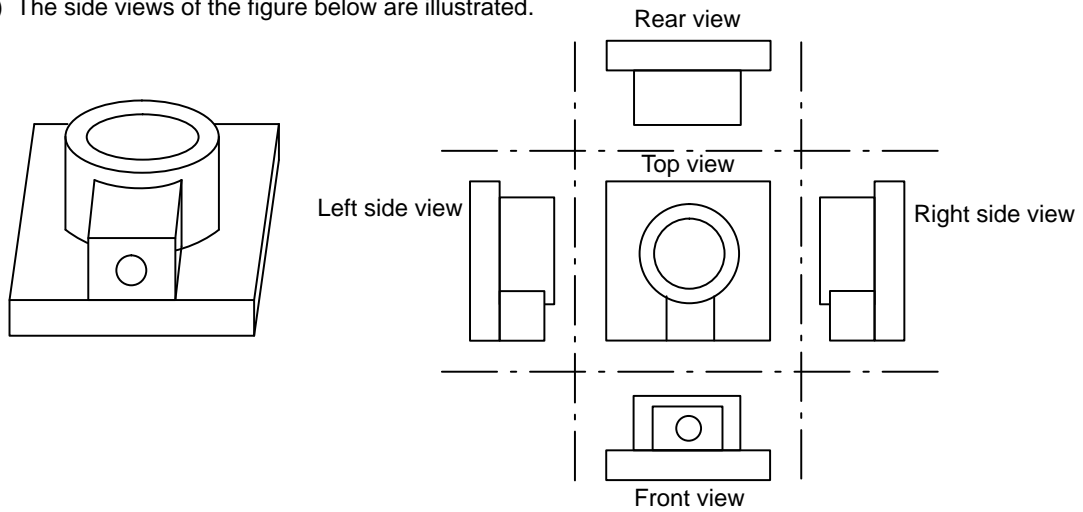
- **Cross section position change**

In triplane drawing, a value can be specified for changing the position of the cross section while the soft key is held down. A value from 0 to 10 can be set. When 0 is specified, a value of 1 is used. (Parameter No. 6515)

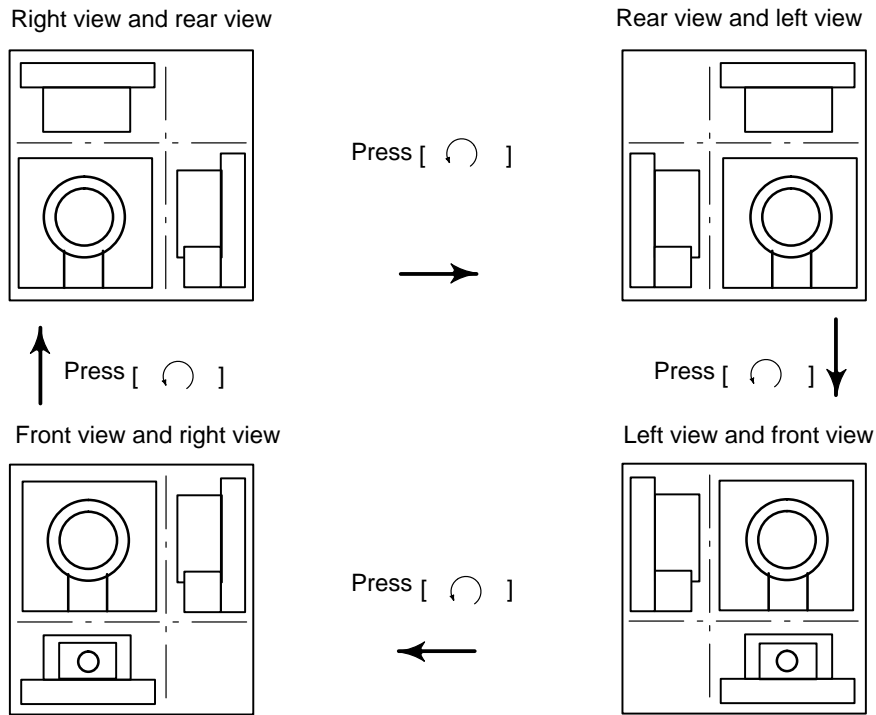
**Examples**

- **Side view selection in triplane drawing**

Example) The side views of the figure below are illustrated.

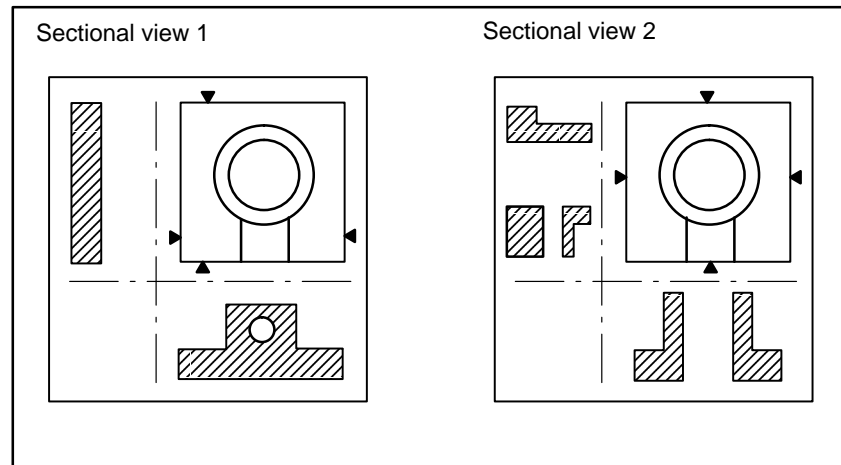


In the above figure, the side views displayed are switched as follows.



- **Cross section position selection in triplane drawing**

Some examples of cross-sectional views are given below for the left view and front view shown on the previous page.



### Limitations

- **Graphic condition**

If the machine operation is not enabled, no drawing can be made. No drawing can be made during operation of machine. The main setting data and switches needed on drawing are as shown below:

| Setting data/switch | Status needed for drawing                                                                         |
|---------------------|---------------------------------------------------------------------------------------------------|
| Tool offset value   | It is necessary to set the cutter compensation value properly. The tool length offset is ignored. |
| Single block        | Off                                                                                               |
| Optional block skip | Properly set it.                                                                                  |
| Feed hold           | Off                                                                                               |

- **Tool form**

Tools which set the tool figure are limited to the cylinder figure (equivalent to flat end mill).

- **Helical interpolation**

In solid graphics, paths based on helical interpolation cannot be drawn.

- **Two-path lathe control**



For the two-path lathe control, two paths can not be displayed at the same time.

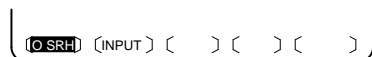
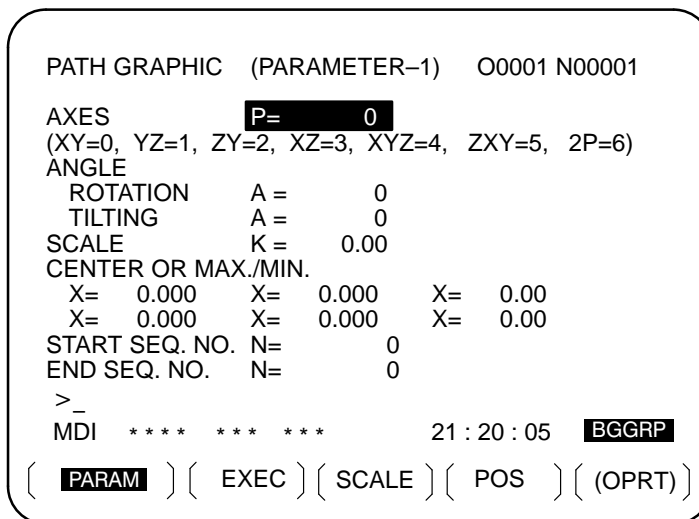
## 12.3 BACKGROUND DRAWING

The background drawing function enables the drawing of a figure for one program while machining a workpiece under the control of another program.


### Procedure for Background Drawing


#### Procedure

- 1 Press the  function key ( for a small MDI).
- 2 Press the **[PARAM]** soft key. The following screen appears:



- 3 Press the **[OPRT]** soft key.
- 4 To select the program to be used for drawing, enter the number of that program, then press the **[O SRH]** soft key. (The O number at the top right of the screen indicates the selected program.) Repeatedly pressing only the **[O SRH]** soft key selects the registered programs in turn.

To input a graphic parameter, the **[INPUT]** soft key can be used instead of the  MDI key.

- 5 Press the left-most soft key  (return menu key), to return the soft keys to the state existing upon the completion of step 2.
- 6 Perform dynamic graphic display, as described in Section III-12.2.

#### Explanations

##### • Program selection

Immediately after entering background drawing mode, the program which was selected previously remains selected. Any program can be selected for background drawing, by using the background drawing screen.


If no program is selected prior to entering background drawing mode, the program number is set to 0. In such a case, drawing cannot be started until the program to be used for drawing is specified.



- **Tool offsets**

Separate tool offsets are internally provided for machining and background drawing. Upon starting drawing or when selecting a program for drawing, the tool offset data for machining is copied to the tool offset data for background drawing. Changing a tool offset by using a G10 command during machining does not affect that for background drawing. Similarly, changing a tool offset by using a G10 command during drawing does not affect that for machining.
- **Parameters**

The same parameters are used for both background drawing and actual machining.
- **Workpiece coordinate offsets**

Workpiece coordinate system offsets, part of the parameters, are provided separately for machining and background drawing. Upon selecting a program for drawing, the workpiece coordinate system offset data for machining is copied to the workpiece coordinate system offset data for background drawing. Changing a workpiece coordinate system offset by using a G10 command during machining does not affect that for background drawing. Similarly, changing a workpiece coordinate system offset by using a G10 command during drawing does not affect that for machining.
- **Macro variables**

Macro variables are provided separately for machining and background drawing. Upon selecting a program for drawing, the macro variables for machining are copied to the macro variables for background drawing. Changing a macro variable by using a G10 command during machining does not affect that for background drawing. Similarly, changing a macro variable using a G10 command during drawing does not affect that for machining.
-  **function key**




When bit 6 (BGOF) of parameter No. 3109 is set to 1, pressing the  function key on the background drawing screen displays the tool offsets, workpiece coordinate system offsets, and macro variables for background drawing. In such a case,  is displayed at the bottom right of the screen, to indicate that data for background drawing is being displayed.

- **Displaying the coordinates**

Bit 5 (DPO) of parameter No. 6500 can be used to specify whether the coordinates of the current position are to be displayed on the tool path drawing.

In background drawing mode, modal information F, S, and T is displayed, together with the current position. If the **[POS]** soft key has been selected for dynamic graphic display, however, F, S, and T are not displayed.

**CAUTION**

Once an alarm is issued during background drawing, drawing is stopped and the alarm description is displayed at the bottom right of the screen. To release the alarm state, press the  MDI key. Note that pressing the  key will also stop foreground machining if currently in progress. Note, however, that bit 0 (RST) of parameter No. 8100 can be used to specify that machining will not be stopped if the  key is pressed during background drawing.



# 13 HELP FUNCTION

The help function displays on the screen detailed information about alarms issued in the CNC and about CNC operations. The following information is displayed.

- **Detailed information of alarms**

When the CNC is operated incorrectly or an erroneous machining program is executed, the CNC enters the alarm state. The help screen displays detailed information about the alarm that has been issued and how to reset it. The detailed information is displayed only for a limited number of P/S alarms. These alarms are often misunderstood and are rather difficult to understand.

- **Operation method**


If you are not sure about a CNC operation, refer to the help screen for information about each operation.

- **Parameter table**

When setting or referring to a system parameter, if you are not sure of the number of the parameter, the help screen displays a list of parameter Nos. for each function.

## Help Function Procedure

### Procedure

- 1 Press the  key on the MDI panel. HELP (INITIAL MENU) screen is displayed.

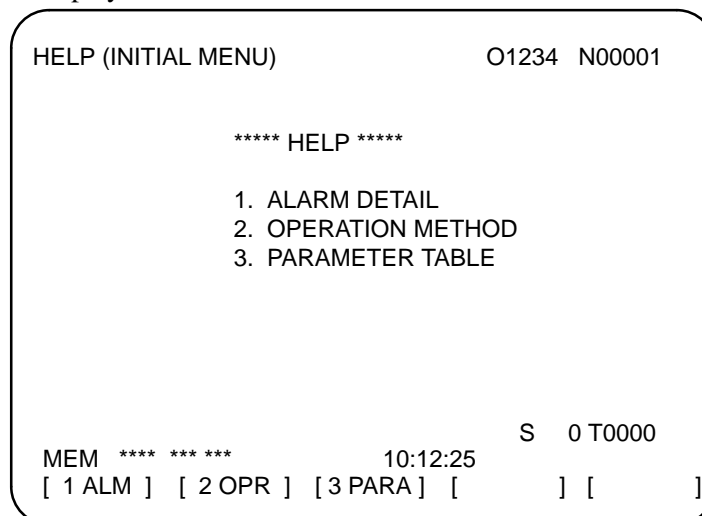

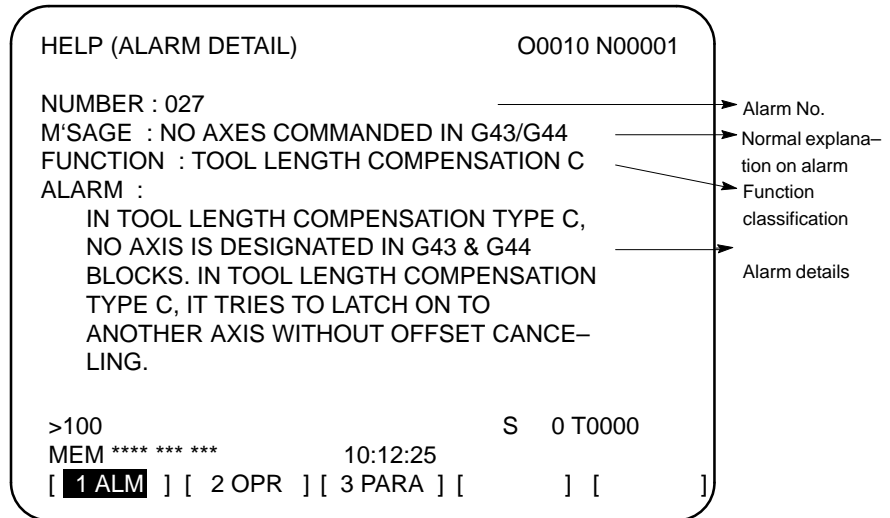


Fig.13(a) HELP (INITIAL MENU) Screen

The user cannot switch the screen display from the PMC screen or CUSTOM screen to the help screen. The user can return to the normal CNC screen by pressing the  key or another function key.

**ALARM DETAIL screen**

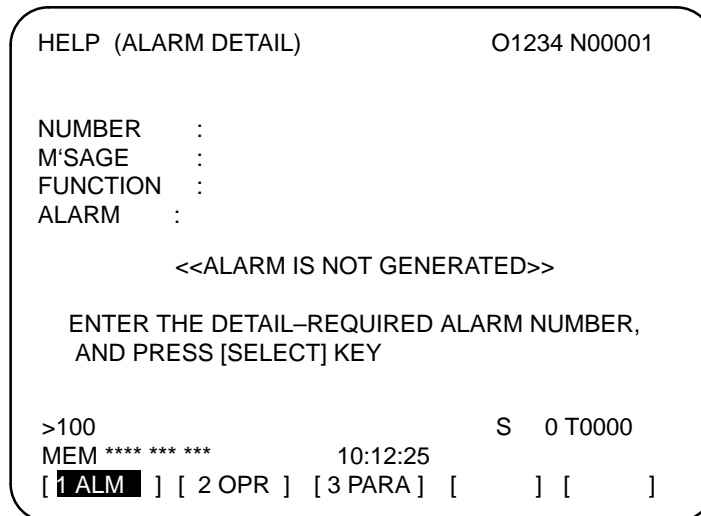
- 2 Press soft key [**1 ALAM**] on the HELP (INITIAL MENU) screen to display detailed information about an alarm currently being raised.



**Fig.13(b) ALARM DETAIL Screen when Alarm P/S 027 is issued**

Note that only details of the alarm identified at the top of the screen are displayed on the screen.

If the alarms are all reset while the help screen is displayed, the alarm displayed on the ALARM DETAIL screen is deleted, indicating that no alarm is issued.



**Fig.13(c) ALARM DETAIL Screen when No Alarm is issued**

- 3 To get details on another alarm number, first enter the alarm number, then press soft key **[SELECT]**. This operation is useful for investigating alarms not currently being raised.

```

>100 S 0 T0000
MEM **** * * * * 10:12:25
[] [] [] [] [SELECT]

```

**Fig.13(d) How to select each ALARM DETAILS**

The following is the screen when P/S alarm 100 is selected as example.

```

HELP (ALARM DETAIL) O1234 N00001

NUMBER : 100
M'SAGE : PARAMETER WRITE ENABLE
FUNCTION :
ALARM :

 <<ALARM IS NOT GENERATED>>

>100 S 0 T0000
MEM **** * * * * 10:12:25
[] [] [] [] [SELECT]

```

**Fig.13(e) ALARM DETAIL Screen when P/S 100 is selected**

#### OPERATION METHOD screen

- 4 To determine an operating procedure for the CNC, press the soft key **[2 OPR]** key on the HELP (INITIAL MENU) screen. The OPERATION METHOD menu screen is then displayed.

```

HELP (OPERATION METHOD) O1234 N00001

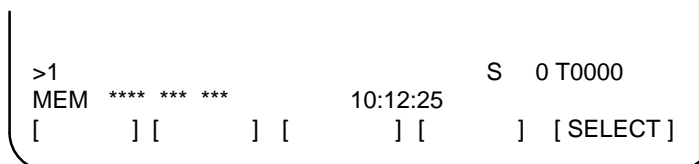
1. PROGRAM EDIT
2. SEARCH
3. RESET
4. DATA INPUT WITH MDI
5. DATA INPUT WITH TAPE
6. OUTPUT
7. INPUT WITH FANUC CASSETTE
8. OUTPUT WITH FANUC CASSETTE
9. MEMORY CLEAR

 S 0 T0000
MEM **** * * * * 00 : 00 : 00
{ 1 ALAM } { 2 OPR } { 3 PARA } { } { (OPRT) }

```

**Fig.13(f) OPERATION METHOD Menu Screen**

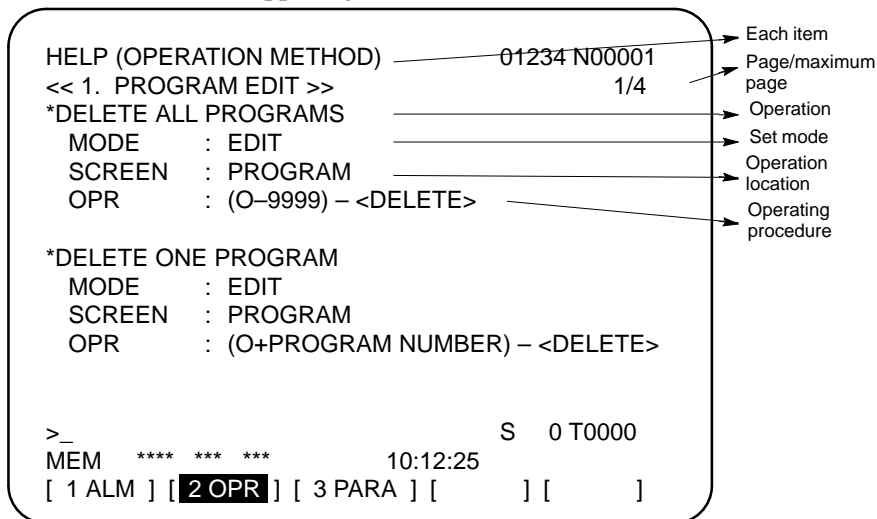
To select an operating procedure, enter an item No. from the keyboard then press the **[SELECT]** key.



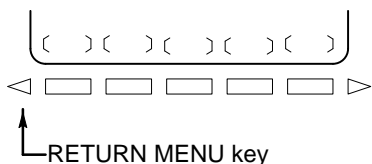
**Fig.13(g) How to select each OPERATION METHOD screen**

When “1. PROGRAM EDIT” is selected, for example, the screen in Figure 13 (h) is displayed.

On each OPERATION METHOD screen, it is possible to change the displayed page by pressing the PAGE key. The current page No. is shown at the upper right corner on the screen.

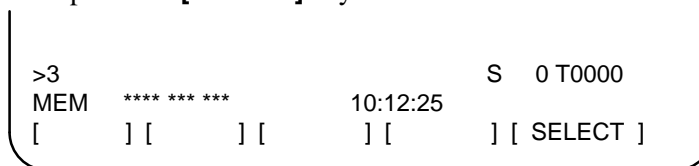


**Fig.13(h) Selected OPERATION METHOD screen**



- To return to the OPERATION METHOD menu screen, press the RETURN MENU key to display “**[2 OPR]**” again, and then press the **[2 OPR]** key again.

To directly select another OPERATION METHOD screen on the screen shown in Figure 13 (h), enter an item No. from the keyboard and press the **[SELECT]** key.



**Fig.13(i) How to select another OPERATION METHOD screen**

**PARAMETER TABLE screen**

- If you are not sure of the No. of a system parameter to be set, or to refer to a system parameter, press the **[3 PARA]** key on the HELP (INITIAL MENU) screen. A list of parameter Nos. for each function is displayed. (See Figure 13 (j).)

It is possible to change the displayed page on the parameter screen.

The current page No. is shown at the upper right corner on the screen.

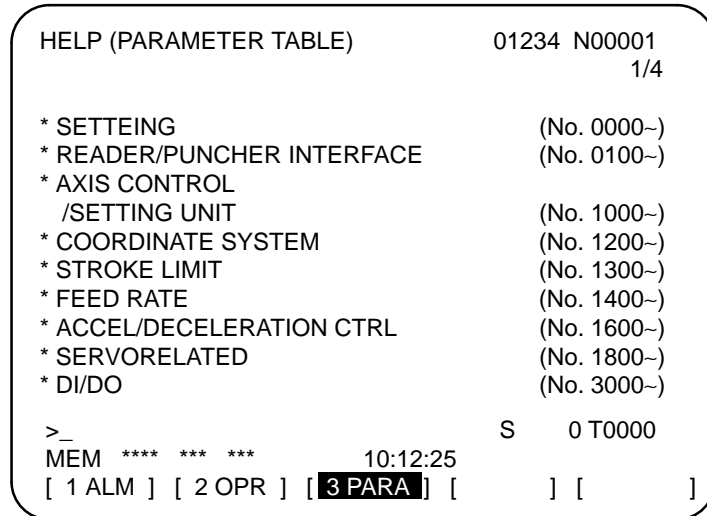
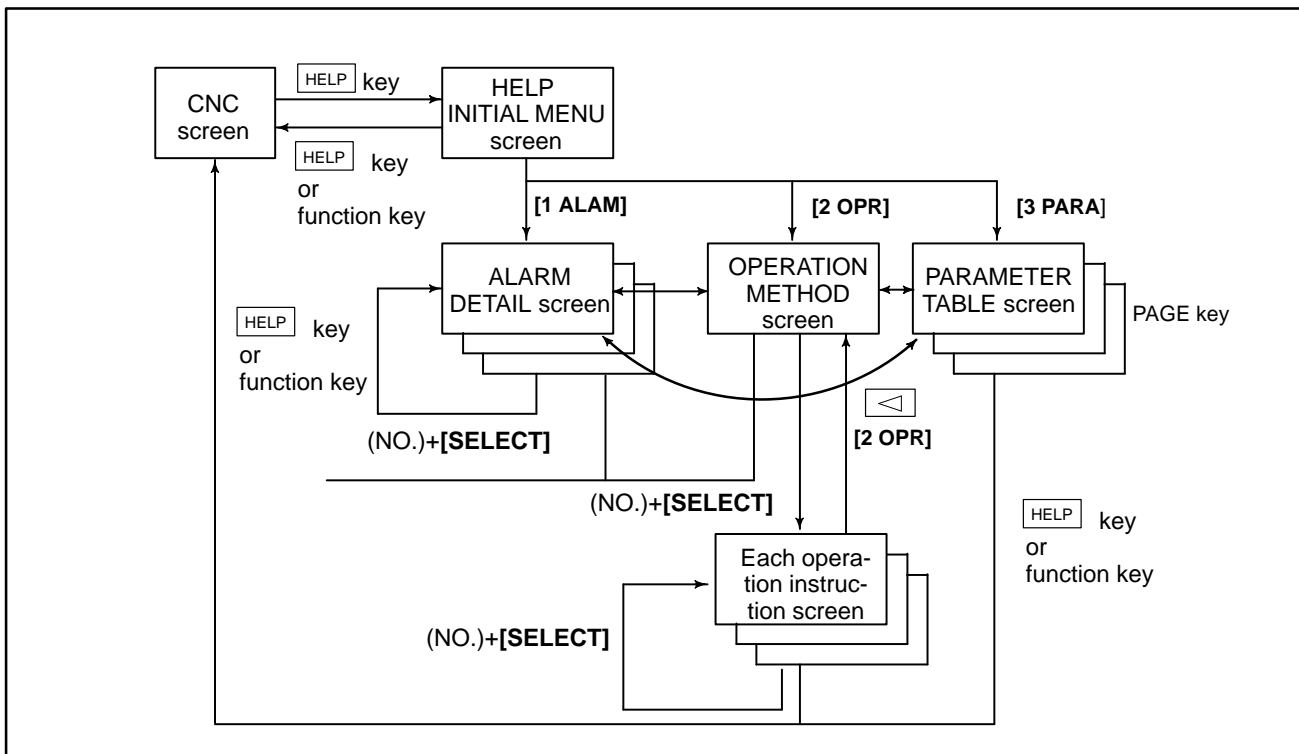


Fig. 13(i) PARAMETER TABLE screen

- 7 To exit from the help screen, press the **HELP** key or another function key.

**Explanation**

- Configuration of the Help Screen



## **IV. MAINTENANCE**

# 1

## METHOD OF REPLACING BATTERY

This chapter describes how to replace the CNC backup battery and absolute pulse coder battery. This chapter consists of the following sections:

### 1.1 REPLACING THE ALKALINE DRY CELLS (SIZE D)

### 1.2 USE OF ALKALINE DRY CELLS (SIZE D)

### 1.3 BATTERY FOR SEPARATE ABSOLUTE PULSE CODERS

#### Battery for memory backup

Part programs, offset data, and system parameters are stored in CMOS memory in the control unit. The power to the CMOS memory is backed up by a lithium battery mounted on the front panel of the control unit. Therefore, the above data is not lost even if the main battery fails. The backup battery is installed in the control unit prior to being shipped from the factory. This battery can provide backup for the memory contents for about a year.

When the battery voltage falls, alarm message "BAT" blinks on the LCD display and the battery alarm signal is output to the PMC. When this alarm is displayed, replace the battery as soon as possible. In general, the battery can be replaced within one or two weeks of the alarm first being issued. This, however, depends on the system configuration.

If the battery voltage subsequently drops further, backup of memory can no longer be provided. Turning on the power to the control unit in this state causes system alarm 910 (SRAM parity alarm) to be issued because the contents of memory are lost. Replace the battery, clear the entire memory, then reenter the data.

Replace the memory backup battery while the control unit is turned off. The following two kinds of batteries can be used.

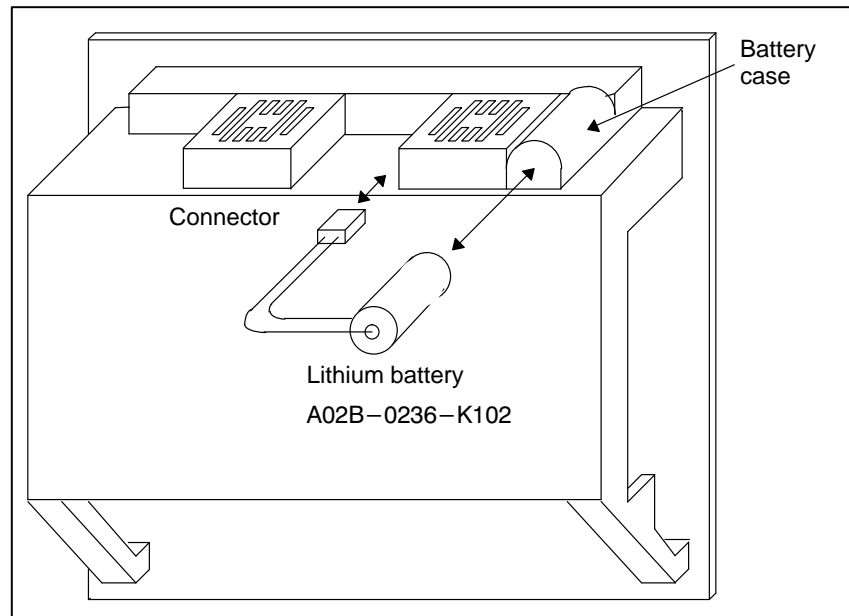
- Lithium battery, incorporated into the CNC control unit.
- Two alkaline dry cells (size D) in an external battery case.

#### NOTE

A lithium battery is installed as standard at the factory.

## Replacing the lithium battery

- 1 Obtain a new lithium battery (ordering drawing number: A02B-0236-K102).
- 2 Turn the Series 16*i*/18*i*/160*i*/180*i* on for about 30 seconds.
- 3 Turn the Series 16*i*/18*i*/160*i*/180*i* off.
- 4 Remove the old battery from the top of the CNC control unit.  
First, disconnect the battery cable then remove the battery from its case. The battery case of a control unit with no option slots is located at the top right end of the unit. That of a control unit with 2 slots or 4 slots is located in the central area of the top of the unit (between fans).



- 5 Insert a new battery and reconnect the cable.

### NOTE

Complete steps 3 to 5 within 30 minutes (within five minutes for the Series 160*i*/180*i* with PC functions).

If the battery is left disconnected for any longer, the contents of memory will be lost.

If for some reason, it may prove impossible to complete the battery replacement within 30 minutes, save the entire contents of the CMOS memory to a memory card in advance. The data can thus be easily restored if the contents of memory are lost.

For an explanation of the operating procedure, refer to the maintenance manual.

### WARNING

Using other than the recommended battery may result in the battery exploding.

Replace the battery only with the specified type (A02B-0236-K102).



Dispose of used batteries as follows:

(1) Small quantities (less than 10)

Discharge the batteries and dispose of them as ordinary unburnable waste.

(2) Large quantities

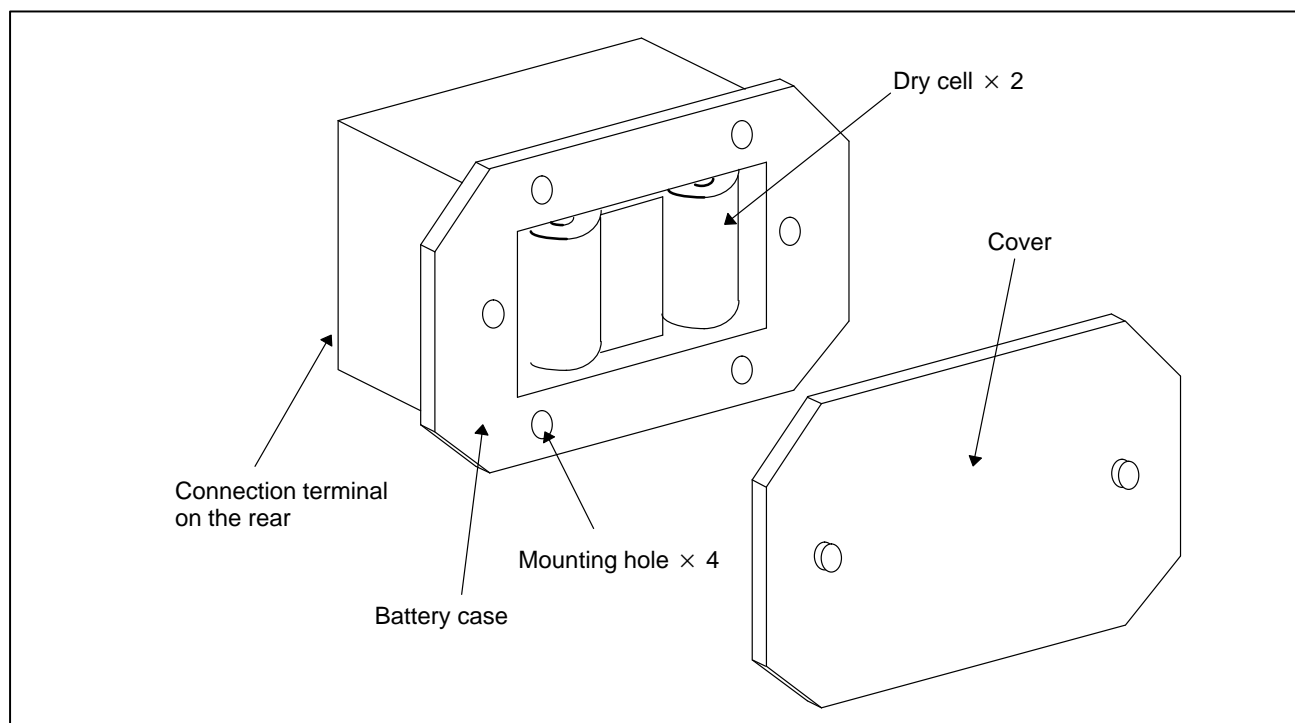
Please consult FANUC.

## 1.1 REPLACING THE ALKALINE DRY CELLS (SIZE D)

- 1 Obtain two new alkaline dry cells (size D).
- 2 Turn the Series 16i/18i/160i/180i on.
- 3 Remove the battery case cover.
- 4 Replace the batteries, paying careful attention to their orientation.
- 5 Replace the battery case cover.

### NOTE

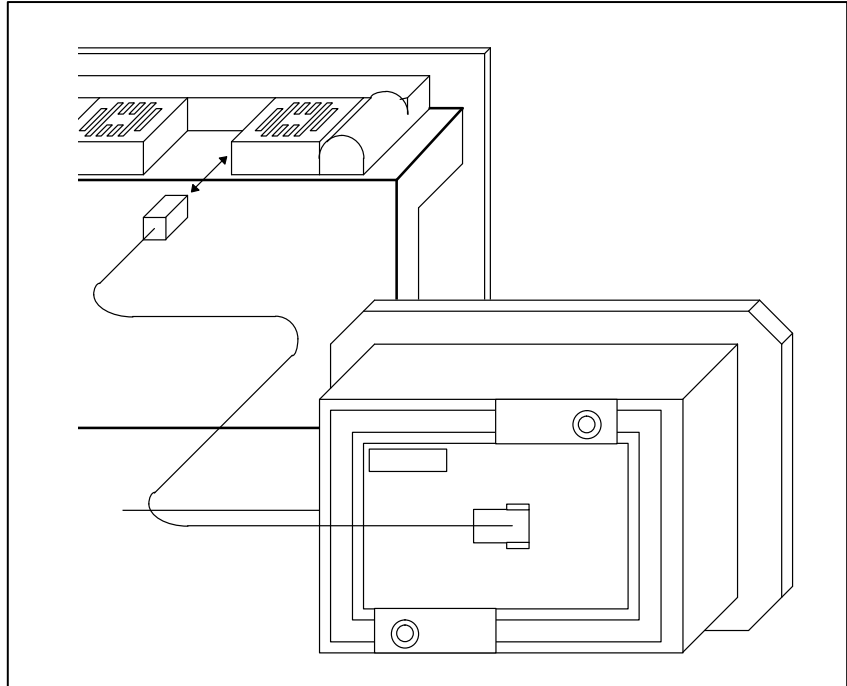
When replacing the dry cells while the power is off, use the same procedure as that for lithium battery replacement, described above.



## 1.2 USE OF ALKALINE DRY CELLS (SIZE D)

### Connection

Power from external batteries is supplied through the same connector as that to which the lithium battery is connected. The lithium battery, provided as standard, can be replaced with external batteries in a battery case (A02B-0236-C281) according to the battery replacement procedures described above.



#### NOTE

Install the battery case (A02B-0236-C281: 14-m cable) in a location where the batteries can be replaced even when the control unit power is on.

The battery cable connector is attached to the control unit by means of a simple lock system. To prevent the connector from being disconnected due to the weight or tension of the cable, secure the cable within 50 cm of the connector.

### 1.3 BATTERY FOR SEPARATE ABSOLUTE PULSE CODERS

One battery unit can maintain the current position data held in an absolute pulse coder for about one year.

When the battery voltage falls, APC alarms 306 to 308 are displayed on the screen. When APC alarm 307 is displayed, replace the battery as soon as possible. In general, the battery should be replaced within one or two weeks of the alarm first appearing. This, however, depends on the number of pulse coders being used.

If the battery voltage drops any further, the current positions for the pulse coders will be lost. Turning on the power to the control unit in this state results in APC alarm 300 (reference position return request alarm) being issued. Return the tool to the reference position after replacing the battery. See Subsection 7.9.2 for details of connecting the battery to separate absolute pulse coders. The battery for the built-in absolute pulse coder is installed in the servo amplifier. For an explanation of the replacement procedure, refer to the FANUC CONTROL MOTOR AMPLIFIER  $\alpha$  Series Maintenance Manual.

# **APPENDIX**

# A TAPE CODE LIST

| ISO code  |   |   |   |   |   |   |   |   | EIA code  |   |   |   |   |   |   |   |   | Meaning   |                               |                           |
|-----------|---|---|---|---|---|---|---|---|-----------|---|---|---|---|---|---|---|---|-----------|-------------------------------|---------------------------|
| Character | 8 | 7 | 6 | 5 | 4 | 3 | 2 | 1 | Character | 8 | 7 | 6 | 5 | 4 | 3 | 2 | 1 |           | Without<br>CUSTOM<br>MACURO B | With<br>CUSTOM<br>MACRO B |
| 0         |   |   | ○ | ○ |   | ○ |   |   | 0         |   |   | ○ |   |   | ○ |   |   | Number 0  |                               |                           |
| 1         | ○ |   | ○ | ○ |   | ○ |   | ○ | 1         |   |   |   |   |   | ○ |   | ○ | Number 1  |                               |                           |
| 2         | ○ |   | ○ | ○ |   | ○ |   | ○ | 2         |   |   |   |   |   | ○ |   | ○ | Number 2  |                               |                           |
| 3         |   |   | ○ | ○ |   | ○ |   | ○ | 3         |   |   | ○ |   |   | ○ |   | ○ | Number 3  |                               |                           |
| 4         | ○ |   | ○ | ○ |   | ○ |   | ○ | 4         |   |   |   |   |   | ○ |   | ○ | Number 4  |                               |                           |
| 5         |   |   | ○ | ○ |   | ○ |   | ○ | 5         |   |   |   |   |   | ○ |   | ○ | Number 5  |                               |                           |
| 6         |   |   | ○ | ○ |   | ○ |   | ○ | 6         |   |   | ○ |   |   | ○ |   | ○ | Number 6  |                               |                           |
| 7         | ○ |   | ○ | ○ |   | ○ |   | ○ | 7         |   |   |   |   |   | ○ |   | ○ | Number 7  |                               |                           |
| 8         | ○ |   | ○ | ○ |   | ○ |   |   | 8         |   |   |   |   |   | ○ |   |   | Number 8  |                               |                           |
| 9         |   |   | ○ | ○ |   | ○ |   | ○ | 9         |   |   | ○ |   |   | ○ |   | ○ | Number 9  |                               |                           |
| A         |   | ○ |   |   |   | ○ |   | ○ | a         |   | ○ | ○ |   |   | ○ |   | ○ | Address A |                               |                           |
| B         |   | ○ |   |   |   | ○ |   | ○ | b         |   | ○ | ○ |   |   | ○ |   | ○ | Address B |                               |                           |
| C         | ○ | ○ |   |   |   | ○ |   | ○ | c         |   | ○ | ○ | ○ |   | ○ |   | ○ | Address C |                               |                           |
| D         |   | ○ |   |   |   | ○ |   | ○ | d         |   | ○ | ○ |   |   | ○ |   | ○ | Address D |                               |                           |
| E         | ○ | ○ |   |   |   | ○ |   | ○ | e         |   | ○ | ○ | ○ |   | ○ |   | ○ | Address E |                               |                           |
| F         | ○ | ○ |   |   |   | ○ |   | ○ | f         |   | ○ | ○ | ○ |   | ○ |   | ○ | Address F |                               |                           |
| G         |   | ○ |   |   |   | ○ |   | ○ | g         |   | ○ | ○ |   |   | ○ |   | ○ | Address G |                               |                           |
| H         |   | ○ |   |   |   | ○ |   | ○ | h         |   | ○ | ○ |   |   | ○ |   |   | Address H |                               |                           |
| I         | ○ | ○ |   |   |   | ○ |   | ○ | i         |   | ○ | ○ | ○ |   | ○ |   | ○ | Address I |                               |                           |
| J         | ○ | ○ |   |   |   | ○ |   | ○ | j         |   | ○ | ○ |   |   | ○ |   | ○ | Address J |                               |                           |
| K         |   | ○ |   |   |   | ○ |   | ○ | k         |   | ○ | ○ |   |   | ○ |   | ○ | Address K |                               |                           |
| L         | ○ | ○ |   |   |   | ○ |   | ○ | l         |   | ○ |   |   |   | ○ |   | ○ | Address L |                               |                           |
| M         |   | ○ |   |   |   | ○ |   | ○ | m         |   | ○ | ○ |   |   | ○ |   |   | Address M |                               |                           |
| N         |   | ○ |   |   |   | ○ |   | ○ | n         |   | ○ |   |   |   | ○ |   | ○ | Address N |                               |                           |
| O         | ○ | ○ |   |   |   | ○ |   | ○ | o         |   | ○ |   |   |   | ○ |   | ○ | Address O |                               |                           |
| P         |   | ○ |   |   |   | ○ |   |   | p         |   | ○ | ○ |   |   | ○ |   | ○ | Address P |                               |                           |
| Q         | ○ | ○ |   |   |   | ○ |   |   | q         |   | ○ | ○ | ○ |   |   |   |   | Address Q |                               |                           |
| R         | ○ | ○ |   |   |   | ○ |   | ○ | r         |   | ○ |   |   |   | ○ |   | ○ | Address R |                               |                           |
| S         |   | ○ |   |   |   | ○ |   | ○ | s         |   |   | ○ | ○ |   | ○ |   | ○ | Address S |                               |                           |
| T         | ○ | ○ |   |   |   | ○ |   |   | t         |   |   | ○ |   |   | ○ |   | ○ | Address T |                               |                           |
| U         |   | ○ |   |   |   | ○ |   | ○ | u         |   |   | ○ | ○ |   | ○ |   |   | Address U |                               |                           |
| V         |   | ○ |   |   |   | ○ |   | ○ | v         |   |   | ○ |   |   | ○ |   | ○ | Address V |                               |                           |
| W         | ○ | ○ |   |   |   | ○ |   | ○ | w         |   |   | ○ |   |   | ○ |   | ○ | Address W |                               |                           |
| X         | ○ | ○ |   |   |   | ○ |   |   | x         |   |   | ○ | ○ |   | ○ |   | ○ | Address X |                               |                           |
| Y         |   | ○ |   |   |   | ○ |   | ○ | y         |   |   | ○ | ○ | ○ |   |   |   | Address Y |                               |                           |
| Z         |   | ○ |   |   |   | ○ |   | ○ | z         |   |   | ○ | ○ | ○ |   |   | ○ | Address Z |                               |                           |

| ISO code  |   |   |   |   |   |   |   |   | EIA code             |   |   |   |   |   |   |   |   | Meaning                |                     |
|-----------|---|---|---|---|---|---|---|---|----------------------|---|---|---|---|---|---|---|---|------------------------|---------------------|
| Character | 8 | 7 | 6 | 5 | 4 | 3 | 2 | 1 | Character            | 8 | 7 | 6 | 5 | 4 | 3 | 2 | 1 | Without CUSTOM MACRO B | With CUSTOM MACRO B |
| DEL       | ○ | ○ | ○ | ○ | ○ | ○ | ○ | ○ | Del                  |   | ○ | ○ | ○ | ○ | ○ | ○ | ○ | ×                      | ×                   |
| NUL       |   |   |   |   |   | ○ |   |   | Blank                |   |   |   |   |   | ○ |   |   | ×                      | ×                   |
| BS        | ○ |   |   |   | ○ | ○ |   |   | BS                   |   |   | ○ |   | ○ | ○ | ○ |   | ×                      | ×                   |
| HT        |   |   |   |   | ○ | ○ |   | ○ | Tab                  |   |   | ○ | ○ | ○ | ○ | ○ |   | ×                      | ×                   |
| LF or NL  |   |   |   |   | ○ | ○ |   | ○ | CR or EOB            | ○ |   |   |   |   | ○ |   |   |                        |                     |
| CR        | ○ |   |   |   | ○ | ○ | ○ | ○ | —                    |   |   |   |   |   |   |   |   | ×                      | ×                   |
| SP        | ○ | ○ |   |   | ○ |   |   |   | SP                   |   |   | ○ | ○ |   |   |   |   | □                      | □                   |
| %         | ○ | ○ |   |   | ○ | ○ |   | ○ | ER                   |   |   |   | ○ | ○ |   | ○ | ○ |                        |                     |
| (         |   |   | ○ |   | ○ | ○ |   |   | (2-4-5)              |   |   |   | ○ | ○ | ○ | ○ |   |                        |                     |
| )         | ○ | ○ |   |   | ○ | ○ |   | ○ | (2-4-7)              | ○ |   |   | ○ | ○ |   | ○ |   |                        |                     |
| +         |   |   | ○ |   | ○ | ○ |   | ○ | +                    | ○ | ○ | ○ |   | ○ |   |   |   | △                      |                     |
| -         |   |   | ○ |   | ○ | ○ |   | ○ | -                    | ○ |   |   |   | ○ |   |   |   |                        |                     |
| :         |   |   | ○ | ○ | ○ | ○ |   | ○ | —                    |   |   |   |   |   |   |   |   |                        |                     |
| /         | ○ | ○ |   |   | ○ | ○ | ○ | ○ | /                    |   |   | ○ | ○ |   | ○ |   | ○ |                        |                     |
| .         |   |   | ○ |   | ○ | ○ | ○ | ○ | .                    | ○ | ○ |   | ○ | ○ |   | ○ | ○ |                        |                     |
| #         | ○ | ○ |   |   | ○ |   |   | ○ | Parameter (No. 6012) |   |   |   |   |   |   |   |   |                        |                     |
| \$        |   |   | ○ |   | ○ | ○ |   |   | —                    |   |   |   |   |   |   |   |   | △                      | ○                   |
| &         | ○ | ○ |   |   | ○ | ○ | ○ |   | &                    |   |   |   | ○ | ○ | ○ | ○ |   | △                      | ○                   |
| ▽         |   |   | ○ |   | ○ | ○ | ○ | ○ | —                    |   |   |   |   |   |   |   |   | △                      | ○                   |
| *         | ○ | ○ |   |   | ○ | ○ |   | ○ | Parameter (No. 6010) |   |   |   |   |   |   |   |   | △                      |                     |
| ,         | ○ | ○ |   |   | ○ | ○ | ○ |   | ,                    |   |   | ○ | ○ | ○ | ○ | ○ |   |                        |                     |
| ;         | ○ | ○ | ○ | ○ | ○ | ○ |   | ○ | —                    |   |   |   |   |   |   |   |   | △                      | △                   |
| <         |   |   | ○ | ○ | ○ | ○ |   | ○ | —                    |   |   |   |   |   |   |   |   | △                      | △                   |
| =         | ○ | ○ | ○ | ○ | ○ | ○ |   | ○ | Parameter (No. 6011) |   |   |   |   |   |   |   |   | △                      |                     |
| >         | ○ | ○ | ○ | ○ | ○ | ○ |   | ○ | —                    |   |   |   |   |   |   |   |   | △                      | △                   |
| ?         |   |   | ○ | ○ | ○ | ○ | ○ | ○ | —                    |   |   |   |   |   |   |   |   | △                      | ○                   |
| @         | ○ | ○ |   |   | ○ |   |   |   | —                    |   |   |   |   |   |   |   |   | △                      | ○                   |
| "         |   |   | ○ |   |   |   |   | ○ | —                    |   |   |   |   |   |   |   |   | △                      | △                   |
| [         | ○ | ○ |   |   | ○ | ○ |   | ○ | Parameter (No. 6013) |   |   |   |   |   |   |   |   | △                      |                     |
| ]         | ○ | ○ |   |   | ○ | ○ |   | ○ | Parameter (No. 6014) |   |   |   |   |   |   |   |   | △                      |                     |

**NOTE**

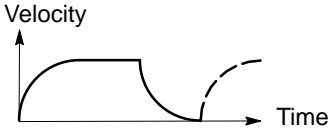
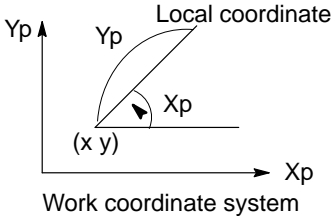
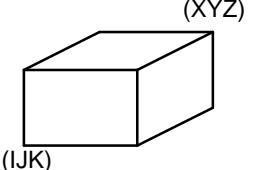

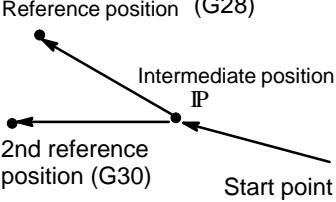
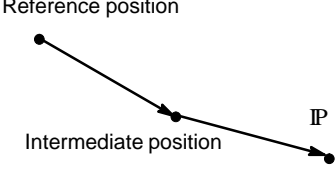
- 1 The symbols used in the remark column have the following meanings.
  - (Space) : The character will be registered in memory and has a specific meaning. It it is used incorrectly in a statement other than a comment, an alarm occurs.
  - × : The character will not be registered in memory and will be ignored.
  - Δ : The character will be registered in memory, but will be ignored during program execution.
  - : The character will be registered in memory. If it is used in a statement other than a comment, an alarm occurs.
  - : If it is used in a statement other than a comment, the character will not be registered in memory. If it is used in a comment, it will be registered in memory.
- 2 Codes not in this table are ignored if their parity is correct.
- 3 Codes with incorrect parity cause the TH alarm. But they are ignored without generating the TH alarm when they are in the comment section.
- 4 A character with all eight holes punched is ignored and does not generate TH alarm in EIA code.

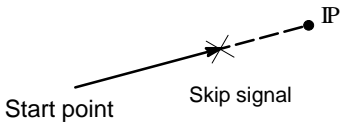
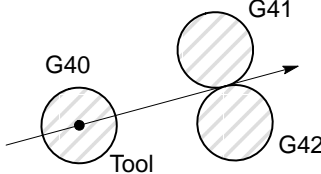
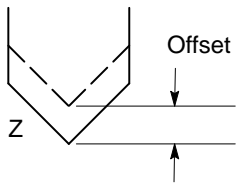
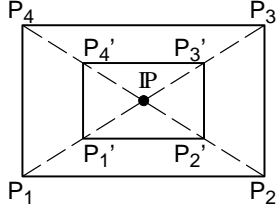
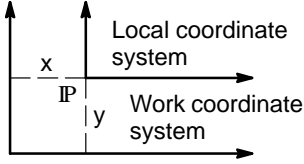


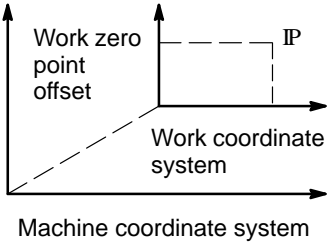
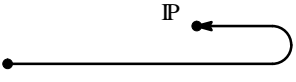
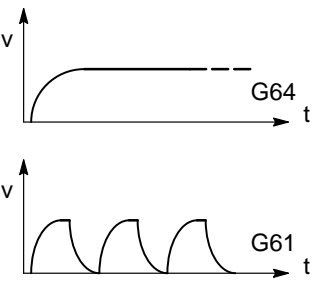
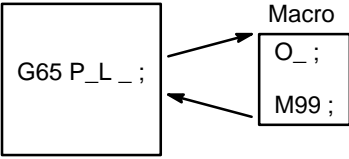
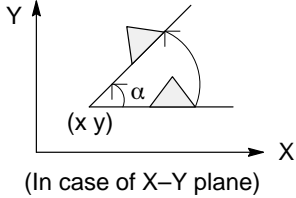
# B LIST OF FUNCTIONS AND TAPE FORMAT

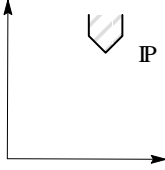
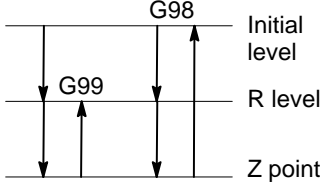
Some functions cannot be added as options depending on the model.  
 In the tables below, IP \_\_; presents a combination of arbitrary axis addresses using X,Y,Z,A,B and C (such as X\_Y\_Z\_A\_).  
 x = 1st basic axis (X usually)  
 y = 2nd basic axis (Y usually)  
 z = 3rd basic axis (Z usually)

| Functions                         | Illustration                  | Tape format                                                                                                                                                                                                                                                                                                                                                                                                                   |
|-----------------------------------|-------------------------------|-------------------------------------------------------------------------------------------------------------------------------------------------------------------------------------------------------------------------------------------------------------------------------------------------------------------------------------------------------------------------------------------------------------------------------|
| Positioning (G00)                 |                               | G00 IP_;                                                                                                                                                                                                                                                                                                                                                                                                                      |
| Linear interpolation (G01)        |                               | G01 IP_ F_;                                                                                                                                                                                                                                                                                                                                                                                                                   |
| Circular interpolation (G02, G03) |                               | $G17 \begin{Bmatrix} G02 \\ G03 \end{Bmatrix} X\_Y\_ \begin{Bmatrix} R\_ \\ I\_J\_ \end{Bmatrix} F\_;$ $G18 \begin{Bmatrix} G02 \\ G03 \end{Bmatrix} X\_Z\_ \begin{Bmatrix} R\_ \\ I\_K\_ \end{Bmatrix} F\_;$ $G19 \begin{Bmatrix} G02 \\ G03 \end{Bmatrix} Y\_Z\_ \begin{Bmatrix} R\_ \\ J\_K\_ \end{Bmatrix} F\_;$                                                                                                          |
| Helical interpolation (G02, G03)  | <p>(In case of X-Y plane)</p> | $G17 \begin{Bmatrix} G02 \\ G03 \end{Bmatrix} X\_Y\_ \begin{Bmatrix} R\_ \\ I\_J\_ \end{Bmatrix} \alpha\_ F\_;$ $G18 \begin{Bmatrix} G02 \\ G03 \end{Bmatrix} X\_Z\_ \begin{Bmatrix} R\_ \\ I\_K\_ \end{Bmatrix} \alpha\_ F\_;$ $G19 \begin{Bmatrix} G02 \\ G03 \end{Bmatrix} Y\_Z\_ \begin{Bmatrix} R\_ \\ J\_K\_ \end{Bmatrix} \alpha\_ F\_;$ <p><math>\alpha</math> : Any axis other than circular interpolation axes.</p> |

| Functions                                                               | Illustration                                                                                                                                                                                      | Tape format                                                                             |
|-------------------------------------------------------------------------|---------------------------------------------------------------------------------------------------------------------------------------------------------------------------------------------------|-----------------------------------------------------------------------------------------|
| Dwell (G04)                                                             |                                                                                                                                                                                                   | G04 { X_ } ;<br>P_ }                                                                    |
| Look-ahead control (G08)                                                |                                                                                                                                                                                                   | G08 P1:<br>Look-ahead control mode on<br>G08 P0:<br>Look-ahead control mode off         |
| Exact stop (G09)                                                        |  <p>Velocity<br/>Time</p>                                                                                        | G09 { G01 } IP_ ;<br>G02 }<br>G03 }                                                     |
| Change of offset value by program (G10)                                 |                                                                                                                                                                                                   | G10 L11 P_R_ ;<br>G10 L1 P_R_ ;                                                         |
| Polar coordinate (G15, G16)                                             |  <p>Yp<br/>Local coordinate<br/>Xp<br/>(x y)<br/>Work coordinate system</p>                                      | G17 G16 Xp_ Yp_ ... ;<br>G18 G16 Zp_ Xp_ ... ;<br>G19 G16 Yp_ Zp_ ... ;<br>G15 ; Cancel |
| Plane section (G17, G18, G19)                                           |                                                                                                                                                                                                   | G17 ;<br>G18 ;<br>G19 ;                                                                 |
| Inch/millimeter conversion (G20, G21)                                   |                                                                                                                                                                                                   | G20 ; Inch input<br>G21 ; Millimeter input                                              |
| Stored stroke check (G22, G23)                                          |  <p>(XYZ)<br/>(IJK)</p>                                                                                        | G22 X_Y_Z_I_J_K_ ;<br>G23 Cancel;                                                       |
| Reference position return check (G27)                                   |  <p>Start point<br/>IP</p>                                                                                     | G27 IP_ ;                                                                               |
| Reference position return (G28)<br>2nd, reference position return (G30) |  <p>Reference position (G28)<br/>Intermediate position IP<br/>2nd reference position (G30)<br/>Start point</p> | G28 IP_ ;<br>G30 IP_ ;                                                                  |
| Return from reference position to start point (G29)                     |  <p>Reference position<br/>Intermediate position<br/>IP</p>                                                    | G29 IP_ ;                                                                               |

| Functions                                  | Illustration                                                                        | Tape format                                                                                                                                                                                                                                                                                                                                                   |
|--------------------------------------------|-------------------------------------------------------------------------------------|---------------------------------------------------------------------------------------------------------------------------------------------------------------------------------------------------------------------------------------------------------------------------------------------------------------------------------------------------------------|
| Skip function (G31)                        |    | G31 IP_ F_;                                                                                                                                                                                                                                                                                                                                                   |
| Cutter compensation C (G40 – G42)          |    | $\left\{ \begin{matrix} G17 \\ G18 \\ G19 \end{matrix} \right\} \left\{ \begin{matrix} G41 \\ G42 \end{matrix} \right\} D_;$ <p>D : Tool offset<br/>G40 : Cancel</p>                                                                                                                                                                                          |
| Tool length offset A (G43, G44, G49)       |    | $\left\{ \begin{matrix} G43 \\ G44 \end{matrix} \right\} Z_ H_;$ $\left\{ \begin{matrix} G43 \\ G44 \end{matrix} \right\} H_;$ <p>H : Tool offset<br/>G49 : Cancel</p>                                                                                                                                                                                        |
| Tool length offset B (G43, G44, G49)       |                                                                                     | $\left\{ \begin{matrix} G17 \\ G18 \\ G19 \end{matrix} \right\} \left\{ \begin{matrix} G43 \\ G44 \end{matrix} \right\} \left\{ \begin{matrix} Z_ \\ Y_ \\ X_ \end{matrix} \right\} H_;$ $\left\{ \begin{matrix} G17 \\ G18 \\ G19 \end{matrix} \right\} \left\{ \begin{matrix} G43 \\ G44 \end{matrix} \right\} H_;$ <p>H : Tool offset<br/>G49 : Cancel</p> |
| Scaling (G50, G51)                         |  | G51 IP_ P_;                                                                                                                                                                                                                                                                                                                                                   |
| Setting of local coordinate system (G52)   |  | G52 IP_ ;                                                                                                                                                                                                                                                                                                                                                     |
| Command in machine coordinate system (G53) |                                                                                     | G53 IP_ ;                                                                                                                                                                                                                                                                                                                                                     |

| Functions                                                             | Illustration                                                                                                      | Tape format                                                                                                                                                         |
|-----------------------------------------------------------------------|-------------------------------------------------------------------------------------------------------------------|---------------------------------------------------------------------------------------------------------------------------------------------------------------------|
| Selection of work coordinate system (G54 – G59)                       |                                  | $\left. \begin{matrix} G54 \\ : \\ G59 \end{matrix} \right\} IP_;$                                                                                                  |
| Single direction positioning (G60)                                    |                                  | G60 IP_ ;                                                                                                                                                           |
| Cutting mode/Exact stop mode, Tapping mode, Automatic corner override |                                  | G64_ ; Cutting mode<br>G61_ ; Exact stop mode<br>G63_ ; Tapping mode<br>G62_ ; Automatic corner override                                                            |
| Custom macro (G65, G66, G67)                                          |                                 | One-shot call<br>G65 P_ L_ <Argument assignment> ;<br>P : Program No.<br>L : Number of repetition<br>Modal call<br>G66 P_ L_ <Argument assignment>;<br>G67 ; Cancel |
| Coordinate system rotation (G68, G69)                                 |  <p>(In case of X-Y plane)</p> | $G68 \left\{ \begin{matrix} G17 X_ Y_ \\ G18 Z_ X_ \\ G19 Y_ Z_ \end{matrix} \right\} R \alpha ;$ G69 ; Cancel                                                      |
| Canned cycles (G73, G74, G80 – G89)                                   | Refer to II.14. FUNCTIONS TO SIMPLIFY PROGRAMMING                                                                 | G80 ; Cancel<br>$\left. \begin{matrix} G73 \\ G74 \\ G76 \\ G81 \\ : \\ G89 \end{matrix} \right\} X_ Y_ Z_ P_ Q_ R_ F_ K_ ;$                                        |

| Functions                                        | Illustration                                                                         | Tape format                                                                       |
|--------------------------------------------------|--------------------------------------------------------------------------------------|-----------------------------------------------------------------------------------|
| Absolute/incremental programming (G90/G91)       |                                                                                      | G90_ ; Absolute command<br>G91_ ; Incremental command<br>G90_ G91_ ; Combined use |
| Change of workpiece coordinate system (G92)      |     | G92 IP_ ;                                                                         |
| Workpiece coordinate system preset (G92.1)       |                                                                                      | G92.1 IP 0;                                                                       |
| Feed per minute, Feed per revolution (G94, G95)  | mm/min    inch/min<br>mm/rev    inch/rev                                             | G98 F_ ;<br>G99 F_ ;                                                              |
| Constant surface speed control (G96, G97)        |                                                                                      | G96 S_ ;<br>G97 S_ ;                                                              |
| Initial point return / R point return (G98, G99) |  | G98_ ;<br>G99_ ;                                                                  |

# C RANGE OF COMMAND VALUE

## Linear axis

- In case of millimeter input, feed screw is millimeter

|                                 | Increment system            |                                  |
|---------------------------------|-----------------------------|----------------------------------|
|                                 | IS-B                        | IS-C                             |
| Least input increment           | 0.001 mm                    | 0.0001 mm                        |
| Least command increment         | 0.001 mm                    | 0.0001 mm                        |
| Max. programmable dimension     | ±99999.999 mm               | ±9999.9999 mm                    |
| Max. rapid traverse <b>Note</b> | 240000 mm/min               | 100000 mm/min                    |
| Feedrate range <b>Note</b>      | 1 to 240000 mm/min          | 1 to 100000 mm/min               |
| Incremental feed                | 0.001, 0.01, 0.1, 1 mm/step | 0.0001, 0.001, 0.01, 0.1 mm/step |
| Tool compensation               | 0 to ±999.999 mm            | 0 to ±999.9999 mm                |
| Dwell time                      | 0 to 99999.999 sec          | 0 to 99999.999 sec               |

- In case of inch input, feed screw is millimeter

|                                 | Increment system                   |                                        |
|---------------------------------|------------------------------------|----------------------------------------|
|                                 | IS-B                               | IS-C                                   |
| Least input increment           | 0.0001 inch                        | 0.00001 inch                           |
| Least command increment         | 0.001 mm                           | 0.0001 mm                              |
| Max. programmable dimension     | ±9999.9999 inch                    | ±393.70078 inch                        |
| Max. rapid traverse <b>Note</b> | 240000 mm/min                      | 100000 mm/min                          |
| Feedrate range <b>Note</b>      | 0.01 to 9600 inch/min              | 0.01 to 4000 inch/min                  |
| Incremental feed                | 0.0001, 0.001, 0.01, 0.1 inch/step | 0.00001, 0.0001, 0.001, 0.01 inch/step |
| Tool compensation               | 0 to ±99.9999 inch                 | 0 to ±99.9999 inch                     |
| Dwell time                      | 0 to 99999.999 sec                 | 0 to 9999.9999 sec                     |

- In case of inch input, feed screw is inch

|                                 | Increment system                   |                                        |
|---------------------------------|------------------------------------|----------------------------------------|
|                                 | IS-B                               | IS-C                                   |
| Least input increment           | 0.0001 inch                        | 0.00001 inch                           |
| Least command increment         | 0.0001 inch                        | 0.00001 inch                           |
| Max. programmable dimension     | ±9999.9999 inch                    | ±9999.9999 inch                        |
| Max. rapid traverse <b>Note</b> | 9600 inch/min                      | 4000 inch/min                          |
| Feedrate range <b>Note</b>      | 0.01 to 9600 inch/min              | 0.01 to 4000 inch/min                  |
| Incremental feed                | 0.0001, 0.001, 0.01, 0.1 inch/step | 0.00001, 0.0001, 0.001, 0.01 inch/step |
| Tool compensation               | 0 to ±99.9999 inch                 | 0 to ±99.9999 inch                     |
| Dwell time                      | 0 to 99999.999 sec                 | 0 to 9999.9999 sec                     |

- In case of millimeter input, feed screw is inch

|                                 | Increment system            |                                  |
|---------------------------------|-----------------------------|----------------------------------|
|                                 | IS-B                        | IS-C                             |
| Least input increment           | 0.001 mm                    | 0.0001 mm                        |
| Least command increment         | 0.0001 inch                 | 0.00001 inch                     |
| Max. programmable dimension     | ±99999.999 mm               | ±9999.9999 mm                    |
| Max. rapid traverse <b>Note</b> | 9600 inch/min               | 4000 inch/min                    |
| Feedrate range <b>Note</b>      | 1 to 240000 mm/min          | 1 to 100000 mm/min               |
| Incremental feed                | 0.001, 0.01, 0.1, 1 mm/step | 0.0001, 0.001, 0.01, 0.1 mm/step |
| Tool compensation               | 0 to ±999.999 mm            | 0 to ±999.9999 mm                |
| Dwell time                      | 0 to 99999.999 sec          | 0 to 9999.9999 sec               |

**Rotation axis**

|                                 | Increment system                |                                      |
|---------------------------------|---------------------------------|--------------------------------------|
|                                 | IS-B                            | IS-C                                 |
| Least input increment           | 0.001 deg                       | 0.0001 deg                           |
| Least command increment         | 0.001 deg                       | 0.0001 deg                           |
| Max. programmable dimension     | ±99999.999 deg                  | ±9999.9999 deg                       |
| Max. rapid traverse <b>Note</b> | 240000 deg/min                  | 100000 deg/min                       |
| Feedrate range <b>Note</b>      | 1 to 240000 deg/min             | 1 to 100000 deg/min                  |
| Incremental feed                | 0.001, 0.01, 0.1,<br>1 deg/step | 0.0001, 0.001, 0.01,<br>0.1 deg/step |

**NOTE**

The feedrate range shown above are limitations depending on CNC interpolation capacity. As a whole system, limitations depending on servo system must also be considered.



# D NOMOGRAPHS



# D.1 INCORRECT THREADED LENGTH

The leads of a thread are generally incorrect in  $\delta_1$  and  $\delta_2$ , as shown in Fig. D.1 (a), due to automatic acceleration and deceleration. Thus distance allowances must be made to the extent of  $\delta_1$  and  $\delta_2$  in the program.

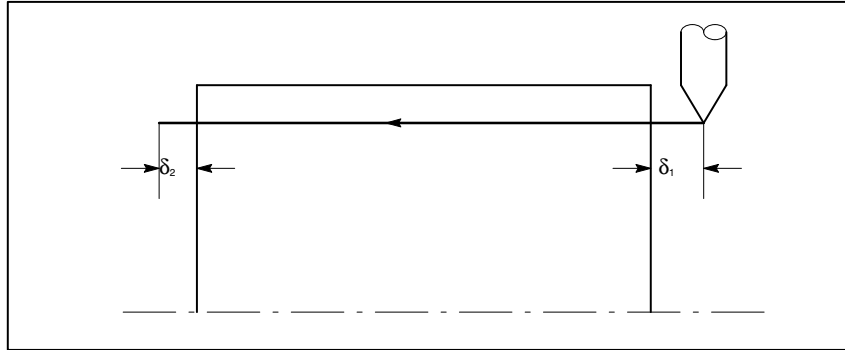


Fig.D.1(a) Incorrect thread position

## Explanations

- How to determine  $\delta_2$

$$\delta_2 = T_1 V \text{ (mm) } \dots\dots\dots (1)$$

$$V = \frac{1}{60} RL$$

$T_1$  : Time constant of servo system (sec)  
 $V$  : Cutting speed (mm/sec)  
 $R$  : Spindle speed (rpm)  
 $L$  : Thread feed (mm)

Time constant  $T_1$  (sec) of the servo system: Usually 0.033 s.

- How to determine  $\delta_1$

$$\delta_1 = \{t - T_1 + T_1 \exp(-\frac{t}{T_1})\} V \dots\dots\dots (2)$$

$$a = \exp(-\frac{t}{T_1}) \dots\dots\dots (3)$$

$T_1$  : Time constant of servo system (sec)  
 $V$  : Cutting speed (mm/sec)

Time constant  $T_1$  (sec) of the servo system: Usually 0.033 s.

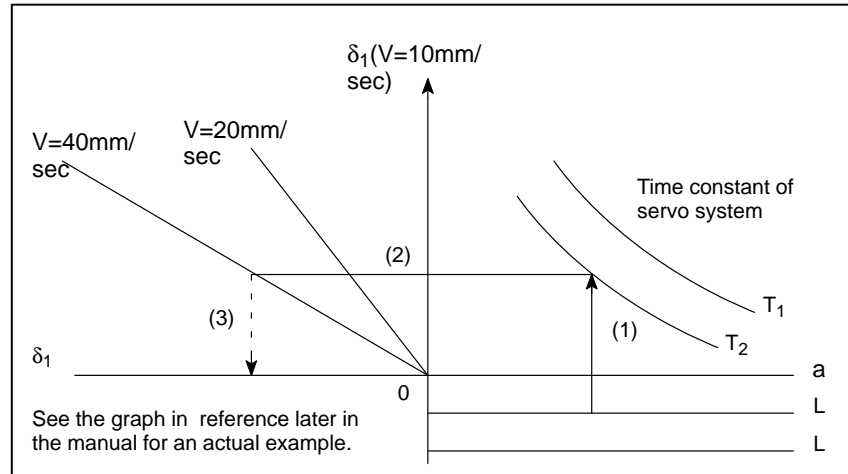
The lead at the beginning of thread cutting is shorter than the specified lead  $L$ , and the allowable lead error is  $\Delta L$ . Then as follows.

$$a = \frac{\Delta L}{L}$$

When the value of  $H\alpha I$  is determined, the time lapse until the thread accuracy is attained. The time  $HtI$  is substituted in (2) to determine  $\delta_1$ : Constants  $V$  and  $T_1$  are determined in the same way as for  $\delta_2$ . Since the calculation of  $\delta_1$  is rather complex, a nomography is provided on the following pages.

• **How to use nomograph**

First specify the class and the lead of a thread. The thread accuracy,  $\alpha$ , will be obtained at (1), and depending on the time constant of cutting feed acceleration/ deceleration, the  $\delta_1$  value when  $V = 10\text{mm} / \text{s}$  will be obtained at (2). Then, depending on the speed of thread cutting,  $\delta_1$  for speed other than  $10\text{mm}/\text{s}$  can be obtained at (3).



**Fig.D.1(b) Nomograph**

**NOTE**

The equations for  $\delta_1$ , and  $\delta_2$  are for when the acceleration/ deceleration time constant for cutting feed is 0.

## D.2 SIMPLE CALCULATION OF INCORRECT THREAD LENGTH

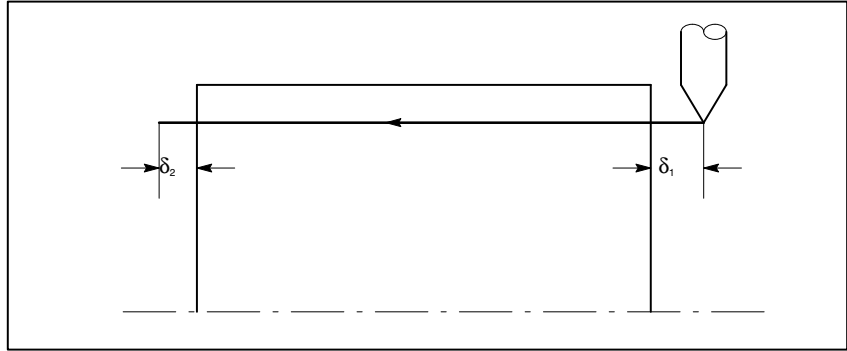


Fig. D.2 (a) Incorrect threaded portion

### Explanations

- How to determine  $\delta_2$

$$\delta_2 = \frac{LR}{1800^*} \text{ (mm)}$$

R : Spindle speed (rpm)  
L : Thread lead (mm)

\* When time constant T of the servo system is 0.033 s.

- How to determine  $\delta_1$

$$\begin{aligned} \delta_1 &= \frac{LR}{1800^*}(-1-\ln a) \text{ (mm)} \\ &= \delta_2(-1-\ln a) \text{ (mm)} \end{aligned}$$

R : Spindle speed (rpm)  
L : Thread lead (mm)

\* When time constant T of the servo system is 0.033 s.

Following a is a permitted value of thread.

| a     | -1-lna |
|-------|--------|
| 0.005 | 4.298  |
| 0.01  | 3.605  |
| 0.015 | 3.200  |
| 0.02  | 2.912  |

### Examples

R=350rpm

L=1mm

a=0.01 then

$$\delta_2 = \frac{350 \times 1}{1800} = 0.194 \text{ (mm)}$$

$$\delta_1 = \delta_2 \times 3.605 = 0.701 \text{ (mm)}$$

● Reference

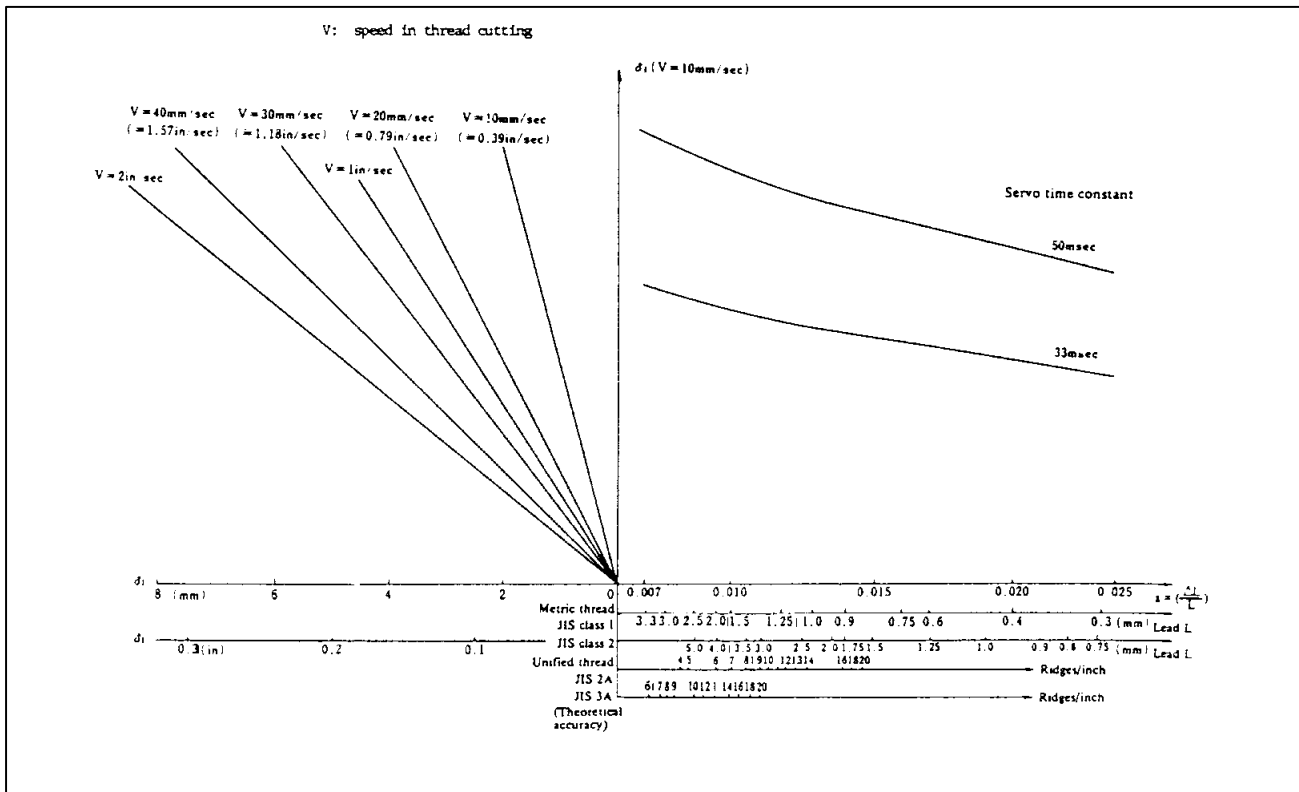
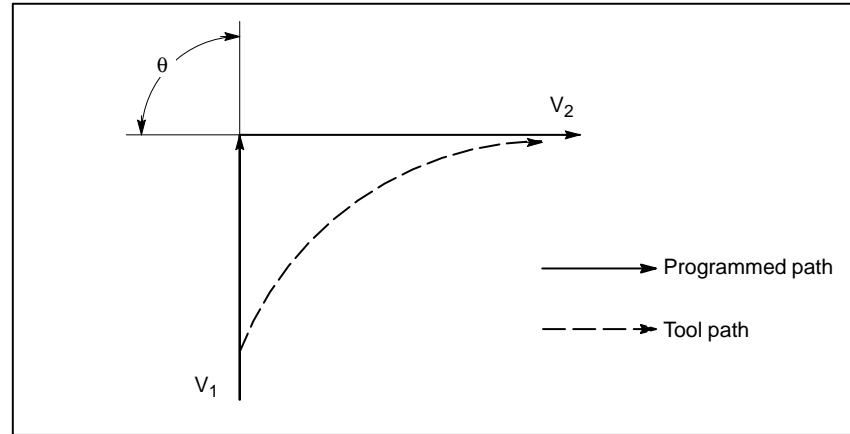


Fig D.2 (b) Nomograph for obtaining approach distance  $\delta_1$

### D.3 TOOL PATH AT CORNER

When servo system delay (by exponential acceleration/deceleration at cutting or caused by the positioning system when a servo motor is used) is accompanied by cornering, a slight deviation is produced between the tool path (tool center path) and the programmed path as shown in Fig. D.3 (a).

Time constant  $T_1$  of the exponential acceleration/deceleration is fixed to 0.



**Fig. D.3 (a) Slight deviation between the tool path and the programmed path**

This tool path is determined by the following parameters:

- **Feedrate ( $V_1, V_2$ )**
- **Corner angle ( $\theta$ )**
- **Exponential acceleration / deceleration time constant ( $T_1$ ) at cutting ( $T_1 = 0$ )**
- **Presence or absence of buffer register.**

The above parameters are used to theoretically analyze the tool path and above tool path is drawn with the parameter which is set as an example. When actually programming, the above items must be considered and programming must be performed carefully so that the shape of the workpiece is within the desired precision.

In other words, when the shape of the workpiece is not within the theoretical precision, the commands of the next block must not be read until the specified feedrate becomes zero. The dwell function is then used to stop the machine for the appropriate period.

## Analysis

The tool path shown in Fig. D.3 (b) is analyzed based on the following conditions:

Feedrate is constant at both blocks before and after cornering.

The controller has a buffer register. (The error differs with the reading speed of the tape reader, number of characters of the next block, etc.)

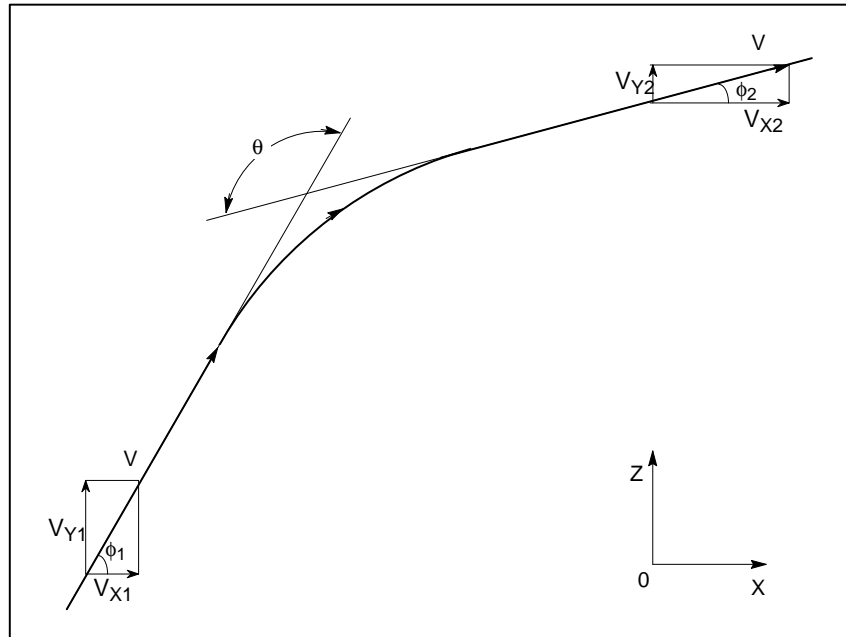


Fig. D.3(b) Example of tool path

- Description of conditions and symbols

$$V_{X1} = V \cos \phi_1$$

$$V_{Y1} = V \sin \phi_1$$

$$V_{X2} = V \cos \phi_2$$

$$V_{Y2} = V \sin \phi_2$$

$V$  : Feedrate at both blocks before and after cornering

$V_{X1}$  : X-axis component of feedrate of preceding block

$V_{Y1}$  : Y-axis component of feedrate of preceding block

$V_{X2}$  : X-axis component of feedrate of following block

$V_{Y2}$  : Y-axis component of feedrate of following block

$\theta$  : Corner angle

$\phi_1$  : Angle formed by specified path direction of preceding block and X-axis

$\phi_2$  : Angle formed by specified path direction of following block and X-axis

- Initial value calculation

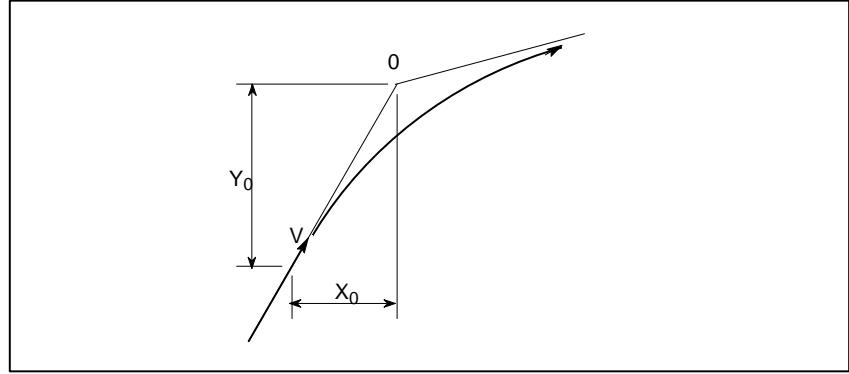


Fig. D.3(c) Initial value

The initial value when cornering begins, that is, the X and Y coordinates at the end of command distribution by the controller, is determined by the feedrate and the positioning system time constant of the servo motor.

$$X_0 = V_{x1}(T_1 + T_2)$$

$$Y_0 = V_{y1}(T_1 + T_2)$$

$T_1$ : Exponential acceleration / deceleration time constant. ( $T=0$ )

$T_2$ : Time constant of positioning system (Inverse of position loop gain)

- Analysis of corner tool path

The equations below represent the feedrate for the corner section in X-axis direction and Y-axis direction.

$$\begin{aligned} V_x(t) &= (V_{x2} - V_{x1}) \left[ 1 - \frac{V_{x1}}{T_1 - T_2} \left\{ T_1 \exp\left(-\frac{t}{T_1}\right) - T_2 \exp\left(-\frac{t}{T_2}\right) \right\} \right] + V_{x1} \\ &= V_{x2} \left[ 1 - \frac{V_{x1}}{T_1 - T_2} \left\{ T_1 \exp\left(-\frac{t}{T_1}\right) - T_2 \exp\left(-\frac{t}{T_2}\right) \right\} \right] \end{aligned}$$

$$V_y(t) = \frac{V_{y1} - V_{y2}}{T_1 - T_2} \left\{ T_1 \exp\left(-\frac{t}{T_1}\right) - T_2 \exp\left(-\frac{t}{T_2}\right) \right\} + V_{y2}$$

Therefore, the coordinates of the tool path at time  $t$  are calculated from the following equations:

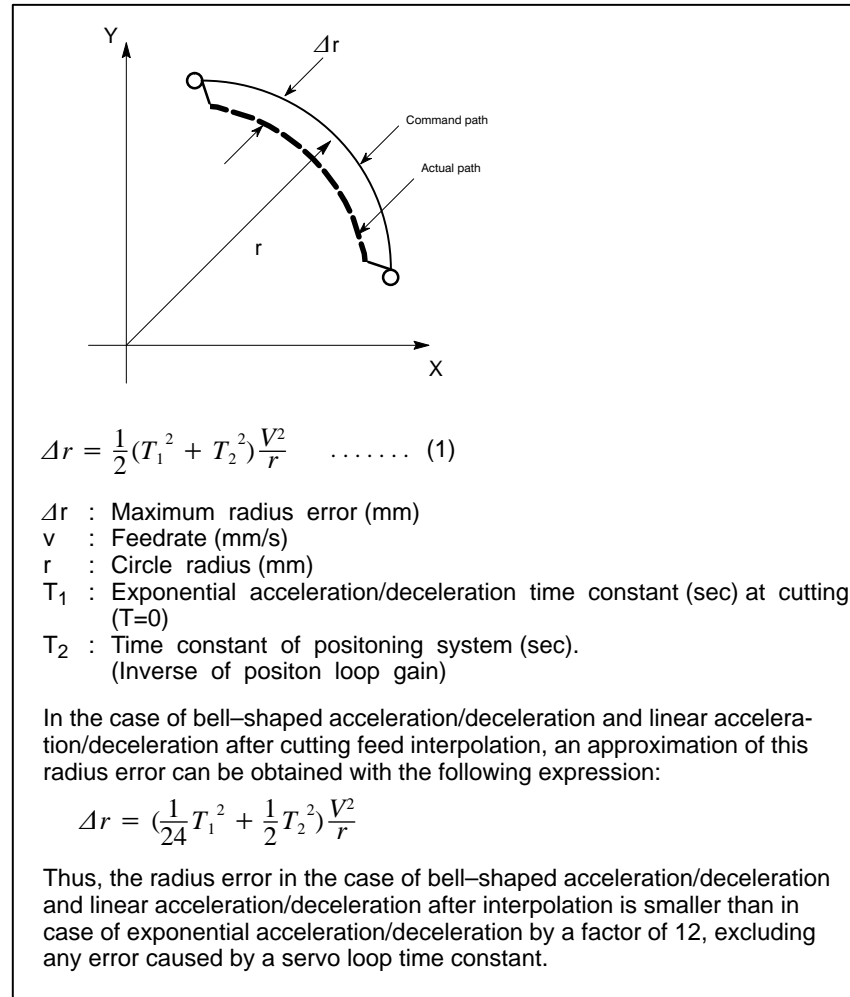
$$\begin{aligned} X(t) &= \int_0^t V_x(t) dt - X_0 \\ &= \frac{V_{x2} - V_{x1}}{T_1 - T_2} \left\{ T_1^2 \exp\left(-\frac{t}{T_1}\right) - T_2^2 \exp\left(-\frac{t}{T_2}\right) \right\} - V_{x2}(T_1 + T_2 - t) \\ Y(t) &= \int_0^t V_y(t) dt - Y_0 \\ &= \frac{V_{y2} - V_{y1}}{T_1 - T_2} \left\{ T_1^2 \exp\left(-\frac{t}{T_1}\right) - T_2^2 \exp\left(-\frac{t}{T_2}\right) \right\} - V_{y2}(T_1 + T_2 - t) \end{aligned}$$



## D.4 RADIUS DIRECTION ERROR AT CIRCLE CUTTING

When a servo motor is used, the positioning system causes an error between input commands and output results. Since the tool advances along the specified segment, an error is not produced in linear interpolation. In circular interpolation, however, radial errors may be produced, sepecially for circular cutting at high speeds.

This error can be obtained as follows:



Since the machining radius  $r$  (mm) and allowable error  $\Delta r$  (mm) of the workpiece is given in actual machining, the allowable limit feedrate  $v$  (mm/sec) is determined by equation (1).

Since the acceleration/deceleration time constant at cutting which is set by this equipment varies with the machine tool, refer to the manual issued by the machine tool builder.

# E STATUS WHEN TURNING POWER ON, WHEN CLEAR AND WHEN RESET

Parameter CLR (No. 3402#6) is used to select whether resetting the CNC places it in the cleared state or in the reset state (0: reset state/1: cleared state).

The symbols in the tables below mean the following :

○:The status is not changed or the movement is continued.

×:The status is cancelled or the movement is interrupted.

| Item                  |                                       | When turning power on                                                                                                 | Cleared                                        | Reset                          |
|-----------------------|---------------------------------------|-----------------------------------------------------------------------------------------------------------------------|------------------------------------------------|--------------------------------|
| Setting data          | Offset value                          | ○                                                                                                                     | ○                                              | ○                              |
|                       | Data set by the MDI setting operation | ○                                                                                                                     | ○                                              | ○                              |
|                       | Parameter                             | ○                                                                                                                     | ○                                              | ○                              |
| Various data          | Programs in memory                    | ○                                                                                                                     | ○                                              | ○                              |
|                       | Contents in the buffer storage        | ×                                                                                                                     | ×                                              | ○ : MDI mode<br>× : Other mode |
|                       | Display of sequence number            | ○                                                                                                                     | ○ (Note 1)                                     | ○ (Note 1)                     |
|                       | One shot G code                       | ×                                                                                                                     | ×                                              | ×                              |
|                       | Modal G code                          | Initial G codes.<br>(The G20 and G21 codes return to the same state they were in when the power was last turned off.) | Initial G codes.<br>(G20/G21 are not changed.) | ○                              |
|                       | F                                     | Zero                                                                                                                  | Zero                                           | ○                              |
|                       | S, T, M                               | ×                                                                                                                     | ○                                              | ○                              |
| K (Number of repeats) | ×                                     | ×                                                                                                                     | ×                                              |                                |
| Work coordinate value |                                       | Zero                                                                                                                  | ○                                              | ○                              |

| Item                |                                             | When turning power on                         | Cleared                                       | Reset                                                           |
|---------------------|---------------------------------------------|-----------------------------------------------|-----------------------------------------------|-----------------------------------------------------------------|
| Action in operation | Movement                                    | ×                                             | ×                                             | ×                                                               |
|                     | Dwell                                       | ×                                             | ×                                             | ×                                                               |
|                     | Issuance of M, S and T codes                | ×                                             | ×                                             | ×                                                               |
|                     | Tool length compensation                    | ×                                             | Depending on parameter LVK(No.5003#6)         | ○ : MDI mode<br>Other modes depend on parameter LVK(No.5003#6). |
|                     | Cutter compensation                         | ×                                             | ×                                             | ○ : MDI mode<br>× : Other modes                                 |
|                     | Storing called subprogram number            | ×                                             | × (Note 2)                                    | ○ : MDI mode<br>× : Other modes (Note 2)                        |
| Output signals      | CNC alarm signal AL                         | Extinguish if there is no cause for the alarm | Extinguish if there is no cause for the alarm | Extinguish if there is no cause for the alarm                   |
|                     | Reference position return completion LED    | ×                                             | ○<br>(× : Emergency stop)                     | ○<br>(× : Emergency stop)                                       |
|                     | S, T and B codes                            | ×                                             | ○                                             | ○                                                               |
|                     | M code                                      | ×                                             | ×                                             | ×                                                               |
|                     | M, S and T strobe signals                   | ×                                             | ×                                             | ×                                                               |
|                     | Spindle revolution signal (S analog signal) | ×                                             | ○                                             | ○                                                               |
|                     | CNC ready signal MA                         | ON                                            | ○                                             | ○                                                               |
|                     | Servo ready signal SA                       | ON (When other than servo alarm)              | ON (When other than servo alarm)              | ON (When other than servo alarm)                                |
|                     | Cycle start LED (STL)                       | ×                                             | ×                                             | ×                                                               |
| Feed hold LED (SPL) | ×                                           | ×                                             | ×                                             |                                                                 |

**NOTE**

- 1 When heading is performed, the main program number is displayed.
- 2 When a reset is performed during execution of a subprogram, control returns the head of main program.  
Execution cannot be started from the middle of the subprogram.

**F****CHARACTER-TO-CODES CORRESPONDENCE TABLE**

| Char-acter | Code | Comment | Char-acter | Code | Comment              |
|------------|------|---------|------------|------|----------------------|
| A          | 065  |         | 6          | 054  |                      |
| B          | 066  |         | 7          | 055  |                      |
| C          | 067  |         | 8          | 056  |                      |
| D          | 068  |         | 9          | 057  |                      |
| E          | 069  |         |            | 032  | Space                |
| F          | 070  |         | !          | 033  | Exclamation mark     |
| G          | 071  |         | "          | 034  | Quotation mark       |
| H          | 072  |         | #          | 035  | Hash sign            |
| I          | 073  |         | \$         | 036  | Dollar sign          |
| J          | 074  |         | %          | 037  | Percent              |
| K          | 075  |         | &          | 038  | Ampersand            |
| L          | 076  |         | '          | 039  | Apostrophe           |
| M          | 077  |         | (          | 040  | Left parenthesis     |
| N          | 078  |         | )          | 041  | Right parenthesis    |
| O          | 079  |         | *          | 042  | Asterisk             |
| P          | 080  |         | +          | 043  | Plus sign            |
| Q          | 081  |         | ,          | 044  | Comma                |
| R          | 082  |         | -          | 045  | Minus sign           |
| S          | 083  |         | .          | 046  | Period               |
| T          | 084  |         | /          | 047  | Slash                |
| U          | 085  |         | :          | 058  | Colon                |
| V          | 086  |         | ;          | 059  | Semicolon            |
| W          | 087  |         | <          | 060  | Left angle bracket   |
| X          | 088  |         | =          | 061  | Equal sign           |
| Y          | 089  |         | >          | 062  | Right angle bracket  |
| Z          | 090  |         | ?          | 063  | Question mark        |
| 0          | 048  |         | @          | 064  | HAIt mark            |
| 1          | 049  |         | [          | 091  | Left square bracket  |
| 2          | 050  |         | ^          | 092  |                      |
| 3          | 051  |         | ]          | 094  | Right square bracket |
| 4          | 052  |         | _          | 095  | Underscore           |
| 5          | 053  |         |            |      |                      |

# G ALARM LIST

## 1) Program errors (P/S alarm)

| Number | Message                      | Contents                                                                                                                                                                                                                         |
|--------|------------------------------|----------------------------------------------------------------------------------------------------------------------------------------------------------------------------------------------------------------------------------|
| 000    | PLEASE TURN OFF POWER        | A parameter which requires the power off was input, turn off power.                                                                                                                                                              |
| 001    | TH PARITY ALARM              | TH alarm (A character with incorrect parity was input). Correct the tape.                                                                                                                                                        |
| 002    | TV PARITY ALARM              | TV alarm (The number of characters in a block is odd). This alarm will be generated only when the TV check is effective.                                                                                                         |
| 003    | TOO MANY DIGITS              | Data exceeding the maximum allowable number of digits was input. (Refer to the item of max. programmable dimensions.)                                                                                                            |
| 004    | ADDRESS NOT FOUND            | A numeral or the sign “-” was input without an address at the beginning of a block. Modify the program .                                                                                                                         |
| 005    | NO DATA AFTER ADDRESS        | The address was not followed by the appropriate data but was followed by another address or EOB code. Modify the program.                                                                                                        |
| 006    | ILLEGAL USE OF NEGATIVE SIGN | Sign “.” input error (Sign “-” was input after an address with which it cannot be used. Or two or more “-” signs were input.)<br>Modify the program.                                                                             |
| 007    | ILLEGAL USE OF DECIMAL POINT | Decimal point “-” input error (A decimal point was input after an address with which it can not be used. Or two decimal points were input.)<br>Modify the program.                                                               |
| 009    | ILLEGAL ADDRESS INPUT        | Unusable character was input in significant area.<br>Modify the program.                                                                                                                                                         |
| 010    | IMPROPER G-CODE              | An unusable G code or G code corresponding to the function not provided is specified. Modify the program.                                                                                                                        |
| 011    | NO FEEDRATE COMMANDED        | Feedrate was not commanded to a cutting feed or the feedrate was inadequate. Modify the program.                                                                                                                                 |
| 014    | CAN NOT COMMAND G95          | A synchronous feed is specified without the option for threading / synchronous feed.                                                                                                                                             |
| 015    | TOO MANY AXES COMMANDED      | The number of the commanded axes exceeded that of simultaneously controlled axes.                                                                                                                                                |
| 020    | OVER TOLERANCE OF RADIUS     | In circular interpolation (G02 or G03), difference of the distance between the start point and the center of an arc and that between the end point and the center of the arc exceeded the value specified in parameter No. 3410. |
| 021    | ILLEGAL PLANE AXIS COMMANDED | An axis not included in the selected plane (by using G17, G18, G19) was commanded in circular interpolation. Modify the program.                                                                                                 |
| 022    | NO CIRCULAR RADIUS           | When circular interpolation is specified, neither R (specifying an arc radius), nor I, J, and K (specifying the distance from a start point to the center) is specified.                                                         |
| 025    | CANNOT COMMAND F0 IN G02/G03 | F0 (fast feed) was instructed by F1 –digit column feed in circular interpolation. Modify the program.                                                                                                                            |
| 027    | NO AXES COMMANDED IN G43/G44 | No axis is specified in G43 and G44 blocks for the tool length offset type C.<br>Offset is not canceled but another axis is offset for the tool length offset type C. Modify the program.                                        |
| 028    | ILLEGAL PLANE SELECT         | In the plane selection command, two or more axes in the same direction are commanded.<br>Modify the program.                                                                                                                     |

| Number | Message                           | Contents                                                                                                                                                                                                                                                  |
|--------|-----------------------------------|-----------------------------------------------------------------------------------------------------------------------------------------------------------------------------------------------------------------------------------------------------------|
| 029    | ILLEGAL OFFSET VALUE              | The offset values specified by H code is too large. Modify the program.                                                                                                                                                                                   |
| 030    | ILLEGAL OFFSET NUMBER             | The offset number specified by D/H code for tool length offset or cutter compensation is too large. Modify the program.                                                                                                                                   |
| 031    | ILLEGAL P COMMAND IN G10          | In setting an offset amount by G10, the offset number following address P was excessive or it was not specified. Modify the program.                                                                                                                      |
| 032    | ILLEGAL OFFSET VALUE IN G10       | In setting an offset amount by G10 or in writing an offset amount by system variables, the offset amount was excessive.                                                                                                                                   |
| 033    | NO SOLUTION AT CRC                | A point of intersection cannot be determined for cutter compensation C. Modify the program.                                                                                                                                                               |
| 034    | NO CIRC ALLOWED IN ST-UP /EXT BLK | The start up or cancel was going to be performed in the G02 or G03 mode in cutter compensation C. Modify the program.                                                                                                                                     |
| 035    | CAN NOT COMMANDED G39             | G39 is commanded in cutter compensation B cancel mode or on the plane other than offset plane. Modify the program.                                                                                                                                        |
| 036    | CAN NOT COMMANDED G31             | Skip cutting (G31) was specified in cutter compensation mode. Modify the program.                                                                                                                                                                         |
| 037    | CAN NOT CHANGE PLANE IN CRC       | G40 is commanded on the plane other than offset plane in cutter compensation B. The plane selected by using G17, G18 or G19 is changed in cutter compensation C mode. Modify the program.                                                                 |
| 038    | INTERFERENCE IN CIRCULAR BLOCK    | Overcutting will occur in cutter compensation C because the arc start point or end point coincides with the arc center. Modify the program.                                                                                                               |
| 041    | INTERFERENCE IN CRC               | Overcutting will occur in cutter compensation C. Two or more blocks are consecutively specified in which functions such as the auxiliary function and dwell functions are performed without movement in the cutter compensation mode. Modify the program. |
| 042    | G45/G48 NOT ALLOWED IN CRC        | Tool offset (G45 to G48) is commanded in cutter compensation. Modify the program.                                                                                                                                                                         |
| 043    | ILLEGAL T-CODE COMMAND            | In a system using the DRILL-MATE with an ATC, a T code was not specified together with the M06 code in a block. Alternatively, the Tcode was out of range.                                                                                                |
| 044    | G27-G30 NOT ALLOWED IN FIXED CYC  | One of G27 to G30 is commanded in canned cycle mode. Modify the program.                                                                                                                                                                                  |
| 046    | ILLEGAL REFERENCE RETURN COMMAND  | Other than P2, P3 and P4 are commanded for 2nd, 3rd and 4th reference position return command.                                                                                                                                                            |
| 047    | ILLEGAL AXIS SELECT               | For startup of three-dimensional tool compensation or three-dimensional coordinate conversion, two or more axes were specified in the same direction (basic and parallel axes.)                                                                           |
| 048    | BASIC 3 AXIS NOT FOUND            | For startup of three-dimensional tool compensation or three-dimensional coordinate conversion, the three basic axes used when X <sub>p</sub> , Y <sub>p</sub> , and Z <sub>p</sub> are omitted were not specified in parameter No. 1022.                  |
| 050    | CHF/CNR NOT ALLOWED IN THRD BLK   | Chamfering or corner R is commanded in the thread cutting block. Modify the program.                                                                                                                                                                      |
| 051    | MISSING MOVE AFTER CHF/CNR        | Improper movement or the move distance was specified in the block next to the chamfering or corner R block. Modify the program.                                                                                                                           |
| 052    | CODE IS NOT G01 AFTER CHF/ CNR    | The block next to the chamfering or corner R block is not G01, G02, or G03. Modify the program.                                                                                                                                                           |
| 053    | TOO MANY ADDRESS COMMANDS         | For systems without the arbitrary angle chamfering or corner R cutting, a comma was specified. For systems with this feature, a comma was followed by something other than R or C. Correct the program.                                                   |

| Number | Message                              | Contents                                                                                                                                                                                                                                                                                                                                     |
|--------|--------------------------------------|----------------------------------------------------------------------------------------------------------------------------------------------------------------------------------------------------------------------------------------------------------------------------------------------------------------------------------------------|
| 055    | MISSING MOVE VALUE IN CHF/<br>CNR    | In the arbitrary angle chamfering or corner R block, the move distance is less than chamfer or corner R amount.                                                                                                                                                                                                                              |
| 058    | END POINT NOT FOUND                  | In a arbitrary angle chamfering or corner R cutting block, a specified axis is not in the selected plane. Correct the program.                                                                                                                                                                                                               |
| 059    | PROGRAM NUMBER NOT FOUND             | In an external program number search, a specified program number was not found. Otherwise, a program specified for searching is being edited in background processing. Check the program number and external signal. Or discontinue the background editing.                                                                                  |
| 060    | SEQUENCE NUMBER NOT FOUND            | Commanded sequence number was not found in the sequence number search. Check the sequence number.                                                                                                                                                                                                                                            |
| 070    | NO PROGRAM SPACE IN<br>MEMORY        | The memory area is insufficient.<br>Delete any unnecessary programs, then retry.                                                                                                                                                                                                                                                             |
| 071    | DATA NOT FOUND                       | The address to be searched was not found. Or the program with specified program number was not found in program number search.<br>Check the data.                                                                                                                                                                                            |
| 072    | TOO MANY PROGRAMS                    | The number of programs to be stored exceeded 63 (basic), 125 (option), 200 (option), or 400 (option). Delete unnecessary programs and execute program registration again.                                                                                                                                                                    |
| 073    | PROGRAM NUMBER ALREADY IN<br>USE     | The commanded program number has already been used.<br>Change the program number or delete unnecessary programs and execute program registration again.                                                                                                                                                                                      |
| 074    | ILLEGAL PROGRAM NUMBER               | The program number is other than 1 to 9999.<br>Modify the program number.                                                                                                                                                                                                                                                                    |
| 075    | PROTECT                              | An attempt was made to register a program whose number was protected.                                                                                                                                                                                                                                                                        |
| 076    | ADDRESS P NOT DEFINED                | Address P (program number) was not commanded in the block which includes an M98, G65, or G66 command. Modify the program.                                                                                                                                                                                                                    |
| 077    | SUB PROGRAM NESTING ERROR            | The subprogram was called in five folds. Modify the program.                                                                                                                                                                                                                                                                                 |
| 078    | NUMBER NOT FOUND                     | A program number or a sequence number which was specified by address P in the block which includes an M98, M99, M65 or G66 was not found. The sequence number specified by a GOTO statement was not found. Otherwise, a called program is being edited in background processing. Correct the program, or discontinue the background editing. |
| 079    | PROGRAM VERIFY ERROR                 | In memory or program collation, a program in memory does not agree with that read from an external I/O device. Check both the programs in memory and those from the external device.                                                                                                                                                         |
| 080    | G37 ARRIVAL SIGNAL NOT AS-<br>SERTED | In the automatic tool length measurement function (G37), the measurement position reach signal (XAE, YAE, or ZAE) is not turned on within an area specified in parameter 6254 (value $\epsilon$ ).<br>This is due to a setting or operator error.                                                                                            |
| 081    | OFFSET NUMBER NOT FOUND IN<br>G37    | Tool length automatic measurement (G37) was specified without a H code. (Automatic tool length measurement function) Modify the program.                                                                                                                                                                                                     |
| 082    | H-CODE NOT ALLOWED IN G37            | H code and automatic tool compensation (G37) were specified in the same block. (Automatic tool length measurement function) Modify the program.                                                                                                                                                                                              |
| 083    | ILLEGAL AXIS COMMAND IN G37          | In automatic tool length measurement, an invalid axis was specified or the command is incremental. Modify the program.                                                                                                                                                                                                                       |
| 085    | COMMUNICATION ERROR                  | When entering data in the memory by using Reader / Puncher interface, an overrun, parity or framing error was generated. The number of bits of input data or setting of baud rate or specification No. of I/O unit is incorrect.                                                                                                             |

| Number | Message                          | Contents                                                                                                                                                                                                                                                                                                           |
|--------|----------------------------------|--------------------------------------------------------------------------------------------------------------------------------------------------------------------------------------------------------------------------------------------------------------------------------------------------------------------|
| 086    | DR SIGNAL OFF                    | When entering data in the memory by using Reader / Puncher interface, the ready signal (DR) of reader / puncher was off.<br>Power supply of I/O unit is off or cable is not connected or a P.C.B. is defective.                                                                                                    |
| 087    | BUFFER OVERFLOW                  | When entering data in the memory by using Reader / Puncher interface, though the read terminate command is specified, input is not interrupted after 10 characters read. I/O unit or P.C.B. is defective.                                                                                                          |
| 088    | LAN FILE TRANS ERROR (CHANNEL-1) | File data transfer over the OSI-Ethernet was terminated as a result of a transfer error.                                                                                                                                                                                                                           |
| 089    | LAN FILE TRANS ERROR (CHANNEL-2) | File data transfer over the OSI-Ethernet was terminated as a result of a transfer error.                                                                                                                                                                                                                           |
| 090    | REFERENCE RETURN INCOMPLETE      | The reference position return cannot be performed normally because the reference position return start point is too close to the reference position or the speed is too slow. Separate the start point far enough from the reference position, or specify a sufficiently fast speed for reference position return. |
| 091    | REFERENCE RETURN INCOMPLETE      | In the automatic operation halt state, manual reference position return cannot be performed.                                                                                                                                                                                                                       |
| 092    | AXES NOT ON THE REFERENCE POINT  | The commanded axis by G27 (Reference position return check) did not return to the reference position.                                                                                                                                                                                                              |
| 094    | P TYPE NOT ALLOWED (COORD CHG)   | P type cannot be specified when the program is restarted. (After the automatic operation was interrupted, the coordinate system setting operation was performed.) Perform the correct operation according to the operator's manual.                                                                                |
| 095    | P TYPE NOT ALLOWED (EXT OFS CHG) | P type cannot be specified when the program is restarted. (After the automatic operation was interrupted, the external workpiece offset amount changed.)                                                                                                                                                           |
| 096    | P TYPE NOT ALLOWED (WRK OFS CHG) | P type cannot be specified when the program is restarted. (After the automatic operation was interrupted, the workpiece offset amount changed.)                                                                                                                                                                    |
| 097    | P TYPE NOT ALLOWED (AUTO EXEC)   | P type cannot be directed when the program is restarted. (After power ON, after emergency stop or P/S alarm 94 to 97 were reset, no automatic operation is performed.) Perform automatic operation.                                                                                                                |
| 098    | G28 FOUND IN SEQUENCE RETURN     | A command of the program restart was specified without the reference position return operation after power ON or emergency stop, and G28 was found during search. Perform the reference position return.                                                                                                           |
| 099    | MDI EXEC NOT ALLOWED AFT. SEARCH | After completion of search in program restart, a move command is given with MDI.                                                                                                                                                                                                                                   |
| 100    | PARAMETER WRITE ENABLE           | On the PARAMETER (SETTING) screen, PWE (parameter writing enabled) is set to 1. Set it to 0, then reset the system.                                                                                                                                                                                                |
| 101    | PLEASE CLEAR MEMORY              | The power turned off while rewriting the memory by program edit operation. If this alarm has occurred, press <RESET> while pressing <PROG>, and only the program being edited will be deleted. Register the deleted program.                                                                                       |
| 109    | FORMAT ERROR IN G08              | A value other than 0 or 1 was specified after P in the G08 code, or no value was specified.                                                                                                                                                                                                                        |
| 110    | DATA OVERFLOW                    | The absolute value of fixed decimal point display data exceeds the allowable range. Modify the program.                                                                                                                                                                                                            |
| 111    | CALCULATED DATA OVERFLOW         | The result of calculation is out of the allowable range ( $-10^{47}$ to $-10^{-29}$ , 0, and $10^{-29}$ to $10^{47}$ ).                                                                                                                                                                                            |
| 112    | DIVIDED BY ZERO                  | Division by zero was specified. (including $\tan 90^\circ$ )                                                                                                                                                                                                                                                       |
| 113    | IMPROPER COMMAND                 | A function which cannot be used in custom macro is commanded. Modify the program.                                                                                                                                                                                                                                  |



| Number | Message                           | Contents                                                                                                                                                                                                                                                                                                                                                                                                                                                                                                                                                                                                                                                                                                                                                                                                                                                                                                                                              |
|--------|-----------------------------------|-------------------------------------------------------------------------------------------------------------------------------------------------------------------------------------------------------------------------------------------------------------------------------------------------------------------------------------------------------------------------------------------------------------------------------------------------------------------------------------------------------------------------------------------------------------------------------------------------------------------------------------------------------------------------------------------------------------------------------------------------------------------------------------------------------------------------------------------------------------------------------------------------------------------------------------------------------|
| 114    | FORMAT ERROR IN MACRO             | There is an error in other formats than <Formula>.<br>Modify the program.                                                                                                                                                                                                                                                                                                                                                                                                                                                                                                                                                                                                                                                                                                                                                                                                                                                                             |
| 115    | ILLEGAL VARIABLE NUMBER           | A value not defined as a variable number is designated in the custom macro or in high-speed cycle cutting.<br>The header contents are improper in a high-speed cycle cutting. This alarm is given in the following cases:<br><ol style="list-style-type: none"> <li>1. The header corresponding to the specified machining cycle number called is not found.</li> <li>2. The cycle connection data value is out of the allowable range (0 – 999).</li> <li>3. The number of data in the header is out of the allowable range (0 – 32767).</li> <li>4. The start data variable number of executable format data is out of the allowable range (#20000 – #85535).</li> <li>5. The storing data variable number of executable format data is out of the allowable range (#85535).</li> <li>6. The storing start data variable number of executable format data is overlapped with the variable number used in the header.</li> </ol> Modify the program. |
| 116    | WRITE PROTECTED VARIABLE          | The left side of substitution statement is a variable whose substitution is inhibited. Modify the program.                                                                                                                                                                                                                                                                                                                                                                                                                                                                                                                                                                                                                                                                                                                                                                                                                                            |
| 118    | PARENTHESIS NESTING ERROR         | The nesting of bracket exceeds the upper limit (quintuple).<br>Modify the program.                                                                                                                                                                                                                                                                                                                                                                                                                                                                                                                                                                                                                                                                                                                                                                                                                                                                    |
| 119    | ILLEGAL ARGUMENT                  | The SQRT argument is negative, BCD argument is negative, or other values than 0 to 9 are present on each line of BIN argument.<br>Modify the program.                                                                                                                                                                                                                                                                                                                                                                                                                                                                                                                                                                                                                                                                                                                                                                                                 |
| 122    | QUADRUPLICATE MACRO MODAL-CALL    | A total of four macro calls and macro modal calls are nested. Correct the program.                                                                                                                                                                                                                                                                                                                                                                                                                                                                                                                                                                                                                                                                                                                                                                                                                                                                    |
| 123    | CAN NOT USE MACRO COMMAND IN DNC  | Macro control command is used during DNC operation.<br>Modify the program.                                                                                                                                                                                                                                                                                                                                                                                                                                                                                                                                                                                                                                                                                                                                                                                                                                                                            |
| 124    | MISSING END STATEMENT             | DO – END does not correspond to 1 : 1. Modify the program.                                                                                                                                                                                                                                                                                                                                                                                                                                                                                                                                                                                                                                                                                                                                                                                                                                                                                            |
| 125    | FORMAT ERROR IN MACRO             | <Formula> format is erroneous. Modify the program.                                                                                                                                                                                                                                                                                                                                                                                                                                                                                                                                                                                                                                                                                                                                                                                                                                                                                                    |
| 126    | ILLEGAL LOOP NUMBER               | In DO n, $1 \leq n \leq 3$ is not established. Modify the program.                                                                                                                                                                                                                                                                                                                                                                                                                                                                                                                                                                                                                                                                                                                                                                                                                                                                                    |
| 127    | NC, MACRO STATEMENT IN SAME BLOCK | NC and custom macro commands coexist.<br>Modify the program.                                                                                                                                                                                                                                                                                                                                                                                                                                                                                                                                                                                                                                                                                                                                                                                                                                                                                          |
| 128    | ILLEGAL MACRO SEQUENCE NUMBER     | The sequence number specified in the branch command was not 0 to 9999. Or, it cannot be searched. Modify the program.                                                                                                                                                                                                                                                                                                                                                                                                                                                                                                                                                                                                                                                                                                                                                                                                                                 |
| 129    | ILLEGAL ARGUMENT ADDRESS          | An address which is not allowed in <Argument Designation > is used.<br>Modify the program.                                                                                                                                                                                                                                                                                                                                                                                                                                                                                                                                                                                                                                                                                                                                                                                                                                                            |
| 130    | ILLEGAL AXIS OPERATION            | An axis control command was given by PMC to an axis controlled by CNC. Or an axis control command was given by CNC to an axis controlled by PMC. Modify the program.                                                                                                                                                                                                                                                                                                                                                                                                                                                                                                                                                                                                                                                                                                                                                                                  |
| 131    | TOO MANY EXTERNAL ALARM MESSAGES  | Five or more alarms have generated in external alarm message. Consult the PMC ladder diagram to find the cause.                                                                                                                                                                                                                                                                                                                                                                                                                                                                                                                                                                                                                                                                                                                                                                                                                                       |
| 132    | ALARM NUMBER NOT FOUND            | No alarm No. concerned exists in external alarm message clear. Check the PMC ladder diagram.                                                                                                                                                                                                                                                                                                                                                                                                                                                                                                                                                                                                                                                                                                                                                                                                                                                          |
| 133    | ILLEGAL DATA IN EXT. ALARM MSG    | Small section data is erroneous in external alarm message or external operator message. Check the PMC ladder diagram.                                                                                                                                                                                                                                                                                                                                                                                                                                                                                                                                                                                                                                                                                                                                                                                                                                 |
| 135    | ILLEGAL ANGLE COMMAND             | The index table indexing positioning angle was instructed in other than an integral multiple of the value of the minimum angle.<br>Modify the program.                                                                                                                                                                                                                                                                                                                                                                                                                                                                                                                                                                                                                                                                                                                                                                                                |

| Number | Message                                              | Contents                                                                                                                                                                                                                                                                                                          |
|--------|------------------------------------------------------|-------------------------------------------------------------------------------------------------------------------------------------------------------------------------------------------------------------------------------------------------------------------------------------------------------------------|
| 136    | ILLEGAL AXIS COMMAND                                 | In index table indexing, another control axis was instructed together with the B axis.<br>Modify the program.                                                                                                                                                                                                     |
| 138    | SUPERIMPOSED DATA OVERFLOW                           | In PMC-based axis control, the increment for pulse distribution on the CNC and PMC side are too large when the superimposed control extended function is used.                                                                                                                                                    |
| 139    | CAN NOT CHANGE PMC CONTROL AXIS                      | An axis is selected in commanding by PMC axis control.<br>Modify the program.                                                                                                                                                                                                                                     |
| 141    | CAN NOT COMMAND G51 IN CRC                           | G51 (Scaling ON) is commanded in the tool offset mode.<br>Modify the program.                                                                                                                                                                                                                                     |
| 142    | ILLEGAL SCALE RATE                                   | Scaling magnification is commanded in other than 1 – 999999.<br>Correct the scaling magnification setting (G51 Pp .. or parameter 5411 or 5421).                                                                                                                                                                  |
| 143    | SCALED MOTION DATA OVERFLOW                          | The scaling results, move distance, coordinate value and circular radius exceed the maximum command value. Correct the program or scaling magnification.                                                                                                                                                          |
| 144    | ILLEGAL PLANE SELECTED                               | The coordinate rotation plane and arc or cutter compensation C plane must be the same. Modify the program.                                                                                                                                                                                                        |
| 145    | ILLEGAL CONDITIONS IN POLAR COORDINATE INTERPOLATION | The conditions are incorrect when the polar coordinate interpolation starts or it is canceled.<br>1) In modes other than G40, G12.1/G13.1 was specified.<br>2) An error is found in the plane selection. Parameters No. 5460 and No. 5461 are incorrectly specified.<br>Modify the value of program or parameter. |
| 146    | IMPROPER G CODE                                      | G codes which cannot be specified in the polar coordinate interpolation mode was specified. See section polar coordinate interpolation and modify the program.                                                                                                                                                    |
| 148    | ILLEGAL SETTING DATA                                 | Automatic corner override deceleration rate is out of the settable range of judgement angle. Modify the parameters (No.1710 to No.1714)                                                                                                                                                                           |
| 149    | FORMAT ERROR IN G10L3                                | A code other than Q1,Q2,P1 or P2 was specified as the life count type in the extended tool life management.                                                                                                                                                                                                       |
| 150    | ILLEGAL TOOL GROUP NUMBER                            | Tool Group No. exceeds the maximum allowable value.<br>Modify the program.                                                                                                                                                                                                                                        |
| 151    | TOOL GROUP NUMBER NOT FOUND                          | The tool group commanded in the machining program is not set.<br>Modify the value of program or parameter.                                                                                                                                                                                                        |
| 152    | NO SPACE FOR TOOL ENTRY                              | The number of tools within one group exceeds the maximum value registerable. Modify the number of tools.                                                                                                                                                                                                          |
| 153    | T-CODE NOT FOUND                                     | In the registration of tool life data, a T code was not specified in a block where it is required. Alternatively, only M06 was specified in a block for tool change type D. Correct the program.                                                                                                                  |
| 154    | NOT USING TOOL IN LIFE GROUP                         | When the group is not commanded, H99 or D99 was commanded.<br>Correct the program.                                                                                                                                                                                                                                |
| 155    | ILLEGAL T-CODE IN M06                                | In the machining program, M06 and T code in the same block do not correspond to the group in use. Correct the program.                                                                                                                                                                                            |
| 156    | P/L COMMAND NOT FOUND                                | P and L commands are missing at the head of program in which the tool group is set. Correct the program.                                                                                                                                                                                                          |
| 157    | TOO MANY TOOL GROUPS                                 | The number of tool groups to be set exceeds the maximum allowable value. See parameter GS1, GS2 (No. 6800 bit 0 and 1). Modify the program.                                                                                                                                                                       |
| 158    | ILLEGAL TOOL LIFE DATA                               | The tool life to be set is too excessive. Modify the setting value.                                                                                                                                                                                                                                               |
| 159    | TOOL DATA SETTING INCOMPLETE                         | During executing a life data setting program, power was turned off.<br>Set again.                                                                                                                                                                                                                                 |

| Number | Message                                                      | Contents                                                                                                                                                                                                                                                                                                                                                                            |
|--------|--------------------------------------------------------------|-------------------------------------------------------------------------------------------------------------------------------------------------------------------------------------------------------------------------------------------------------------------------------------------------------------------------------------------------------------------------------------|
| 160    | G72.1 NESTING ERROR                                          | Code G72.1 was specified in a sub-program after the same code had already been specified for copying with rotation.                                                                                                                                                                                                                                                                 |
| 161    | G72.2 NESTING ERROR                                          | Code G72.2 was specified in a sub-program after the same code had already been specified for parallel copying.                                                                                                                                                                                                                                                                      |
| 175    | ILLEGAL G107 COMMAND                                         | Conditions when performing cylindrical interpolation start or cancel not correct. To change the mode to the cylindrical interpolation mode, specify the command in a format of "G07.1 rotation-axis name radius of cylinder."                                                                                                                                                       |
| 176    | IMPROPER G-CODE IN G107                                      | Any of the following G codes which cannot be specified in the cylindrical interpolation mode was specified.<br>1) G codes for positioning, such as G28,, G73, G74, G76, G81 – G89, including the codes specifying the rapid traverse cycle<br>2) G codes for setting a coordinate system: G52,G92,<br>3) G code for selecting coordinate system: G53 G54–G59<br>Modify the program. |
| 177    | CHECK SUM ERROR<br>(G05 MODE)                                | Check sum error<br>Modify the program.                                                                                                                                                                                                                                                                                                                                              |
| 178    | G05 COMMANDED IN G41/G42<br>MODE                             | G05 was commanded in the G41/G42 mode.<br>Correct the program.                                                                                                                                                                                                                                                                                                                      |
| 179    | PARAM. (PRM NO. 7510) SETTING<br>ERROR                       | The number of controlled axes set by the parameter 7510 exceeds the maximum number. Modify the parameter setting value.                                                                                                                                                                                                                                                             |
| 180    | COMMUNICATION ERROR<br>(REMOTE BUF)                          | Remote buffer connection alarm has generated. Confirm the number of cables, parameters and I/O device.                                                                                                                                                                                                                                                                              |
| 181    | FORMAT ERROR IN G81 BLOCK<br><br>(gear hobbing machine, EGB) | G81 block format error (hobbing machine)<br>1) T (number of teeth) has not been instructed.<br>2) Data outside the command range was instructed by either T, L, Q or P.<br>3) Calculation of the synchronization coefficient has overflowed.<br>Modify the program.                                                                                                                 |
| 182    | G81 NOT COMMANDED<br><br>(gear hobbing machine)              | G83 (C axis servo lag quantity offset) was instructed though synchronization by G81 has not been instructed. Correct the program. (hobbing machine)                                                                                                                                                                                                                                 |
| 183    | DUPLICATE G83 (COMMANDS)<br>(gear hobbing machine)           | G83 was instructed before canceled by G82 after compensating for the C axis servo lag quantity by G83. (hobbing machine)                                                                                                                                                                                                                                                            |
| 184    | ILLEGAL COMMAND IN G81<br><br>(gear hobbing machine, EGB)    | A command not to be instructed during synchronization by G81 was instructed. (hobbing machine)<br>1) A C axis command by G00, G27, G28, G29, G30, etc. was instructed.<br>2) Inch/Metric switching by G20, G21 was instructed.                                                                                                                                                      |
| 185    | RETURN TO REFERENCE POINT<br><br>(gear hobbing machine)      | G81 was instructed without performing reference position return after power on or emergency stop. (hobbing machine) Perform reference position return.                                                                                                                                                                                                                              |
| 186    | PARAMETER SETTING ERROR<br><br>(gear hobbing machine, EGB)   | Parameter error regarding G81 (hobbing machine)<br>1) The C axis has not been set to be a rotary axis.<br>2) A hob axis and position coder gear ratio setting error                                                                                                                                                                                                                 |
| 190    | ILLEGAL AXIS SELECT                                          | In the constant surface speed control, the axis specification is wrong. (See parameter No. 3770.) The specified axis command (P) contains an illegal value.<br>Correct the program.                                                                                                                                                                                                 |

| Number | Message                                    | Contents                                                                                                                                                                                                                                                                                                                                                                                                                                                                                                                                                                              |
|--------|--------------------------------------------|---------------------------------------------------------------------------------------------------------------------------------------------------------------------------------------------------------------------------------------------------------------------------------------------------------------------------------------------------------------------------------------------------------------------------------------------------------------------------------------------------------------------------------------------------------------------------------------|
| 194    | SPINDLE COMMAND IN SYN-CHRO-MODE           | A contour control mode, spindle positioning (Cs-axis control) mode, or rigid tapping mode was specified during the serial spindle synchronous control mode. Correct the program so that the serial spindle synchronous control mode is released in advance.                                                                                                                                                                                                                                                                                                                           |
| 197    | C-AXIS COMMANDED IN SPINDLE MODE           | The program specified a movement along the Cs-axis when the signal CON(DGN=G027#7) was off. Correct the program, or consult the PMC ladder diagram to find the reason the signal is not turned on.                                                                                                                                                                                                                                                                                                                                                                                    |
| 199    | MACRO WORD UNDEFINED                       | Undefined macro word was used. Modify the custom macro.                                                                                                                                                                                                                                                                                                                                                                                                                                                                                                                               |
| 200    | ILLEGAL S CODE COMMAND                     | In the rigid tap, an S value is out of the range or is not specified. The maximum value for S which can be specified in rigid tapping is set in parameter (No.5241 to 5243). Change the setting in the parameter or modify the program.                                                                                                                                                                                                                                                                                                                                               |
| 201    | FEEDRATE NOT FOUND IN RIGID TAP            | In the rigid tapping, no F value is specified. Correct the program.                                                                                                                                                                                                                                                                                                                                                                                                                                                                                                                   |
| 202    | POSITION LSI OVERFLOW                      | In the rigid tapping, spindle distribution value is too large.                                                                                                                                                                                                                                                                                                                                                                                                                                                                                                                        |
| 203    | PROGRAM MISS AT RIGID TAPPING              | In the rigid tapping, position for a rigid M code (M29) or an S command is incorrect. Modify the program.                                                                                                                                                                                                                                                                                                                                                                                                                                                                             |
| 204    | ILLEGAL AXIS OPERATION                     | In the rigid tapping, an axis movement is specified between the rigid M code (M29) block and G84 (G74) block. Modify the program.                                                                                                                                                                                                                                                                                                                                                                                                                                                     |
| 205    | RIGID MODE DI SIGNAL OFF                   | Rigid tapping signal (DGNG 061#1) is not 1 when G84 (G74) is executed though the rigid M code (M29) is specified. Consult the PMC ladder diagram to find the reason the DI signal is not turned on. Modify the program.                                                                                                                                                                                                                                                                                                                                                               |
| 206    | CAN NOT CHANGE PLANE (RIGID TAP)           | Plane changeover was instructed in the rigid mode. Correct the program.                                                                                                                                                                                                                                                                                                                                                                                                                                                                                                               |
| 207    | RIGID DATA MISMATCH                        | The specified distance was too short or too long in rigid tapping.                                                                                                                                                                                                                                                                                                                                                                                                                                                                                                                    |
| 210    | CAN NOT COMAND M198/M99                    | 1) M198 and M99 are executed in the schedule operation. Or M198 is executed in the DNC operation.<br>2) In a multiple repetitive pocketing canned cycle, an interrupt macro was specified, and M99 was executed.                                                                                                                                                                                                                                                                                                                                                                      |
| 212    | ILLEGAL PLANE SELECT                       | The arbitrary angle chamfering or a corner R is commanded or the plane including an additional axis. Correct the program.                                                                                                                                                                                                                                                                                                                                                                                                                                                             |
| 213    | ILLEGAL COMMAND IN SYN-CHRO-MODE           | Any of the following alarms occurred in the operation with the simple synchronization control.<br>1) The program issued the move command to the slave axis.<br>2) The program issued the manual continuous feed/manual handle feed/incremental feed command to the slave axis.<br>3) The program issued the automatic reference position return command without executing the manual reference position return after the power was turned on.<br>4) The difference between the position error amount of the master and slave axes exceeded the value specified in parameter No. 8313. |
| 214    | ILLEGAL COMMAND IN SYN-CHRO-MODE           | Coordinate system is set or tool compensation of the shift type is executed in the synchronous control. Correct the program.                                                                                                                                                                                                                                                                                                                                                                                                                                                          |
| 222    | DNC OP. NOT ALLOWED IN BG.-EDIT            | Input and output are executed at a time in the background edition. Execute a correct operation.                                                                                                                                                                                                                                                                                                                                                                                                                                                                                       |
| 224    | RETURN TO REFERENCE POINT                  | Reference position return has not been performed before the automatic operation starts. Perform reference position return only when parameter ZRN <sub>x</sub> (No.1005#0) is 0.                                                                                                                                                                                                                                                                                                                                                                                                      |
| 230    | R CODE NOT FOUND<br>(for grinding machine) | The infeed quantity R has not been instructed for the G161 block. Or the R command value is negative. Correct the program.                                                                                                                                                                                                                                                                                                                                                                                                                                                            |

| Number | Message                        | Contents                                                                                                                                                                                                                                                                                                                                                                                                                                                                                                                                                                                                                                                                                                                                                                                                                                                                                                                                                                                                                                                                                                        |
|--------|--------------------------------|-----------------------------------------------------------------------------------------------------------------------------------------------------------------------------------------------------------------------------------------------------------------------------------------------------------------------------------------------------------------------------------------------------------------------------------------------------------------------------------------------------------------------------------------------------------------------------------------------------------------------------------------------------------------------------------------------------------------------------------------------------------------------------------------------------------------------------------------------------------------------------------------------------------------------------------------------------------------------------------------------------------------------------------------------------------------------------------------------------------------|
| 231    | ILLEGAL FORMAT IN G10 OR L50   | Any of the following errors occurred in the specified format at the programmable-parameter input.<br>1) Address N or R was not entered.<br>2) A number not specified for a parameter was entered.<br>3) The axis number was too large.<br>4) An axis number was not specified in the axis-type parameter.<br>5) An axis number was specified in the parameter which is not an axis type.<br>6) An attempt was made to reset bit 4 of parameter 3202 (NE9) or change parameter 3210 (PSSWD) when they are protected by a password. Correct the program.                                                                                                                                                                                                                                                                                                                                                                                                                                                                                                                                                          |
| 232    | TOO MANY HELICAL AXIS COMMANDS | Three or more axes (in the normal direction control mode two or more axes) were specified as helical axes in the helical interpolation mode.                                                                                                                                                                                                                                                                                                                                                                                                                                                                                                                                                                                                                                                                                                                                                                                                                                                                                                                                                                    |
| 233    | DEVICE BUSY                    | When an attempt was made to use a unit such as that connected via the RS-232-C interface, other users were using it.                                                                                                                                                                                                                                                                                                                                                                                                                                                                                                                                                                                                                                                                                                                                                                                                                                                                                                                                                                                            |
| 239    | BP/S ALARM                     | While punching was being performed with the function for controlling external I/O units ,background editing was performed.                                                                                                                                                                                                                                                                                                                                                                                                                                                                                                                                                                                                                                                                                                                                                                                                                                                                                                                                                                                      |
| 240    | BP/S ALARM                     | Background editing was performed during MDI operation.                                                                                                                                                                                                                                                                                                                                                                                                                                                                                                                                                                                                                                                                                                                                                                                                                                                                                                                                                                                                                                                          |
| 241    | ILLEGAL FORMAT IN G02.2/G03.2  | The end point, I , J , K , or R was not specified for involute interpolation.                                                                                                                                                                                                                                                                                                                                                                                                                                                                                                                                                                                                                                                                                                                                                                                                                                                                                                                                                                                                                                   |
| 242    | ILLEGAL COMMAND IN G02.2/G03.2 | An erroneous value was specified for involute interpolation.<br>The start or end point was specified within the base circle.<br>The value 0 was specified for I , J , K , or R,.<br>The start or end point exceeds 100 revolutions from the involute curve start point.                                                                                                                                                                                                                                                                                                                                                                                                                                                                                                                                                                                                                                                                                                                                                                                                                                         |
| 243    | OVER TOLERANCE OF END POINT    | The end point was not positioned on the involute curve which started at the start point, and the end point was out of the range specified by parameter No.5610.                                                                                                                                                                                                                                                                                                                                                                                                                                                                                                                                                                                                                                                                                                                                                                                                                                                                                                                                                 |
| 250    | Z AXIS WRONG COMMAND (ATC)     | In a system using the DRILL-MATE with an ATC, movement along the Z-axis was specified in a block in which a command for changing tools (M06 T_)was specified.                                                                                                                                                                                                                                                                                                                                                                                                                                                                                                                                                                                                                                                                                                                                                                                                                                                                                                                                                   |
| 251    | ATC ERROR                      | An error occurs in the DRILL-MATE in the following cases :<br><ul style="list-style-type: none"> <li>• When unusable T code is specified in M06 T_</li> <li>• When the M06 code is specified when the Z coordinate is positive in the machine coordinate system.</li> <li>• When parameter No. 7810, which specifies the current tool number, is 0.</li> <li>• When the M06 code is specified in the canned-cycle mode.</li> <li>• When the M06 code is specified in a block in which a reference position return code, G27,G28, G29, or G30 is specified.</li> <li>• When the M06 code is specified in the tool compensation mode (G41 to G44).</li> <li>• When the M06 code is specified without any reference position return after the power is turned on or after the emergency stop is released.</li> <li>• When the machine lock signal or the signal for ignoring the Z-axis is turned on while the tool is being changed.</li> <li>• When a "prying" condition is detected while the tool is changed.</li> <li>• Refer to diagnosis parameter No. 530 for identifying the situations above.</li> </ul> |
| 252    | ATC SPINDLE ALARM              | An error due to excessive deviation occurs in spindle positioning during ATC operation. For details, see diagnosis parameter No.531. (Only for the DRILL-MATE)                                                                                                                                                                                                                                                                                                                                                                                                                                                                                                                                                                                                                                                                                                                                                                                                                                                                                                                                                  |
| 253    | G05 IS NOT AVAILABLE           | Binary-input operation with a high-speed remote buffer (G05) or high-speed cycle machining (G05) has been specified in look-ahead control mode (G08P1). Before attempting to specify these commands, first specify G08P0; to cancel look-ahead control mode.                                                                                                                                                                                                                                                                                                                                                                                                                                                                                                                                                                                                                                                                                                                                                                                                                                                    |

| Number | Message                            | Contents                                                                                                                                                                                                                                                                                                                                                                                                                                                                                                                                                                                                                                                                                                                               |
|--------|------------------------------------|----------------------------------------------------------------------------------------------------------------------------------------------------------------------------------------------------------------------------------------------------------------------------------------------------------------------------------------------------------------------------------------------------------------------------------------------------------------------------------------------------------------------------------------------------------------------------------------------------------------------------------------------------------------------------------------------------------------------------------------|
| 5000   | ILLEGAL COMMAND CODE               | The specified code was incorrect in the high-precision contour control (HPCC) mode.                                                                                                                                                                                                                                                                                                                                                                                                                                                                                                                                                                                                                                                    |
| 5003   | ILLEGAL PARAMETER (HPCC)           | The parameter setting is incorrect.                                                                                                                                                                                                                                                                                                                                                                                                                                                                                                                                                                                                                                                                                                    |
| 5004   | HPCC NOT READY                     | High-precision contour control is not ready.                                                                                                                                                                                                                                                                                                                                                                                                                                                                                                                                                                                                                                                                                           |
| 5006   | TOO MANY WORD IN ONE BLOCK         | The number of words specified in a block exceeded 26 in the HPCC mode.                                                                                                                                                                                                                                                                                                                                                                                                                                                                                                                                                                                                                                                                 |
| 5007   | TOO LARGE DISTANCE                 | In the HPCC mode, the machine moved beyond the limit.                                                                                                                                                                                                                                                                                                                                                                                                                                                                                                                                                                                                                                                                                  |
| 5009   | PARAMETER ZERO (DRY RUN)           | The maximum feedrate (parameter No. 1422) or the feedrate in dry run (parameter No. 1410) is 0 in the HPCC model.                                                                                                                                                                                                                                                                                                                                                                                                                                                                                                                                                                                                                      |
| 5010   | END OF RECORD                      | The end of record (%) was specified.                                                                                                                                                                                                                                                                                                                                                                                                                                                                                                                                                                                                                                                                                                   |
| 5011   | PARAMETER ZERO(CUT MAX)            | The maximum cutting feedrate (parameter No. 1422) is 0 in the HPCC mode.                                                                                                                                                                                                                                                                                                                                                                                                                                                                                                                                                                                                                                                               |
| 5012   | G05 P10000 ILLEGAL START UP (HPCC) | G05 P10000 has been specified in a mode from which HPCC mode cannot be entered.                                                                                                                                                                                                                                                                                                                                                                                                                                                                                                                                                                                                                                                        |
| 5013   | HPCC:CRC OFS REMAIN AT CANCEL      | G05P0 has been specified in G41/G42 mode or before cancellation axis is not found.                                                                                                                                                                                                                                                                                                                                                                                                                                                                                                                                                                                                                                                     |
| 5014   | TRACE DATA NOT FOUND               | Trace data is not available, preventing transfer from being performed.                                                                                                                                                                                                                                                                                                                                                                                                                                                                                                                                                                                                                                                                 |
| 5015   | NO ROTATION AXIS                   | During tool axis direction handle feed or tool axis normal direction handle feed, the specified rotation axis cannot be found.                                                                                                                                                                                                                                                                                                                                                                                                                                                                                                                                                                                                         |
| 5016   | ILLEGAL COMBINATION OF M CODE      | M codes which belonged to the same group were specified in a block. Alternatively, an M code which must be specified without other M codes in the block was specified in a block with other M codes.                                                                                                                                                                                                                                                                                                                                                                                                                                                                                                                                   |
| 5020   | PARAMETER OF RESTART ERROR         | The parameter for specifying program restart is not set correctly.                                                                                                                                                                                                                                                                                                                                                                                                                                                                                                                                                                                                                                                                     |
| 5043   | TOO MANY G68 NESTING               | The G68 command for three-dimensional coordinate conversion has been specified three or more times.                                                                                                                                                                                                                                                                                                                                                                                                                                                                                                                                                                                                                                    |
| 5044   | G68 FORMAT ERROR                   | The G68 block contains a format error. This alarm occurs in the following cases:<br><ol style="list-style-type: none"> <li>1 One of I, J, and K is not specified in the G68 block (missing option for coordinate conversion).</li> <li>2 I, J, and K are 0 in the G68 block.</li> <li>3 R is not specified in the G68 block.</li> </ol>                                                                                                                                                                                                                                                                                                                                                                                                |
| 5046   | ILLEGAL PARAMETER (ST.COMP)        | An illegal parameter has been specified for straightness compensation.<br>Possible reasons are as follows:<br><ol style="list-style-type: none"> <li>1 There is no axis corresponding to the axis number specified in the move axis or compensation axis parameter.</li> <li>2 More than 128 pitch error compensation points are not sequentially numbered.</li> <li>3 The straightness compensation points are not sequentially numbered.</li> <li>4 A specified straightness compensation point is outside the range between the pitch error compensation points having the maximum positive and negative coordinates.</li> <li>5 The compensation value specified for each compensation point is too large or too small.</li> </ol> |
| 5050   | ILL-COMMAND IN CHOPPING MODE       | When the chopping function is used, a move command was specified for a chopping axis in chopping mode (during reciprocation between a top dead point and bottom dead point).                                                                                                                                                                                                                                                                                                                                                                                                                                                                                                                                                           |

| Number | Message                          | Contents                                                                                                                                                                                                                                                                                                                                                                                                                       |
|--------|----------------------------------|--------------------------------------------------------------------------------------------------------------------------------------------------------------------------------------------------------------------------------------------------------------------------------------------------------------------------------------------------------------------------------------------------------------------------------|
| 5051   | M-NET CODE ERROR                 | When the chopping function is used, a move command was specified for a chopping axis in chopping mode (during reciprocation between a top dead point and bottom dead point).                                                                                                                                                                                                                                                   |
| 5052   | M-NET ETX ERROR                  | "ETX" code is abnormal.                                                                                                                                                                                                                                                                                                                                                                                                        |
| 5053   | M-NET CONNECT ERROR              | Connection time supervision error (parameter No.175)                                                                                                                                                                                                                                                                                                                                                                           |
| 5054   | M-NET RECEIVE ERROR              | Boring time supervision error (parameter No.176)                                                                                                                                                                                                                                                                                                                                                                               |
| 5055   | M-NET PRT/FRM ERROR              | Vertical parity or framing error detection                                                                                                                                                                                                                                                                                                                                                                                     |
| 5057   | M-NET BOARD SYSTEM DOWN          | Transmit time-out error (parameter No. 177)<br>ROM parity error<br>CPU interruption detection of not listed above                                                                                                                                                                                                                                                                                                              |
| 5060   | ILLEGAL PARAMETER IN G02.3/G03.3 | Parameter setting is illegal.<br>No. 5641 (setting of the linear axis) is not specified.<br>No. 5641 specifies an axis other than a linear axis.<br>No. 5642 (setting of the rotation axis) is not specified.<br>No. 5642 specifies an axis other than a rotation axis.<br>The CNC cannot control the linear or rotation axis (the value of No. 1010 is exceeded).                                                             |
| 5061   | ILLEGAL FORMAT IN G02.3/G03.3    | The command for exponential interpolation (G02.3/G03.3) contains a format error.<br>Address I, J, or K is not specified.<br>Addresses I, J, and K are 0.                                                                                                                                                                                                                                                                       |
| 5062   | ILLEGAL COMMAND IN G02.3/G03.3   | The command for exponential interpolation (G02.3/G03.3) contains an illegal value.<br>The specified value is not suitable for exponential interpolation (for example, a negative value is subject to ln).                                                                                                                                                                                                                      |
| 5063   | IS NOT PRESET AFTER REF.         | This message is output when the position counter has not been preset before the start of plate thickness measurement. This alarm is issued in one of the cases below.<br><br>1) When an attempt was made to perform measurement before a reference position had been established.<br><br>2) When, after manual reference position return, an attempt was made to start measurement without first setting the position counter. |
| 5064   | DIFFERENT AXIS UNIT (IS-B, IS-C) | Circular interpolation was specified for a plane formed by axes using different increment systems.                                                                                                                                                                                                                                                                                                                             |
| 5065   | DIFFERENT AXIS UNIT (PMC AXIS)   | In PMC-based axis control, axes using different increment systems are specified for the same DI/DO group. Modify parameter No. 8010.                                                                                                                                                                                                                                                                                           |
| 5066   | RESTART ILLEGAL SEQUENCE NUMBER  | During program restart using the return/restart function, a sequence number between 7000 and 7999 was read while performing search for the next sequence number.                                                                                                                                                                                                                                                               |
| 5068   | G31 P90 FORMAT ERROR             | No axis is specified for movement.<br>Two or more axes were specified for movement.                                                                                                                                                                                                                                                                                                                                            |
| 5069   | WHL-C; ILLEGAL P-DATA            | The P data, specified for selecting the compensation center for grinding wheel wear compensation, is invalid.                                                                                                                                                                                                                                                                                                                  |
| 5073   | NO DECIMAL POINT                 | A decimal point is not specified for a command for which a decimal point must be specified.                                                                                                                                                                                                                                                                                                                                    |
| 5074   | ADDRESS DUPLICATION ERROR        | The same address appears more than once in a block. Alternatively, a block contains two or more G codes belonging to the same group.                                                                                                                                                                                                                                                                                           |
| 5082   | DATA SERVER ERROR                | Details are displayed on the data server message screen.                                                                                                                                                                                                                                                                                                                                                                       |
| 5085   | SMOOTH IPL ERROR 1               | A block for specifying smooth interpolation contains a syntax error.                                                                                                                                                                                                                                                                                                                                                           |

## 2) Background edit alarm

| Number | Message    | Contents                                                                                                                                                                  |
|--------|------------|---------------------------------------------------------------------------------------------------------------------------------------------------------------------------|
| ???    | BP/S alarm | BP/S alarm occurs in the same number as the P/S alarm that occurs in ordinary program edit.<br>(P/S alarm No. 070, 071, 072, 073, 074, 085 to 087)<br>Modify the program. |
| 140    | BP/S alarm | It was attempted to select or delete in the background a program being selected in the foreground. <b>(Note)</b><br>Use background editing correctly.                     |

### NOTE

Alarm in background edit is displayed in the key input line of the background edit screen instead of the ordinary alarm screen and is resettable by any of the MDI key operation.

## 3) Absolute pulse coder (APC) alarm

| Number | Message                               | Contents                                                                                                                                                                                                                             |
|--------|---------------------------------------|--------------------------------------------------------------------------------------------------------------------------------------------------------------------------------------------------------------------------------------|
| 300    | nth-axis origin return                | Manual reference position return is required for the nth-axis (n=1 – 8).                                                                                                                                                             |
| 301    | APC alarm: nth-axis communication     | nth-axis (n=1 – 8) APC communication error. Failure in data transmission<br>Possible causes include a faulty APC, cable, or servo interface module.                                                                                  |
| 302    | APC alarm: nth-axis over time         | nth-axis (n=1 – 8) APC overtime error.<br>Failure in data transmission.<br>Possible causes include a faulty APC, cable, or servo interface module.                                                                                   |
| 303    | APC alarm: nth-axis framing           | nth-axis (n=1 – 8) APC framing error. Failure in data transmission.<br>Possible causes include a faulty APC, cable, or servo interface module.                                                                                       |
| 304    | APC alarm: nth-axis parity            | nth-axis (n=1 – 8) APC parity error.<br>Failure in data transmission.<br>Possible causes include a faulty APC, cable, or servo interface module.                                                                                     |
| 305    | APC alarm: nth-axis pulse error       | nth-axis (n=1 – 8) APC pulse error alarm.<br>APC alarm. APC or cable may be faulty.                                                                                                                                                  |
| 306    | APC alarm: nth-axis battery voltage 0 | nth-axis (n=1 – 8) APC battery voltage has decreased to a low level so that the data cannot be held.<br>APC alarm. Battery or cable may be faulty.                                                                                   |
| 307    | APC alarm: nth-axis battery low 1     | nth-axis (n=1 – 8) axis APC battery voltage reaches a level where the battery must be renewed.<br>APC alarm. Replace the battery.                                                                                                    |
| 308    | APC alarm: nth-axis battery low 2     | nth-axis (n=1 – 8) APC battery voltage has reached a level where the battery must be renewed (including when power is OFF).<br>APC alarm .Replace battery.                                                                           |
| 309    | APC ALARM : n AXIS ZRN IMPOSSIBL      | An attempt was made to perform reference position return without rotating the motor through one or more turns. Rotate the motor through one or more turns, turn off the power then on again, then perform reference position return. |



#### 4) Serial pulse coder (SPC) alarms

When either of the following alarms is issued, a possible cause is a faulty serial pulse coder or cable.

| Number | Message                         | Contents                                                                                                                              |
|--------|---------------------------------|---------------------------------------------------------------------------------------------------------------------------------------|
| 350    | SPC ALARM: n AXIS PULSE CODER   | The n axis (axis 1–8) pulse coder has a fault. Refer to diagnosis display No. 202 for details.                                        |
| 351    | SPC ALARM: n AXIS COMMUNICATION | n axis (axis 1–8) serial pulse coder communication error (data transmission fault)<br>Refer to diagnosis display No. 203 for details. |

- **The details of serial pulse coder alarm No.350**

The details of serial pulse coder alarm No. 350 (pulse coder alarm) are displayed in the diagnosis display (No. 202) as shown below.

|     | #7 | #6  | #5  | #4  | #3  | #2  | #1  | #0  |
|-----|----|-----|-----|-----|-----|-----|-----|-----|
| 202 |    | CSA | BLA | PHA | RCA | BZA | CKA | SPH |

**CSA** : The serial pulse coder is defective. Replace it.

**BLA** : The battery voltage is low. Replace the batteries. This alarm has nothing to do with alarm No. 350 (serial pulse coder alarm).

**SPH** : The serial pulse coder or feedback cable is defective. Replace the serial pulse coder or cable.

**RCA** : The serial pulse coder is defective. Replace it.

**BZA** : The pulse coder was supplied with power for the first time. Make sure that the batteries are connected.

Turn the power off, then turn it on again and perform a reference position return. This alarm has nothing to do with alarm No. 350 (serial pulse coder alarm).

**CKA** : The serial pulse coder is defective. Replace it.

**PHA** : The serial pulse coder or feedback cable is defective. replace the serial pulse coder or cable.

- **The details of serial pulse coder alarm No.351**

The details of serial pulse coder alarm No. 351 (communication alarm) are displayed in the diagnosis display (No. 203) as shown below.

|     | #7  | #6  | #5  | #4  | #3 | #2 | #1 | #0 |
|-----|-----|-----|-----|-----|----|----|----|----|
| 203 | DTE | CRC | STB | PRM |    |    |    |    |

**DTE** : The serial pulse coder encountered a communication error. The pulse coder, feedback cable, or feedback receiver circuit is defective. Replace the pulse coder, feedback cable, or NC-axis board

**CRC** : The serial pulse coder encountered a communication error. The pulse coder, feedback cable, or feedback receiver circuit is defective. Replace the pulse coder, feedback cable, or NC-axis board.

**STB** : the serial pulse coder encountered a communication error. The pulse coder, feedback cable, or feedback receiver circuit is defective.

Replace the pulse coder, feedback cable, or NC-axis board.

**PRM**: An invalid parameter was found. Alarm No. 417 (invalid servo parameter) is also issued.

### 5) Servo alarms

| Number | Message                                          | Contents                                                                                                                                                                                                                                                                                                                                                                                                                                                                                                                                                                                                                                                                                                                                                                                                                                                                                                                                                                                                                                                             |
|--------|--------------------------------------------------|----------------------------------------------------------------------------------------------------------------------------------------------------------------------------------------------------------------------------------------------------------------------------------------------------------------------------------------------------------------------------------------------------------------------------------------------------------------------------------------------------------------------------------------------------------------------------------------------------------------------------------------------------------------------------------------------------------------------------------------------------------------------------------------------------------------------------------------------------------------------------------------------------------------------------------------------------------------------------------------------------------------------------------------------------------------------|
| 400    | SERVO ALARM: n-TH AXIS OVER-LOAD                 | The n-th axis (axis 1-8) overload signal is on. Refer to diagnosis display No. 201 for details.                                                                                                                                                                                                                                                                                                                                                                                                                                                                                                                                                                                                                                                                                                                                                                                                                                                                                                                                                                      |
| 401    | SERVO ALARM: n-TH AXIS VRDY OFF                  | The n-th axis (axis 1-8) servo amplifier READY signal (DRDY) went off.                                                                                                                                                                                                                                                                                                                                                                                                                                                                                                                                                                                                                                                                                                                                                                                                                                                                                                                                                                                               |
| 404    | SERVO ALARM: n-TH AXIS VRDY ON                   | Even though the n-th axis (axis 1-8) READY signal (MCON) went off, the servo amplifier READY signal (DRDY) is still on. Or, when the power was turned on, DRDY went on even though MCON was off. Check that the servo interface module and servo amp are connected.                                                                                                                                                                                                                                                                                                                                                                                                                                                                                                                                                                                                                                                                                                                                                                                                  |
| 405    | SERVO ALARM: (ZERO POINT RETURN FAULT)           | Position control system fault. Due to an NC or servo system fault in the reference position return, there is the possibility that reference position return could not be executed correctly. Try again from the manual reference position return.                                                                                                                                                                                                                                                                                                                                                                                                                                                                                                                                                                                                                                                                                                                                                                                                                    |
| 407    | SERVO ALARM: EXCESS ERROR                        | The difference in synchronous axis position deviation exceeded the set value.                                                                                                                                                                                                                                                                                                                                                                                                                                                                                                                                                                                                                                                                                                                                                                                                                                                                                                                                                                                        |
| 409    | TORQUEALM' : EXCESS ERROR                        | An abnormal load on the servo motor was detected. Alternatively, an abnormal load on the spindle motor was detected in Cs mode.                                                                                                                                                                                                                                                                                                                                                                                                                                                                                                                                                                                                                                                                                                                                                                                                                                                                                                                                      |
| 410    | SERVO ALARM: n-TH AXIS - EXCESS ERROR            | The position deviation value when the n-th axis (axis 1-8) stops is larger than the set value.<br>Note) Limit value must be set to parameter No.1829 for each axis.                                                                                                                                                                                                                                                                                                                                                                                                                                                                                                                                                                                                                                                                                                                                                                                                                                                                                                  |
| 411    | SERVO ALARM: n-TH AXIS - EXCESS ERROR            | The position deviation value when the n-th axis (axis 1-8) moves is larger than the set value.<br>Note) Limit value must be set to parameter No.1828 for each axis.                                                                                                                                                                                                                                                                                                                                                                                                                                                                                                                                                                                                                                                                                                                                                                                                                                                                                                  |
| 413    | SERVO ALARM: n-th AXIS - LSI OVERFLOW            | The contents of the error register for the n-th axis (axis 1-8) are beyond the range of $-2^{31}$ to $2^{31}$ . This error usually occurs as the result of an improperly set parameters.                                                                                                                                                                                                                                                                                                                                                                                                                                                                                                                                                                                                                                                                                                                                                                                                                                                                             |
| 414    | SERVO ALARM: n-TH AXIS - DETECTION RELATED ERROR | N-th axis (axis 1-8) digital servo system fault. Refer to diagnosis display No. 200 and No.204 for details.                                                                                                                                                                                                                                                                                                                                                                                                                                                                                                                                                                                                                                                                                                                                                                                                                                                                                                                                                          |
| 415    | SERVO ALARM: n-TH AXIS - EXCESS SHIFT            | A speed higher than 511875 units/s was attempted to be set in the n-th axis (axis 1-8). This error occurs as the result of improperly set CMR.                                                                                                                                                                                                                                                                                                                                                                                                                                                                                                                                                                                                                                                                                                                                                                                                                                                                                                                       |
| 416    | SERVO ALARM: n-TH AXIS - DISCONNECTION           | Position detection system fault in the n-th axis (axis 1-8) pulse coder (disconnection alarm). Refer to diagnosis display No. 201 for details.                                                                                                                                                                                                                                                                                                                                                                                                                                                                                                                                                                                                                                                                                                                                                                                                                                                                                                                       |
| 417    | SERVO ALARM: n-TH AXIS - PARAMETER INCORRECT     | This alarm occurs when the n-th axis (axis 1-8) is in one of the conditions listed below. (Digital servo system alarm)<br><ol style="list-style-type: none"> <li>1) The value set in Parameter No. 2020 (motor form) is out of the specified limit.</li> <li>2) A proper value (111 or -111) is not set in parameter No.2022 (motor revolution direction).</li> <li>3) Illegal data (a value below 0, etc.) was set in parameter No. 2023 (number of speed feedback pulses per motor revolution).</li> <li>4) Illegal data (a value below 0, etc.) was set in parameter No. 2024 (number of position feedback pulses per motor revolution).</li> <li>5) Parameters No. 2084 and No. 2085 (flexible field gear rate) have not been set.</li> <li>6) A value outside the limit of {1 to the number of control axes} or a non-continuous value (Parameter 1023 (servo axis number) contains a value out of the range from 1 to the number of axes, or an isolated value (for example, 4 not preceded by 3).was set in parameter No. 1023 (servo axisnumber).</li> </ol> |

| Number | Message                      | Contents                                                                                                                                                                                                                                |
|--------|------------------------------|-----------------------------------------------------------------------------------------------------------------------------------------------------------------------------------------------------------------------------------------|
| 420    | SYNC TORQUE' : EXCESS ERROR  | When simple synchronous control is applied, the torque command difference between the master and slave axes exceeded the value set in parameter No. 2031.                                                                               |
| 421    | EXCESS ER(D)' : EXCESS ERROR | While the dual position feedback function is being applied, an excessive difference was detected between a semi-closed loop error and closed loop error. Check the dual position conversion factor set in parameter Nos. 2078 and 2079. |

● **Details of servo alarm No.414**

The details of servo alarm No. 414 are displayed in the diagnosis display (No. 200 and No.204) as shown below.

|     | #7  | #6 | #5  | #4  | #3  | #2  | #1  | #0  |
|-----|-----|----|-----|-----|-----|-----|-----|-----|
| 200 | OVL | LV | OVC | HCA | HVA | DCA | FBA | OFA |

- OVL** : An overload alarm is being generated.  
(This bit causes servo alarm No. 400. The details are indicated in diagnostic data No.201).
- LV** : A low voltage alarm is being generated in servo amp.  
Check LED.
- OVC** : A overcurrent alarm is being generated inside of digital servo.
- HCA** : An abnormal current alarm is being generated in servo amp.  
Check LED.
- HVA** : An overvoltage alarm is being generated in servo amp.  
Check LED.
- DCA** : A regenerative discharge circuit alarm is being generated in servo amp.  
Check LED.
- FBA** : A disconnection alarm is being generated.  
(This bit causes servo alarm No.416.The details are indicated in diagnostic data No. 201)
- OFA** : An overflow alarm is being generated inside of digital servo.

|     | #7 | #6  | #5  | #4  | #3  | #2 | #1 | #0 |
|-----|----|-----|-----|-----|-----|----|----|----|
| 204 |    | OFS | MCC | LDA | PMS |    |    |    |

- OFS** : A current conversion error has occurred in the digital servo.
- MCC** : A magnetic contactor contact in the servo amplifier has welded.
- LDA** : The LED indicates that serial pulse coder C is defective
- PMS** : A feedback pulse error has occurred because the feedback cable is defective.

- **Details of servo alarms No. 400 and No.416**

The details of servo alarms No. 400 and No. 416 are displayed in the diagnosis display (No. 201) as shown below.

|     |     |    |    |     |    |    |    |    |
|-----|-----|----|----|-----|----|----|----|----|
|     | #7  | #6 | #5 | #4  | #3 | #2 | #1 | #0 |
| 201 | ALD |    |    | EXP |    |    |    |    |

When OVL equal 1 in diagnostic data No.200  
(servo alarm No. 400 is being generated):

**ALD** 0 : Motor overheating  
1 : Amplifier overheating

When FBAL equal 1 in diagnostic data No.200  
(servo alarm No. 416 is being generated):

| ALD | EXP | Alarm details                                             |
|-----|-----|-----------------------------------------------------------|
| 1   | 0   | Built-in pulse coder disconnection (hardware)             |
| 1   | 1   | Separately installed pulse coder disconnection (hardware) |
| 0   | 0   | Pulse coder is not connected due to software.             |

## 6) Over travel alarms

| Number | Message          | Contents                                                                                                                                                                                                 |
|--------|------------------|----------------------------------------------------------------------------------------------------------------------------------------------------------------------------------------------------------|
| 500    | OVER TRAVEL : +n | Exceeded the n-th axis (axis 1-8) + side stored stroke limit I. (Parameter No.1320 or 1326 <b>Notes</b> )                                                                                                |
| 501    | OVER TRAVEL : -n | Exceeded the n-th axis (axis 1-8) - side stored stroke limit I. (Parameter No.1321 or 1327 <b>Notes</b> )                                                                                                |
| 502    | OVER TRAVEL : +n | Exceeded the n-th axis (axis 1-8) + side stored stroke limit II. (Parameter No.1322 )                                                                                                                    |
| 503    | OVER TRAVEL : -n | Exceeded the n-th axis (axis 1-8) - side stored stroke limit II. (Parameter No.1323)                                                                                                                     |
| 504    | OVER TRAVEL : +n | Exceeded the n-th axis (axis 1-8) - side stored stroke limit III. (Parameter No.1324)                                                                                                                    |
| 505    | OVER TRAVEL : -n | Exceeded the n-th axis (axis 1-8) - side stored stroke limit III. (Parameter No.1325)                                                                                                                    |
| 506    | OVER TRAVEL : +n | Exceeded the n-th axis (axis 1-8) + side hardware OT.                                                                                                                                                    |
| 507    | OVER TRAVEL : -n | Exceeded the n-th axis (axis 1-8) - side hardware OT.                                                                                                                                                    |
| 510    | OVER TRAVEL : +n | A stroke limit check, made before starting movement, found that the end point of a block falls within the plus (+) side inhibited area along the n-axis defined by a stroke limit. Correct the program.  |
| 511    | OVER TRAVEL : -n | A stroke limit check, made before starting movement, found that the end point of a block falls within the minus (-) side inhibited area along the N-axis defined by a stroke limit. Correct the program. |

### NOTE

Parameters 1326 and 1327 are effective when EXLM (stroke limit switch signal) is on.

## 7) Overheat alarms

| Number | Message                | Contents                                                                                                                                                                                                                      |
|--------|------------------------|-------------------------------------------------------------------------------------------------------------------------------------------------------------------------------------------------------------------------------|
| 700    | OVERHEAT: CONTROL UNIT | Control unit overheat<br>Check that the fan motor operates normally, and clean the air filter.                                                                                                                                |
| 701    | OVERHEAT: FAN MOTOR    | The fan motor on the top of the cabinet for the control unit is overheated.<br>Check the operation of the fan motor and replace the motor if necessary.                                                                       |
| 704    | OVERHEAT: SPINDLE      | Spindle overheat in the spindle fluctuation detection<br>1) If the cutting load is heavy, relieve the cutting condition.<br>2) Check whether the cutting tool is share.<br>3) Another possible cause is a faulty spindle amp. |

## 8) Rigid tapping alarm

| Number | Message                        | Contents                                                                                            |
|--------|--------------------------------|-----------------------------------------------------------------------------------------------------|
| 740    | RIGID TAP ALARM : EXCESS ERROR | During rigid tapping, the position deviation of the spindle in the stop state exceeded the setting. |
| 741    | RIGID TAP ALARM : EXCESS ERROR | During rigid tapping, the position deviation of the spindle in the stop state exceeded the setting. |
| 742    | RIGID TAP ALARM : LSI OVERFLOW | During rigid tapping, an LSI overflow occurred on the spindle side.                                 |

## 9) Spindle alarms

| Number | Message                               | Contents                                                                                                                                                                                                                                                                                                                                                                                                                                                                                                                                                                                                                                                                                                                                                                                                                                                             |
|--------|---------------------------------------|----------------------------------------------------------------------------------------------------------------------------------------------------------------------------------------------------------------------------------------------------------------------------------------------------------------------------------------------------------------------------------------------------------------------------------------------------------------------------------------------------------------------------------------------------------------------------------------------------------------------------------------------------------------------------------------------------------------------------------------------------------------------------------------------------------------------------------------------------------------------|
| 749    | S-SPINDLE LSI ERROR                   | A communication error occurred for the serial spindle. The cause may be the disconnection of a cable or the interruption of the power to the spindle amplifier.<br><br>(Note) Unlike spindle alarm No. 750, this alarm occurs when a serial communication alarm is detected after the spindle amplifier is normally activated.                                                                                                                                                                                                                                                                                                                                                                                                                                                                                                                                       |
| 750    | SPINDLE SERIAL LINK START FAULT       | This alarm is generated when the spindle control unit is not ready for starting correctly when the power is turned on in the system with the serial spindle.<br>The four reasons can be considered as follows:<br>1) An improperly connected cable, or the spindle control unit's power is OFF.<br>2) When the NC power was turned on under alarm conditions other than SU-01 or AL-24 which are shown on the LED display of the spindle control unit.<br>In this case, turn the spindle amplifier power off once and perform startup again.<br>3) Other reasons (improper combination of hardware)<br>This alarm does not occur after the system including the spindle control unit is activated.<br>4) The second spindle (when SP2, bit 4 of parameter No. 3701, is 1) is in one of the above conditions 1) to 3).<br>See diagnostic display No. 409 for details. |
| 751    | FIRST SPINDLE ALARM DETECTION (AL-XX) | This alarm indicates in the NC that an alarm is generated in the spindle unit of the system with the serial spindle. The alarm is displayed in form AL-XX (XX is a number). Refer to <b>(11) Alarms displayed on spindle servo unit</b> . The alarm number XX is the number indicated on the spindle amplifier. The CNC holds this number and displays on the screen.                                                                                                                                                                                                                                                                                                                                                                                                                                                                                                |

| Number | Message                                | Contents                                                                                                                                                                                                                                                                                                        |
|--------|----------------------------------------|-----------------------------------------------------------------------------------------------------------------------------------------------------------------------------------------------------------------------------------------------------------------------------------------------------------------|
| 752    | FIRST SPINDLE MODE CHANGE FAULT        | This alarm is generated if the system does not properly terminate a mode change. The modes include the Cs contouring, spindle positioning, rigid tapping, and spindle control modes. The alarm is activated if the spindle control unit does not respond correctly to the mode change command issued by the NC. |
| 754    | SPINDLE-1 ABNORMAL TORQUE ALM          | An abnormal load on the first spindle motor was detected.                                                                                                                                                                                                                                                       |
| 761    | SECOND SPINDLE ALARM DETECTION (AL-XX) | Refer to spindle alarm No. 751. (For 2nd axis)                                                                                                                                                                                                                                                                  |
| 762    | SECOND SPINDLE MODE CHANGE FAULT       | Refer to spindle alarm No. 752.(For 2nd axis)                                                                                                                                                                                                                                                                   |
| 764    | SPINDLE-2 ABNORMAL TORQUE ALM          | Same as for alarm No. 754 (for the second spindle)                                                                                                                                                                                                                                                              |
| 771    | SPINDLE-3 ALARM DETECT (AL-XX)         | Same as for alarm No. 751 (for the third spindle)                                                                                                                                                                                                                                                               |
| 772    | SPINDLE-3 MODE CHANGE ERROR            | Same as for alarm No. 752 (for the third spindle)                                                                                                                                                                                                                                                               |
| 774    | SPINDLE-3 ABNORMAL TORQUE ALM          | Same as for alarm No. 754 (for the third spindle)                                                                                                                                                                                                                                                               |

● **The details of spindle alarm No.750**

The details of spindle alarm No. 750 are displayed in the diagnosis display (No. 409) as shown below.

|     | #7 | #6 | #5 | #4 | #3  | #2  | #1  | #0  |
|-----|----|----|----|----|-----|-----|-----|-----|
| 409 |    |    |    |    | SPE | S2E | S1E | SHE |

- SPE** **0** : In the spindle serial control, the serial spindle parameters fulfill the spindle unit startup conditions.  
**1** : In the spindle serial control, the serial spindle parameters do not fulfill the spindle unit startup conditions.
- S2E** **0** : The second spindle is normal during the spindle serial control startup.  
**1** : The second spindle was detected to have a fault during the spindle serial control startup.
- S1E** **0** : The first spindle is normal during the spindle serial control startup.  
**1** : The first spindle was detected to have a fault during the spindle axis serial control startup.
- SHE** **0** : The serial communications module in the CNC is normal.  
**1** : The serial communications module in the CNC was detected to have a fault.

**10) System alarms**

(These alarms cannot be reset with reset key.)

| Number | Message                        | Contents                                                                                                                                                                                                                                                                                                                                             |
|--------|--------------------------------|------------------------------------------------------------------------------------------------------------------------------------------------------------------------------------------------------------------------------------------------------------------------------------------------------------------------------------------------------|
| 900    | ROM PARITY                     | ROM parity error (CNC/OMM/Servo)<br>Rewrite the flash ROM with the indicated ROM number.                                                                                                                                                                                                                                                             |
| 910    | RAM PARITY : (4N)              | RAM parity error in the tape memory RAM module. Clear the memory or replace the module.<br>After this operation, reset all data including the parameters.                                                                                                                                                                                            |
| 911    | RAM PARITY: (4N+1)             | RAM parity error in the tape memory RAM module. Clear the memory or replace the module.<br>After this operation, reset all data including the parameters.                                                                                                                                                                                            |
| 912    | RAM PARITY: (4N+2)             | RAM parity error in the tape memory RAM module. Clear the memory or replace the module.<br>After this operation, reset all data including the parameters.                                                                                                                                                                                            |
| 913    | RAM PARITY : (4N+3)            | RAM parity error in the tape memory RAM module. Clear the memory or replace the module.<br>After this operation, reset all data including the parameters.                                                                                                                                                                                            |
| 914    | ADDITIONAL SRAM PARITY (2N)    | RAM parity error for part program storage RAM or additional SRAM. Clear memory or replace the main CPU board or additional SRAM. Then, re-specify all data including parameters.                                                                                                                                                                     |
| 915    | ADDITIONAL SRAM PARITY (2N+1)  |                                                                                                                                                                                                                                                                                                                                                      |
| 916    | DRAM PARITY                    | RAM parity error in the DRAM module. Replace the DRAM module.                                                                                                                                                                                                                                                                                        |
| 920    | SERVO ALARM (1/2 AXIS)         | Servo alarm (1st or 2nd axis). A watchdog alarm or a RAM parity error in the servo module occurred.<br>Replace the servo control module on the main CPU board.                                                                                                                                                                                       |
| 921    | SERVO ALARM (3/4 AXIS)         | Servo alarm (3rd or 4th axis). A watchdog alarm or a RAM parity error in the servo module occurred.<br>Replace the servo control module on the main CPU board.                                                                                                                                                                                       |
| 922    | SERVO ALARM (5/6 AXIS)         | Servo alarm (5th to 8th axis). A watchdog alarm or a RAM parity error in the servo module occurred.<br>Replace the servo control module on the option 2 board.                                                                                                                                                                                       |
| 926    | SERVO ALARM (1/2/3/4/5/6 AXIS) | Servo alarm (first to sixth axis). A RAM parity error in the servo module or a watchdog alarm has occurred. Replace the servo control module on the main CPU board.                                                                                                                                                                                  |
| 930    | CPU INTERRUPT                  | CPU error (abnormal interrupt)<br>The main CPU board is faulty.                                                                                                                                                                                                                                                                                      |
| 950    | PMC SYSTEM ALARM               | Fault occurred in the PMC. The PMC control module on the main CPU board or option 3 board may be faulty.                                                                                                                                                                                                                                             |
| 951    | PMC-RC WATCH DOG ALARM         | Fault occurred in the PMC-RC (watchdog alarm).Option 3 board may be faulty.                                                                                                                                                                                                                                                                          |
| 970    | NMI OCCURRED IN BOC            | RAM parity error or NMI occurred in the PMC-RB or PMC-RA2 module.                                                                                                                                                                                                                                                                                    |
| 971    | NMI OCCURRED IN SLC            | An alarm condition occurred in the interface with an I/O unit. For PMC-RA and PMC-RB, check that the PMC control module on the main CPU board is conneted to the I/O unit securely. For PMC-RC, check that the PMC control module on the option 3 board is connected to the I/O unit is supplied with power and that the interface module is intact. |
| 972    | NMI OCCURRED IN OTHER MODULE   | NMI occurred in a board other than the main CPU board.                                                                                                                                                                                                                                                                                               |
| 973    | NON MASK INTERRUPT             | NMI occurred for an unknown reason.                                                                                                                                                                                                                                                                                                                  |
| 974    | F-BUS ERROR                    | BUS error of FANUC BUS.<br>The main CPU board or option 1 to 3 boards may be faulty.                                                                                                                                                                                                                                                                 |
| 975    | BUS ERROR (MAIN)               | Main CPU board bus error.<br>The main CPU board may be faulty.                                                                                                                                                                                                                                                                                       |

### 11) Alarms Displayed on spindle Servo Unit

| Alarm No.   | Meaning                                            | Description                                                                                                  | Remedy                                                                          |
|-------------|----------------------------------------------------|--------------------------------------------------------------------------------------------------------------|---------------------------------------------------------------------------------|
| "A" display | Program ROM abnormality (not installed)            | Detects that control program is not started (due to program ROM not installed, etc.)                         | Install normal program ROM                                                      |
| AL-01       | Motor overheat                                     | Detects motor speed exceeding specified speed excessively.                                                   | Check load status. Cool motor then reset alarm.                                 |
| AL-02       | Excessive speed deviation                          | Detects motor speed exceeding specified speed excessively.                                                   | Check load status. Reset alarm.                                                 |
| AL-03       | DC link section fuse blown                         | Detects that fuse F4 in DC link section is blown (models 30S and 40S).                                       | Check power transistors, and so forth. Replace fuse.                            |
| AL-04       | Input fuse blown. Input power open phase.          | Detects blown fuse (F1 to F3), open phase or momentary failure of power (models 30S and 40S).                | Replace fuse. Check open phase and power supply regenerative circuit operation. |
| AL-05       | Control power supply fuse blown                    | Detects that control power supply fuse AF2 or AF3 is blown (models 30S and 40S).                             | Check for control power supply short circuit. Replace fuse.                     |
| AL-07       | Excessive speed                                    | Detects that motor rotation has exceeded 115% of its rated speed.                                            | Reset alarm.                                                                    |
| AL-08       | High input voltage                                 | Detects that switch is flipped to 200 VAC when input voltage is 230 VAC or higher (models 30S and 40S).      | Flip switch to 230 VAC.                                                         |
| AL-09       | Excessive load on main circuit section             | Detects abnormal temperature rise of power transistor radiator.                                              | Cool radiator then reset alarm.                                                 |
| AL-10       | Low input voltage                                  | Detects drop in input power supply voltage.                                                                  | Remove cause, then reset alarm.                                                 |
| AL-11       | Overvoltage in DC link section                     | Detects abnormally high direct current power supply voltage in power circuit section.                        | Remove cause, then reset alarm.                                                 |
| AL-12       | Overcurrent in DC link section                     | Detects flow of abnormally large current in direct current section of power circuit                          | Remove cause, then reset alarm.                                                 |
| AL-13       | CPU internal data memory abnormality               | Detects abnormality in CPU internal data memory. This check is made only when power is turned on.            | Remove cause, then reset alarm.                                                 |
| AL-15       | Spindle switch/output switch alarm                 | Detects incorrect switch sequence in spindle switch/output switch operation.                                 | Check sequence.                                                                 |
| AL-16       | RAM abnormality                                    | Detects abnormality in RAM for external data. This check is made only when power is turned on.               | Remove cause, then reset alarm.                                                 |
| AL-18       | Program ROM sum check error                        | Detects program ROM data error. This check is made only when power is turned on.                             | Remove cause, then reset alarm.                                                 |
| AL-19       | Excessive U phase current detection circuit offset | Detects excessive U phase current detection circuit offset. This check is made only when power is turned on. | Remove cause, then reset alarm.                                                 |
| AL-20       | Excessive V phase current detection circuit offset | Detects excessive V phase current detection circuit offset. This check is made only when power is turned on. | Remove cause, then reset alarm.                                                 |
| AL-24       | Serial transfer data error                         | Detects serial transfer data error (such as NC power supply turned off, etc.)                                | Remove cause, then reset alarm.                                                 |
| AL-25       | Serial data transfer stopped                       | Detects that serial data transfer has stopped.                                                               | Remove cause, then reset alarm.                                                 |



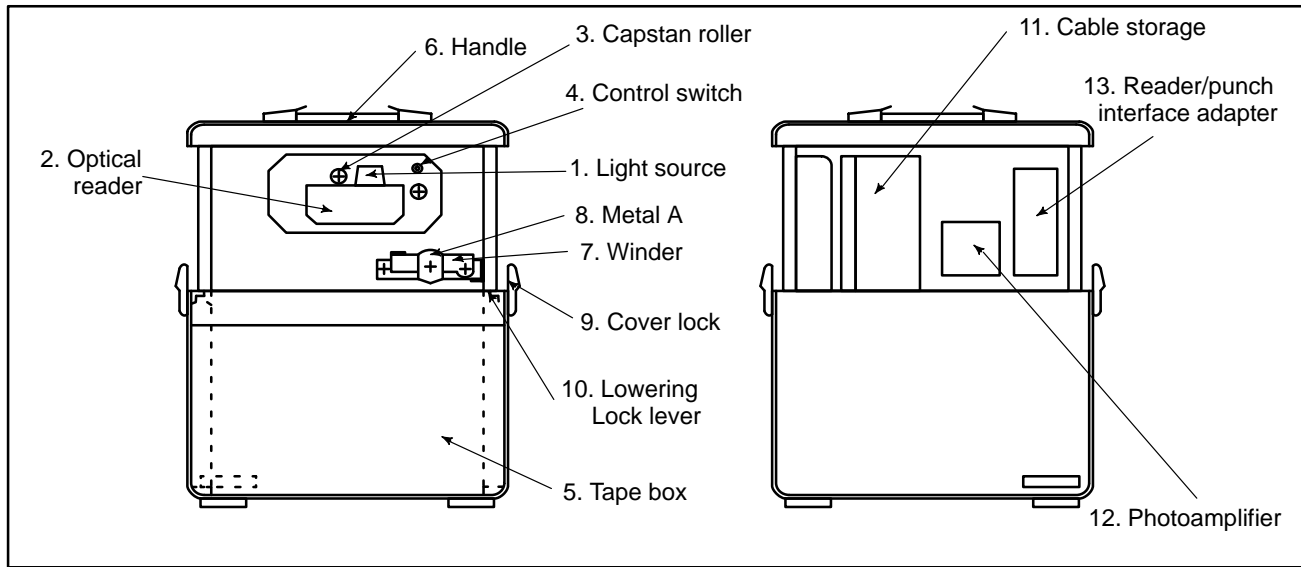
| Alarm No. | Meaning                                                                                                       | Description                                                                                                                                                                                                 | Remedy                                                                              |
|-----------|---------------------------------------------------------------------------------------------------------------|-------------------------------------------------------------------------------------------------------------------------------------------------------------------------------------------------------------|-------------------------------------------------------------------------------------|
| AL-26     | Disconnection of speed detection signal for Cs contouring control                                             | Detects abnormality in position coder signal (such as unconnected cable and parameter setting error).                                                                                                       | Remove cause, then reset alarm.                                                     |
| AL-27     | Position coder signal disconnection                                                                           | Detects abnormality in position coder signal (such as unconnected cable and adjustment error).                                                                                                              | Remove cause, then reset alarm.                                                     |
| AL-28     | Disconnection of position detection signal for Cs contouring control                                          | Detects abnormality in position detection signal for Cs contouring control (such as unconnected cable and adjustment error).                                                                                | Remove cause, then reset alarm.                                                     |
| AL-29     | Short-time overload                                                                                           | Detects that overload has been continuously applied for some period of time (such as restraining motor shaft in positioning).                                                                               | Remove cause, then reset alarm.                                                     |
| AL-30     | Input circuit overcurrent                                                                                     | Detects overcurrent flowing in input circuit.                                                                                                                                                               | Remove cause, then reset alarm.                                                     |
| AL-31     | Speed detection signal disconnection motor restraint alarm or motor is clamped.                               | Detects that motor cannot rotate at specified speed or it is detected that the motor is clamped. (but rotates at very slow speed or has stopped). (This includes checking of speed detection signal cable.) | Remove cause, then reset alarm.                                                     |
| AL-32     | Abnormality in RAM internal to LSI for serial data transfer. This check is made only when power is turned on. | Detects abnormality in RAM internal to LSI for serial data transfer. This check is made only when power is turned on.                                                                                       | Remove cause, then reset alarm.                                                     |
| AL-33     | Insufficient DC link section charging                                                                         | Detects insufficient charging of direct current power supply voltage in power circuit section when magnetic contactor in amplifier is turned on (such as open phase and defective charging resistor).       | Remove cause, then reset alarm.                                                     |
| AL-34     | Parameter data setting beyond allowable range of values                                                       | Detects parameter data set beyond allowable range of values.                                                                                                                                                | Set correct data.                                                                   |
| AL-35     | Excessive gear ratio data setting                                                                             | Detects gear ratio data set beyond allowable range of values.                                                                                                                                               | Set correct data.                                                                   |
| AL-36     | Error counter over flow                                                                                       | Detects error counter overflow.                                                                                                                                                                             | Correct cause, then reset alarm.                                                    |
| AL-37     | Speed detector parameter setting error                                                                        | Detects incorrect setting of parameter for number of speed detection pulses.                                                                                                                                | Set correct data.                                                                   |
| AL-39     | Alarm for indicating failure in detecting 1-rotation signal for Cs contouring control                         | Detects 1-rotation signal detection failure in Cs contouring control.                                                                                                                                       | Make 1-rotation signal adjustment.<br>Check cable shield status.                    |
| AL-40     | Alarm for indicating 1-rotation signal for Cs contouring control not detected                                 | Detects that 1-rotation signal has not occurred in Cs contouring control.                                                                                                                                   | Make 1-rotation signal adjustment.                                                  |
| AL-41     | Alarm for indicating failure in detecting position coder 1-rotation signal.                                   | Detects failure in detecting position coder 1-rotation signal.                                                                                                                                              | Make signal adjustment for signal conversion circuit.<br>Check cable shield status. |
| AL-42     | Alarm for indicating position coder 1-rotation signal not detected                                            | Detects that position coder 1-rotation signal has not issued.                                                                                                                                               | Make 1-rotation signal adjustment for signal conversion circuit.                    |
| AL-43     | Alarm for indicating disconnection of position coder signal for differential speed mode                       | Detects that main spindle position coder signal used for differential speed mode is not connected yet (or is disconnected).                                                                                 | Check that main spindle position coder signal is connected to connector CN12.       |

| Alarm No. | Meaning                                                                                                 | Description                                                                                                                                | Remedy                                                                                                                             |
|-----------|---------------------------------------------------------------------------------------------------------|--------------------------------------------------------------------------------------------------------------------------------------------|------------------------------------------------------------------------------------------------------------------------------------|
| AL-46     | Alarm for indicating failure in detecting position coder 1-rotation signal in thread cutting operation. | Detects failure in detecting position coder 1-rotation signal in thread cutting operation.                                                 | Make 1-rotation signal adjustment for signal conversion circuit<br>Check cable shield status.                                      |
| AL-47     | Position coder signal abnormality                                                                       | Detects incorrect position coder signal count operation.                                                                                   | Make signal adjustment for signal conversion circuit.<br>Check cable shield status.                                                |
| AL-48     | Position coder 1-rotation signal abnormality                                                            | Detects that occurrence of position coder 1-rotation signal has stopped.                                                                   | Make 1-rotation signal adjustment for signal conversion circuit.                                                                   |
| AL-49     | The converted differential speed is too high.                                                           | Detects that speed of other spindle converted to speed of local spindle has exceeded allowable limit in differential mode.                 | Check the position coder state of the other side.                                                                                  |
| AL-50     | Excessive speed command calculation value in spindle synchronization control                            | Detects that speed command calculation value exceeded allowable range in spindle synchronization control.                                  | Check parameters such as a position gain.                                                                                          |
| AL-51     | Undervoltage at DC link section                                                                         | Detects that DC power supply voltage of power circuit has dropped (due to momentary power failure or loose contact of magnetic contactor). | Remove cause, then reset alarm.                                                                                                    |
| AL-52     | ITP signal abnormality I                                                                                | Detects abnormality in synchronization signal (ITP signal) with CNC (such as loss of ITP signal).                                          | Remove cause, then reset alarm.                                                                                                    |
| AL-53     | ITP signal abnormality II                                                                               | Detects abnormality in synchronization signal (ITP signal) with CNC (such as loss of ITP signal).                                          | Remove cause, then reset alarm.                                                                                                    |
| AL-54     | Overload current alarm                                                                                  | Detects that excessive current flowed in motor for long time.                                                                              | Check if overload operation or frequent acceleration/deceleration is performed.                                                    |
| AL-55     | Power line abnormality in spindle switching/output switching                                            | Detects that switch request signal does not match power line status check signal.                                                          | Check operation of magnetic contractor for power line switching.<br>Check if power line status check signal is processed normally. |
| AL-56     | Stopped cooling fan in the unit                                                                         | The cooling fan of the control circuit section has stopped.                                                                                | Check the operation of the cooling fan, then replace it.                                                                           |
| AL-57     | Excessive deceleration power                                                                            | A current has flowed into the regenerative resistor exceeding the specified duration.                                                      | Check the selection of the regenerative resistor.<br>Alternatively, check whether the cooling fan is stopped.                      |
| AL-58     | Over load on PSM main circuit                                                                           | The heat sink for the main circuit has become too hot. (Cooling fan failure, dirty cooling fan, or overloaded operation)                   | Eliminate the cause, then reset the alarm.                                                                                         |
| AL-59     | Stopped PSM cooling fan                                                                                 | The cooling fan of the control circuit section has stopped.                                                                                | Check the operation of the cooling fan, then replace it.                                                                           |

# H OPERATION OF PORTABLE TAPE READER

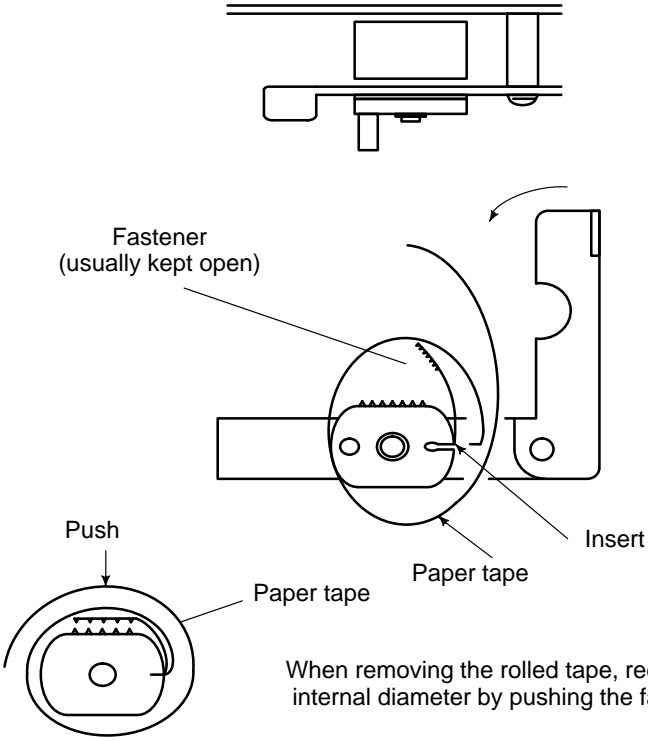
Portable tape reader is the device which inputs the NC program and the data on the paper tape to CNC.

• **Names and descriptions of each section**



**Table 1 Description of Each Section**

| No. | Name                       | Descriptions                                                                                                                                                                                                                                                                                                                                                                                                                                                                                                                                                                  |
|-----|----------------------------|-------------------------------------------------------------------------------------------------------------------------------------------------------------------------------------------------------------------------------------------------------------------------------------------------------------------------------------------------------------------------------------------------------------------------------------------------------------------------------------------------------------------------------------------------------------------------------|
| 1   | Light Sources              | An LED (Light emitting diode) is mounted for each channel and for the feed hole (9 diodes in total). A built-in Stop Shoe functions to decelerate the tape. The light source is attracted to the optical reader by a magnet so that the tape will be held in the correct position. This unit can be opened upward, by turning the tape reader control switch to the RELEASE position (this turns off the magnet).                                                                                                                                                             |
| 2   | Optical Reader             | Reads data punched on the tape, through a glass window. Dust or scratches on the glass window can result in reading errors. Keep this window clean.                                                                                                                                                                                                                                                                                                                                                                                                                           |
| 3   | Capstan Roller             | Controls the feeding of tape as specified by the control unit.                                                                                                                                                                                                                                                                                                                                                                                                                                                                                                                |
| 4   | Tape Reader Control Switch | A 3-position switch used to control the Tape Reader.<br><b>RELEASE</b> ----- The tape is allowed to be free, or used to open the lightsource. When loading or unloading the tape, select this position.<br><b>AUTO</b> ----- The tape is set to fixed position by the Stop Shoe. The feed and stop of the tape is controlled by the CNC. To input data from tape, the Light Source must be closed and this position must be selected.<br><b>MANUAL</b> ----- The tape can be fed in the forward reading direction. if another position is selected, the tape feed is stopped. |
| 5   | Tape Box                   | A Tape Box is located below the Tape Reader. A belt used to draw out a paper tape is located inside the box. The paper tape can easily be pulled out using this belt. The tape box accomodates 15 meters of tape.                                                                                                                                                                                                                                                                                                                                                             |
| 6   | Handle                     | Used to carry the tape reader.                                                                                                                                                                                                                                                                                                                                                                                                                                                                                                                                                |

| No. | Name                           | Descriptions                                                                                                                                                                                                                                                                                                                                                                                                                                                                                                                                                                                                                         |
|-----|--------------------------------|--------------------------------------------------------------------------------------------------------------------------------------------------------------------------------------------------------------------------------------------------------------------------------------------------------------------------------------------------------------------------------------------------------------------------------------------------------------------------------------------------------------------------------------------------------------------------------------------------------------------------------------|
| 7   | Winder                         | Used to advance or rewind the tape.                                                                                                                                                                                                                                                                                                                                                                                                                                                                                                                                                                                                  |
| 8   | Metal A                        |  <p>The diagram illustrates the Metal A mechanism. It shows a cross-section of a cylindrical component with a fastener (usually kept open) and an insert. Paper tape is shown being inserted into the mechanism. A push action is indicated to reduce the internal diameter. Text below the diagram states: "When removing the rolled tape, reduce the internal diameter by pushing the fastener."</p>                                                                                                                                            |
| 9   | Cover lock                     | Be sure to use the lock for fastening the cover before carrying the tape reader.                                                                                                                                                                                                                                                                                                                                                                                                                                                                                                                                                     |
| 10  | Lowering lock lever            | <p>When the tape reader is raised, the latch mechanism is activated to fix the tape reader. Thus, the tape reader is not lowered. The latch is locked with the lowering lock lever. The latch is therefore not unlocked even when the tape reader is raised with the handle.</p> <p>When the latch is locked, the lever is horizontal. To store the tape reader in the box, push the lever to release the lock, then raise the tape reader with the handle to unlock the latch.</p> <p>When the latch is unlocked, the tape reader can be stored in the box.</p> <p>When storing the tape reader, secure it with the cover lock.</p> |
| 11  | Cable storage                  | Used to store rolled power and signal cables. The cable length is 1.5 m.                                                                                                                                                                                                                                                                                                                                                                                                                                                                                                                                                             |
| 12  | Photoamplifier                 | For the tape reader                                                                                                                                                                                                                                                                                                                                                                                                                                                                                                                                                                                                                  |
| 13  | Reader/punch interface adapter | 200 VAC input and 5 VDC output power and reader/punch interface adapter PCB                                                                                                                                                                                                                                                                                                                                                                                                                                                                                                                                                          |

### Procedure for Operating the Portable Tape Reader

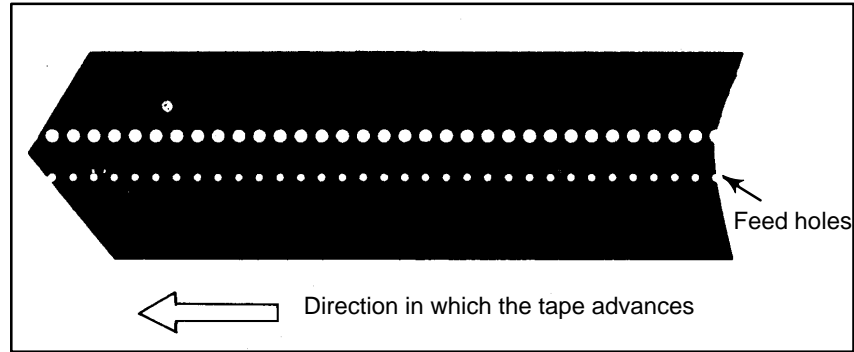
#### Preparations

- 1 Unlock the cover locks 9. Raise the tape reader with the handle 6 until it clicks, then lower the tape reader. The tape reader then appears and is secured. Check that the lowering lock levers 10 are horizontal.
- 2 Take out the signal and power cables from the cable storage 11 and connect the signal cable with the CNC reader/punch interface port and the power cable with the power supply.

#### Setting the tape

- 3 Turn the control switch to the RELEASE position.

- 4 Lift the Light Source Unit, and insert an NC tape between the gap. The tape must be positioned as shown in the figure, when viewed looking downward.



- 5 Pull the tape until the top of the tape goes past the Capstan roller.
- 6 Check that the NC tape is correctly positioned by the Tape Guide.
- 7 Lower the Light Source.
- 8 Turn the switch to the AUTO position.
- 9 Suspend the top and rear-end of the tape in the Tape Box.

**Removing the tape**

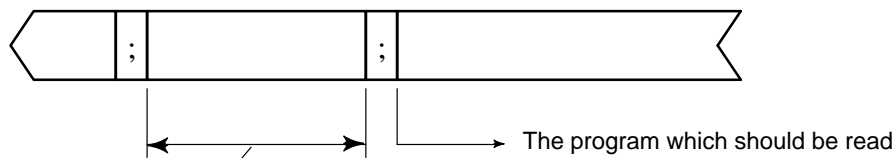
- 10 Turn the switch to the RELEASE position.
- 11 Lift the Light Source and remove the tape.
- 12 Lower the Light Source

**Storage**

- 13 Store the cables in the cable storage 11.
- 14 Push the lowering lock lever 10 at both sides down.
- 15 Raise the tape reader with the handle 6 to unlock the latch, then gently lower it.
- 16 Lock the cover lock 9 and carry the tape reader with the handle 6.

**CAUTION**  
**1 SETTING OF A TAPE**

When the NC tape is loaded, the Label Skip function activates to read but skip data until first End of Block code (CR in EIA code or LF in ISO code) is read. When loading an NC tape, the location within the tape, from which data reading should be started must properly be selected and the NC tape should be set as shown in the figure below.



Set the tape so that this section is under the glass window.

Actually, the end of block code (;) is CR in EIA code or is LF in ISO code.

**CAUTION****2 DISCONNECTION AND CONNECTION OF A PORTABLE TAPE READER CONNECTION CABLE**

Don't disconnect or connect CNC tape reader connection cable (signal cable) without turning off the CNC power supply, otherwise the PCB of the tape reader and master PCB of CNC controller may be broken. Turn off the CNC power supply before disconnecting or connecting the connection cable, accordingly.

**[Numbers]**

2nd, 3rd, and 4th reference position return (G30), 117  
 8-digit program number, 181

**[A]**

A block without tool movement, 316  
 A block without tool movement specified at start-up, 304  
 A block without tool movement specified in offset mode, 316  
 A block without tool movement specified together with offset cancel, 322  
 Abbreviations of arithmetic and logic operation commands, 398  
 Abbreviations of custom macro word, 779  
 About this manual, 3  
 Absolute and incremental programming (G90, G91), 136  
 Absolute and relative position display, 489  
 Absolute coordinates, 19  
 Absolute position display, 257  
 Acceleration/deceleration before interpolation, 107, 110  
 Acceleration/deceleration for rapid traverse, 579  
 Acceleration/deceleration type, 460  
 Actual feedrate display, 815  
 Actual feedrate display of rotary axis, 816  
 Actual feedrate display on the other screen, 816  
 Actual feedrate value, 815  
 Adding workpiece coordinate systems (G54.1 or G54), 130  
 Addition and change of tool life management data, 154, 155  
 Address for the canned cycle repetition count, 451  
 Address for the cutter compensation offset number, 451  
 Alarm, 631, 636, 833  
 Alarm and self-diagnosis functions, 682  
 Alarm detail screen, 934  
 Alarm display, 534, 683  
 Alarm during three-dimensional tool compensation, 357  
 Alarm history display, 685  
 Alarm issued at startup, 357  
 Alarm list, 972  
 Alarm screen, 683  
 Alarm status, 896  
 Alarms during background editing, 780  
 Altering a word, 761  
 An alarm while a program is output, 698  
 Angle, 913  
 Angle between two blocks, 107  
 Angle for which figure insertion is ignored, 375  
 Angle of the C axis, 373  
 Angle units, 396  
 Angular axis control/angular axis control B, 488  
 Angular displacement R, 256

ANIM.SPEED, 926  
 Another method for alarm displays, 683  
 Arc radius specification in the cylindrical interpolation mode, 61  
 ARCCOS #i = ACOS[#j];, 396  
 ARCSIN #i = ASIN[#j];, 396  
 Argument specification, 408, 414, 415, 416  
 Arithmetic and logic operation, 396  
 Automatic acceleration/deceleration, 92  
 Automatic corner deceleration, 106  
 Automatic Erase Screen Display, 900  
 Automatic grinding wheel diameter compensation after dressing, 240  
 Automatic insertion of sequence numbers, 790  
 Automatic operation, 525, 612  
 Automatic operation control, 390  
 Automatic operation status, 895  
 Automatic override for inner corners, 100  
 Automatic override for inner corners (G62), 102  
 Automatic reference position return, 481  
 Automatic reference position return check, 481  
 Automatic scaling, 908  
 Automatic tool length measurement (G37), 272  
 Auxiliary function, 161, 657  
 Auxiliary function (M function), 162  
 Auxiliary function lock, 528, 665  
 Available functions, 456  
 Axes, 912  
 Axes that are not considered part of a polar coordinate command in the polar coordinate mode, 139  
 Axis configuration, 590, 593  
 Axis control functions, 479  
 Axis moving status/dwell status, 895  
 Axis name, 29  
 Axis No. (P\_), 449  
 Axis selection, 649

**[B]**

Background drawing, 930  
 Background editing, 780  
 Base circle specification, 65  
 Battery for Separate Absolute Pulse Coders, 946  
 Biplane view, 913  
 Blank figure graphics, 917  
 Blank form, 922  
 Block, 24  
 Block configuration (word and address), 173  
 Block containing G40 and I\_J\_K\_, 323  
 Block end position, 247  
 Block that disables reverse movement, 654  
 Block to be repeated a specified number of times, 852  
 Boring cycle, 207

Boring cycle (G86), 209  
 Boring cycle (G88), 213  
 Boring cycle (G89), 215  
 Boring cycle back boring cycle (G87), 211  
 Bracket nesting, 398  
 Brackets, 399  
 Branch and repetition, 402  
 Buffering the next block in cutter compensation mode (G41, G42), 421  
 Buffering the next block in other than cutter compensation mode (G41, G42) (normally prereading one block), 420

## [C]

C axis feedrate, 375  
 Call, 408, 412, 417  
 Call nesting, 409, 412  
 Calling a subprogram stored in an external input/output device, 615  
 Calling of sub-program, 162  
 Cancel, 188  
 Cancel of the compensation function, 122  
 Canceling three-dimensional tool compensation, 355  
 Cancellation, 412, 658  
 Canned cycle, 185  
 Canned cycle cancel, 217  
 Canned cycle cancel (G80), 229  
 Canned grinding cycle (for grinding machine), 230  
 Center of rotation, 254  
 Center or max./min., 914  
 Chamfering, 242  
 Change from G23 to G22 in a forbidden area, 678  
 Change in the offset direction in the offset mode, 310  
 Change of modes, 579  
 Change of the cutter compensation value, 291, 296  
 Changing by G10, 125  
 Changing of drawing direction, 917  
 Changing parameter PASSWD, 781  
 Changing the coordinate system, 916  
 Changing the drilling conditions, 203  
 Changing the offset value, 273  
 Changing workpiece coordinate system, 125  
 Character-to-codes correspondence table, 971  
 Characters and codes to be used for the pattern data input function, 447  
 Check by running the machine, 527  
 Check byte, 460  
 Checking by self-diagnostic screen, 686  
 Checking contents of the memory, 794  
 Checking during search, 767  
 Checking the feedrate difference, 111  
 Checking the minimum grinding wheel diameter (for grinding machine), 240  
 Checkpoint for the forbidden area, 677  
 Choosing from two types of involute curves, 66  
 Chopping function (G80, G81.1), 490  
 Chopping function (G81.1), 656  
 Circular interpolation (G02, G03), 45, 60, 655  
 Circular interpolation and cutter compensation, 61  
 Clamp of maximum spindle speed, 144  
 Clamping maximum spindle speed (G92Sxxxx), 656  
 Clear, 635  
 Clearing the screen, 899  
 Close command PCLOS, 426  
 CNC Control Unit with 7.2"/8.4" LCD, 539  
 CNC Control Unit with 9.5"/10.4" LCD, 539  
 Code specifying tool compensation value, 153  
 Collation, 695, 715  
 Color, 908, 915  
 Color of graph, 820  
 Combination of rotational and linear copying, 247  
 Combination of rotational copying and linear copying (bolt hole circle), 252  
 Command, 157  
 Command for three-dimensional coordinate conversion (program coordinate system), 253  
 Commands that clear the vector, 358  
 Commands that generate the same vector as the vector in the previous block, 358  
 Comment section, 169  
 Comments in a program, 789  
 Common variable, 707  
 Common variables, 706  
 Compensation function, 263  
 Compensation functions, 257  
 Component operations of the cycle, 202  
 Concept of word and editing nit, 756  
 Conditional branch (IF statement), 403  
 Conditional expression, 403  
 Conditions for enabling and disabling the custom macro interrupt signal, 432  
 Constant surface speed control (G96, G97), 144  
 Constant surface speed control cancel command, 144  
 Constant surface speed control command, 144  
 Constant surface speed control command (G96), 145  
 Constant surface speed control on/off (G96, G97), 656  
 Constant surface speed controlled axis command, 144  
 Continuous high-speed skip function (G31), 90  
 Continuous-feed surface grinding cycle (G78), 235  
 Controlled axes, 28, 29  
 Conversational programming with graphic function, 795  
 Coordinate system, 121, 244  
 Coordinate system for the polar coordinate, 57  
 Coordinate system on part drawing and coordinate system specified by CNC - Coordinate system, 16



- 
- Coordinate system rotation (G68, G69), 366
  - Coordinate system setting, 61
  - Coordinate value and dimension, 135
  - Copying a Program Between Two Paths, 518, 783
  - Copying an entire program, 771
  - Copying part of a program, 772
  - Corner Circular Interpolation (G39), 353
  - Corner deceleration according to the corner angle, 106
  - Corner deceleration according to the feedrate difference between blocks along each axis, 109
  - Corner movement, 317
  - Corner offset circular interpolation, 282
  - Corner offset circular interpolation (G39), 288
  - Corner R, 242
  - Corner roundness, 108
  - Correction of interference in advance, 327
  - Correspondence between parameter numbers and program numbers, 414, 415, 416
  - Creating a program, 795
  - Creating programs, 788
  - CREATING PROGRAMS IN TEACH IN MODE (Playback), 792
  - Creating programs using the MDI panel, 789
  - Criteria for detecting interference, 325
  - Cross section position change, 927
  - Cross section position selection in triplane drawing, 929
  - Current block display screen, 823
  - Current mode, 895
  - Current position, 393
  - Current position display, 534, 826
  - Current position display in the polar coordinate interpolation mode, 57
  - Current time, 896
  - Custom macro, 383
  - Custom macro interface, 204
  - Custom macro interrupt and custom macro modal call, 437
  - Custom macro interrupt and modal information, 435
  - Custom macro interrupt and program restart, 437
  - Custom macro interrupt during execution of a block that involves cycle operation, 432
  - Custom macro interrupt signal (UINT), 433
  - Custom macro interrupts and NC statements, 430
  - Custom macro operation, 657
  - Custom macro system variables, 257
  - Cutter compensation, 460
  - Cutter compensation B (G39 – G42), 281
  - Cutter compensation C, 66, 300
  - Cutter compensation cancel, 282
  - Cutter compensation cancel (G40), 289
  - Cutter compensation cancel (offset mode cancel), 295
  - Cutter compensation G code in the offset mode, 315
  - Cutter compensation left (G41), 284
  - Cutter compensation right (G42), 286
  - Cutter compensation value setting, 297
  - Cutting accuracy, 68
  - Cutting feed, 95
  - Cutting feedrate clamp, 99
  - Cutting feedrate control, 100
  - Cutting feedrate for the rotation axis, 58
  - Cutting mode, 100
  - Cutting mode (G64), 101
  - Cutting time, 854
  - Cycle start for the 16-TTA and 18-TTA, 615
  - Cycle time, 817, 854
  - Cylindrical interpolation (G07.1), 60
  - Cylindrical interpolation accuracy, 61
  - Cylindrical interpolation mode setting, 61
- 
- [D]**
- Data and time, 854
  - Data input/output, 536, 689
  - Data Input/Output On the All IO Screen, 717
  - Data Input/Output Using a Memory Card, 743
  - Data output command BPRNT, 424
  - Data output command DPRNT, 425
  - Data protection key, 532, 799
  - Data that can be specified, 462
  - Decimal point input, 845
  - Decimal point programming, 141
  - Default axis name, 30
  - Deleting a block, 763, 798
  - Deleting a word, 762
  - Deleting all programs, 768
  - Deleting blocks, 763
  - Deleting files, 714
  - Deleting multiple blocks, 764
  - Deleting one program, 768
  - Deleting programs, 768
  - Deleting the previous drawing, 907
  - Deletion of tool life management data, 154, 155
  - Description of each display, 895
  - Detailed information of alarm, 933
  - Details of memory used, 838
  - Differences between macro calls and subprogram calls, 407
  - Differences from NC statements, 401
  - Direct constant-dimension plunge grinding cycle (G77), 233
  - Direct Input of Measured Workpiece Origin Offsets, 856
  - Direction and value of rotation, 260
  - Direction of the offset, 265
  - Disabling entry of compensation values, 845
  - Disagreement between end point and start point, 247

Display, 533  
 Display including compensation values, 811  
 Display mode, 927  
 Display of run time and parts count, 817  
 Display of software configuration, 574  
 Display of the coordinate, 927  
 Display of the coordinate value, 916  
 Display of the servo axes, 819  
 Display of the spindle axes, 819  
 Display on the other screen, 817  
 Display procedure for the actual feedrate on the current position display screen, 815  
 Display procedure for the current position screen in the workpiece coordinate system, 807  
 Display procedure for the current position screen with the relative coordinate system, 809  
 Displaying a program list for a specified group, 840  
 Displaying actual speed for master axis only, 481  
 Displaying and entering setting data, 849  
 Displaying and setting chopping data, 871  
 Displaying and setting custom macro common variables, 858  
 Displaying and setting data, 530  
 Displaying and setting extended tool life management, 866  
 Displaying and setting operator's setting data, 531  
 Displaying and setting parameters, 532, 890  
 Displaying and setting pitch error compensation data, 892  
 Displaying and setting run time, parts count, and time, 853  
 Displaying and setting the software operator's panel, 861  
 Displaying and setting the workpiece origin offset value, 855  
 Displaying and setting tool life management data, 863  
 Displaying coordinate axes and actual size dimensions lines, 909  
 Displaying directory of floppy cassette, 708  
 Displaying memory used and a list of programs, 837  
 Displaying pattern data and pattern menu, 859  
 Displaying the directory, 709  
 Displaying the directory of floppy cassette files, 709  
 Displaying the floppy disk directory during file execution, 636  
 Displaying the pattern menu, 439  
 Displaying the program number and sequence number, 894  
 Displaying the program number, sequence number, and status, and warning messages for data setting or input/output operation, 894  
 Displaying the status and warning for data setting or input/output operation, 895  
 Distance moved and feedrate for polar coordinate interpolation, 57  
 Divisor, 400  
 DNC operation, 620  
 Drawing a part of a program, 907  
 Drawing enlargement and reduction, 908  
 Drawing of final machined figure, 917  
 Drawing of machining progress, 917  
 Drawing plane, 908  
 Drawing rotation, 908

Drawing using dashed lines and solid lines, 907  
 Drilling axis, 186  
 Drilling cycle counter boring cycle, 197  
 Drilling cycle, spot drilling (G81), 195  
 Drilling mode, 187  
 Dry run, 527, 669  
 Dry run feedrate, 669  
 Duplicate axis names, 30  
 Dwell (G04), 113, 655  
 Dynamic graphic display, 908

---

## [E]

Editing a part program, 529  
 Editing of custom macros, 779  
 Editing programs, 755  
 Editing unit, 779  
 Editing when the system waiting for a program number to be entered, 775  
 Effective time for a forbidden area, 677  
 Efficient use of memory, 698  
 Emergency stop, 673  
 Emergency stop or reset status, 896  
 Enabling and disabling manual intervention and return, 658  
 End of program, 162  
 End of subprogram, 162  
 End point error, 67  
 End position for the arc is not on the arc, 309  
 Endless repetition, 635  
 Equation for three-dimensional coordinate conversion, 255  
 Erase Screen Display, 899  
 Erasing the program, 618  
 Error codes, 684  
 Exact stop, 100, 108, 111  
 Exact stop (G09, G61), 101  
 Example of a cylindrical interpolation program, 62  
 Example of changing T15 to M15, 761  
 Example of deleting a block of N01234, 763  
 Example of deleting block containing N01234 to a block containing N56789, 764  
 Example of deleting X100.0, 762  
 Example of inserting T15, 760  
 Exceeding the move range, 244  
 Exceptional blocks, 852  
 Executing drawing only, 907  
 Explanation of the pattern data screen, 860  
 Explanation of the pattern menu screen, 860  
 Exponential interpolation (G02.3, G03.3), 69  
 Exponential relational expressions, 70  
 Extended part program editing function, 770  
 External I/O devices, 567

External motion function (G81), 245  
 External operator message history display, 897  
 External output commands, 424

---

## [F]

FANUC FA card, 570  
 FANUC floppy cassette, 569  
 FANUC handy file, 569  
 FANUC PPR, 570  
 Feed functions, 91, 92  
 Feed hold, 649  
 Feed hold and interlock, 460  
 Feed per minute (G94), 96  
 Feed per revolution (G95), 96  
 Feedfold, 614  
 Feedrate, 60, 66, 261, 654, 907  
 Feedrate and time, 107, 109  
 Feedrate clamping by arc radius, 455  
 Feedrate override, 204, 527, 667  
 Figure copy (G72.1, G72.2), 246  
 File deletion, 694  
 File heading, 692  
 File number after the file is deleted, 694  
 File output location, 698  
 File search, 692  
 File search by N-9999, 692  
 Files, 690  
 Fine boring cycle (G76), 193  
 First block of the subprogram, 246  
 Floating Reference Position Return (G30.1), 120  
 Flowchart for feedrate control, 106, 109  
 Forbidden area over lapping, 677  
 Format, 699  
 Format error, 254  
 Forward movement and reverse movement, 653  
 Forward return movement, 653  
 Free purpose, 854  
 Function keys, 547  
 Function keys and soft keys, 546  
 Functions that can be specified, 204  
 Functions to simplify programming, 184

---

## [G]

G code for selecting a plane: G17,G18 or G19, 367  
 G codes that can be specified, 256  
 G codes which can be specified in the polar coordinate interpolation mode, 57  
 G00 (positioning) or G01 (linear interpolation), 284, 286

G02 or G03 (circular interpolation), 287  
 G02, G03 (circular interpolation), 285  
 G53 specification immediately after power-on, 122  
 General purpose switches, 862  
 General screen operations, 546  
 Graphic condition, 916, 929  
 Graphic display, 535  
 Graphic method, 927  
 Graphic program, 916, 926  
 Graphic screen, 563  
 Graphics display, 902  
 Graphics display procedure, 902  
 Graphics function, 901  
 Graphics method and direction (P), 923  
 Graphics parameter, 906, 922  
 Grinding wheel wear compensation, 379  
 Grinding-wheel wear compensation by continuous dressing (for grinding machine), 239  
 Group numbers, 164

---

## [H]

H code, 282  
 Handle interruption, 526  
 Heading a program, 759  
 Helical interpolation, 929  
 Helical interpolation (G02, G03), 49  
 Helical Interpolation B (G02, G03), 50  
 Help function, 933  
 Help function procedure, 933  
 Help screen, 562  
 High speed cutting functions, 452  
 High speed skip signal (G31), 89  
 High-precision contour control, 462  
 High-Speed Linear Interpolation (G05), 476  
 High-speed peck drilling cycle (G73), 189  
 High-speed peck tapping cycle, 228  
 High-speed remote buffer, 458  
 High-speed remote buffer A (G05), 458  
 High-speed remote buffer B (G05), 461  
 HNGx, 582  
 Hobbing Machine Function (G80, G81), 496  
 Horizontal hole machining, 917  
 How to indicate command dimensions for moving the tool – absolute, incremental commands, 19  
 How to use nomograph, 962  
 How to view the position display change without running the machine, 528  
 HPCC mode, 462  
 HPF, 582  
 Hypothetical axis interpolation (G07), 82

---

**[I]**

I/O channel, 850  
 I/O devices, 715  
 In-feed grinding along the Y and Z axes at the end of table swing (for grinding machine), 241  
 Inch/metric conversion (G20,G21), 140  
 Incorrect threaded length, 961  
 Increase and decrease, 277  
 Increment in angular displacement or shift, 247  
 Increment system, 31  
 Incremental command, 19  
 Incremental feed, 580  
 Incrementing the number of machined parts, 817  
 Index table indexing function, 61, 260  
 Indexing function and other functions, 262  
 Indexing position, 260  
 Indicating the coordinates of the current position, 908  
 Indicating the current tool position with a mark, 908  
 Inner side and outer side, 300  
 Input command from MDI, 333  
 Input unit, 850  
 Inputting a program, 695  
 Inputting and Outputting Floppy Files, 729  
 Inputting and Outputting Offset Data, 726  
 Inputting and Outputting Parameters, 724  
 Inputting and outputting parameters and pitch error compensation data, 702  
 Inputting and Outputting Programs, 719  
 Inputting custom macro common variables, 706  
 Inputting file numbers and program numbers with keys, 715  
 Inputting multiple programs from an NC tape, 695  
 Inputting offset data, 700  
 Inputting parameters, 702  
 Inputting pitch error compensation data, 704  
 Inputting/outputting custom macro common variables, 706  
 Inserting a block, 798  
 Inserting a word, 760  
 Inserting, altering and deleting a word, 756  
 Intensity, 925  
 Interface signals, 388  
 Interference check, 325  
 Intermittent-feed surface grinding cycle (G79), 237  
 Internal circular cutting feedrate change, 100, 105  
 Interpolation functions, 38  
 Interrupt conditions, 429  
 Interrupt-type custom macro, 655  
 Interruption of manual operation, 318  
 Interruption of return operation, 649  
 Interruption type custom macro, 428  
 Invalid scaling, 364

Inverse time feed (G93), 97, 656  
 Involute curve, 65  
 Involute interpolation (G02.2, G03.2), 63  
 ISO code, 699  
 Isometric projection (XYZ,ZXY), 913

**[J]**

JHD, 582  
 Jog feed, 578  
 Jog feed and arrow keys, 862

**[K]**

Key input a input buffer, 564

**[L]**

Leader section, 168  
 Left-handed rigid tapping cycle (G74), 224  
 Left-handed tapping cycle (G74), 191  
 Life count override, 870  
 Life value, 154  
 Linear copy, 246, 251  
 Linear interpolation, 43  
 List of function and tape format, 952  
 Load meter, 819  
 Local coordinate system, 132  
 Local variable levels, 409  
 Look-ahead control, 108, 112  
 Look-ahead control (G08), 456

**[M]**

M code, 416, 635  
 M code group check function, 164  
 M code setting, 164  
 M codes for custom macro interrupt control, 430  
 M codes not locked by auxiliary function lock, 666  
 M, S, T command by only machine lock, 666  
 M02, 833  
 Machine coordinate system, 122  
 Machine lock, 528, 665  
 Machine lock and auxiliary function lock, 665  
 Machine lock, mirror image, and scaling, 658  
 Machine position display, 489  
 Machining a groove smaller than the tool radius, 330  
 Machining a step smaller than the tool radius, 331  
 Machining an inside corner at a radius smaller than the cutter radius, 330

Machining time, 833  
 Machining using the end of cutter – Tool length compensation function, 26  
 Machining using the side of cutter – Cutter compensation function, 26  
 Macro alarms, 389  
 Macro call, 407, 619  
 Macro call using an M code, 415  
 Macro call using G code, 414  
 Macro commands specifying the menu title, 440  
 Macro instruction describing the pattern name, 441  
 Macro instruction specifying the pattern data title (the menu title), 444  
 Macro instruction specifying the variable name, 444  
 Macro instruction to describe a comment, 445  
 Macro statements, 401  
 Main program and subprogram, 25, 166  
 Major addresses and ranges of command values, 174  
 Manual absolute, 631  
 Manual absolute on and off, 584  
 Manual absolute on/off, 658  
 Manual handle feed, 581  
 Manual handle interruption, 639  
 Manual intervention, 631, 657  
 Manual intervention and return, 658  
 Manual linear/circular interpolation, 597  
 Manual Numeric Command, 604  
 Manual operation, 522, 575  
 Manual operation after a feed hold, 585  
 Manual operation after single block stop, 588  
 Manual operation after the end of block, 585  
 Manual operation during cornering, 588  
 Manual operation during cutter compensation, 586  
 Manual operation performed in other than cornering, 587  
 Manual pulse generator, 581  
 Manual reference position return, 119, 522, 576  
 Mark display, 912  
 Mark for the tool current position, 916  
 Master axis and slave axis, 481  
 Material dimensions (I, J, K), 922  
 Material positions (X, Y, Z), 922  
 Maximum stroke, 32  
 MDI mode, 658  
 MDI operation, 616, 828  
 Meaning of symbols, 300  
 Memory area, 619  
 Memory Card Input/Output, 734  
 Memory common to path, 517  
 Memory operation, 524, 613, 614  
 Memory operation using FS15 tape format, 451  
 Merging a program, 774

Message screen, 562  
 Method of replacing battery, 941  
 Mirror image, 391, 460, 642, 657, 850  
 Modal call (G66), 412  
 Modal call nesting, 412  
 Modal information, 392, 828  
 Modifying a block, 797  
 Movement along axes not in the polar coordinate interpolation plane in the polar coordinate interpolation mode, 57  
 Movement for which arc insertion is ignored, 376  
 Moving part of a program, 773  
 Moving the tool again, 577  
 Multiple M commands in a single block, 163  
 Multistage skip (G31), 88

---

## [N]

NC statements, 401  
 NC statements that have the same property as macro statement, 401  
 Nesting, 405  
 Nesting of calls using G codes, 414  
 Next block, 244  
 Next block display screen, 824  
 Nomographs, 960  
 Normal direction control (G40.1, G41.1, G42.1 or G150, G151, G152), 372  
 Normal direction control axis, 375  
 Normal direction control of the C axis, 373  
 Normal operation, 481  
 Number of digits for program number, 775  
 Number of files registered, 635  
 Number of involute curve turns, 68  
 Number of lines in a program, 618  
 Number of machined parts, 392  
 Number of repetitions, 635  
 Number of tool compensation values and the addresses to be specified, 359  
 Nurbs Interpolation (G06.2), 77

---

## [O]

Offset, 658  
 Offset cancel mode, 295  
 Offset data input and output, 700  
 Offset mode, 295  
 Offset mode cancel, 296  
 Offset plane selection and offset vector, 283  
 Offset value, 530  
 Offset vector in interpolation, 357  
 Offset/setting screen, 558, 803  
 Omission of the decimal point, 385

- 
- On the memo record, 699
  - One-digit F code feed, 99
  - Open command POPEN, 424
  - Operating motor display, 819
  - Operating time, 854
  - Operation after completion of repositioning, 649
  - Operation during search, 767
  - Operation error, 399
  - Operation method, 933
  - Operation method screen, 935
  - Operation mode, 814
  - Operation of portable tape reader, 994
  - Operation performed when the total depth of cut is reached, 236
  - Operational devices, 537
  - Operators, 403
  - Optional angle chamfering and corner rounding, 242
  - Optional block skip, 175, 615
  - Optional stop, 162
  - Optional stop (M01), 614
  - Order in which programs are registered, 839
  - Other setting method, 845
  - Output file name, 701, 704, 705, 707
  - Output format, 701, 703, 705, 707
  - Outputting a program, 698
  - Outputting a program after file heading, 698
  - Outputting a program list for a specified group, 716
  - Outputting custom macro common variable, 707
  - Outputting Custom Macro Common Variables, 728
  - Outputting offset data, 701
  - Outputting parameters, 703
  - Outputting pitch error compensation data, 705
  - Outputting programs, 713
  - Overall position display, 812
  - Overcutting by cutter compensation, 330
  - Overload torque detection signal, 202
  - Override, 92, 111, 658
  - Override condition, 102
  - Override during thread, 667
  - Override range, 103, 667
  - Override value, 104
  - Overtravel, 674
  - Overtravel during automatic operation, 674
  - Overtravel during manual operation, 674
  - Overview of cutter compensation C (G40 – G42), 294
- 
- [P]**
- P-type restart, 630
  - Parameter list, 891
  - Parameter setting, 817
  - Parameter setting value (R\_), 449
  - Parameter table, 933, 936
  - Parameter write, 850
  - Parameters that require turning off the power, 891
  - Part count, 817
  - Partial drawing, 908
  - Partial enlargement, 911, 916
  - Partial enlargement drawing, 908
  - Parts count, 854
  - Parts count display, run time display, 535
  - Parts required, 853
  - Parts total, 853
  - Password function, 781
  - Path drawing, 908
  - Path drawing procedure, 909
  - Path memorization, 649
  - Pattern data display, 443
  - Pattern data input function, 438
  - Pattern No. selection, 441
  - Peck drilling cycle (G83), 199
  - Peck tapping cycle, 228
  - Peek rigid tapping cycle (G84 or G74), 227
  - Performing tool length offset along two or more axes, 267
  - Pitch error compensation, 705
  - Pitch error compensation data, 704
  - Plane selection, 134, 244
  - Plane selection (G17, G18, G19), 60
  - Plane selection and vector, 298
  - Plane switching, 244
  - Plane view (XY,YZ,ZY,XZ), 912
  - Plane view graphics, 917
  - Plunge grinding cycle (G75), 231
  - Polar coordinate command (G15, G16), 137
  - Polar coordinate interpolation (G12.1, G13.1), 56
  - Portable tape reader, 571
  - Position display, 640
  - Position display in the relative coordinate system, 809
  - Position display in the work coordinate system, 807
  - Position display screen, 800
  - Position mark, 916
  - Position screen, 549
  - Positioning, 61
  - Positioning (G00), 39, 655
  - Positioning and auxiliary functions, 467
  - Positioning plane, 186
  - Positive/negative cutter compensation value and tool center path, 292, 297
  - Power disconnection, 574
  - Power on, 854
  - Power on/off, 572

- Preparatory function (G function), 33
- Presetting by setting a coordinate system, 811
- Presetting relative coordinates, 814
- Presetting the relative coordinate system, 818
- Presetting the workpiece coordinate system, 814
- Priority of operations, 398
- Procedure for alarm history display, 685
- Procedure for altering a word, 761
- Procedure for automatic insertion of sequence numbers, 790
- Procedure for background editing, 780
- Procedure for conversational programming with graphic function, 795
- Procedure for copying part of a program, 772
- Procedure for creating programs in TEACH IN mode, 792
- Procedure for creating programs using the MDI panel, 789
- Procedure for deleting a block, 763
- Procedure for deleting a word, 762
- Procedure for deleting all programs, 768
- Procedure for deleting more than one program by specifying a range, 769
- Procedure for deleting multiple blocks, 764
- Procedure for deleting one program, 768
- Procedure for diagnosis, 686
- Procedure for Direct Inputting of Measured Workpiece Origin Offsets, 856
- Procedure for display and setting the tool life management data, 863
- Procedure for displaying and setting custom macro common variables, 858
- Procedure for displaying and setting extended tool life management, 866
- Procedure for displaying and setting parameters, 890
- Procedure for displaying and setting run time, parts count and time, 853
- Procedure for displaying and setting the pitch error compensation data, 893
- Procedure for displaying and setting the software operator's panel, 861
- Procedure for Displaying and Setting the Workpiece Origin Offset Value, 855
- Procedure for displaying memory used and a list of programs, 837
- Procedure for displaying overall position display screen, 812
- Procedure for displaying run time and parts count on the current position display screen, 817
- Procedure for displaying the current block display screen, 823
- Procedure for displaying the next block display screen, 824
- Procedure for displaying the operating monitor, 819
- Procedure for displaying the pattern data and the pattern menu, 859
- Procedure for displaying the program check screen, 825
- Procedure for displaying the program contents, 822
- Procedure for displaying the program screen for MDI operation, 828
- Procedure for dry run, 669
- Procedure for enabling/displaying parameter writing, 891
- Procedure for executing one file, 633
- Procedure for executing the scheduling function, 634
- Procedure for feedrate override, 667
- Procedure for hange of words or addresses, 777
- Procedure for heading a program, 759
- Procedure for incremental feed, 580
- Procedure for inserting a word, 760
- Procedure for inserting, altering and deleting a word, 756
- Procedure for locking and unlocking, 781
- Procedure for machine lock and auxiliary function lock, 665
- Procedure for manual handle feed, 581
- Procedure for manual linear/circular interpolation, 597
- Procedure for manual reference position return, 576
- Procedure for manual rigid tapping, 602
- Procedure for MDI operation, 616
- Procedure for measuring the tool length offset value, 872
- Procedure for merging a program, 774
- Procedure for moving part of a program, 773
- Procedure for outputting a program list for a specified group, 716
- Procedure for presetting the workpiece coordinate system, 814
- Procedure for program number search, 765
- Procedure for retrace operation, 650
- Procedure for scanning a program, 757
- Procedure for searching a word, 758
- Procedure for searching an address, 758
- Procedure for sequence number comparison and stop, 851
- Procedure for sequence number search, 766
- Procedure for setting and displaying the cutter compensation value, 844
- Procedure for setting the floating reference position, 818
- Procedure for setting the setting data, 849
- Procedure for single block, 670
- Procedure for tool length measurement, 847
- Procedure for tool withdrawal and return, 644
- Procedure of copying an entire program, 771
- Procedure to reset all axes, 810
- Procedure to set the axis coordinate to a specified value, 810
- Processing macro statements, 420
- Profile program, 241
- Program, 24
- Program check screen, 825
- Program components, 167
- Program components other than program sections, 168
- Program configuration, 166
- Program contents display, 822
- Program directory, 833, 834
- Program display, 533, 826
- Program editing status, 896
- Program end, 176
- Program end (M02, M03), 614
- Program input/output, 695
- Program library list, 838
- Program name, 838

- Program number, 171
- Program number search, 765
- Program numbers on a NC tape, 696
- Program registration, 618
- Program registration in the background, 696
- Program restart, 58, 625
- Program screen, 550, 552, 554, 555, 556, 801, 802
- Program screen for MDI operation, 828
- Program section configuration, 167, 171
- Program selection, 525
- Program start, 168
- Program stop, 162
- Program stop (M00), 614
- Programmable data setting (G10), 655
- Programmable mirror image (G50.1, G51.1), 377
- Programmable parameter entry (G10), 449
- Programmed path and tool path drawing, 908
- Projection, 923
- Protect switch, 691, 694
- Pulse distribution to basic axes, 590, 594
- Punch code, 850
- Punching all programs, 699
- Punching programs in the background, 699
- Register with deleting all groups, 154, 155
- Register, change and delete of tool life management data, 154
- Registering a position with compensation, 794
- Registering commands other than position commands, 794
- Registering custom macro programs, 422
- Related manuals, 4
- Relation with other functions, 640
- Relationship between three-dimensional and two-dimensional coordinate conversion (G68, G69), 257
- Relationship between three-dimensional tool compensation and other compensation functions, 356
- Releasing overtravel, 674
- Releasing the alarms, 678
- Removing the tape, 996
- Repeat, 188
- Repetition, 414, 415, 416
- Repetition (while statement), 404
- Repetitive commands for coordinate system rotation, 371
- Replacement of words and addresses, 777
- Replacing custom macros, 778
- Replacing the Alkaline Dry Cells (Size D), 944
- Repositioning, 485
- Repositioning immediately after retraction, 648
- Request for floppy replacement, 690
- Reset, 257, 614, 631, 649, 654
- Reset of the alarm, 684
- Restart, 618
- Restart block, 630
- Restarting automatic operation, 636
- Retrace function, 650
- Retraction, 485
- Retraction from the automatic operation hold or stop state, 648
- Retreat and retry function, 660
- Retreat and retry functions, 507
- Return, 485
- Return from a custom macro interrupt, 434
- Return from reference position, 116
- Return from the reference position (G29), 117
- Return operation, 658
- Return path, 649
- Return point level G98/G99, 188
- Return to a reference position (G28, G30, G30.1), 357
- Return to the program screen, 635
- Reverse movement completion, 653
- Review, 920
- Ridge drawing, 927
- Rigid tapping, 220
- Rigid tapping (G84), 221
- Rotary axis roll-over, 483
- Rotation, 913
- Rotational copy, 246, 249

---










## [R]













- Radius direction error at circle cutting, 968
- Range (actual graphic range), 903
- Range of command value, 957
- Range of variable values, 385
- Rapid traverse, 94
- Rapid traverse override, 668
- Rapid traverse prior to reference position return, 579
- Rapid traverse rate in drilling of a canned cycle, 257
- Re-locking, 782
- Reading files, 712
- Reference position, 114
- Reference position (machine-specific position), 15
- Reference Position Return, 115
- Reference position return, 116, 631
- Reference position return (G28), 117
- Reference position return and movement from the reference position, 116
- Reference position return and single block, 671
- Reference position return check, 116
- Reference position return check (G27), 117, 357
- Reference position return completion LED, 577
- Reference position return under machine lock, 666
- Referencing variables, 385
- Register of tool life count type, 154



Rotational copy (spot boring), 250  
 ROUND function, 397  
 Rounding up and down to an integer, 398  
 Run time, 817  
 Run time and part count settings, 854

## [S]

S5-Digit command, 143  
 Safety functions, 672  
 Scale, 914  
 Scaling (G50, G51), 361  
 Scaling and coordinate system rotation, 369  
 Scaling of circular interpolation, 363  
 Scaling of each axis, programmable mirror image (negative magnification), 362  
 Scaling up or down along all axes at the same rate of magnification, 362  
 Scheduling function, 632  
 Scheduling function for the 16-TTA and 18-TTA, 636  
 Screen displayed at power-on, 573  
 Screen fields and their meanings, 711  
 Screen indicating module setting status, 574  
 Screen transition chart, 799  
 Screen transition triggered by the function key  , 803  
 Screen transition triggered by the function key  , 800  
 Screen transition triggered by the function key  in the EDIT mode, 802  
 Screen transition triggered by the function key  in the MEMORY or MDI mode, 801  
 Screen transition triggered by the function key  , 804  
 Screens displayed by function key (In memory mode or MDI mode), 821  
 Screens displayed by function key  , 806  
 Screens displayed by function key  , 843  
 Screens displayed by function key  (in the edit mode), 837  
 Screens displayed by function key  , 889, 897  
 Screens on which jog feed is valid, 862  
 Searching in sub-program, 767  
 Selected plane, 108  
 Selecting a machine coordinate system (G35), 122  
 Selecting a workpiece coordinate system, 124  
 Selecting offset space, 355  
 Selecting the additional workpiece coordinate systems, 130  
 Selection of the offset plane, 282, 295  
 Separate-Type Small MDI Unit, 540  
 Separate-Type Standard MDI Unit (Horizontal Type), 541  
 Separate-Type Standard MDI Unit (Vertical Type), 542  
 Separate-Type Standard MDI Unit (Vertical Type) (for 160i/180i), 543  
 Sequence number after the program is executed, 852  
 Sequence number and block, 172  
 Sequence number comparison and stop, 851  
 Sequence number search, 766  
 Sequence stop, 850  
 Setting 0 in parameter PASSWD, 782  
 Setting a forbidden area for two-path control, 678  
 Setting a tool life count type for groups, 156  
 Setting a workpiece, 123  
 Setting an editing range, 775  
 Setting and Display Units, 538  
 Setting and displaying data, 799  
 Setting and displaying the tool offset value, 844  
 Setting basic axes and rotary axes, 592, 596  
 Setting data, 891  
 Setting Input/Output-Related Parameters, 718  
 Setting of the reference position return feedrate, 117  
 Setting parameter PASSWD, 781  
 Setting parameters with external input/output devices, 891  
 Setting screens, 805  
 Setting the allowable feedrate difference along each axis, 111  
 Setting the center coordinate of the graphics range and graphics magnification, 904  
 Setting the current position as the origin of the polar coordinate system, 138  
 Setting the floating reference position, 818  
 Setting the graphics range, 903  
 Setting the maximum and minimum coordinates for the drawing range in the program, 905  
 Setting the relative coordinates, 810  
 Setting the tape, 995  
 Setting the workpiece coordinate system, 272  
 Setting the workpiece coordinate system for constant surface speed control, 145  
 Setting the workpiece zero point offset value in the additional workpiece coordinate systems, 130  
 Setting the zero point of the workpiece coordinate system as the origin of the polar coordinate system, 137  
 Side view selection in triplane drawing, 928  
 Signal indicating that the cycle is in progress, 202  
 Significant digits, 715  
 Simple calculation of incorrect thread length, 963  
 Simple call (G65), 408  
 Simple electric gear box (G80, G81), 502

- Simple High-Precision Contour Control (G05.1), 470
- Simple synchronous control, 480
- Simultaneous input/output, 623
- Single block, 204, 528, 631, 649, 658, 670
- Single block during a canned cycle, 671
- Single direction positioning (G60), 41
- Skip function (G31), 86
- Skip function (G31), automatic tool length measurement (G37), 656
- Smooth interpolation (G05.1), 73
- Soft Key Configuration, 566
- Soft key functions on the "PATH GRAPHIC [EXECUTION]" screen, 915
- Soft key functions on the "solid graphic (Execution)" screen, 926
- Soft key transition triggered by the function key  , 563
- Soft key transition triggered by the function key  , 562
- Soft key transition triggered by the function key  , 562
- Soft key transition triggered by the function key  , 558
- Soft key transition triggered by the function key  , 549
- Soft key transition triggered by the function key  (when the soft key [BG-EDT] is pressed in all modes), 556
- Soft key transition triggered by the function key  in the EDIT mode, 552
- Soft key transition triggered by the function key  in the HNDL, JOG, or REF mode, 555
- Soft key transition triggered by the function key  in the MDI mode, 554
- Soft key transition triggered by the function key  in the MEM mode, 550
- Soft key transition triggered by the function key  in the TJOG or THDL mode, 555
- Soft key transition triggered by the function key  , 560
- Soft keys, 548
- Soft status display, 573
- Solid graphic (BLANK), 918
- Solid graphics, 917
- Solid graphics (EXECUTION), 919
- Solid model graphic, 917
- Specifiable G codes, 67
- Specification of the tool length offset value, 265
- Specifying a radius in the polar coordinate mode, 139
- Specifying address, 247
- Specifying address I, 204
- Specifying angles and a radius with absolute commands, 138
- Specifying angles with incremental commands and a radius with absolute commands, 138
- Specifying G28 (automatic return to the reference position) in the offset mode, 314
- Specifying G29 (automatic return from the reference position) in the offset mode, 314
- Specifying G37, 272
- Specifying I, J, and K, 357
- Specifying no file number, 635
- Specifying P codes, 131
- Specifying the blank form and tool form in the part program, 927
- Specifying the center of rotation, 247
- Specifying the second conversion, 256
- Specifying the sequence number for the return destination in the main program, 179
- Specifying the slave axis, 481
- Specifying the spindle speed value directly, 143
- Specifying the spindle speed with a code, 143
- Speedometer, 820
- Spindle speed function, 142
- Spiral Interpolation, Conical Interpolation (G02, G03), 51
- Stamping the machining time, 829, 833
- Start and stop, 525
- Start point and end point, 65
- Start seq. No. and end seq. No., 914, 926
- Start up, 295
- Start up (cutter compensation start), 282
- Start up (starting three-dimensional tool compensation), 355
- Start up (tool compensation start), 295
- Starting compensation and cutting along the Z-axis, 331
- State in which an auxiliary function is being executed, 895
- Status when turning power on, when clear and when reset, 969
- Stop in the canned cycle, 852
- Stopping and terminating memory operation, 614
- Stopping MDI operation, 617
- Stopping memory operation, 613
- Stopping retraction, 648
- Stopping the punch, 699
- Stored stroke check function on/off (G22,G23), 655
- Stroke check, 675
- Stroke limit check prior to performing movement, 679
- Style Fun, Style Name, Page# Sep, S function, 142
- SUBPROGRAM (M98, M99), 177
- Subprogram call, 177, 451
- Subprogram call and single block, 671
- SUBPROGRAM CALL FUNCTION (M198), 637
- Subprogram call using an M code, 416

Subprogram calling, 247  
 Subprogram calls using a T code, 417  
 Subprogram configuration, 177  
 Subprogram nesting, 618  
 Subprogram-type interrupt and macro-type interrupt, 430  
 Supplementary explanation for copying, moving and merging, 775  
 Surface speed specified in the G96 mode, 146  
 Switch between cutter compensation left and cutter compensation right, 290  
 Switching automatic operation mode, 655  
 Switching between synchronous operation and normal operation, 481  
 Symbols in figures, 188  
 Synchronous operation, 480  
 System screen, 560, 804  
 System variables, 388  
 System variables (position information values) for the interrupt program, 436

## [T]

Tandem control, 487  
 Tangential speed constant control, 95  
 Tape code list, 949  
 Tape end, 170  
 Tape format, 850  
 Tape start, 168  
 Tapping cycle, 205  
 Tapping mode, 100  
 Tapping mode (G63), 101  
 Temporary cutter compensation cancel, 314  
 Terminating MDI operation, 617  
 Terminating memory operation, 614  
 Test operation, 664  
 Testing a program, 527  
 THD, 582  
 The center of the arc is identical with the start position or the end position, 310  
 The characters for replacement, 778  
 The distance to return to reference position, 577  
 The length of the tool center path larger than the circumference of a circle, 324  
 The length of tool center path larger than the circumference of a circle, 313  
 The next block to G31 is an absolute command for 1 axis, 87  
 The next block to G31 is an incremental command, 87  
 The number of characters for replacement, 778  
 The previous block contains G41 or G42, 323  
 The second auxiliary functions (B codes), 165  
 The tool movement by manual operation, 523  
 There is no inner intersection, 309  
 Thread cutting (G33), 84  
 Threading, 244  
 Three basic axes and their parallel axes, 256  
 Three-dimensional coordinate conversion (G68, G69), 253  
 Three-dimensional tool compensation (G40, G41), 355  
 Three-dimensional tool compensation vector, 356  
 Tilting, 914  
 Time information, 389  
 Time settings, 854  
 Timing for displaying an alarm, 678  
 Tool axis direction, 592, 596  
 Tool axis direction handle feed, 589, 593  
 Tool axis direction handle feed/tool axis direction handle feed B, 589  
 Tool axis normal direction handle feed, 589, 592  
 Tool center path with an intersection, 311  
 Tool center path without an intersection, 312  
 Tool change type A, 158  
 Tool change type B and C, 159  
 Tool change type D, 159  
 Tool changing machining, 917  
 Tool comp., 915, 927  
 Tool compensation, 364  
 Tool compensation memory and the tool compensation value to be entered, 360  
 Tool compensation value, 657  
 Tool compensation values, 388  
 Tool compensation values, number of compensation values, and entering values from the program (G10), 359  
 Tool current position, 916  
 Tool form, 923, 929  
 Tool function (T function), 150  
 Tool group number, 153  
 Tool length measurement, 847  
 Tool length offset (G43,G44,G49), 264  
 Tool length offset cancel, 267  
 Tool length offset command, 58  
 Tool Length/Workpiece Origin Measurement B, 872  
 Tool life, 160  
 Tool life management, 153, 655  
 Tool life management command in a machining program, 157  
 Tool life management function, 152  
 Tool life management screen, 870  
 Tool life value, 153  
 Tool movement around an inner side of a corner ( $180^\circ \leq \alpha$ ), 301  
 Tool movement around an inside corner ( $180^\circ \leq \alpha$ ), 319  
 Tool movement around an outside corner at an acute angle ( $\alpha < 90^\circ$ ), 321  
 Tool movement around an outside corner at an obtuse angle ( $90^\circ \leq \alpha < 180^\circ$ ), 320  
 Tool movement around the inside ( $\alpha < 1^\circ$ ) with an abnormally long vector, linear  $\rightarrow$  linear, 306  
 Tool movement around the inside of a corner ( $180^\circ \leq \alpha$ ), 305

Tool movement around the outside corner at an acute angle ( $\alpha < 90^\circ$ ), 308  
 Tool movement around the outside corner at an obtuse angle ( $90^\circ \leq \alpha < 180^\circ$ ), 307  
 Tool movement around the outside linear  $\rightarrow$  linear at an acute angle less than 1 degree ( $\alpha < 1^\circ$ ), 322  
 Tool movement around the outside of a corner at an obtuse angle ( $90^\circ \leq \alpha < 180^\circ$ ), 302  
 Tool movement around the outside of an acute angle ( $\alpha < 90^\circ$ ), 303  
 Tool movement by programing – automatic operation, 524  
 Tool movement in offset mode, 305  
 Tool movement in offset mode cancel, 319  
 Tool movement in start-up, 301  
 Tool number, 153  
 Tool offset, 61  
 Tool offset (G45–G48), 276  
 Tool offset command, 57, 58  
 Tool offset memory, 845  
 Tool offset value, 277  
 Tool path at corner, 965  
 Tool path in a cutting feed, 93  
 Tool selection function, 151  
 Tool withdrawal and return, 644  
 Tool withdrawal and return (G10.6), 484  
 Tool withdrawal and return function, 657  
 Transfer speed, 460  
 Transition from the offset cancel mode to the cutter compensation mode (Start up), 283  
 Travel distance 0, 244  
 Travel distance along the drilling axis G90/G91, 187  
 Travel distance display, 640  
 Triplane view drawing, 921  
 Triplane view graphic, 917  
 Turning on the power, 572  
 TV check, 699, 850  
 TV check (Vertical parity check along tape), 172  
 Two-path control function, 513  
 Type I (when an interrupt is performed even in the middle of a block), 430  
 Type II (when an interrupt is performed at the end of the block), 431  
 Types, 158  
 Types of variables, 384

**[U]**

Unavailable G codes, 244

Unconditional branch (GOTO statement), 402  
 Undefined variable, 385  
 Unit of graph, 819  
 Unspecifiable functions, 68  
 Usage count, 160  
 Usage time, 160  
 Use of Alkaline Dry Cells (Size D), 945  
 Using a subprogram only, 180  
 Using M99 in the main program, 179

**[V]**

Valid operations, 862  
 Valid range of tool compensation values, 359  
 Variable representation, 384  
 Variables, 384

**[W]**

Waiting for paths, 515  
 Warning for data setting or input/output operation, 896  
 Warning messages, 565  
 What is a file, 690  
 When a movement command in the next block in only one axis, 586  
 When interference is assumed although actual interference does not occur, 329  
 When no retraction distance is specified, 648  
 When reset after a manual operation following a feed hold, 586  
 When the next block involves no movement in cutter compensation C (G41, G42) mode, 421  
 When the next block is not buffered (M codes that are not buffered, G31, etc.), 420  
 When the next move block is an incremental, 586  
 When the same sequence number is found several times in the program, 852  
 When the switch is ON during cutter compensation, 587  
 Withdrawal, 485  
 Without specifying a program number, 775  
 Word search, 757  
 Work coordinate system and graphics, 905  
 Workpiece coordinate system, 123  
 Workpiece coordinate system compensation values (workpiece zero point offset values), 394  
 Writing memo, 691

Revision Record

FANUC Series 16i/18i/160i/180i-MA OPERATOR'S MANUAL (B-63014EN)

|         |           |          |          |         |      |          |  |  |  |
|---------|-----------|----------|----------|---------|------|----------|--|--|--|
|         |           |          |          |         |      |          |  |  |  |
|         |           |          |          |         |      |          |  |  |  |
|         |           |          |          |         |      |          |  |  |  |
|         |           |          |          |         |      |          |  |  |  |
| 01      | Mar., '97 |          |          |         |      |          |  |  |  |
| Edition | Date      | Contents | Contents | Edition | Date | Contents |  |  |  |

- *No part of this manual may be reproduced in any form.*
- *All specifications and designs are subject to change without notice.*